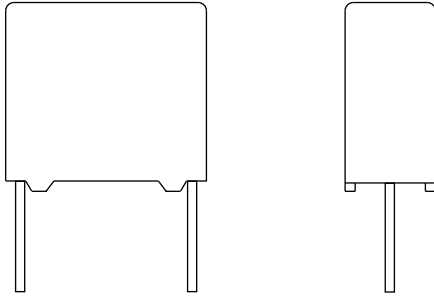

Interference Suppression Film Capacitors MKP Radial Potted Type

FEATURES

- 10 mm to 27.5 mm lead pitch
- Supplied loose in box, taped on reel
- Material categorization:
For definitions of compliance please see www.vishay.com/doc?99912

RoHS
COMPLIANT

APPLICATIONS

For standard across the line X2 applications

 See also application note: www.vishay.com/doc?28153
QUICK REFERENCE DATA

Capacitance range (E12 series)	0.001 μ F to 2.2 μ F (preferred values acc. to E6)
Capacitance tolerance	$\pm 20\%$; $\pm 10\%$; $\pm 5\%$
Climatic testing class according to IEC 60068-1	55/110/56/B
Rated AC voltage	310 V _{AC} ; 50 Hz to 60 Hz
Permissible DC voltage	800 V _{DC} at 85 °C, 630 V _{DC} at 110 °C
Maximum application temperature	C \leq 470 nF: 110 °C (125 °C for less than 1000 h), C > 470 nF: 110 °C
Reference standards	IEC 60384-14 ed 3 and EN60384-14 IEC 60065, pass. flamm. class B for volumes > 1750 mm ³ CQC UL 60384-14; CSA E384-14
Dielectric	Polypropylene film
Electrodes	Metallized film
Construction	Mono construction 
Encapsulation	Plastic case, epoxy resin sealed, flame retardant UL-class 94 V-0
Leads	Tinned wire
Marking	C-value; tolerance; rated voltage; sub-class; manufacturer's type designation; code for dielectric material; manufacturer location; manufacturer's logo; year and week; safety approvals

Note

- For more detailed data and test requirements, contact: rfi@vishay.com

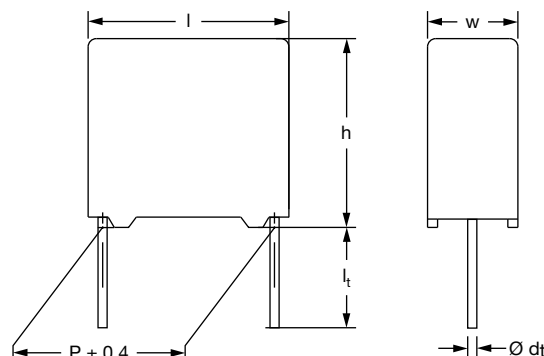
DIMENSIONS in millimeters



COMPOSITION OF CATALOG NUMBER

TYPE AND PITCHES	
336 2	10.0 mm
	15.0 mm
X2	22.5 mm
	27.5 mm

CAPACITANCE
(numerically)

MULTIPLIER (nF)	
0.1	2
1	3
10	4
100	5

Example:
104 = 10 x 10 = 100 nF

BFC2	336	2X	XX	X
2222(*)	336	2X	XX	X

(*) old ordering code

TYPE	PACKAGING	STANDARD DIMENSIONS	C-TOL.	CODE NUMBER	
336 2 X2	Loose in box	Lead length 3.5 mm + 1 mm/- 0.5 mm or 3.5 mm ± 0.3 mm	± 20 %	BFC2 336 20...	
		Lead length 5.0 mm ± 1.0 mm		See tables	
		Lead length 25.0 mm ± 2.0 mm		BFC2 336 26...	
	Taped on reel ⁽¹⁾	H = 18.5 mm; P ₀ = 12.7 mm			BFC2 336 23...
	Loose in box	Loose in box	Lead length 3.5 mm + 1 mm/- 0.5 mm or 3.5 mm ± 0.3 mm	± 10 %	BFC2 336 21...
			Lead length 5.0 mm ± 1.0 mm		See tables
			Lead length 25.0 mm ± 2.0 mm		BFC2 336 27...
	Taped on reel ⁽¹⁾	H = 18.5 mm; P ₀ = 12.7 mm			BFC2 336 24...
	Loose in box	Loose in box	Lead length 3.5 mm + 1 mm/- 0.5 mm or 3.5 mm ± 0.3 mm	± 5 %	BFC2 336 22...
			Lead length 5.0 mm ± 1.0 mm		See tables
			Lead length 25.0 mm ± 2.0 mm		BFC2 336 28...
	Taped on reel ⁽¹⁾	H = 18.5 mm; P ₀ = 12.7 mm			BFC2 336 25...
		PACKAGING	ALTERNATIVE LARGER PITCH SIZES	C-TOL.	CODE NUMBER
	Loose in box	Loose in box	Lead length 3.5 mm + 1 mm/- 0.5 mm or 3.5 mm ± 0.3 mm	± 20 %	See tables for details
Lead length 5.0 mm ± 1.0 mm					
Lead length 25.0 mm ± 2.0 mm					
Taped on reel ⁽¹⁾	H = 18.5 mm; P ₀ = 12.7 mm				
Loose in box	Loose in box	Lead length 3.5 mm + 1 mm/- 0.5 mm or 3.5 mm ± 0.3 mm	± 10 %		
		Lead length 5.0 mm ± 1.0 mm			
		Lead length 25.0 mm ± 2.0 mm			
Taped on reel ⁽¹⁾⁽²⁾	H = 18.5 mm P ₀ = 12.7 mm				

Notes

⁽¹⁾ For detailed tape specifications refer to packaging information: www.vishay.com/doc?28139

⁽²⁾ Taped on reel pitch = 27.5 mm is not available



SPECIFIC REFERENCE DATA		
DESCRIPTION	VALUE	
Rated AC voltage U_{RAC}	310 V	
Permissible DC voltage U_{RDC}	630 V	
Tangent of loss angle:	at 1 kHz	at 10 kHz
$C < 470 \text{ nF}$	$\leq 10 \times 10^{-4}$	$\leq 20 \times 10^{-4}$
$470 \text{ nF} \leq C \leq 1 \mu\text{F}$	$\leq 20 \times 10^{-4}$	$\leq 70 \times 10^{-4}$
$C > 1 \mu\text{F}$	$\leq 30 \times 10^{-4}$	-
Rated voltage pulse slope $(dU/dt)_R$ at 435 V_{DC}	-	
Pitch = 10 mm	600 V/ μs	
Pitch = 15 mm and 7.5 mm (bent back)	400 V/ μs	
Pitch = 22.5 mm	150 V/ μs	
Pitch = 27.5 mm	100 V/ μs	
R between leads, for $C \leq 0.33 \mu\text{F}$ at 100 V; 1 min	$> 15\,000 \text{ M}\Omega$	
RC between leads, for $C > 0.33 \mu\text{F}$ at 100 V; 1 min	$> 5000 \text{ s}$	
R between leads and case; 100 V; 1 min	$> 30\,000 \text{ M}\Omega$	
Withstanding (DC) voltage (cut off current 10 mA) ⁽¹⁾ ; rise time $\leq 1000 \text{ V/s}$:		
$C \leq 1 \mu\text{F}$	2200 V; 1 min	
$C > 1 \mu\text{F}$	1800 V; 1 min	
Withstanding (AC) voltage between leads and case	2120 V; 1 min	
Max. application temperature for $0.001 \mu\text{F} \leq C \leq 0.47 \mu\text{F}$	110 °C (125 °C for less than 1000 h)	
Max. application temperature for $C > 0.47 \mu\text{F}$	110 °C	

Note

⁽¹⁾ See "Voltage Proof Test for Metalized Film Capacitors": www.vishay.com/doc?28169

ELECTRICAL DATA AND ORDERING CODE - PITCH 10 mm											
U_{RAC} (V)	CAP. (μF)	DIMENSIONS w x h x l (mm)	MASS (g) ⁽³⁾	CATALOG NUMBER BFC2 336 AND PACKAGING							
				LOOSE IN BOX					REEL (500 mm) ⁽¹⁾⁽²⁾		
				SHORT LEADS			LONG LEADS		H = 18.5 mm P ₀ = 12.7 mm		
				$l_t = 3.5 \text{ mm}$ + 1 mm/- 0.5 mm	$l_t = 5.0 \text{ mm}$ $\pm 1.0 \text{ mm}$	SPQ	$l_t = 25.0 \text{ mm}$ $\pm 2.0 \text{ mm}$	SPQ		SPQ	
PITCH = 10.0 mm \pm 0.4 mm; $d_t = 0.6 \text{ mm} \pm 0.06 \text{ mm}$; C-TOL. = $\pm 20 \%$											
310	0.0010	4.0 x 10.0 x 12.5	0.6	20102	29131	1000	26102	1000	23102	1400	
	0.0015			20152	29132		26152		1250		23152
	0.0022			20222	29133		26222				23222
	0.0033			20332	29134		26332				23332
	0.0047			20472	29135		26472				23472
	0.0068			20682	29136		26682		1000		23682
	0.010			20103	29137		26103				23103
	0.015			20153	29138		26153				23153
	0.022			20223	29139		26223				23223
	0.033			20333	29141		750		26333		750
PITCH = 10.0 mm \pm 0.4 mm; $d_t = 0.6 \text{ mm} \pm 0.06 \text{ mm}$; C-TOL. = $\pm 10 \%$											
	0.0010	4.0 x 10.0 x 12.5	0.6	21102	29154	1000	27102	1250	24102	1400	
	0.0012			21122	-		27122		24122		
	0.0015			21152	29155		27152		24152		
	0.0018			21182	-		27182		24182		
	0.0022			21222	29156		27222		24222		



ELECTRICAL DATA AND ORDERING CODE - PITCH 10 mm											
U _{RAC} (V)	CAP. (µF)	DIMENSIONS w x h x l (mm)	MASS (g) ⁽³⁾	CATALOG NUMBER BFC2 336 AND PACKAGING							
				LOOSE IN BOX					REEL (500 mm) ⁽¹⁾⁽²⁾		
				SHORT LEADS			LONG LEADS		H = 18.5 mm P ₀ = 12.7 mm		
				l _t = 3.5 mm + 1 mm/- 0.5 mm	l _t = 5.0 mm ± 1.0 mm	SPQ	l _t = 25.0 mm ± 2.0 mm	SPQ		SPQ	
PITCH = 10.0 mm ± 0.4 mm; d _t = 0.6 mm ± 0.06 mm; C-TOL. = ± 10 %											
310	0.0027	4.0 x 10.0 x 12.5	0.6	21272	-		27272		24272	1100	
	0.0033			21332	29157		27332		24332		
	0.0039			21392	-		27392		24392		
	0.0047			21472	29158		27472		24472		
	0.0056			21562	-		27562		24562		
	0.0068			21682	29159	1000	27682	1000	24682		
	0.0082			21822	-		27822		24822		
	0.010			21103	29161		27103		24103		
	0.012			21123	-		27123		24123		
	0.015			21153	29162		27153		24153		
	0.018			21183	-		27183		24183		
	0.022			21223	29163		27223		24223		
	0.027			21273	-	750	27273	750	24273		900
	0.033			21333	29164		27333		24333		
	PITCH = 10.0 mm ± 0.4 mm; d _t = 0.6 mm ± 0.06 mm; C-TOL. = ± 5 %										
	310	0.0010	4.0 x 10.0 x 12.5	0.6	22102	-		28102		25102	1100
		0.0012			22122	-		28122		25122	
		0.0015			22152	-		28152	1250	25152	
0.0018		22182			-		28182		25182		
0.0022		22222			-		28222		25222		
0.0027		22272			-		28272		25272		
0.0033		22332			-		28332		25332		
0.0039		22392			-		28392		25392		
0.0047		22472			-	1000	28472		25472		
0.0056		22562			-		28562		25562		
0.0068		22682			-		28682		25682		
0.0082		22822			-		28822	1000	25822		
0.010		22103			-		28103		25103		
0.012		22123			-		28123		25123		
0.015		22153	-		28153		25153				
0.018		22183	-		28183		25183				
0.022		22223	-		28223		25223				
0.027		22273	-	750	28273	750	25273	900			
0.033	22333	-		28333		25333					

Notes

• SPQ = Standard Packing Quantity

(1) H = In-tape height; P₀ = sprocket hole distance; for detailed specifications refer to packaging information: www.vishay.com/doc?28139

(2) Reel diameter = 356 mm is available on request

(3) Weight for short lead product only



ELECTRICAL DATA AND ORDERING CODE - PITCH 15 mm											
U _{RAC} (V)	CAP. (μF)	DIMENSIONS w x h x l (mm)	MASS (g) ⁽³⁾	CATALOG NUMBER BFC2 336 AND PACKAGING							
				LOOSE IN BOX					REEL (500 mm) ⁽¹⁾⁽²⁾		
				SHORT LEADS			LONG LEADS		H = 18.5 mm P ₀ = 12.7 mm		
				l _t = 3.5 mm ± 0.3 mm	l _t = 5.0 mm ± 1.0 mm	SPQ	l _t = 25.0 mm ± 2.0 mm	SPQ		SPQ	
PITCH = 15 mm ± 0.4 mm; d_t = 0.60 ± 0.06 mm; C-TOL. = ± 20 %											
310	0.010	5.0 x 11.0 x 17.5	0.98	29001	29273	1000	29097	1000	29004	1100	
	0.015			29011	29274		29071		29014		
	0.022			29021	29275		29076		29024		
	0.033			29031	29276		29082		29034		
	0.047			20473	29142		26473		23473		
	0.068			20683	29143		26683		23683		
	0.10	20104	29144	26104	23104	900					
0.15	6.0 x 12.0 x 17.5	1.4	20154	29145		26154	500	23154	650		
PITCH = 15 mm ± 0.4 mm; d_t = 0.80 ± 0.08 mm; C-TOL. = ± 20 %											
	0.22	7.0 x 13.5 x 17.5	1.8	20224	29146	500	26224	500	23224	600	
PITCH = 15 mm ± 0.4 mm; d_t = 0.60 ± 0.06 mm; C-TOL. = ± 10 %											
310	0.010	5.0 x 11.0 x 17.5	0.98	29002	29281	1000	29066	1000	29005	1100	
	0.012			29007	-		29068		29009		
	0.015			29012	29282		29072		29015		
	0.018			29017	-		29074		29019		
	0.022			29022	29283		29077		29025		
	0.027			29027	-		29079		29029		
	0.033			29032	29284		29083		29035		
	0.039			21393	-		27393		24393		
	0.047			21473	29165		27473		24473		
	0.056			21563	-		27563		24563		
	0.068			21683	29166		27683		24683		900
	0.082			21823	-		27823		24823		
	0.10	21104	29167	27104	24104	800					
0.12	6.0 x 12.0 x 17.5	1.4	21124	-		27124	500	24124	650		
0.15			21154	29168		27154		24154			
PITCH = 15 mm ± 0.4 mm; d_t = 0.80 ± 0.08 mm; C-TOL. = ± 10 %											
	0.18	7.0 x 13.5 x 17.5	1.8	21184	-	500	27184	500	24184	600	
	0.22			21224	29169		27224		24224		
PITCH = 15 mm ± 0.4 mm; d_t = 0.60 ± 0.06 mm; C-TOL. = ± 5 %											
310	0.010	5.0 x 11.0 x 17.5	0.98	29003	-	1000	29067	1000	29006	1100	
	0.012			29008	-		29069		29061		
	0.015			29013	-		29073		29016		
	0.018			29018	-		29075		29062		
	0.022			29023	-		29078		29026		
	0.027			29028	-		29081		29063		
	0.033			29033	-		29084		29036		
	0.039			22393	-		28393		25393		
	0.047			22473	-		28473		25473		
	0.056			22563	-		28563		25563		
	0.068			22683	-		28683		25683		900
	0.082			22823	-		28823		25823		
	0.10	22104	-	28104	25104	800					
0.12	6.0 x 12.0 x 17.5	1.4	22124	-		28124	500	25124	650		
0.15			22154	-		28154		25154			
PITCH = 15 mm ± 0.4 mm; d_t = 0.80 ± 0.08 mm; C-TOL. = ± 5 %											
	0.18	7.0 x 13.5 x 17.5	1.8	22184	-	500	28184	500	25184	600	

Notes

• SPQ = Standard Packing Quantity

(1) H = In-tape height; P₀ = sprocket hole distance; for detailed specifications refer to packaging information: www.vishay.com/doc?28139

(2) Reel diameter = 356 mm is available on request

(3) Weight for short lead product only



ELECTRICAL DATA AND ORDERING CODE - PITCH 22.5 mm											
U _{RAC} (V)	CAP. (μF)	DIMENSIONS w x h x l (mm)	MASS (g) ⁽³⁾	CATALOG NUMBER BFC2 336 AND PACKAGING							
				LOOSE IN BOX					REEL (500 mm) ⁽¹⁾⁽²⁾		
				SHORT LEADS			LONG LEADS		H = 18.5 mm P ₀ = 12.7 mm		
				l _t = 3.5 mm ± 0.3 mm	l _t = 5.0 mm ± 1.0 mm	SPQ	l _t = 25.0 mm ± 2.0 mm	SPQ		SPQ	
PITCH = 22.5 mm ± 0.4 mm; d_t = 0.80 mm ± 0.08 mm; C-TOL. = ± 20 %											
310	0.15	6.0 x 15.5 x 26.0	2.4	29041	29277	300	29087	500	29044	600	
	0.22			29051	29278		29093		29053	550	
	0.33			20334	29147		26334		23334	450	
	0.47	7.0 x 16.5 x 26.0	2.9	20474	29148	200	26474	500	23474	400	
PITCH = 22.5 mm ± 0.4 mm; d_t = 0.80 mm ± 0.08 mm; C-TOL. = ± 10 %											
310	0.12	6.0 x 15.5 x 26.0	2.4	29037	-	300	29085	500	29039	600	
	0.15			29042	29285		29088		29045		
	0.18			29047	-		29091		29049		
	0.22			29052	29286		29094		29054		
	0.27			21274	-		27274		24274		
	0.33	21334	29171	27334	24334	450					
	0.39	7.0 x 16.5 x 26.0	2.9	21394	-	200	27394	500	24394	400	
	0.47			21474	29172		27474		24474		
	PITCH = 22.5 mm ± 0.4 mm; d_t = 0.80 mm ± 0.08 mm; C-TOL. = ± 5 %										
	310	0.12	6.0 x 15.5 x 26.0	2.4	29038	-	300	29086	500	29064	600
0.15		29043			-	29089		29046			
0.18		29048			-	29092		29065			
0.22		22224			-	28224		25224			
0.27		22274	-	28274	25274	450					
0.33		7.0 x 16.5 x 26.0	2.9	22334	-		200	28334	500	25334	
0.39				22394	-	28394		25394		400	

Notes

- SPQ = Standard Packing Quantity

⁽¹⁾ H = In-tape height; P₀ = sprocket hole distance; for detailed specifications refer to packaging information: www.vishay.com/doc?28139

⁽²⁾ Reel diameter = 356 mm is available on request



⁽³⁾ Weight for short lead product only



ELECTRICAL DATA AND ORDERING CODE - PITCH 27.5 mm								
U _{RAC} (V)	CAP. (μF)	DIMENSIONS w x h x l (mm)	MASS (g) ⁽¹⁾	CATALOG NUMBER BFC2 336 AND PACKAGING				
				LOOSE IN BOX				
				SHORT LEADS			LONG LEADS	
				l _t = 3.5 mm ± 0.3 mm	l _t = 5.0 mm ± 1.0 mm	SPQ	l _t = 25.0 mm ± 2.0 mm	SPQ
PITCH = 27.5 mm ± 0.4 mm; d_t = 0.80 mm ± 0.08 mm; C-TOL. = ± 20 %								
0.47	9.0 x 19.0 x 31.5	9.0 x 19.0 x 31.5	5.5	29055	29279	100	29095	150
0.68				20684	29149		26684	125
1.0	11.0 x 21.0 x 31.0	7.4	20105	29151	26105			
1.5	13.0 x 23.0 x 31.0	9.2	20155	29152	26155			
2.2	15.0 x 25.0 x 31.5	12.3	20225	29153	26225	75		
PITCH = 27.5 mm ± 0.4 mm; d_t = 0.80 mm ± 0.08 mm; C-TOL. = ± 10 %								
0.47	9.0 x 19.0 x 31.5	9.0 x 19.0 x 31.5	5.5	29056	29287	100	29096	150
0.56				21564	-		27564	125
0.68	21684	29173	27684					
0.82	11.0 x 21.0 x 31.0	11.0 x 21.0 x 31.0	7.4	21824	-	27824		
1.0				21105	29174	27105		
1.2	13.0 x 23.0 x 31.0	13.0 x 23.0 x 31.0	9.2	21125	-	27125		
1.5				21155	29175	27155		
1.8	15.0 x 25.0 x 31.5	15.0 x 25.0 x 31.5	12.3	21185	-	27185	75	
2.2				21225	29176	27225		
PITCH = 27.5 mm ± 0.4 mm; d_t = 0.80 mm ± 0.08 mm; C-TOL. = ± 5 %								
0.47	9.0 x 19.0 x 31.5	9.0 x 19.0 x 31.5	5.5	22474	-	100	28474	125
0.56				22564	-		28564	
0.68	22684	-	28684					
0.82	11.0 x 21.0 x 31.0	11.0 x 21.0 x 31.0	7.4	22824	-	28824		
1.0				22105	-	28105		
1.2	13.0 x 23.0 x 31.0	13.0 x 23.0 x 31.0	9.2	22125	-	28125		
1.5				22155	-	28155		
1.8	15.0 x 25.0 x 31.5	15.0 x 25.0 x 31.5	12.3	22185	-	28185	75	
2.2				22225	-	28225		

Notes

- SPQ = Standard Packing Quantity
- ⁽¹⁾ Weight for short lead product only

APPROVALS			
SAFETY APPROVALS X2	VOLTAGE	VALUE	FILE NUMBERS
EN60384-14 (ENEC) (= IEC 60384-14)	310 V _{AC}	1 nF to 2.2 μF	FI 2008038 A1
UL 60384-14	310 V _{AC}	1 nF to 2.2 μF	E354331
CSA-E 384-14	310 V _{AC}	1 nF to 2.2 μF	E354331
CQC	310 V _{AC}	1 nF to 2.2 μF	CQC07001021280 (L)
			CQC04001009262 (F)
CB test certificate	310 V _{AC}	1 nF to 2.2 μF	FI 5123 A1
The ENEC-approval together with the CB-certificate replace all national marks of the following countries (they have already signed the ENEC-agreement): Austria; Belgium; Czech. Republic; Denmark; Finland; France; Germany; Greece; Hungary; Ireland; Italy; Luxembourg; Netherlands; Norway; Portugal; Slovenian; Spain; Sweden; Switzerland and United Kingdom.			
  			

MOUNTING

Normal Use

The capacitors are designed for mounting on printed-circuit boards. The capacitors packed in bandoliers are designed for mounting in printed-circuit boards by means of automatic insertion machines.

For detailed tape specifications refer to packaging information: www.vishay.com/doc?28139

Specific Method of Mounting to Withstand Vibration and Shock

In order to withstand vibration and shock tests, it must be insured that the stand-off pips are in good contact with the printed circuit board:

- For pitches ≤ 15 mm capacitors shall be mechanically fixed by the leads
- For larger pitches the capacitors shall be mounted in the same way and the body clamped.

Space Requirements on Printed Circuit Board

The maximum space for length (l_{max}), width (w_{max}) and height (h_{max}) of film capacitors to take in account on the printed circuit board is shown in the drawings.

- For products with pitch ≤ 15 mm, $\Delta w = \Delta l = 0.3$ mm; $\Delta h = 0.1$ mm
- For products with 15 mm $<$ pitch ≤ 27.5 mm, $\Delta w = \Delta l = 0.5$ mm; $\Delta h = 0.1$ mm

Eccentricity defined as in drawing. The maximum eccentricity is smaller than or equal to the lead diameter of the product concerned.

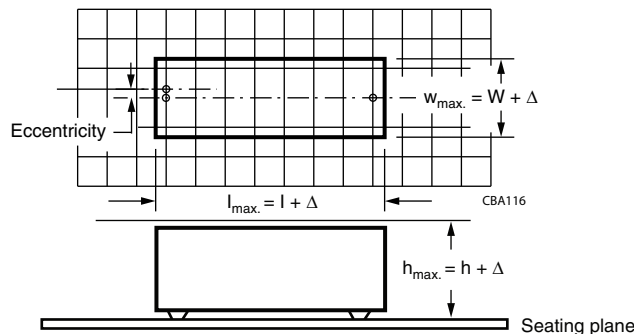

SOLDERING CONDITIONS

For general soldering conditions and wave soldering profile, we refer to the application note: "Soldering Guidelines for Film Capacitors": www.vishay.com/doc?28171

Storage Temperature

$T_{stg} = -25$ °C to $+35$ °C with RH maximum 75 % without condensation

Ratings and Characteristics Reference Conditions

Unless otherwise specified, all electrical values apply to an ambient temperature of 23 °C ± 1 °C, an atmospheric pressure of 86 kPa to 106 kPa and a relative humidity of 50 % ± 2 %.

For reference testing, a conditioning period shall be applied over 96 h ± 4 h by heating the products in a circulating air oven at the rated temperature and a relative humidity not exceeding 20 %.



CHARACTERISTICS

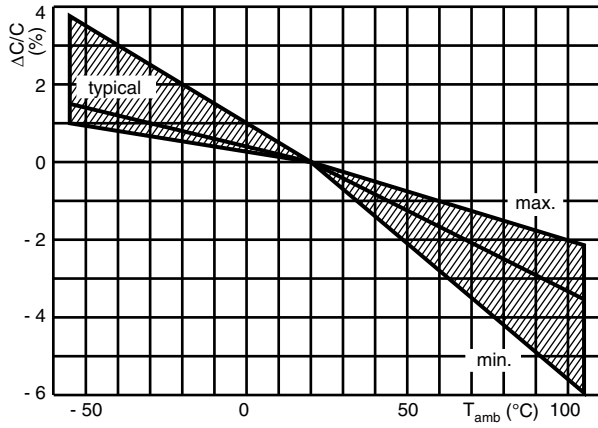

Capacitance as a function of ambient temperature (typical curve)

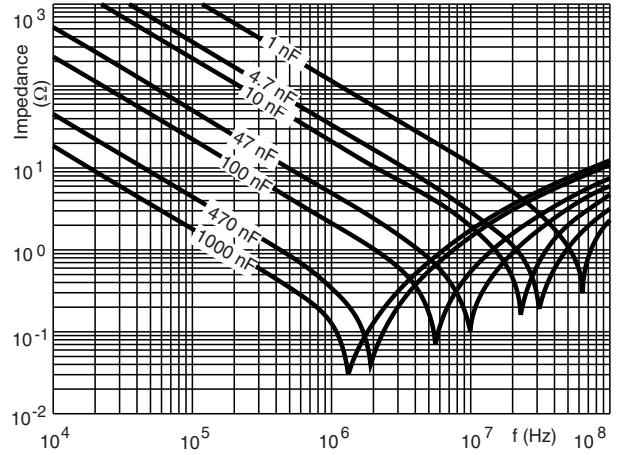

Impedance as a function of frequency (typical curve)

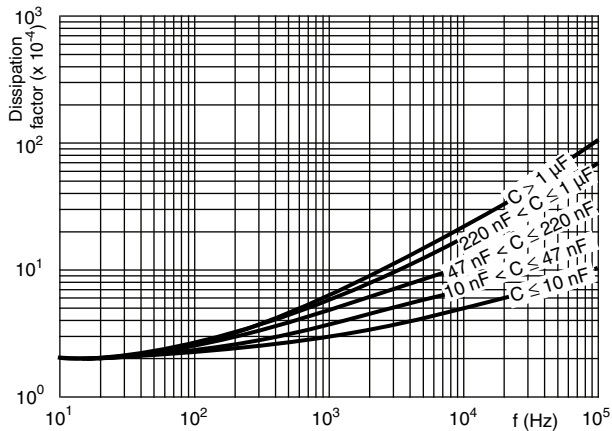

Tangent of loss angle as a function of frequency (typical curve)

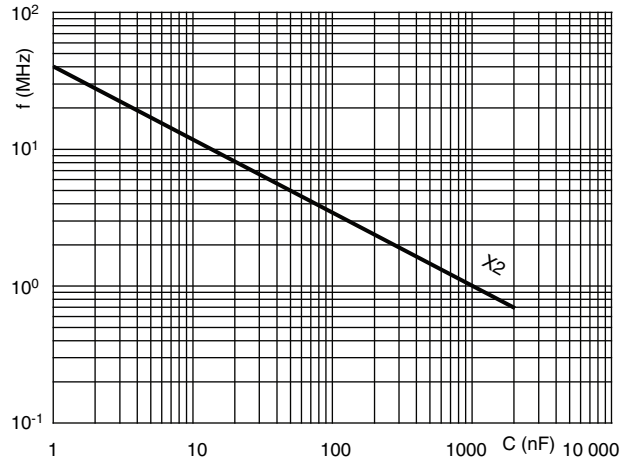

Resonant frequency as a function of capacitance (typical curve)

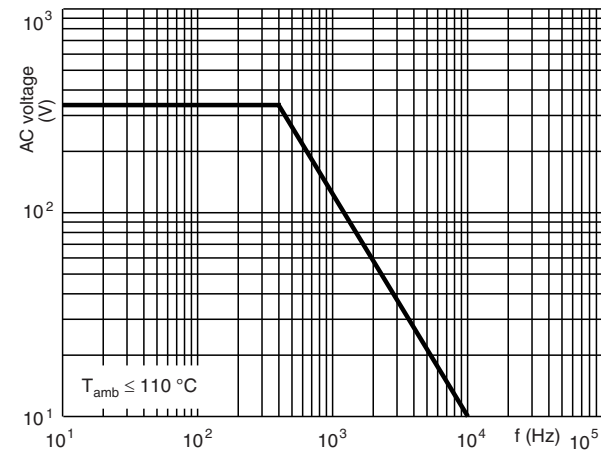

Max. RMS voltage as a function of frequency (typical curve)

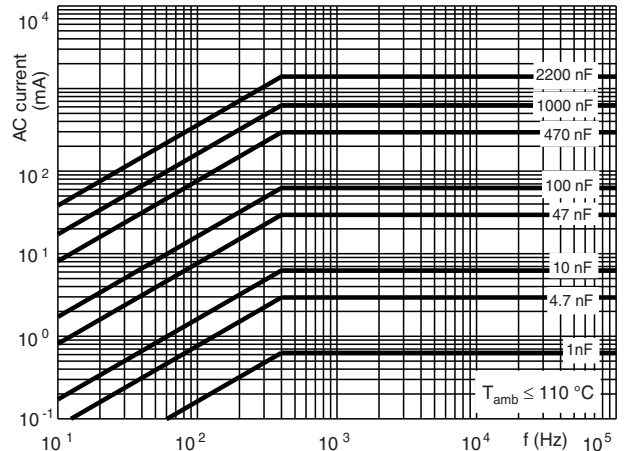

Max. RMS current as a function of frequency (typical curve)

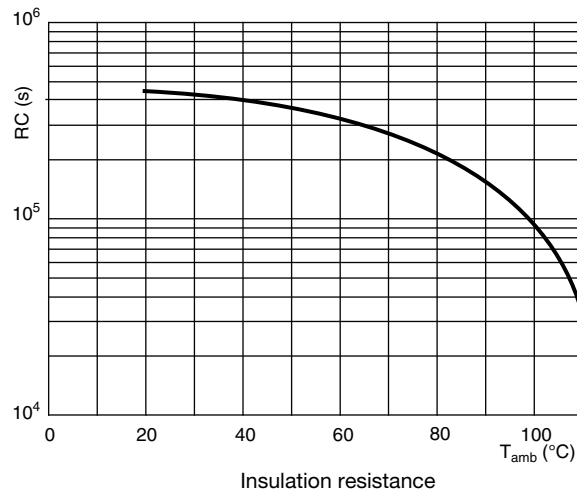

APPLICATION NOTES

- For X2 electromagnetic interference suppression in **standard across the line applications** (50/60 Hz) with a maximum mains voltage of 310 V_{AC}.
- For series impedance applications we refer to the application note www.vishay.com/doc?28153
- For capacitors connected in parallel, normally the proof voltage and possibly the rated voltage must be reduced. For information depending of the capacitance value and the number of parallel connections contact: rfi@vishay.com.
- These capacitors are not intended for continuous pulse applications. For these situations, capacitors of the AC and pulse programs must be used.
- The maximum ambient temperature must not exceed 110 °C (125 °C for less than 1000 h) for C ≤ 470 nF and 110 °C for C > 470 nF
- Rated voltage pulse slope:
If the pulse voltage is lower than the rated voltage, the values of the specific reference data can be multiplied by 435 V_{DC} and divided by the applied voltage

INSPECTION REQUIREMENTS

General Notes

Sub-clause numbers of tests and performance requirements refer to the “Sectional Specification, IEC Publication IEC 60384-14 ed 3 and Specific Reference Data”.

GROUP C INSPECTION REQUIREMENTS		
SUB-CLAUSE NUMBER AND TEST	CONDITIONS	PERFORMANCE REQUIREMENTS
SUB-GROUP C1A PART OF SAMPLE OF SUB-GROUP C1		
4.1 Dimensions (detail)		As specified in chapters “General Data” of this specification
Initial measurements	Capacitance Tangent of loss angle: For C ≤ 1 μF at 10 kHz For C > 1 μF at 1 kHz	
4.3 Robustness of terminations	Tensile: Load 10 N; 10 s Bending: Load 5 N; 4 x 90°	No visible damage
4.4 Resistance to soldering heat	No pre-drying Method: 1A Solder bath: 280 °C ± 5 °C Duration: 10 s	



GROUP C INSPECTION REQUIREMENTS		
SUB-CLAUSE NUMBER AND TEST	CONDITIONS	PERFORMANCE REQUIREMENTS
SUB-GROUP C1A PART OF SAMPLE OF SUB-GROUP C1		
4.19 Component solvent resistance	Isopropylalcohol at room temperature Method: 2 Immersion time: 5 min ± 0.5 min Recovery time: Min. 1 h, max. 2 h	
4.4.2 Final measurements	Visual examination Capacitance Tangent of loss angle Insulation resistance	No visible damage Legible marking $ \Delta C/C \leq 5\%$ of the value measured initially Increase of $\tan \delta$: ≤ 0.008 for: $C \leq 1 \mu F$ or ≤ 0.005 for: $C > 1 \mu F$ Compared to values measured initially As specified in section "Insulation resistance" of this specification
SUB-GROUP C1B PART OF SAMPLE OF SUB-GROUP C1		
Initial measurements	Capacitance Tangent of loss angle: For $C \leq 1 \mu F$ at 10 kHz For $C > 1 \mu F$ at 1 kHz	
4.20 Solvent resistance of the marking: see section "General notes"; item 5	Isopropylalcohol at room temperature Method: 1 Rubbing material: Cotton wool Immersion time: 5 min ± 0.5 min	No visible damage Legible marking
4.6 Rapid change of temperature	$\theta A = -55\text{ }^\circ C$ $\theta B = +110\text{ }^\circ C$ 5 cycles Duration $t = 30$ min	
4.6.1 Inspection	Visual examination	No visible damage
4.7 Vibration	Mounting: See section "Mounting" of this specification Procedure B4 Frequency range: 10 Hz to 55 Hz Amplitude: 0.75 mm or Acceleration 98 m/s ² (whichever is less severe) Total duration 6 h	
4.7.2 Final inspection	Visual examination	No visible damage
4.9 Shock	Mounting: See section "Mounting" for more information Pulse shape: Half sine Acceleration: 490 m/s ² Duration of pulse: 11 ms	



GROUP C INSPECTION REQUIREMENTS		
SUB-CLAUSE NUMBER AND TEST	CONDITIONS	PERFORMANCE REQUIREMENTS
SUB-GROUP C1B PART OF SAMPLE OF SUB-GROUP C1		
4.9.2 Final measurements	Visual examination Capacitance Tangent of loss angle Insulation resistance	No visible damage $ \Delta C/C \leq 5\%$ of the value measured initially Increase of $\tan \delta$: ≤ 0.008 for: $C \leq 1 \mu\text{F}$ or ≤ 0.005 for: $C > 1 \mu\text{F}$ Compared to values measured initially As specified in section "Insulation resistance" of this specification
SUB-GROUP C1 COMBINED SAMPLE OF SPECIMENS OF SUB-GROUPS C1A AND C1B		
4.11 Climatic sequence		
4.11.1 Initial measurements	Capacitance Measured in 4.4.2 and 4.9.2 Tangent of loss angle: Measured initially in C1A and C1B	
4.11.2 Dry heat	Temperature: 110 °C	
4.11.3 Damp heat cyclic Test Db First cycle	Duration: 16 h	
4.11.4 Cold	Temperature: - 55 °C	
4.11.5 Damp heat cyclic Test Db remaining cycles	Duration: 2 h	
4.11.6 Final measurements	Visual examination Capacitance Tangent of loss angle Voltage proof 1350 V _{DC} ; 1 min between terminations Insulation resistance	No visible damage Legible marking $ \Delta C/C \leq 5\%$ of the value measured in 4.11.1. Increase of $\tan \delta$: ≤ 0.008 for: $C \leq 1 \mu\text{F}$ or ≤ 0.005 for: $C > 1 \mu\text{F}$ Compared to values measured in 4.11.1. No permanent breakdown or flash-over $\geq 50\%$ of values specified in section "Insulation resistance" of this specification
SUB GROUP C2		
4.12 Damp heat steady state	56 days, 40 °C, 90 % to 95 % RH No load	
4.12.1 Initial measurements	Capacitance Tangent of loss angle at 1 kHz	

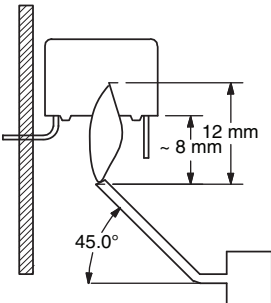

GROUP C INSPECTION REQUIREMENTS		
SUB-CLAUSE NUMBER AND TEST	CONDITIONS	PERFORMANCE REQUIREMENTS
SUB GROUP C2		
4.12.3 Final measurements	Visual examination Capacitance Tangent of loss angle Voltage proof 1350 V _{DC} ; 1 min between terminations Insulation resistance	No visible damage Legible marking $ \Delta C/C \leq 5\%$ of the value measured in 4.12.1. Increase of tan δ : ≤ 0.008 for: $C \leq 1 \mu\text{F}$ or ≤ 0.005 for: $C > 1 \mu\text{F}$ Compared to values measured in 4.12.1. No permanent breakdown or flash-over $\geq 50\%$ of values specified in section "Insulation resistance" of this specification
SUB-GROUP C3		
4.13.1 Initial measurements	Capacitance Tangent of loss angle: For $C \leq 1 \mu\text{F}$ at 10 kHz For $C > 1 \mu\text{F}$ at 1 kHz	
4.13 Impulse voltage	3 successive impulses, full wave, peak voltage: 2.5 kV for $C \leq 1 \mu\text{F}$ 2.5 kV/ \sqrt{C} for $C > 1 \mu\text{F}$ Max. 24 pulses	No selfhealing breakdowns or flashover
4.14 Endurance	Duration: 1000 h 1.25 x U _{RAC} at 110 °C Once in every hour the voltage is increased to 1000 V _{RMS} for 0.1 s via resistor of 47 $\Omega \pm 5\%$	
4.14.7 Final measurements	Visual examination Capacitance Tangent of loss angle Voltage proof 1350 V _{DC} ; 1 min between terminations 2120 V _{AC} ; 1 min between terminations and case Insulation resistance	No visible damage Legible marking $ \Delta C/C \leq 10\%$ compared to values measured in 4.13.1. Increase of tan δ : ≤ 0.008 for: $C \leq 1 \mu\text{F}$ or ≤ 0.005 for: $C > 1 \mu\text{F}$ Compared to values measured in 4.13.1. No permanent breakdown or flash-over $\geq 50\%$ of values specified in section "Insulation resistance" of this specification
SUB-GROUP C4		
4.15 Charge and discharge	10 000 cycles Charged to 435 V _{DC} Discharge resistance: $R = \frac{435 V_{DC}}{1.25 \times C (dU/dt)}$	

GROUP C INSPECTION REQUIREMENTS		
SUB-CLAUSE NUMBER AND TEST	CONDITIONS	PERFORMANCE REQUIREMENTS
SUB-GROUP C4		
4.15.1 Initial measurements	Capacitance Tangent of loss angle: For $C \leq 1 \mu\text{F}$ at 10 kHz For $C > 1 \mu\text{F}$ at 1 kHz	
4.15.3 Final measurements	Capacitance Tangent of loss angle Insulation resistance	$ \Delta C/C \leq 10\%$ compared to values measured in 4.15.1. Increase of $\tan \delta$: ≤ 0.008 for: $C \leq 1 \mu\text{F}$ or ≤ 0.005 for: $C > 1 \mu\text{F}$ Compared to values measured in 4.15.1. $\geq 50\%$ of values specified in section "Insulation resistance" of this specification
SUB-GROUP C5		
4.16 Radio frequency characteristic	Resonance frequency	≥ 0.9 times the value as specified in section "Resonant frequency" of this specification
SUB-GROUP C6		
4.17 Passive flammability Class B	Bore of gas jet: $\varnothing 0.5 \text{ mm}$ Fuel: Butane Test duration for actual volume V in mm^3 : $V \leq 250$: 10 s $250 < V \leq 500$: 20 s $500 < V \leq 1750$: 30 s $V > 1750$: 60 s One flame application 	After removing test flame from capacitor, the capacitor must not continue to burn for more than 10 s. No burning particle must drop from the sample.
SUB-GROUP C7		
4.18 Active flammability	20 cycles of 2.5 kV discharges on the test capacitor connected to U_{RAC} .	The cheese cloth around the capacitors shall not burn with a flame. No electrical measurements are required.



Disclaimer

ALL PRODUCT, PRODUCT SPECIFICATIONS AND DATA ARE SUBJECT TO CHANGE WITHOUT NOTICE TO IMPROVE RELIABILITY, FUNCTION OR DESIGN OR OTHERWISE.

Vishay Intertechnology, Inc., its affiliates, agents, and employees, and all persons acting on its or their behalf (collectively, "Vishay"), disclaim any and all liability for any errors, inaccuracies or incompleteness contained in any datasheet or in any other disclosure relating to any product.

Vishay makes no warranty, representation or guarantee regarding the suitability of the products for any particular purpose or the continuing production of any product. To the maximum extent permitted by applicable law, Vishay disclaims (i) any and all liability arising out of the application or use of any product, (ii) any and all liability, including without limitation special, consequential or incidental damages, and (iii) any and all implied warranties, including warranties of fitness for particular purpose, non-infringement and merchantability.

Statements regarding the suitability of products for certain types of applications are based on Vishay's knowledge of typical requirements that are often placed on Vishay products in generic applications. Such statements are not binding statements about the suitability of products for a particular application. It is the customer's responsibility to validate that a particular product with the properties described in the product specification is suitable for use in a particular application. Parameters provided in datasheets and/or specifications may vary in different applications and performance may vary over time. All operating parameters, including typical parameters, must be validated for each customer application by the customer's technical experts. Product specifications do not expand or otherwise modify Vishay's terms and conditions of purchase, including but not limited to the warranty expressed therein.

Except as expressly indicated in writing, Vishay products are not designed for use in medical, life-saving, or life-sustaining applications or for any other application in which the failure of the Vishay product could result in personal injury or death. Customers using or selling Vishay products not expressly indicated for use in such applications do so at their own risk. Please contact authorized Vishay personnel to obtain written terms and conditions regarding products designed for such applications.

No license, express or implied, by estoppel or otherwise, to any intellectual property rights is granted by this document or by any conduct of Vishay. Product names and markings noted herein may be trademarks of their respective owners.

Material Category Policy

Vishay Intertechnology, Inc. hereby certifies that all its products that are identified as RoHS-Compliant fulfill the definitions and restrictions defined under Directive 2011/65/EU of The European Parliament and of the Council of June 8, 2011 on the restriction of the use of certain hazardous substances in electrical and electronic equipment (EEE) - recast, unless otherwise specified as non-compliant.

Please note that some Vishay documentation may still make reference to RoHS Directive 2002/95/EC. We confirm that all the products identified as being compliant to Directive 2002/95/EC conform to Directive 2011/65/EU.

Vishay Intertechnology, Inc. hereby certifies that all its products that are identified as Halogen-Free follow Halogen-Free requirements as per JEDEC JS709A standards. Please note that some Vishay documentation may still make reference to the IEC 61249-2-21 definition. We confirm that all the products identified as being compliant to IEC 61249-2-21 conform to JEDEC JS709A standards.



Компания «ЭлектроПласт» предлагает заключение долгосрочных отношений при поставках импортных электронных компонентов на взаимовыгодных условиях!

Наши преимущества:

- Оперативные поставки широкого спектра электронных компонентов отечественного и импортного производства напрямую от производителей и с крупнейших мировых складов;
- Поставка более 17-ти миллионов наименований электронных компонентов;
- Поставка сложных, дефицитных, либо снятых с производства позиций;
- Оперативные сроки поставки под заказ (от 5 рабочих дней);
- Экспресс доставка в любую точку России;
- Техническая поддержка проекта, помощь в подборе аналогов, поставка прототипов;
- Система менеджмента качества сертифицирована по Международному стандарту ISO 9001;
- Лицензия ФСБ на осуществление работ с использованием сведений, составляющих государственную тайну;
- Поставка специализированных компонентов (Xilinx, Altera, Analog Devices, Intersil, Interpoint, Microsemi, Aeroflex, Peregrine, Syfer, Eurofarad, Texas Instrument, Miteq, Cobham, E2V, MA-COM, Hittite, Mini-Circuits, General Dynamics и др.);

Помимо этого, одним из направлений компании «ЭлектроПласт» является направление «Источники питания». Мы предлагаем Вам помощь Конструкторского отдела:

- Подбор оптимального решения, техническое обоснование при выборе компонента;
- Подбор аналогов;
- Консультации по применению компонента;
- Поставка образцов и прототипов;
- Техническая поддержка проекта;
- Защита от снятия компонента с производства.



Как с нами связаться

Телефон: 8 (812) 309 58 32 (многоканальный)

Факс: 8 (812) 320-02-42

Электронная почта: org@eplast1.ru

Адрес: 198099, г. Санкт-Петербург, ул. Калинина, дом 2, корпус 4, литера А.