



## Order numbering code

### Type No.

3120 thermal rocker-actuated circuit breaker

#### Mounting method

**F** flange mounting snap-in frame

#### Size of frame

- 3** standard, to fit mounting cut-out 50.5 x 21.5 mm
- 5** standard, to fit mounting cut-out 44.5 x 22 mm
- 7** special style, to fit mounting cut-out 44.5 x 22 mm

#### Number of poles

- 1** 1-pole, thermally protected
- 2** 2-pole, thermally protected
- 5** 2-pole, 1-pole thermally protected

#### Mounting frame design (F3 & F5)

- 1** collar height 1 mm
- 3** collar height 9 mm
- 4** collar height 2 mm with water splash protection (IP54)

#### Mounting frame design (F7)

- R** black
- T** black with snap-on water splash cover

#### Terminal configuration

- PT** push-in terminals
- P7** blade terminals
- H7** as P7, terminals 11 and 21 with flat head screws M3.5 - standard for units with undervoltage release module
- N7** as P7, with additional shunt terminals 12(i) and 22(i)
- G7** as N7, terminals 11 and 21 with flat head screws M3.5

#### Characteristic curve

**T1** thermal trip

#### Actuator style

- W** rocker for frame size F3 & F5
- A** rocker for frame size F7

#### Colour and illumination

- 01.** rocker black opaque
- 02.** rocker white opaque
- 04.** rocker red opaque
- 14. R** rocker red translucent with LED illumination
- 15. Y** rocker orange translucent with LED illumination
- 19. G** rocker green translucent with LED illumination

#### Marking for rocker style W



#### Marking for rocker style A

»|« and »0« moulded in

#### Illumination voltage range

(= operating voltage)

- 1** DC 12 V
- 2** DC 24 V
- 3** AC 115 V
- 4** AC 230 V
- 5** DC 48 V

3120 - F 7 2 R - P7 T1 - A 14 QR 4

#### Current ratings

0.1...20 A

3120 - F 7 2 R - P7 T1 - A 14 QR 4 - 10 A ordering example

## Order numbering code

### Type No.

3120 thermal circuit breaker with push button actuation

#### Mounting

**F** flange mounting snap-in frame

#### Size

- 2** special frame for fitting splash cover
- 3** mounting cut-out 50.5 x 21.5 mm (panel thickness 1-6.35 mm)

#### Number of poles

- 1** 1-pole, thermally protected
- 2** 2-pole, thermally protected
- 5** 2-pole, 1-pole thermally protected

#### Style

- F** frame with 2 push buttons
- G** frame with one push button (reset only)

#### Terminal configuration

- PT** push-in terminals
- P7** blade terminals
- H7** as P7, terminals 11 and 21 with flat head screws M3.5 - standard for units with undervoltage release module
- N7** as P7, with additional shunt terminals 12(i) and 22(i)
- G7** as N7, terminals 11 and 21 with flat head screws M3.5

#### Characteristic curve

**T1** thermal trip

#### Actuators / colour / illumination

- D01X** 1 push button\* black opaque
- D02X** 1 push button\* white opaque
- D04X** 1 push button\* red opaque
- D19XG** 1 push button\* green translucent with LED illumination
- SGRX** 2 push buttons green/red opaque without illumination
- SGRXG** 2 push buttons green/red translucent with LED illumination

#### Illumination voltage range

(= operating voltage)

- 1** DC 12 V
- 2** DC 24 V
- 3** AC 115 V
- 4** AC 230 V
- 5** DC 48 V

#### Current ratings

0.1...20 A

3120 - F 3 2 F - P7 T1 - S GRXG 4-10 A ordering example

\*reset only

#### Packaging unit:

20, 25, 35, 50 or 60 pcs, depending on the version

## Preferred types

preferred type F7 2-pole protected	preferred ratings (A)															
	0.5	1	1.5	2	3	4	5	6	8	10	12	15	16	20		
3120-F72R-P7T1-A14QR4-	x	x	x	x	x	x	x	x	x	x	x	x	x	x	x	
preferred type F3 1-pole protected	0.5	1	2	3	4	5	6	8	10	12	15	16	20			
3120-F311-P7T1-W02D-		x			x	x	x	x	x		x		x			
preferred type F3 2-pole protected	0.5	1	2	3	4	5	6	8	10	12	15	16	20			
3120-F321-P7T1-W01D-	x	x	x	x	x	x	x	x	x	x	x	x	x			
preferred type F5 2-pole protected	0.5	1	2	3	4	5	6	8	10	12	15	16	20			
3120-F521-P7T1-W01D-		x	x	x	x	x	x	x	x	x	x	x	x			

## Approvals

Approval authority	Standard	Rated voltage	Current rating range
VDE	IEC/EN 60934	AC 240 V DC 50 V DC 50 V DC 28 V	0,1 A...20 A 0,1...20A (2-pole) 0,1...4 A (1-pole) 0,1 A...20 A
UL	UL 1077	AC 250 V DC 50 V AC 250 V	0,1 A...20 A 0,1 A...20 A 30 A (2 poles in parallel)
CSA	C22.2 No 235	AC 250 V DC 50 V AC 250 V	0,1 A...20 A 0,1 A...20 A 30 A (2 poles in parallel)
CQC	GB 17701	AC 240 V DC 50 V	0,1 A...20 A 0,1 A...20 A

## Schematic diagrams

**2-pole, thermally protected on both poles**      **2-pole, thermally protected on one pole only**



**1-pole, thermally protected**



## Time/current characteristics

single or double pole load

**0.1...2 A**



**2.5...20 A**



The time/current characteristic depends on the ambient temperature. In order to eliminate nuisance tripping, please multiply the current rating by a derating factor (see chapter Technical Information)

ambient temperature [°C]	-30	-20	-10	0	23	40	50	60
Temperature factor	0.8	0.84	0.88	0.92	1	1.08	1.14	1.23

## Dimensions

**3120-F2.F-...**



**3120-F2.F-PT...**



**3120-F3.1**



**3120-F3.1-PT**



**3120-F 3.3**  
collar height 9 mm



**3120-F 3.4**  
with water splash protection (IP54)



**Dimensions**

**3120-F3.F-...-S...**



**3120-F3.G-...-D...**



**3120-F 5.1**



**3120-F5.1-PT**



**3120-F5.3**



**3120-F5.4**



1

## Dimensions

### Style F7.R



### 3120-F7.R-PT



### Style F7.T



## Cut-out dimensions

### 3120-F2...



### Cut-out for mounting style -F3 with rocker and push button



### Cut-out for mounting style -F5/-F7 with rocker



Edges of working parts: ISO 13715

## Cable cross sections PT terminals

cable	cross section with direct push-in wiring
rigid	1...4 mm <sup>2</sup> (stripping length: 10 mm)
flexible with wire end ferrule (with or without plastic sleeve)	0.5...2.5 mm <sup>2</sup>
cable	cross section when opening the push-in terminals
rigid	0.5...4 mm <sup>2</sup> (stripping length: 10 mm)
flexible without wire end ferrule	0.5...2.5 mm <sup>2</sup>

**Installation drawing**

**3120 with blade terminals**



**3120 with push-in terminals**



**Terminal types**

**3120-F521-G7**



**3120-F551-G7**



**3120-F521-N7**



**3120-F551-N7**



**3120-F521-H7**



**3120-F551-H7**



**3120-F521-P7**



**3120-F551-P7**



1

Accessories

**Insulated cover**  
Y 303 068 01



**Terminal adapter**  
Y 303 862 01



**Blanking piece in -F3 frame**  
Y 303 885 31



**Rear terminal shroud black (IP64)**  
Y 304 275 01



**Water splash cover, transparent (IP66)**  
for mounting style -F2..  
X 221 619 01



**Mounting of**  
X221 619 01



All dimensions without tolerances are for reference only. E-T-A reserves the right change specifications at any time in the interest of improved design, performance and cost effectiveness, the right to make changes in these specifications without notice is reserved. Product markings may not be exactly as the ordering codes. Errors and omissions excepted.



**Accessories**

**Plug-in connector  
Y 31214001**

Connecting cables can be pre-wired. Two retaining clips ensure a tight fit.

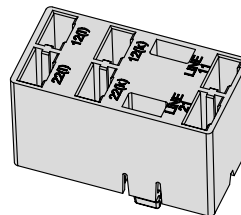
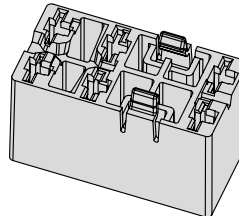
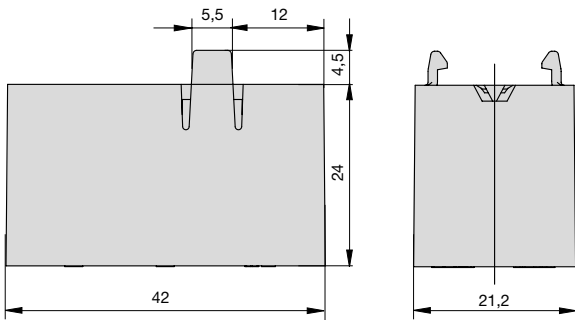
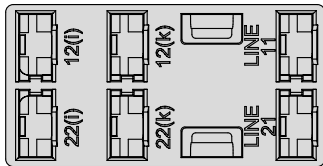

**Benefits:**

- Reduced installation time and costs for final assembly
- Quick replacement of devices

**Note:**

Delivery without receptacles.

Dimensions of receptacles (width 6.3 mm) are in accordance with DIN 46340 part 3, shape A.

Examples of suitable receptacles: Stocko RSB 7916 F6,3-1 / Klaucke type 2730 / Vogt type 3832d.67 / TE FASTON Terminals 250 Series / Delphi Packard 58 Series

Plug-in connector mounted on circuit breaker:

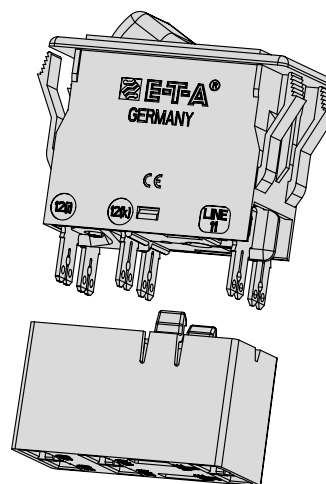
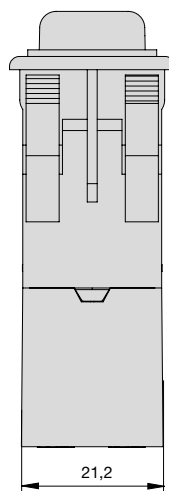
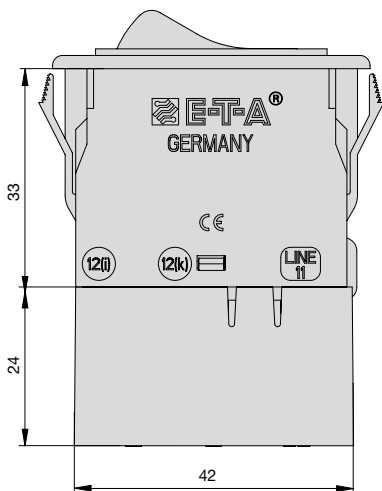

## Description - Appliance inlet module X3120-A/-B

The appliance inlet module X3120 with circuit breaker type 3120-F5/-F7/-F8 combines up to four functions within a single component: A C14/C20 appliance inlet, a rocker-actuated or push button switch and resettable overcurrent protection and a filter. Screw-type mounting from the front or from the rear.

## Typical applications

Electrical medical apparatus, laboratory equipment, professional audio equipment and office machines.

## Approvals

### X3120-A – C14 inlet

Authority	Standard	Voltage ratings	Max. current
ENEC	IEC/EN 60320-1	AC 240 V	10 A
UL/CSA	UL 498	AC 250 V	15 A
CQC	CCC	AC 250 V	10 A

### Approvals X3120-A – filter

Design corresponding to UL 1283, CSA 22.2 No. 8 1986, IEC/EN 60939

### X3120-B – C20 inlet

Authority	Standard	Voltage ratings	Max. current
ENEC	IEC/EN 60320-1	AC 240 V	16 A
UL/CSA	UL 498	AC 240 V	20 A

## Selection current rating of the filter

Current rating circuit breaker	Minimum current rating of the filter
0,1...1 A	1 A
1,2...3 A	3 A
3,5...6 A	6 A
7...8A	8 A
9...10 A	10 A
12 A	12 A
14...15 A	15 A

Circuit breaker type 3120 with thermal release protects the filter in case of overloads.

For the protection of the filter in the event of higher overcurrents we recommend circuit breaker type 3120 with thermal-magnetic release (3120...M1...).

Further technical information upon request.

All dimensions without tolerances are for reference only. In the interest of improved design, performance and cost effectiveness the right to make changes in these specifications without notice is reserved. Product markings may not be exactly as the ordering codes. Errors and omissions excepted.



## Order numbering code

### Type No.

**X3120** Appliance inlet module for circuit breaker type 3120

### Module

**A** appliance inlet C14 (with filter)

**B** appliance inlet C20 (without filter)

### Mounting

**04** screw-type mounting

### Filter

**00** without filter

**01** general performance IEC inlet filter

**03** general performance IEC inlet filter, medical version

**06** high performance IEC inlet filter, medical version

### Filter current rating

**00** without filter

**01** 1 A

**03** 3 A

**06** 6 A

**08** 8 A

**10** 10 A

**12** 12 A

**15** 15 A

### Version

**01** not wired; mounting position 3120:

OFF position to connector

**11** wired; mounting position 3120:

OFF position to connector

### Assembly status

**M** module supplied with circuit breaker 3120 and filter (module A) fitted

**X3120- B 04 00 00 01 M** ordering example

## Technical Data (type X3120-B, without filter)

Rated voltage	AC 240 V
Current rating (inlet)	16 A (IEC) 20 A (UL/CSA)
Ambient temperature	-25°C ...+60°C
Number of poles	L, N + earth
Protection class:	I
Mounting method:	screw-type mounting (front or rear)
Connection:	blade terminals DIN 46244 6.3 mm x 0.8 mm
Housing material:	thermoplastics, black UL94V-0
Appliance inlet:	C20 according to IEC/EN 60320-1, UL498
Mains switch:	Circuit breaker 3120-F5/-F7/-F8 (3120-F8 with push button actuation: technical data upon request)

## Technical Data (type X3120-A with filter)

Rated voltage	AC 250 V
Current rating (inlet)	10 A (IEC) 15 A (UL/CSA)
Current rating (filter)	1 A, 3 A, 6 A, 8 A, 10 A, 12 A, 15 A
Ambient temperature	-25°C ...+60°C
Number of poles	L, N + earth
Protection class:	I
Mounting method:	screw-type mounting (front or rear)
Connection:	blade terminals DIN 46244 6.3 mm x 0.8 mm
Housing material:	thermoplastics, black UL94V-0
Appliance inlet:	C14 according to IEC/EN 60320-1, UL498
Mains switch:	Circuit breaker 3120-F5/-F7/-F8 (3120-F8 with push button actuation: technical data upon request)

## Dimensions (type X3120-B)



## Dimensions (type X3120-A)



## Cut-out dimensions (type X3120-B)



## Cut-out dimensions (type X3120-A)



**Electrical schematics X3120-A**

**X3120-A0401**

General performance filter



**X3120-A0403 und X3120-A0406**

Medical version



**X3120-A0401 and X3120-A0403 - General performance filter**

Typical filter attenuation: Per CISPR 17

A = 50 Ω / 50 Ω sym; B = 50 Ω / 50 Ω asym; C = 0.1 Ω / 100 Ω sym; D = 100 Ω / 0.1 Ω sym

1 and 3 A types

6 to 10 A types

12 and 15 A types

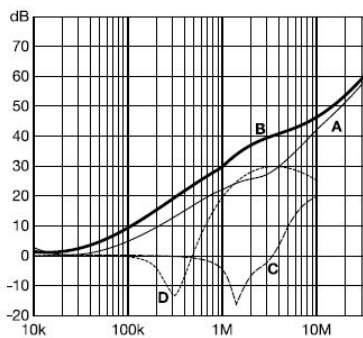

**X3120-A0406 - High performance filter**

Typical filter attenuation: Per CISPR 17

A = 50 Ω / 50 Ω sym; B = 50 Ω / 50 Ω asym; C = 0.1 Ω / 100 Ω sym; D = 100 Ω / 0.1 Ω sym

1 and 3 A types

6 to 10 A types

12 and 15 A types



**Filter selection table**

Filter	Rated current 50°C (25°C) A	Leakage current 250VAC/50 Hz µA	Inductance L mH	Capacitance Cx µF	Capacitance Cy nF	Resistance R kΩ
X3120-A040101..M	1 (1.2)	373	12	0.1	2.2	
X3120-A040103..M	3 (3.5)	373	2.5	0.1	2.2	
X3120-A040106..M	6 (7.2)	373	0.78	0.1	2.2	
X3120-A040108..M	8 (10.6)	373	0.5	0.1	2.2	
X3120-A040110..M	10 (11.6)	373	0.225	0.1	2.2	
X3120-A040112..M	12 (12)	373	0.11	0.1	2.2	
X3120-A040115..M	15 (15)	373	0.075	0.1	2.2	
X3120-A040301..M	1 (1.2)	2	12	0.1		1000
X3120-A040303..M	3 (3.5)	2	2.5	0.1		1000
X3120-A040306..M	6 (7.2)	2	0.78	0.1		1000
X3120-A040308..M	8 (10.6)	2	0.5	0.1		1000
X3120-A040310..M	10 (11.6)	2	0.225	0.1		1000
X3120-A040312..M	12 (12)	2	0.11	0.1		1000
X3120-A040315..M	15 (15)	2	0.075	0.1		1000
X3120-A040601..M	1 (1.2)	2	59.53	0.1		1000
X3120-A040603..M	3 (3.5)	2	13.45	0.1		1000
X3120-A040606..M	6 (7.2)	2	4.1	0.1		1000
X3120-A040608..M	8 (10.6)	2	2.3	0.1		1000
X3120-A040610..M	10 (11.6)	2	1.02	0.1		1000
X3120-A040612..M	12 (12)	2	0.58	0.1		1000
X3120-A040615..M	15 (15)	2	0.4	0.1		1000

## Description undervoltage release module X3120-U

Add-on module for circuit breaker type 3120. The undervoltage release module trips the 3120 circuit breaker/switch combination in the event of a voltage drop or power failure. When the voltage is restored, the 3120 must be reset to reconnect the load, thereby avoiding the safety hazards associated with automatic re-start of machinery.

**Note:** Basic unit 3120-...-H7 or -G7 requires screw terminals. Not possible in combination with PT terminals.

## Typical applications

All machines and devices where automatic re-start after restoration of power could be dangerous, e.g. drilling machines, electric saws, sausage slicers etc.

## Order numbering code

### Type No.

**X3120** module for type 3120

### Module

**U** undervoltage release module

### Design

**00** standard (without separate connections)

**01** 1 blade terminals 2.8x0.8

**02** 2 blade terminals 2.8x0.8

### Rated voltage

**00** AC 230/240 V 50/60 Hz

**01** AC 120 V 50/60 Hz

### Assembly status

**M** module mounted to circuit breaker 3120

**X3120-U 00 00 M** ordering example

## Dimensions



## Schematic diagrams



## Technical data

Voltage ratings	AC 100 V; 120 V; 230/240 V (50/60 Hz); DC 24 V
Voltage tolerances	+ 10 % / - 15 %
Typical life	20,000 cycles
Current consumption	approx. 2.5 mA
Release values	$0.2 \times U_N < U < 0.7 \times U_N$ (at a rated voltage of AC 100 V the device can trip at 70 V and must trip at 20 V)
Release delay	< 20 ms
Latch-in values	$\geq 85 \% U_N$
Ambient temperature	-30 ... 60 °C
Vibration	8 g (57-500 Hz), $\pm 0.61$ mm (10-57 Hz) test to IEC 60068-2-6, test Fc 10 frequency cycles/axis
Shock	30 g (11 ms) test to IEC 60068-2-27, test Ea
Corrosion	48 hours at 5 % salt mist, test to IEC 60068-2-11, test Ka
Humidity	240 hrs in 95 % RH test to IEC 60068-2-78, test Cab
Mass	approx. 53 g (including base unit)

All dimensions without tolerances are for reference only. E-T-A reserves the right change specifications at any time in the interest of improved design, performance and cost effectiveness, the right to make changes in these specifications without notice is reserved. Product markings may not be exactly as the ordering codes. Errors and omissions excepted.

## Description auxiliary contact module X3120-S

Add-on module for circuit breaker type 3120-F. The auxiliary contact module has a change-over contact as signal contact and is operated with actuation of the CBE. Not possible in combination with PT terminals.

## Typical applications

Status monitoring of CBE and/or the connected loads.

## Order numbering code

### Type No.

**X3120** module for types 3120 and 3140

### Module

**S** auxiliary contact module

### Contact configuration

**0** change-over contact

### Terminal design

**1** blade terminals 2.8 x 0.5 (QC .110), silver-plated

### Contact rating

AC voltage		DC voltage	
rated voltage	rated current	rated voltage	rated current
<b>A</b> 10 V - 250 V	0.1...4 A	12 V	0.1...4 A
		24 V	0.1...4 A
		60 V	0.1...1 A
		110 V	0.1...0.5 A
<b>B</b> 5 V - 250 V	5 ...100 mA	220 V	0.1...0.25 A
		5 V - 250 V	5...100 mA

### Assembly status

**M** module mounted to circuit breaker 3120

**X3120-S 0 1 A M** ordering example

\* without approval mark

## Dimensions



## Schematic diagram



## Technical data

Rated voltage	AC 250 V, DC 220 V
Current ratings	0.1...4 A / 5...100 mA
Typical life	50,000 cycles
Ambient temperature	-30...60 °C
<b>Dielectric strength</b>	
between main and auxiliary circuit	test voltage AC 3,000 V
Insulation resistance	> 100 MOhm (DC 500 V)
Vibration	6 g (57-500 Hz), ± 0.46 mm (10-57 Hz) test to IEC 60068-2-6, test Fc 10 frequency cycles/axis
Shock	15 g (11 ms) test to IEC 60068-2-27, test Ea
Corrosion	96 hours at 5 % salt mist, test to IEC 60068-2-11, test Ka
Humidity	240 hrs in 95 % RH test to IEC 60068-2-78, test Cab
Mass	approx. 38 g (including base unit)

All dimensions without tolerances are for reference only. E-T-A reserves the right change specifications at any time in the interest of improved design, performance and cost effectiveness, the right to make changes in these specifications without notice is reserved. Product markings may not be exactly as the ordering codes. Errors and omissions excepted.

## Description remote trip module X3120-M

A module which adds remote trip capability to all versions of type 3120-F. A voltage applied across the coil, by means of an external sensor for example, will cause disconnection of the main switch/circuit breaker mechanism.

Not possible in combination with PT terminals.

## Typical applications

Electrical remote trip of safety systems.

## Order numbering code

<b>Type No.</b>	<b>X3120</b> module for type 3120
<b>Module</b>	<b>M</b> magnetic relay trip module
<b>Style</b>	<b>2</b> magnetic remote trip coil
<b>Terminal design</b>	<b>P7</b> blade terminals DIN 46244-A6.3-0.8
<b>Assembly status</b>	<b>M</b> module mounted to circuit breaker 3120
<b>Rated voltage</b>	<b>AC 120, 230 V</b>
	<b>DC 12, 24 V</b>
<b>X3120- M 2 P7 M -12 V</b> ordering example	

## Standard voltage ratings and typical internal resistance values

voltage rating	internal internal resistance (Ω)	voltage rating	internal internal resistance (Ω)
DC 12 V	0.78	AC 120 V	71.0
DC 24 V	3.3	AC 230 V	312

## Dimensions



## Schematic diagram



## Technical data

Voltage ratings	AC 120...230 V; DC 12...24 V
Power consumption	approx. 200 Watt
Pulse operation	20 ms < t <sub>ON</sub> < 100 ms / t <sub>OFF</sub> > 10 sec
Trip time	< 20 ms
Typical life	50,000 operations at U <sub>N</sub>
Ambient temperature	-30...60 °C
<b>Dielectric strength</b>	
between main and trip current circuit	test voltage AC 3,000 V
Insulation resistance	> 100 MOhm (DC 500 V)
Vibration	8 g (57-500 Hz), ± 0.61 mm (10-57 Hz) test to IEC 60068-2-6, test Fc 10 frequency cycles/axis
Shock	30 g (11 ms) test to IEC 60068-2-27, test Ea
Corrosion	96 hours at 5 % salt mist, test to IEC 60068-2-11, test Ka
Humidity	240 hrs in 95 % RH test to IEC 60068-2-78, test Cab
Mass	approx. 53 g (including base unit)

All dimensions without tolerances are for reference only. E-T-A reserves the right change specifications at any time in the interest of improved design, performance and cost effectiveness, the right to make changes in these specifications without notice is reserved. Product markings may not be exactly as the ordering codes. Errors and omissions excepted.





Компания «ЭлектроПласт» предлагает заключение долгосрочных отношений при поставках импортных электронных компонентов на взаимовыгодных условиях!

Наши преимущества:

- Оперативные поставки широкого спектра электронных компонентов отечественного и импортного производства напрямую от производителей и с крупнейших мировых складов;
- Поставка более 17-ти миллионов наименований электронных компонентов;
- Поставка сложных, дефицитных, либо снятых с производства позиций;
- Оперативные сроки поставки под заказ (от 5 рабочих дней);
- Экспресс доставка в любую точку России;
- Техническая поддержка проекта, помощь в подборе аналогов, поставка прототипов;
- Система менеджмента качества сертифицирована по Международному стандарту ISO 9001;
- Лицензия ФСБ на осуществление работ с использованием сведений, составляющих государственную тайну;
- Поставка специализированных компонентов (Xilinx, Altera, Analog Devices, Intersil, Interpoint, Microsemi, Aeroflex, Peregrine, Syfer, Eurofarad, Texas Instrument, Miteq, Cobham, E2V, MA-COM, Hittite, Mini-Circuits, General Dynamics и др.);

Помимо этого, одним из направлений компании «ЭлектроПласт» является направление «Источники питания». Мы предлагаем Вам помощь Конструкторского отдела:

- Подбор оптимального решения, техническое обоснование при выборе компонента;
- Подбор аналогов;
- Консультации по применению компонента;
- Поставка образцов и прототипов;
- Техническая поддержка проекта;
- Защита от снятия компонента с производства.



#### Как с нами связаться

**Телефон:** 8 (812) 309 58 32 (многоканальный)

**Факс:** 8 (812) 320-02-42

**Электронная почта:** [org@eplast1.ru](mailto:org@eplast1.ru)

**Адрес:** 198099, г. Санкт-Петербург, ул. Калинина, дом 2, корпус 4, литера А.