

HDSP-076x Series

Hexadecimal and Numeric Displays for Industrial Applications

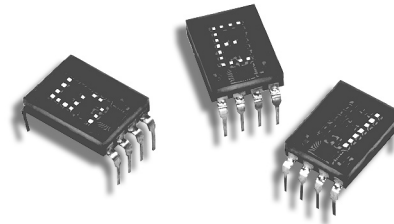

Data Sheet



**HDSP-076x Series, HDSP-077x Series
HDSP-086x Series, HDSP-096x Series**

Description

These solid state display devices are designed and tested for use in adverse industrial environments. The character height is 7.4 mm (0.29 inch). The numeric and hexadecimal devices incorporate an on-board IC that contains the data memory, decoder and display driver functions.

The numeric devices decode positive BCD logic into characters "0-9", a "-" sign, decimal point, and a test pattern. The hexadecimal devices decode positive BCD logic into 16 characters, "0-9, A-F." An input is provided on the hexadecimal devices to blank the display (all LEDs off) without losing the contents of the memory.

The over range device displays "±1" and right hand decimal point and is typically driven via external switching transistors.

Features

- Three colors: High-efficiency red
Yellow
High performance green
- Two high-efficiency red options
 - Low power
 - High brightness
- Three character options
 - Numeric
 - Hexadecimal
 - Over range
- Performance guaranteed over temperature
- Memory latch/decoder/driver: TTL compatible
- 4 x 7 dot matrix character
- Categorized for luminous intensity
- Yellow and green categorized for color

Device Selection Guide

Part Number	Color	Description	Front View
0760	High-Efficiency	Numeric, Right Hand DP	A
0761	Red	Numeric, Left Hand DP	B
0762	Low Power	Hexadecimal	C
0763		Over Range ±1	D
0770	High-Efficiency	Numeric, Right Hand DP	A
0771	Red	Numeric, Left Hand DP	B
0772	High Brightness	Hexadecimal	C
0860	Yellow	Numeric, Right Hand DP	A
0861		Numeric, Left Hand DP	B
0862		Hexadecimal	C
0863		Over Range ±1	D
0960	Green	Numeric, Right Hand DP	A
0961		Numeric, Left Hand DP	B
0962		Hexadecimal	C
0963		Over Range ±1	D

Typical Applications

- Industrial equipment
- Computer peripherals
- Instrumentation
- Telecommunication equipment

Package Dimensions

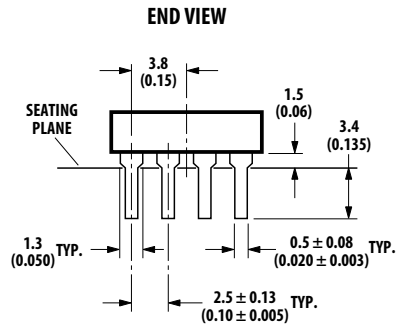
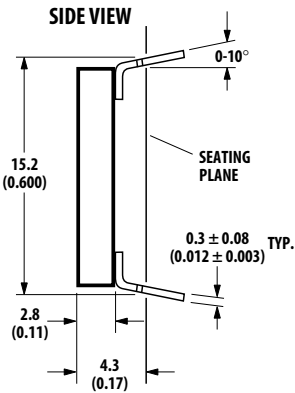
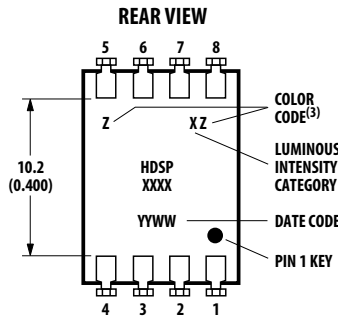
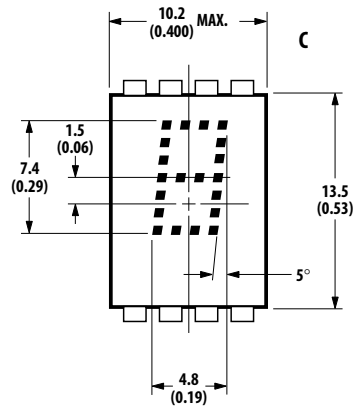
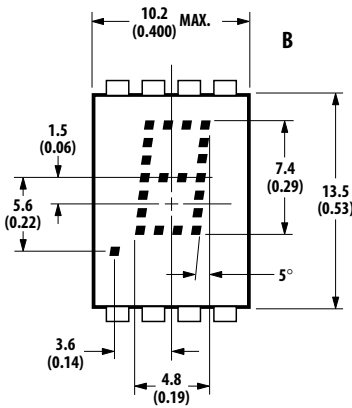
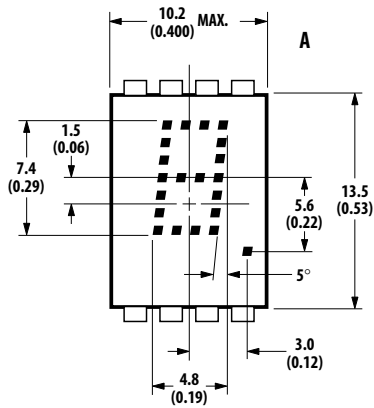

PIN	FUNCTION	
	NUMERIC	HEXADECIMAL
1	Input 2	Input 2
2	Input 4	Input 4
3	Input 8	Input 8
4	Decimal Point	Blanking Control
5	Latch Enable	Latch Enable
6	Ground	Ground
7	V _{CC}	V _{CC}
8	Input 1	Input 1

NOTES:

1. DIMENSIONS IN MILLIMETERS AND (INCHES).
2. DIGIT CENTER LINE IS ± 0.38 mm (± 0.015 INCH) FROM PACKAGE CENTER LINE.
3. UNLESS OTHERWISE SPECIFIED, THE TOLERANCE ON ALL DIMENSIONS IS ± 0.38 mm (± 0.015 INCH).
4. HDSP-0860 AND HDSP-0960 SERIES.

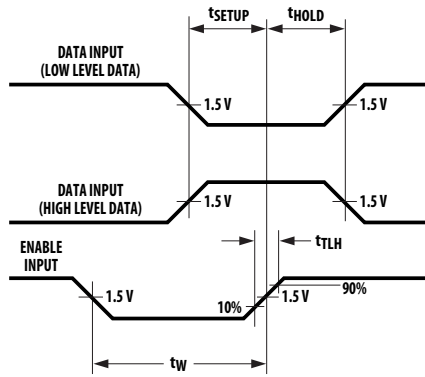

Figure 1. Timing diagram.



Figure 2. Logic block diagram.

TRUTH TABLE					
BCD DATA ^[1]				NUMERIC	HEXADECIMAL
X ₈	X ₄	X ₂	X ₁		
L	L	L	L	0	0
L	L	L	H	1	1
L	L	H	L	2	2
L	L	H	H	3	3
L	H	L	L	4	4
L	H	L	H	5	5
L	H	H	L	6	6
L	H	H	H	7	7
H	L	L	L	8	8
H	L	L	H	9	9
H	L	H	L	A	A
H	L	H	H	(BLANK)	B
H	H	L	L	(BLANK)	C
H	H	L	H	...	D
H	H	H	L	(BLANK)	E
H	H	H	H	(BLANK)	F
DECIMAL PT. ^[2]				ON	V _{DP} = L
				OFF	V _{DP} = H
ENABLE ^[1]				LOAD DATA	V _E = L
				LATCH DATA	V _E = H
BLANKING ^[3]				DISPLAY-ON	V _B = L
				DISPLAY-OFF	V _B = H

NOTES:

1. H = LOGIC HIGH; L = LOGIC LOW. WITH THE ENABLE INPUT AT LOGIC HIGH, CHANGES IN BCD INPUT LOGIC LEVELS HAVE NO EFFECT UPON DISPLAY MEMORY, DISPLAYED CHARACTER, OR DP.
2. THE DECIMAL POINT INPUT, DP, PERTAINS ONLY TO THE NUMERIC DISPLAYS.
3. THE BLANKING CONTROL INPUT, B, PERTAINS ONLY TO THE HEXADECIMAL DISPLAYS. BLANKING INPUT HAS NO EFFECT UPON DISPLAY MEMORY.

Absolute Maximum Ratings

Description	Symbol	Min.	Max.	Unit
Storage Temperature, Ambient	T_S	-65	+100	°C
Operating Temperature, Ambient ^[1]	T_A	-55	+85	°C
Supply Voltage ^[2]	V_{CC}	-0.5	+7.0	V
Voltage Applied to Input Logic, dp and Enable Pins	V_I, V_{DP}, V_E	-0.5	V_{CC}	V
Voltage Applied to Blanking Input ^[2]	V_B	-0.5	V_{CC}	V
Soldering Temperature [1.59 mm (0.063 inch) Below Body]				
Solder Dipping, max. 5 Seconds			260	°C
Wave Soldering, max. 3 Seconds			250	°C

Recommended Operating Conditions

Description	Symbol	Min.	Nom.	Max.	Unit
Supply Voltage ^[2]	V_{CC}	4.5	5.0	5.5	V
Operating Temperature, Ambient ^[1]	T_A	-55		+85	°C
Enable Pulse Width	t_W	100			nsec
Time Data Must Be Held Before Positive Transition of Enable Line	t_{SETUP}	50			nsec
Time Data Must Be Held After Positive Transition of Enable Line	t_{HOLD}	50			nsec
Enable Pulse Rise Time	t_{TLH}			1.0	msec

Optical Characteristics at $T_A = 25^\circ\text{C}$, $V_{CC} = 5.0\text{ V}$

Device	Description	Symbol	Min.	Typ.	Max.	Unit
HDSP-0760 Series	Luminous Intensity per LED (Digit Average) ^[3,4]	I_V	65	140		μcd
	Peak Wavelength	λ_{PEAK}		635		nm
	Dominant Wavelength ^[5]	λ_d		626		nm
HDSP-0770 Series	Luminous Intensity per LED (Digit Average) ^[3,4]	I_V	260	620		μcd
	Peak Wavelength	λ_{PEAK}		635		nm
	Dominant Wavelength ^[5]	λ_d		626		nm
HDSP-0860 Series	Luminous Intensity per LED (Digit Average) ^[3,4]	I_V	215	490		μcd
	Peak Wavelength	λ_{PEAK}		583		nm
	Dominant Wavelength ^[5,6]	λ_d		585		nm
HDSP-0960 Series	Luminous Intensity per LED (Digit Average) ^[3,4]	I_V	298	1100		μcd
	Peak Wavelength	λ_{PEAK}		568		nm
	Dominant Wavelength ^[5,6]	λ_d		574		nm

Notes:

1. The nominal thermal resistance of a display mounted in a socket that is soldered onto a printed circuit board is $R_{\theta JA} = 50^\circ\text{C/W/device}$. The device package thermal resistance is $R_{\theta J-PIN} = 15^\circ\text{C/W/device}$. The thermal resistance device pin-to-ambient through the PC board should not exceed $35^\circ\text{C/W/device}$ for operation at $T_A = +85^\circ\text{C}$.
2. Voltage values are with respect to device ground, pin 6.
3. These displays are categorized for luminous intensity with the intensity category designated by a letter code located on the back of the display package. Case temperature of the device immediately prior to the light measurement is equal to 25°C .

Electrical Characteristics; $T_A = -55^\circ\text{C}$ to $+85^\circ\text{C}$

Description	Symbol	Test Conditions	Min.	Typ. ^[7]	Max.	Unit	
Supply Current HDSP-0760 Series	I _{CC}	V _{CC} = 5.5 V (Characters "5." or "B" Displayed)		78	105	mA	
HDSP-0770 Series HDSP-0860 Series HDSP-0960 Series				120	175		
Power Dissipation HDSP-0760 Series			P _T		390	573	mW
HDSP-0770 Series HDSP-0860 Series HDSP-0960 Series					690	963	
Logic, Enable and Blanking Low-Level Input Voltage	V _{IL}	V _{CC} = 4.5 V			0.8	V	
Logic, Enable and Blanking High-Level Input Voltage	V _{IH}		2.0			V	
Logic and Enable Low-Level Input Current	I _{IL}	V _{CC} = 5.5 V			-1.6	mA	
Blanking Low-Level Input Current	I _{BL}	V _{IL} = 0.4 V			-10	μA	
Logic, Enable and Blanking High-Level Input Current	I _{IH}	V _{CC} = 5.5 V V _{IH} = 2.4 V			+40	μA	
Weight				1.0		gm	
Leak Rate					5x10 ⁻⁸	cc/sec	

Notes:

4. The luminous intensity at a specific operating ambient temperature, I_V (T_A) may be approximated from the following exponential equation:

$$I_V(T_A) = I_V(25^\circ\text{C}) e^{[k(T_A - 25^\circ\text{C})]}$$

Device	K
HDSP-0760 Series HDSP-0770 Series	-0.0131/°C
HDSP-0860 Series	-0.0112/°C
HDSP-0960 Series	-0.0104/°C

5. The dominant wavelength, λ_d, is derived from the CIE Chromaticity Diagram and is that single wavelength which defines the color of the device.

6. The HDSP-0860 and HDSP-0960 series devices are categorized as to dominant wavelength with the category designated by a number on the back of the display package.

7. All typical values at V_{CC} = 5.0 V and T_A = 25°C.

Operational Considerations

Electrical

These devices use a modified 4x7 dot matrix light emitting diode to display decimal/hexadecimal numeric information. The high efficiency red and yellow LEDs are GaAsP epitaxial layer on a GaP transparent substrate. The green LEDs are GaP epitaxial layer on a GaP transparent substrate. The LEDs are driven by constant current drivers, BCD information is accepted by the display memory when the enable line is at logic low and the data is latched when the enable is at logic high. Using the enable pulse width and data setup and hold times listed in the Recommended Operating Conditions allows data to be clocked into an array of displays at a 6.7 MHz rate.

The decimal point input is active low true and this data is latched into the display memory in the same fashion as the BCD data. The decimal point LED is driven by the on-board IC.

The blanking control input on the hexadecimal displays blanks (turns off) the displayed information without disturbing the contents of display memory. The display is blanked at a minimum threshold level of 2.0 volts. When blanked, the display standby power is nominally 250 mW at $T_A = 25^\circ\text{C}$.

Mechanical

The primary thermal path for power dissipation is through the device leads. Therefore, to insure reliable operation up to an ambient temperature of $+85^\circ\text{C}$, it is important to maintain a case-to-ambient thermal resistance of less than $35^\circ\text{C watt/device}$ as measured on top of display pin 3.

For information on soldering and post solder cleaning see Application Note 1027, *Soldering LED Components*.

Contrast Enhancement

These display devices are designed to provide an optimum ON/OFF contrast when placed behind an appropriate contrast enhancement filter. For further information, please refer to Application Note 1015, *Contrast Enhancement Techniques for LED Displays*.

Over Range Display

The over range devices display “±1” and decimal point. The character height and package configuration are the same as the numeric and hexadecimal devices. Character selection is obtained via external switching transistors and current limiting resistors.

Package Dimensions

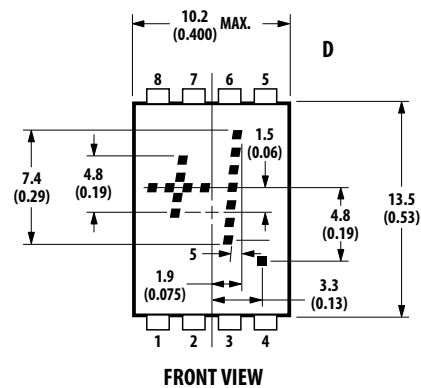

PIN	FUNCTION
1	Plus
2	Numeral One
3	Numeral One
4	DP
5	Open
6	Open
7	V _{CC}
8	Minus/Plus

Character	Pin			
	1	2,3	4	8
+	1	X	X	1
-	0	X	X	1
1	X	1	X	X
Decimal Point	X	X	1	X
Blank	0	0	0	0

Notes:

0: Line switching transistor in Figure 7 cutoff.

1: Line switching transistor in Figure 7 saturated.

X: 'don't care'

NOTE: DIMENSIONS IN MILLIMETERS AND (INCHES).

Absolute Maximum Ratings

Description	Symbol	Min.	Max.	Unit
Storage Temperature, Ambient	T_S	-65	+100	°C
Operating Temperature, Ambient	T_A	-55	+85	°C
Forward Current, Each LED	I_F		10	mA
Reverse Voltage, Each LED	V_R		5	V

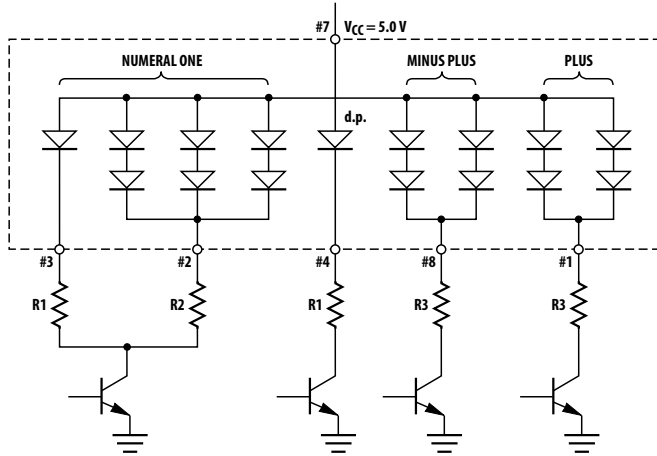

Figure 3. Typical driving circuit.

Recommended Operating Conditions $V_{CC} = 5.0\text{ V}$

	Forward Current Per Device LED, mA	Resistor Value		
		R_1	R_2	R_3
HDSP-0763				
Low Power	2.8	1300	200	300
High Brightness	8	360	47	68
HDSP-0863	8	360	36	56
HDSP-0963	8	360	30	43

Luminous Intensity per LED

(Digit Average)^[3,4] at $T_A = 25^\circ\text{C}$

Device	Test Conditions	Min.	Typ.	Units
HDSP-0763	$I_F = 2.8\text{ mA}$	65	140	μcd
	$I_F = 8\text{ mA}$		620	μcd
HDSP-0863	$I_F = 8\text{ mA}$	215	490	μcd
HDSP-0963	$I_F = 8\text{ mA}$	298	1100	μcd

Electrical Characteristics: T_A = -55°C to +85°C

Device	Description	Symbol	Test Conditions	Min.	Typ.	Max.	Unit
HDSP-0763	Power Dissipation (All LEDs Illuminated)	P _T	I _F = 2.8 mA		72		mW
			I _F = 8 mA		224	282	
	Forward Voltage per LED	V _F	I _F = 2.8 mA		1.6		V
			I _F = 8 mA		1.75	2.2	
HDSP-0863	Power Dissipation (All LEDs Illuminated)	P _T	I _F = 8 mA		237	282	mW
	Forward Voltage per LED	V _F			1.90	2.2	V
HDSP-0963	Power Dissipation (All LEDs Illuminated)	P _T	I _F = 8 mA		243	282	mW
	Forward Voltage per LED	V _F			1.85	2.2	V

Intensity Bin Limits for HDSP-0760 Series

Bin	Intensity Range (μcd)	
	Min.	Max.
A	65.00	102.14
B	84.29	137.86
C	114.29	200.00
D	165.71	300.00
E	260.00	487.86
F	402.86	755.71
G	625.00	1171.43

Note:

Test conditions as specified in Optical Characteristic table.

Intensity Bin Limits for HDSP-0860 Series

Bin	Intensity Range (μcd)	
	Min.	Max.
A	215.00	337.86
B	279.29	456.43
C	377.14	662.14
D	547.14	992.86
E	820.71	1539.29
F	1272.14	2385.71

Note:

Test conditions as specified in Optical Characteristic table.

Color Bin Limits

Color	Bin	Color Range (nm)	
		Min.	Max.
Yellow	1	581.5	585.0
	2	584.0	587.5
	3	586.5	590.0
Green	1	570.0	574.0
	2	573.0	577.0
	3	576.0	580.0

Note:

Test conditions as specified in Optical Characteristic table.

Intensity Bin Limits for HDSP-0770 Series

Bin	Intensity Range (μcd)	
	Min.	Max.
E	260.00	487.64
F	403.00	755.79
G	624.64	1171.50
H	969.00	1817.00

Note:

Test conditions as specified in Optical Characteristic table.

Intensity Bin Limits for HDSP-0960 Series

Bin	Intensity Range (μcd)	
	Min.	Max.
C	298.57	523.57
D	432.86	785.00
E	648.57	1175.00
F	971.43	1757.86
G	1452.86	2629.29

Note:

Test conditions as specified in Optical Characteristic table.

For product information and a complete list of distributors, please go to our website: www.avagotech.com



Компания «ЭлектроПласт» предлагает заключение долгосрочных отношений при поставках импортных электронных компонентов на взаимовыгодных условиях!

Наши преимущества:

- Оперативные поставки широкого спектра электронных компонентов отечественного и импортного производства напрямую от производителей и с крупнейших мировых складов;
- Поставка более 17-ти миллионов наименований электронных компонентов;
- Поставка сложных, дефицитных, либо снятых с производства позиций;
- Оперативные сроки поставки под заказ (от 5 рабочих дней);
- Экспресс доставка в любую точку России;
- Техническая поддержка проекта, помощь в подборе аналогов, поставка прототипов;
- Система менеджмента качества сертифицирована по Международному стандарту ISO 9001;
- Лицензия ФСБ на осуществление работ с использованием сведений, составляющих государственную тайну;
- Поставка специализированных компонентов (Xilinx, Altera, Analog Devices, Intersil, Interpoint, Microsemi, Aeroflex, Peregrine, Syfer, Eurofarad, Texas Instrument, Miteq, Cobham, E2V, MA-COM, Hittite, Mini-Circuits, General Dynamics и др.);

Помимо этого, одним из направлений компании «ЭлектроПласт» является направление «Источники питания». Мы предлагаем Вам помощь Конструкторского отдела:

- Подбор оптимального решения, техническое обоснование при выборе компонента;
- Подбор аналогов;
- Консультации по применению компонента;
- Поставка образцов и прототипов;
- Техническая поддержка проекта;
- Защита от снятия компонента с производства.



Как с нами связаться

Телефон: 8 (812) 309 58 32 (многоканальный)

Факс: 8 (812) 320-02-42

Электронная почта: org@eplast1.ru

Адрес: 198099, г. Санкт-Петербург, ул. Калинина, дом 2, корпус 4, литера А.