

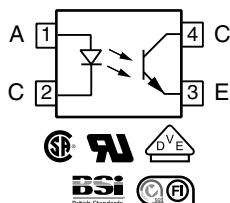

# Optocoupler, Phototransistor Output, Low Input Current

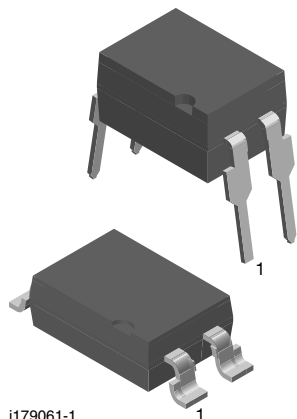

## FEATURES

- Good CTR linearity depending on forward current
- Low CTR degradation
- High collector emitter voltage,  $V_{CEO} = 55\text{ V}$
- Isolation test voltage,  $5300\text{ V}_{RMS}$
- Low coupling capacitance
- End stackable, 0.100" (2.54 mm) spacing
- High common mode transient immunity
- Material categorization: For definitions of compliance please see [www.vishay.com/doc?99912](http://www.vishay.com/doc?99912)



RoHS COMPLIANT

## APPLICATIONS

- Telecom
- Industrial controls
- Battery powered equipment
- Office machines

## AGENCY APPROVALS

- UL1577, file no. E52744 system code H or J, double protection
- CSA 93751
- DIN EN 60747-5-5 (VDE 0884-5) available with option 1
- BSI IEC 60950; IEC 60065
- FIMKO

## DESCRIPTION

The SFH618A (DIP) and SFH6186 (SMD) feature a high current transfer ratio, low coupling capacitance and high isolation voltage. These couplers have a GaAs infrared diode emitter, which is optically coupled to silicon planar phototransistor detector, and is incorporated in a plastic DIP-4 or SMD package.

The coupling devices are designed for signal transmission between two electrically separated circuits. The couplers are end-stackable with 2.54 mm lead spacing. Creepage and clearance distances of > 8 mm achieved with option 6.

## ORDERING INFORMATION

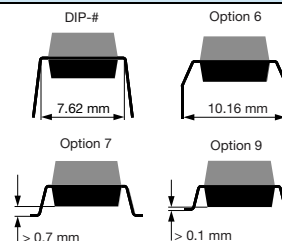
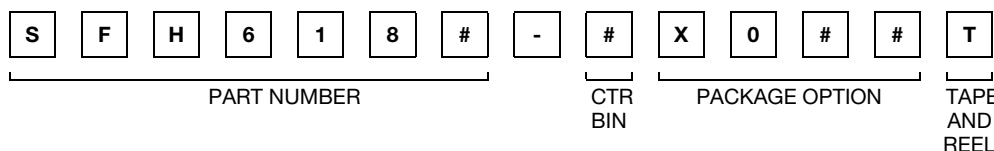

AGENCY CERTIFIED/PACKAGE	CTR (%)			
	1 mA			
<b>UL, CUL</b>	<b>63 to 125</b>	<b>100 to 200</b>	<b>160 to 320</b>	<b>250 to 500</b>
DIP-4	SFH618A-2	SFH618A-3	SFH618A-4	SFH618A-5
DIP-4, 400 mil, option 6	-	SFH618A-3X006	-	-
SMD-4, option 7	-	-	-	SFH618A-5X007T <sup>(1)</sup>
SMD-4, option 9	SFH6186-2T <sup>(1)</sup>	SFH6186-3T <sup>(1)</sup> , SFH6186-3T1 <sup>(2)</sup> , SFH6186-3X002T <sup>(1)</sup>	SFH6186-4T <sup>(1)</sup>	SFH6186-5T <sup>(1)</sup> , SFH6186-5T1 <sup>(2)</sup>
<b>VDE, UL, CUL</b>	<b>63 to 125</b>	<b>100 to 200</b>	<b>160 to 320</b>	<b>250 to 500</b>
DIP-4	-	SFH618A-3X001	SFH618A-4X001	-
DIP-4, 400 mil, option 6	-	SFH618A-3X016	SFH618A-4X016	SFH618A-5X016
SMD-4, option 7	-	SFH618A-3X017T <sup>(1)</sup>	-	SFH618A-5X017T <sup>(1)</sup>
SMD-4, option 9	-	SFH6186-3X001T <sup>(1)</sup>	SFH6186-4X001T	SFH6186-5X001T <sup>(1)</sup>

## Notes

- Additional options may be possible, please contact sales office
- <sup>(1)</sup> Also available in tubes, do not put T to the end
- <sup>(2)</sup> Product is rotated 180° in tape and reel cavity



ABSOLUTE MAXIMUM RATINGS (T <sub>amb</sub> = 25 °C, unless otherwise specified)				
PARAMETER	TEST CONDITION	SYMBOL	VALUE	UNIT
<b>INPUT</b>				
Reverse voltage		V <sub>R</sub>	6	V
Power dissipation		P <sub>diss</sub>	70	mW
Forward current		I <sub>F</sub>	60	mA
<b>OUTPUT</b>				
Collector emitter voltage		V <sub>CEO</sub>	55	V
Emitter collector voltage		V <sub>ECO</sub>	7	V
Collector current		I <sub>C</sub>	50	mA
	t <sub>p</sub> ≤ 1 ms	I <sub>C</sub>	100	mA
Power dissipation		P <sub>diss</sub>	150	mW
<b>COUPLER</b>				
Isolation test voltage between emitter and detector	t = 1 s	V <sub>ISO</sub>	5300	V <sub>RMS</sub>
Isolation resistance	V <sub>IO</sub> = 500 V, T <sub>amb</sub> = 25 °C	R <sub>IO</sub>	≥ 10 <sup>12</sup>	Ω
	V <sub>IO</sub> = 500 V, T <sub>amb</sub> = 100 °C	R <sub>IO</sub>	≥ 10 <sup>11</sup>	Ω
Storage temperature range		T <sub>stg</sub>	- 55 to + 150	°C
Ambient temperature range		T <sub>amb</sub>	- 55 to + 100	°C
Junction temperature		T <sub>j</sub>	125	°C
Soldering temperature <sup>(1)</sup>	max. 10 s, dip soldering distance to seating plane ≥ 1.5 mm	T <sub>slid</sub>	260	°C

**Notes**

- Stresses in excess of the absolute maximum ratings can cause permanent damage to the device. Functional operation of the device is not implied at these or any other conditions in excess of those given in the operational sections of this document. Exposure to absolute maximum ratings for extended periods of the time can adversely affect reliability.

<sup>(1)</sup> Refer to reflow profile for soldering conditions for surface mounted devices (SMD). Refer to wave profile for soldering conditions for through hole devices (DIP).

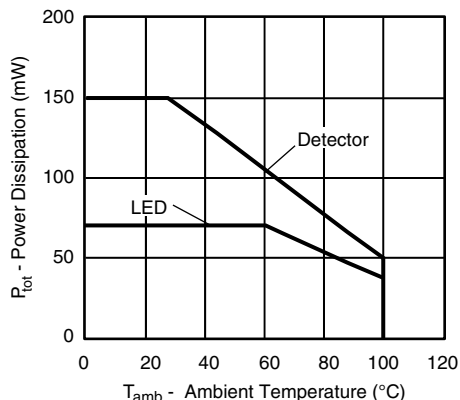

Fig. 1 - Permissible Power Dissipation vs. Ambient Temperature



ELECTRICAL CHARACTERISTICS (T <sub>amb</sub> = 25 °C, unless otherwise specified)								
PARAMETER	TEST CONDITION	PART	SYMBOL	MIN.	TYP.	MAX.	UNIT	
<b>INPUT</b>								
Forward voltage	I <sub>F</sub> = 5 mA		V <sub>F</sub>		1.1	1.5	V	
Reverse current	V <sub>R</sub> = 6 V		I <sub>R</sub>		0.01	10	μA	
Capacitance	V <sub>R</sub> = 0 V, f = 1 MHz		C <sub>O</sub>		25		pF	
Thermal resistance			R <sub>thja</sub>		1070		K/W	
<b>OUTPUT</b>								
Collector emitter leakage current	V <sub>CE</sub> = 10 V		I <sub>CEO</sub>		10	200	nA	
Collector emitter capacitance	V <sub>CE</sub> = 5 V, f = 1 MHz		C <sub>CE</sub>		7		pF	
Thermal resistance			R <sub>thja</sub>		500		K/W	
<b>COUPLER</b>								
Collector emitter saturation voltage	I <sub>C</sub> = 0.32 mA, I <sub>F</sub> = 1 mA	SFH618A-2	V <sub>CEsat</sub>		0.25	0.4	V	
		SFH6186-2	V <sub>CEsat</sub>		0.25	0.4	V	
	I <sub>C</sub> = 0.5 mA, I <sub>F</sub> = 1 mA	SFH618A-3	V <sub>CEsat</sub>		0.25	0.4	V	
		SFH6186-3	V <sub>CEsat</sub>		0.25	0.4	V	
	I <sub>C</sub> = 0.8 mA, I <sub>F</sub> = 1 mA	SFH618A-4	V <sub>CEsat</sub>		0.25	0.4	V	
		SFH6186-4	V <sub>CEsat</sub>		0.25	0.4	V	
	I <sub>C</sub> = 1.25 mA, I <sub>F</sub> = 1 mA	SFH618A-5	V <sub>CEsat</sub>		0.25	0.4	V	
		SFH6186-5	V <sub>CEsat</sub>		0.25	0.4	V	
	Coupling capacitance			C <sub>C</sub>		0.25		pF

**Note**

- Minimum and maximum values are testing requirements. Typical values are characteristics of the device and are the result of engineering evaluation. Typical values are for information only and are not part of the testing requirements.

CURRENT TRANSFER RATIO (T <sub>amb</sub> = 25 °C, unless otherwise specified)							
PARAMETER	TEST CONDITION	PART	SYMBOL	MIN.	TYP.	MAX.	UNIT
I <sub>C</sub> /I <sub>F</sub>	I <sub>F</sub> = 1 mA, V <sub>CE</sub> = 0.5 V	SFH618A-2	CTR	63		125	%
		SFH6186-2	CTR	63		125	%
	I <sub>F</sub> = 0.5 mA, V <sub>CE</sub> = 1.5 V	SFH618A-2	CTR	32	75		%
		SFH6186-2	CTR	32	75		%
	I <sub>F</sub> = 1 mA, V <sub>CE</sub> = 0.5 V	SFH618A-3	CTR	100		200	%
		SFH6186-3	CTR	100		200	%
	I <sub>F</sub> = 0.5 mA, V <sub>CE</sub> = 1.5 V	SFH618A-3	CTR	50	120		%
		SFH6186-3	CTR	50	120		%
	I <sub>F</sub> = 1 mA, V <sub>CE</sub> = 0.5 V	SFH618A-4	CTR	160		320	%
		SFH6186-4	CTR	160		320	%
	I <sub>F</sub> = 0.5 mA, V <sub>CE</sub> = 1.5 V	SFH618A-4	CTR	80	200		%
		SFH6186-4	CTR	80	200		%
	I <sub>F</sub> = 1 mA, V <sub>CE</sub> = 0.5 V	SFH618A-5	CTR	250		500	%
		SFH6186-5	CTR	250		500	%
	I <sub>F</sub> = 0.5 mA, V <sub>CE</sub> = 1.5 V	SFH618A-5	CTR	125	300		%
		SFH6186-5	CTR	125	300		%

SWITCHING CHARACTERISTICS (T <sub>amb</sub> = 25 °C, unless otherwise specified)							
PARAMETER	TEST CONDITION	SYMBOL	MIN.	TYP.	MAX.	UNIT	
Turn on time	V <sub>CC</sub> = 5 V, I <sub>C</sub> = 2 mA, R <sub>L</sub> = 100 Ω	t <sub>on</sub>		6		μs	
Rise time	V <sub>CC</sub> = 5 V, I <sub>C</sub> = 2 mA, R <sub>L</sub> = 100 Ω	t <sub>r</sub>		3.5		μs	
Turn off time	V <sub>CC</sub> = 5 V, I <sub>C</sub> = 2 mA, R <sub>L</sub> = 100 Ω	t <sub>off</sub>		5.5		μs	
Fall time	V <sub>CC</sub> = 5 V, I <sub>C</sub> = 2 mA, R <sub>L</sub> = 100 Ω	t <sub>f</sub>		5		μs	

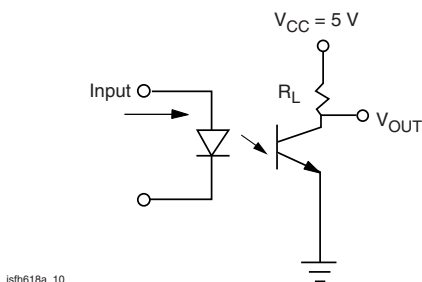

Fig. 2 - Test Circuit

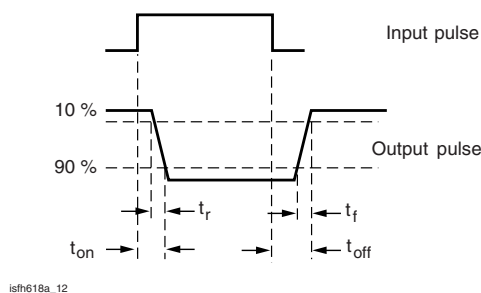

Fig. 3 - Test Circuit and Waveforms

SAFETY AND INSULATION RATINGS						
PARAMETER	TEST CONDITION	SYMBOL	MIN.	TYP.	MAX.	UNIT
Climatic classification (according to IEC68 part 1)				55/100/21		
Comparative tracking index		CTI	175		399	
$V_{IOTM}$			10000			V
$V_{IORM}$			890			V
$P_{SO}$					400	mW
$I_{SI}$					275	mA
$T_{SI}$					175	°C
Creepage distance	Standard DIP-4		7			mm
Clearance distance	Standard DIP-4		7			mm
Creepage distance	400 mil DIP-4		8			mm
Clearance distance	400 mil DIP-4		8			mm
Insulation thickness, reinforced rated	per IEC60950 2.10.5.1		0.4			mm

**Note**

- As per IEC60747-5-5, § 7.4.3.8.2, this optocoupler is suitable for “safe electrical insulation” only within the safety ratings. Compliance with the safety ratings shall be ensured by means of protective circuits.

**TYPICAL CHARACTERISTICS** ( $T_{amb} = 25\text{ }^{\circ}\text{C}$ , unless otherwise specified)

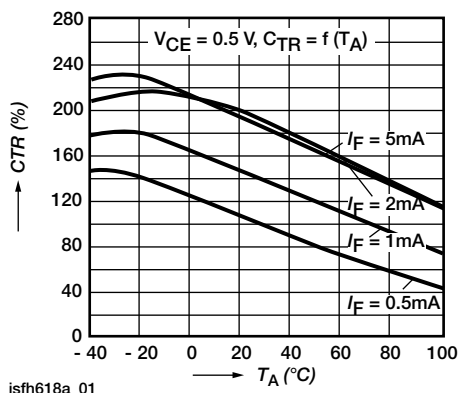

Fig. 4 - Current Transfer Ratio (typ.)

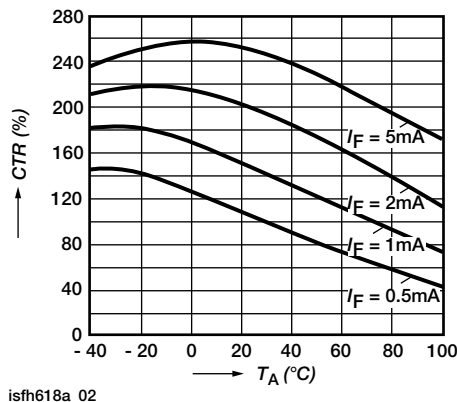

Fig. 5 - Current Transfer Ratio (typ.)

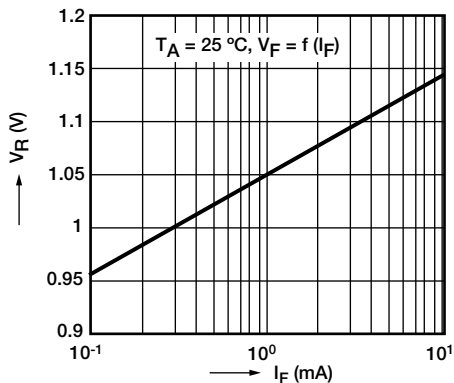

Fig. 6 - Diode Forward Voltage (typ.)

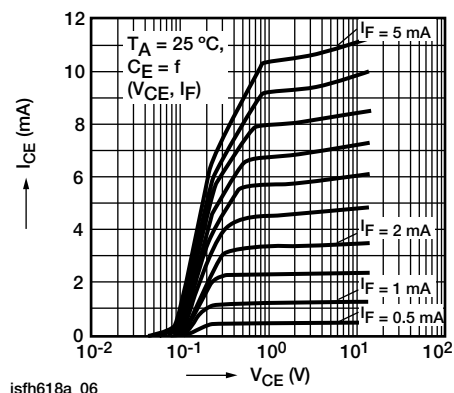

Fig. 9 - Output Characteristics

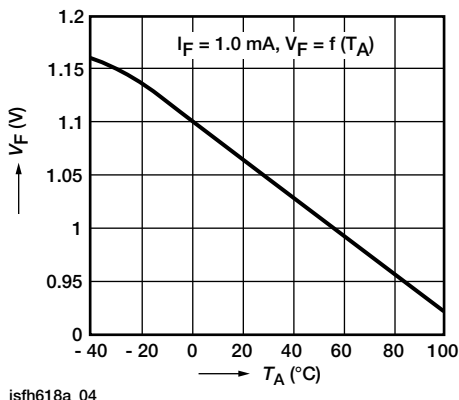

Fig. 7 - Diode Forward Voltage (typ.)

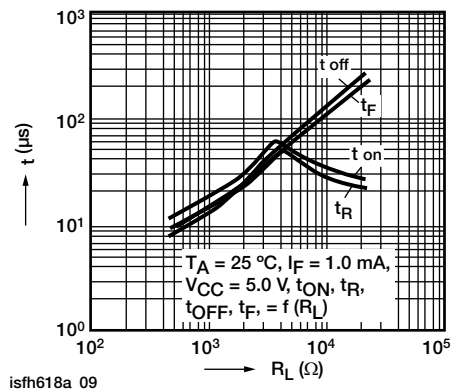

Fig. 10 - Switching Times (typ.)

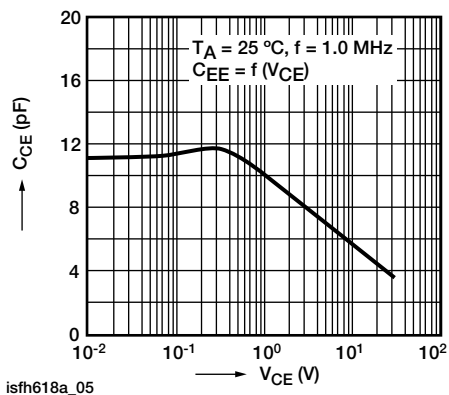
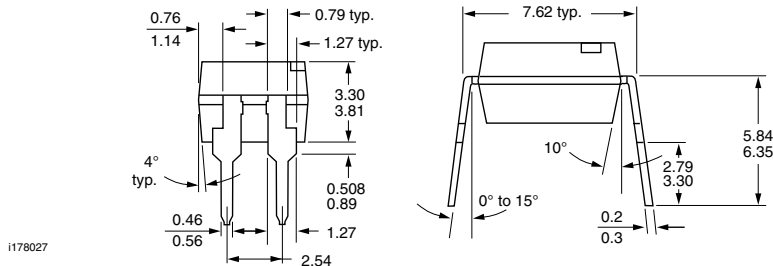
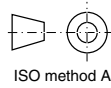
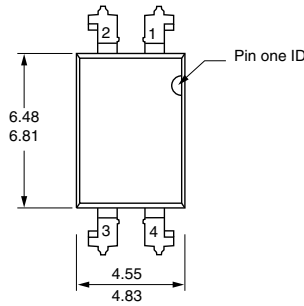

Fig. 8 - Transistor Capacitance



PACKAGE DIMENSIONS in millimeters



i178027

SMD

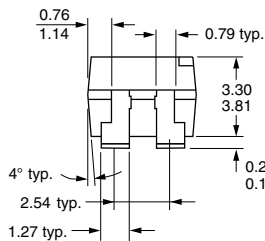
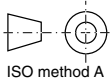
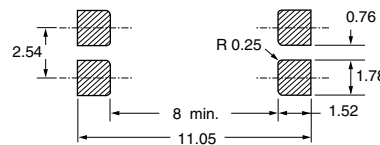
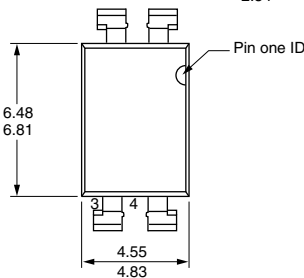

i178029

Lead coplanarity 0.004 max.

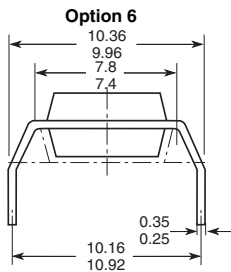
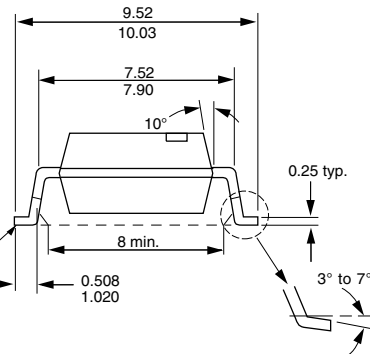

18450-11

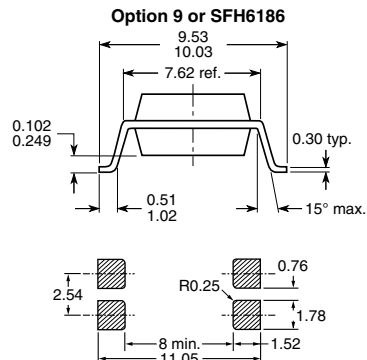
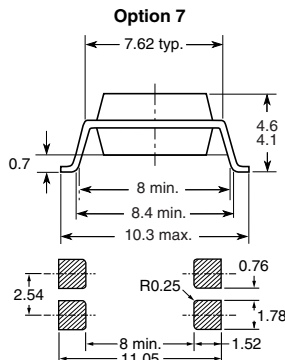

PACKAGE MARKING

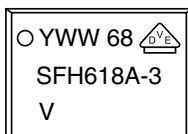



## Disclaimer

ALL PRODUCT, PRODUCT SPECIFICATIONS AND DATA ARE SUBJECT TO CHANGE WITHOUT NOTICE TO IMPROVE RELIABILITY, FUNCTION OR DESIGN OR OTHERWISE.

Vishay Intertechnology, Inc., its affiliates, agents, and employees, and all persons acting on its or their behalf (collectively, "Vishay"), disclaim any and all liability for any errors, inaccuracies or incompleteness contained in any datasheet or in any other disclosure relating to any product.

Vishay makes no warranty, representation or guarantee regarding the suitability of the products for any particular purpose or the continuing production of any product. To the maximum extent permitted by applicable law, Vishay disclaims (i) any and all liability arising out of the application or use of any product, (ii) any and all liability, including without limitation special, consequential or incidental damages, and (iii) any and all implied warranties, including warranties of fitness for particular purpose, non-infringement and merchantability.

Statements regarding the suitability of products for certain types of applications are based on Vishay's knowledge of typical requirements that are often placed on Vishay products in generic applications. Such statements are not binding statements about the suitability of products for a particular application. It is the customer's responsibility to validate that a particular product with the properties described in the product specification is suitable for use in a particular application. Parameters provided in datasheets and/or specifications may vary in different applications and performance may vary over time. All operating parameters, including typical parameters, must be validated for each customer application by the customer's technical experts. Product specifications do not expand or otherwise modify Vishay's terms and conditions of purchase, including but not limited to the warranty expressed therein.

Except as expressly indicated in writing, Vishay products are not designed for use in medical, life-saving, or life-sustaining applications or for any other application in which the failure of the Vishay product could result in personal injury or death. Customers using or selling Vishay products not expressly indicated for use in such applications do so at their own risk. Please contact authorized Vishay personnel to obtain written terms and conditions regarding products designed for such applications.

No license, express or implied, by estoppel or otherwise, to any intellectual property rights is granted by this document or by any conduct of Vishay. Product names and markings noted herein may be trademarks of their respective owners.

## Material Category Policy

**Vishay Intertechnology, Inc. hereby certifies that all its products that are identified as RoHS-Compliant fulfill the definitions and restrictions defined under Directive 2011/65/EU of The European Parliament and of the Council of June 8, 2011 on the restriction of the use of certain hazardous substances in electrical and electronic equipment (EEE) - recast, unless otherwise specified as non-compliant.**

**Please note that some Vishay documentation may still make reference to RoHS Directive 2002/95/EC. We confirm that all the products identified as being compliant to Directive 2002/95/EC conform to Directive 2011/65/EU.**

**Vishay Intertechnology, Inc. hereby certifies that all its products that are identified as Halogen-Free follow Halogen-Free requirements as per JEDEC JS709A standards. Please note that some Vishay documentation may still make reference to the IEC 61249-2-21 definition. We confirm that all the products identified as being compliant to IEC 61249-2-21 conform to JEDEC JS709A standards.**



Компания «ЭлектроПласт» предлагает заключение долгосрочных отношений при поставках импортных электронных компонентов на взаимовыгодных условиях!

Наши преимущества:

- Оперативные поставки широкого спектра электронных компонентов отечественного и импортного производства напрямую от производителей и с крупнейших мировых складов;
- Поставка более 17-ти миллионов наименований электронных компонентов;
- Поставка сложных, дефицитных, либо снятых с производства позиций;
- Оперативные сроки поставки под заказ (от 5 рабочих дней);
- Экспресс доставка в любую точку России;
- Техническая поддержка проекта, помощь в подборе аналогов, поставка прототипов;
- Система менеджмента качества сертифицирована по Международному стандарту ISO 9001;
- Лицензия ФСБ на осуществление работ с использованием сведений, составляющих государственную тайну;
- Поставка специализированных компонентов (Xilinx, Altera, Analog Devices, Intersil, Interpoint, Microsemi, Aeroflex, Peregrine, Syfer, Eurofarad, Texas Instrument, Miteq, Cobham, E2V, MA-COM, Hittite, Mini-Circuits, General Dynamics и др.);

Помимо этого, одним из направлений компании «ЭлектроПласт» является направление «Источники питания». Мы предлагаем Вам помощь Конструкторского отдела:

- Подбор оптимального решения, техническое обоснование при выборе компонента;
- Подбор аналогов;
- Консультации по применению компонента;
- Поставка образцов и прототипов;
- Техническая поддержка проекта;
- Защита от снятия компонента с производства.



#### Как с нами связаться

**Телефон:** 8 (812) 309 58 32 (многоканальный)

**Факс:** 8 (812) 320-02-42

**Электронная почта:** [org@eplast1.ru](mailto:org@eplast1.ru)

**Адрес:** 198099, г. Санкт-Петербург, ул. Калинина, дом 2, корпус 4, литера А.