

LOC	DIST	REVISIONS					
		P	LTN	DESCRIPTION	DATE	DMN	APVD
ES	00	M		ADDED NEW DASH NUMBER 7-0	27DEC2013	CZ	SZ
		R1		ADDED NEW DASH NUMBER 7-2	29JUN2015	CZ	SZ
		R2		ADDED NEW DASH NUMBER 7-3	28JUL2015	CZ	SZ
		R3		REV PER ECO-17-001492	03FEB2017	WY	SZ

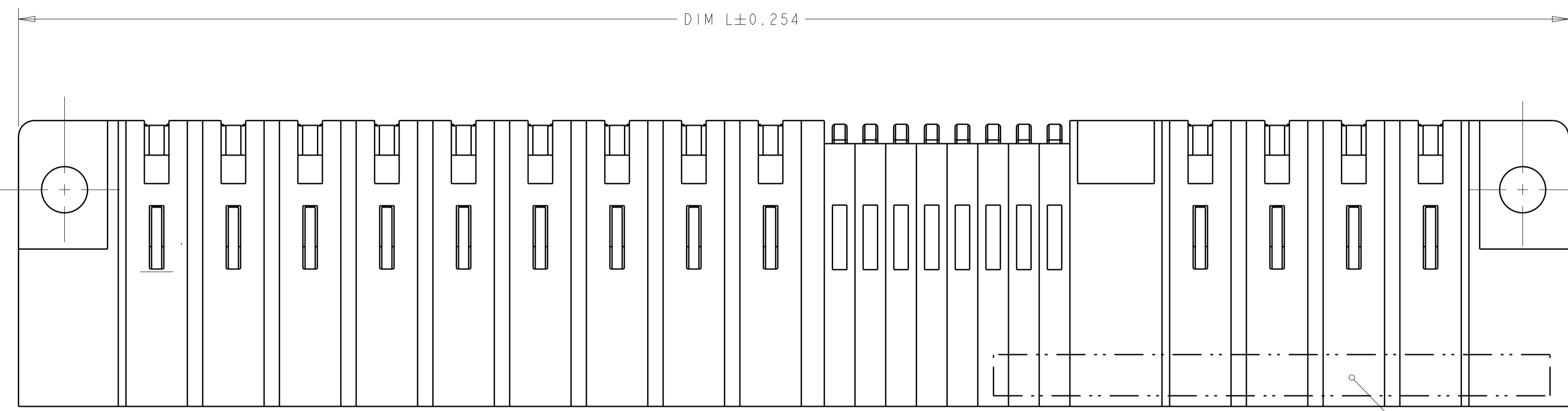

- 1 OPTIONAL CENTER MODULE WITH Ø.150 THRU HOLE OR HOLD DOWN FEATURE.
- 2 "AMP", PART NUMBER, AND DATECODE TO BE MARKED IN AREA SHOWN. PARTS UNDER 2.00 LONG MAY BE MARKED ON BOTH SIDES.
- 3 MATERIAL:
HOUSING - GLASS FILLED HIGH TEMP THERMO PLASTIC, UL94 V-0
SIGNAL CONTACT - COPPER ALLOY
POWER CONTACT - HIGH CONDUCTIVITY COPPER ALLOY
- 4 CONTACT PLATING: NOBLE METAL PLATING ON CONTACT FUNCTIONAL AREA OF POWER AND SIGNAL CONTACTS
- 5 MECHANICAL CONNECTOR KEEP OUT ZONE.
- 6 DATUM AND BASIC DIMENSIONS ESTABLISHED BY CUSTOMER.
- 7 PCB - HOLE DIAMETERS ARE FINISHED HOLE SIZE.
- 8 PCB - .0453±.0010 DRILLED HOLES PLATED WITH .0003 MIN Sn OVER .001 TO .003 Cu PLATING TO ACHIEVE A .040 DIA HOLE.
- 10 VARIABLE DIMENSIONS SHOWN ON VIEW (SHEET 5,11)

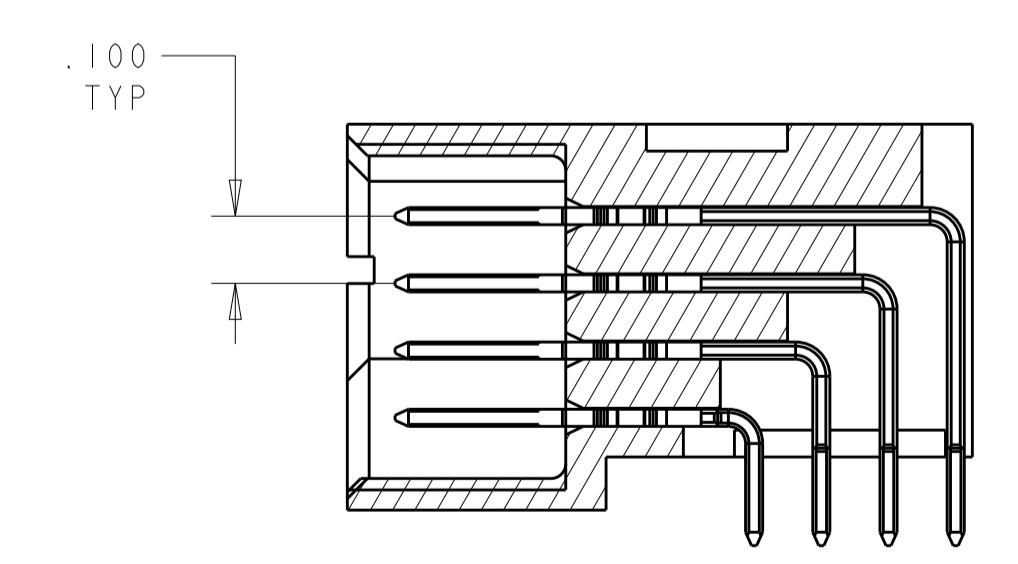
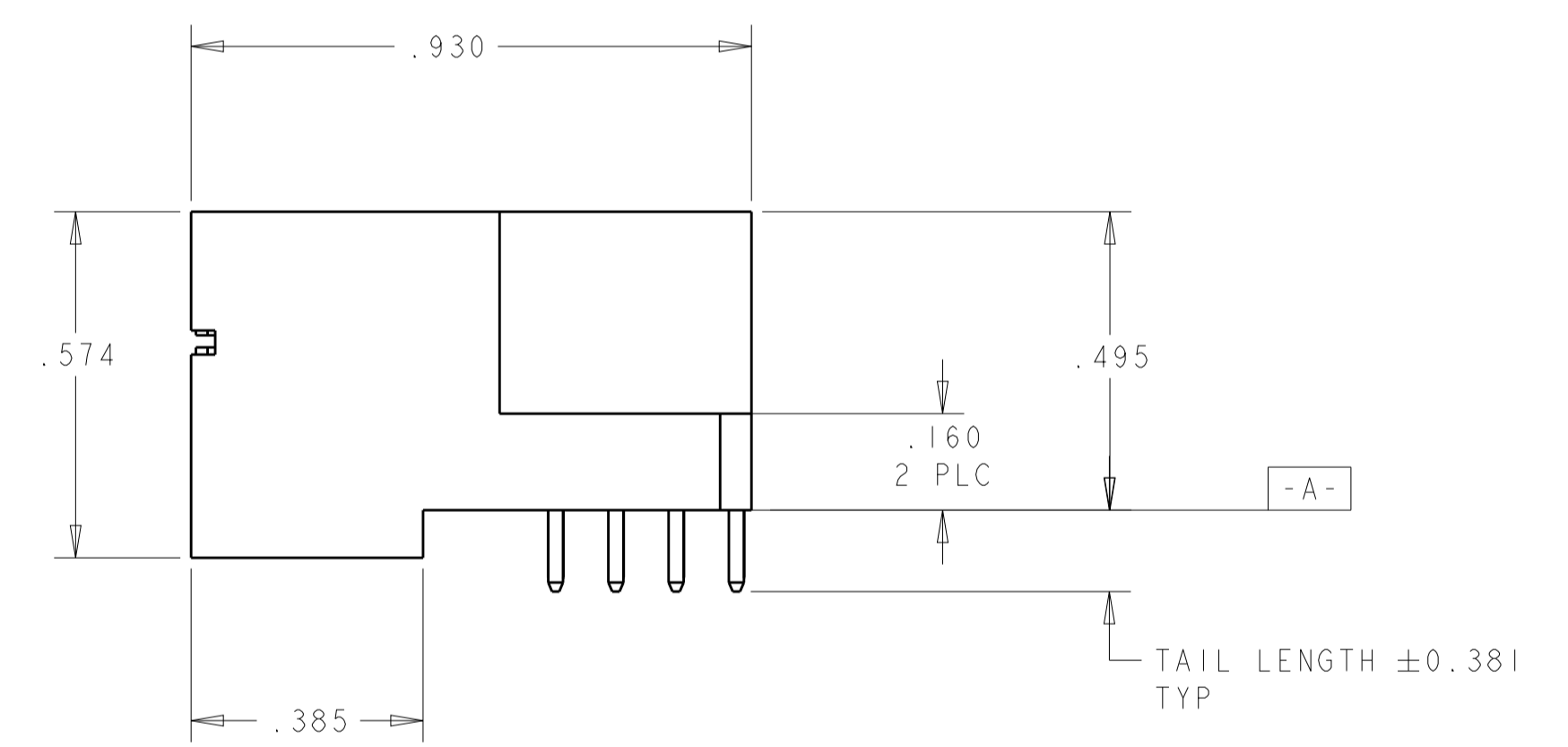
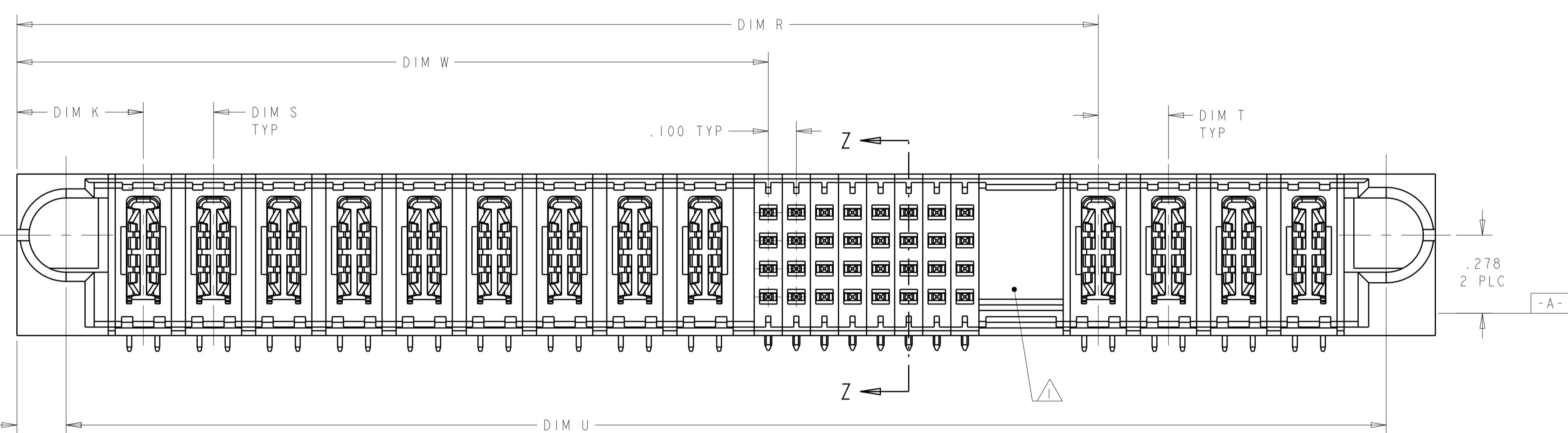

SECTION Z-Z

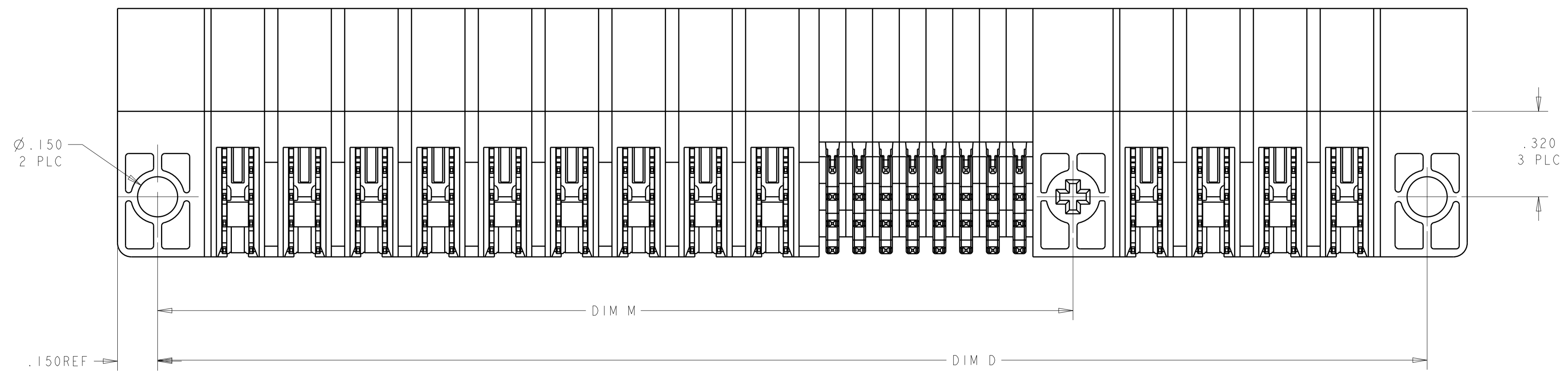

THIS DRAWING IS A CONTROLLED DOCUMENT.

DIMENSIONS: INCHES 0 PLC ±. 1 PLC ±.01 2 PLC ±.01 3 PLC ±.005 4 PLC ±.0020 ANGLES ±.020 FINISH	TOLERANCES UNLESS OTHERWISE SPECIFIED: 0 PLC ±. 1 PLC ±.01 2 PLC ±.01 3 PLC ±.005 4 PLC ±.0020 ANGLES ±.020 FINISH	DWN R.GRZYBOWSKI 28FEB05 CHK M.PERCHEK 28FEB05 APVD M.PERCHEK NAME PRODUCT SPEC 108-1973 APPLICATION SPEC 114-13038 WEIGHT CUSTOMER DRAWING	TE Connectivity STE RIGHT ANGLE HEADER ASSEMBLY SOLDER TAILS, W/GUIDES MULTI-BEAM XL SIZE CAGE CODE DRAWING NO RESTRICTED TO A100779C=6450330 SCALE 4:1 SHEET 1 OF 20 REV R3
--	---	--	--

LOC	DIST	REVISIONS			
ES	00	REV	DATE	BY	APPD
-	-	SEE SHEET 1	-	-	-

1.575	-	-	1.425	.700	1.625	-	1.925	.475	IP + 24S + 1P	6-6450330-7
1.575	-	-	1.425	.700	1.625	-	1.925	.475	IP + 24S + 1P	6-6450330-6
1.800	-	-	1.700	.625	1.850	-	2.150	.450	IP + 40S + 1P	6-6450330-5
1.550	.250	.250	1.200	.900	1.600	-	1.900	.450	2P + 8S + 2P	6-6450330-4
1.300	-	-	1.200	.675	1.350	-	1.650	.450	IP + 16S + 1P	6-6450330-3
2.300	.250	.250	1.700	1.175	2.350	-	2.650	.450	3P + 16S + 3P	6-6450330-1
7.350			5.225	3.925	7.400	-	7.700	.475	12P + 48S + 8P	6-6450330-0
2.600	.250	.250	2.250	1.925	2.650	-	2.950	.450	6P + 8S + 2P	5-6450330-9
4.500	.300	.300	2.875	2.175	4.550	-	4.850	.475	6ACP + 24S + 6ACP	5-6450330-8
2.400	.200	.200	2.100	.825	2.450	-	2.750	.450	2P + 48S + 2P	5-6450330-7
1.700	.250	.250	1.350	.875	1.750	-	2.050	.450	2P + 16S + 2P	5-6450330-6
1.200	-	-	1.100	.625	1.250	-	1.550	.450	IP + 16S + 1P	5-6450330-5
3.550	.200		2.225	1.925	3.600	-	3.900	.500	7P + 8S + 7P	5-6450330-4
2.900	.250	.250	2.050	1.375	2.950	-	3.250	.450	4P + 24S + 4P	5-6450330-3
2.400	.250	.250	1.800	1.125	2.450	-	2.750	.450	3P + 24S + 3P	5-6450330-2
1.700	.250	.250	1.350	.875	1.750	-	2.050	.450	2P + 16S + 2P	5-6450330-1
2.800	.250	.300	2.075	1.375	2.850	-	3.150	.450	4P + 24S + 3ACP	5-6450330-0
1.700	.250	.250	1.350	.875	1.750	-	2.050	.450	2P + 16S + 2P	4-6450330-9
1.575	.250	.250	1.425	.700	1.625	-	1.925	.475	IP + 24S + 1P	4-6450330-7
1.600	.250	.250	1.250	.925	1.650	-	1.950	.450	2P + 8S + 2P	4-6450330-6
2.400	.250	.250	2.050	1.375	2.450	-	2.750	.450	4P + 24S + 2P	4-6450330-2
2.400	.250	.250	1.800	1.125	2.450	-	2.750	.450	3P + 24S + 3P	3-6450330-9
3.000	.250	.250	2.150	1.425	3.050	-	3.350	.450	4P + 24S + 4P	3-6450330-7
2.400	.250	.250	1.550	.875	2.450	-	2.750	.450	2P + 24S + 4P	3-6450330-5
.700	-	-	-	.375	.750	-	1.050	-	0P + 16S + 0P	3-6450330-1
2.800	.300	.250	1.950	1.275	2.850	-	3.150	.475	3ACP + 24S + 4P	2-6450330-8
2.800	.300	.300	2.075	1.325	2.850	-	3.150	.475	3ACP + 24S + 3ACP	2-6450330-6
3.300	.250	.250	2.450	1.375	3.350	-	3.650	.450	4P + 40S + 4P	2-6450330-3
2.700	.200	.200	2.000	1.225	2.750	-	3.050	.450	4P + 28S + 4P	1-6450330-8
2.000	.250	.250	1.650	.925	2.050	-	2.350	.450	2P + 24S + 2P	1-6450330-4
3.150	.250	.250	2.300	1.625	3.200	-	3.500	.450	5P + 24S + 4P	1-6450330-3
.900	-	-	-	.375	.950	-	1.250	-	0P + 24S + 0P	1-6450330-2
1.575	.250	.250	1.425	.700	1.625	-	1.925	.475	IP + 24S + 1P	1-6450330-1
4.000			2.750	2.075	4.050	-	4.350	.450	2ACP + 5P + 24S + 6P	1-6450330-0
2.800	.250	.250	1.950	1.375	2.850	-	3.150	.450	4P + 20S + 4P	6450330-9
1.575	.250	.250	1.425	.700	1.625	-	1.925	.475	IP + 24S + 1P	6450330-8
3.300	.300	.250	1.950	1.275	3.350	-	3.650	.475	3ACP + 24S + 6P	6450330-7
1.900	NA	NA	.975	.625	1.950	-	2.250	.450	IP + 12S + 5P	6450330-6
4.000	NA	NA	2.750	2.075	4.050	-	4.350	.450	3ACP + 4P + 24S + 6P	6450330-5
2.550	.300	.250	2.150	1.525	2.600	-	2.900	.475	3ACP + 1P + 24S + 2P	6450330-4
4.350	.250	.250	3.500	2.625	4.400	-	4.700	.450	9P + 32S + 4P	6450330-3
1.575	.250	.250	1.425	.700	1.625	-	1.925	.475	IP + 24S + 1P	6450330-1
U	S	T	R	W	D	M	L	K	DESCRIPTION	PART NUMBER

2.000	.250	.250	1.650	.925	2.050	-	2.350	.450	2P + 24S + 2P	7-6450330-3
2.500	.250	.250	2.150	1.425	2.550	-	2.850	.450	4P + 24S + 2P	7-6450330-2
2.400	.250	.250	1.800	1.125	2.450	-	2.750	.450	3P + 24S + 3P	7-6450330-0
1.200	-	-	1.100	.625	1.250	-	1.550	.450	IP + 16S + 1P	6-6450330-9
4.125	.300	.250	2.775	1.900	4.175	-	4.475	.475	5ACP + 32S + 6P	6-6450330-8
U	S	T	R	W	D	M	L	K	DESCRIPTION	PART NUMBER

THIS DRAWING IS A CONTROLLED DOCUMENT. **TE Connectivity**

OWNER: R. GRZYBOWSKI 28FEB05
 CHK: M. PERCHERKE 28FEB05
 APVD: M. PERCHERKE

RIGHT ANGLE HEADER ASSEMBLY
 SOLDER TAILS, W/GUIDES
 MULTI-BEAM XL

PRODUCT SPEC: 108-1973
 APPLICATION SPEC: 114-13038

SIZE: A1 00779 C=6450330
 SCALE: 4:1 SHEET 2 OF 20 REV: R3

THIS DRAWING IS UNPUBLISHED. RELEASED FOR PUBLICATION 20
 COPYRIGHT 20 BY - TE CONNECTIVITY ALL RIGHTS RESERVED.

PART NUMBER	ROWS	POWER						SIGNAL						POWER		
		P1	1	2	3	4	5	6	P2	1	2	3	4	5	6	P2
6450330-1	D C B A	PM	J	J	J	J	J	J	J	J	J	J	J	J	PM	
			K	K	K	K	K	K	K	K	K	K	K			
			N	N	N	N	N	N	N	N	N	N	N			
			S	S	S	S	S	S	S	S	S	S	S			
IP + 24S + IP																

PART NUMBER	ROWS	POWER						SIGNAL						POWER		
		P1	1	2	3	4	5	6	P2	1	2	3	4	5	6	P2
4-6450330-7	D C B A	PM	E	E	E	E	E	J	E	E	E	E	E	J	PM	
			F	F	F	F	F	K	F	F	F	F	K			
			N	N	N	N	N	N	N	N	N	N	N			
			S	S	S	S	S	S	S	S	S	S	S			
IP + 24S + IP																

PART NUMBER	ROWS	POWER				SIGNAL						POWER	
		P1	P2	P3	P4	1	2	3	4	5	6	P5	P6
6450330-4	D C B A	PM	PM	PM	PM	E	J	J	J	J	E	PM	PM
						K	K	F	K	K	K		
						N	N	N	N	N	N		
						H	S	S	S	S	H		
3ACP + IP + 24S + 2P													

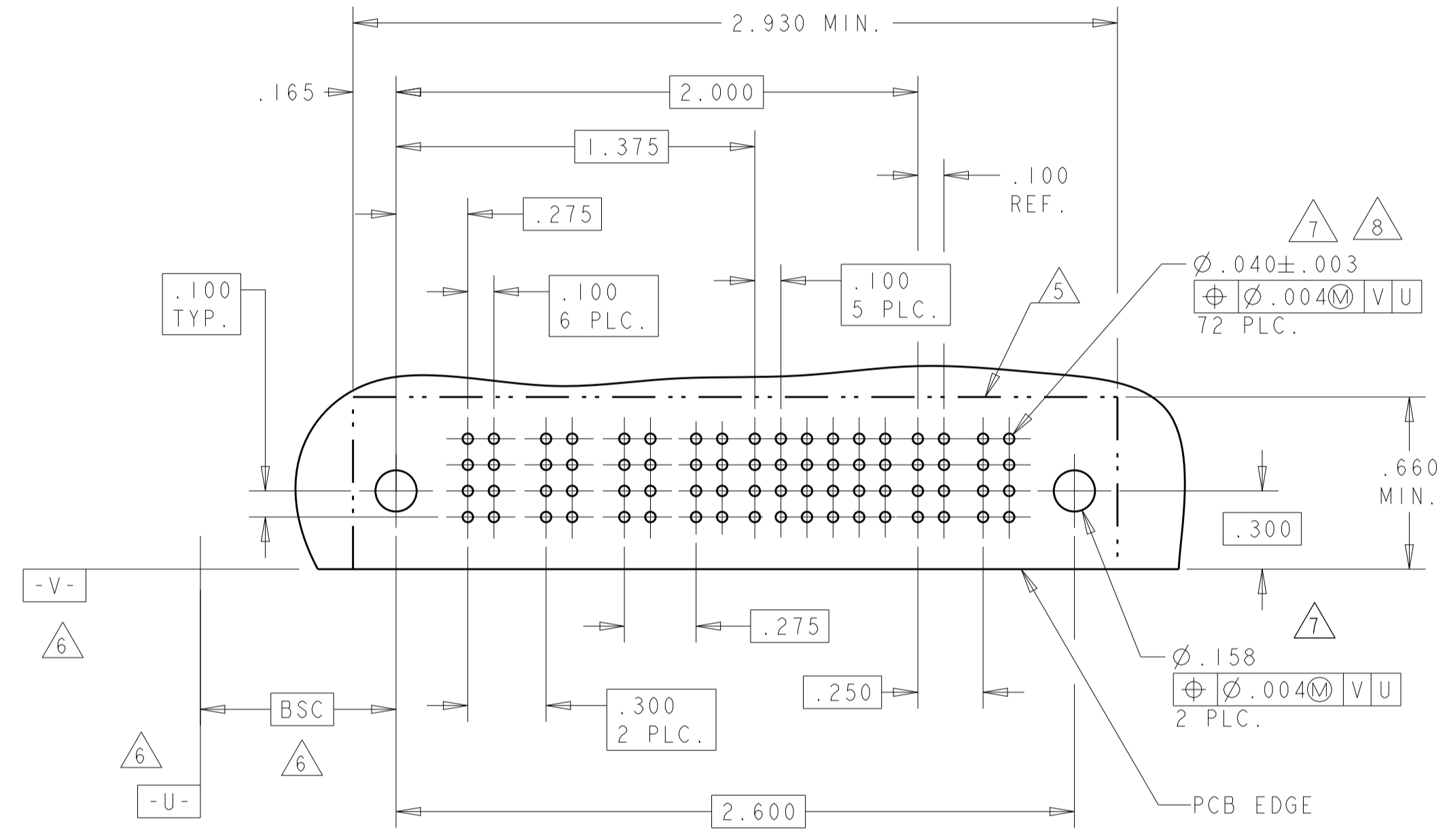
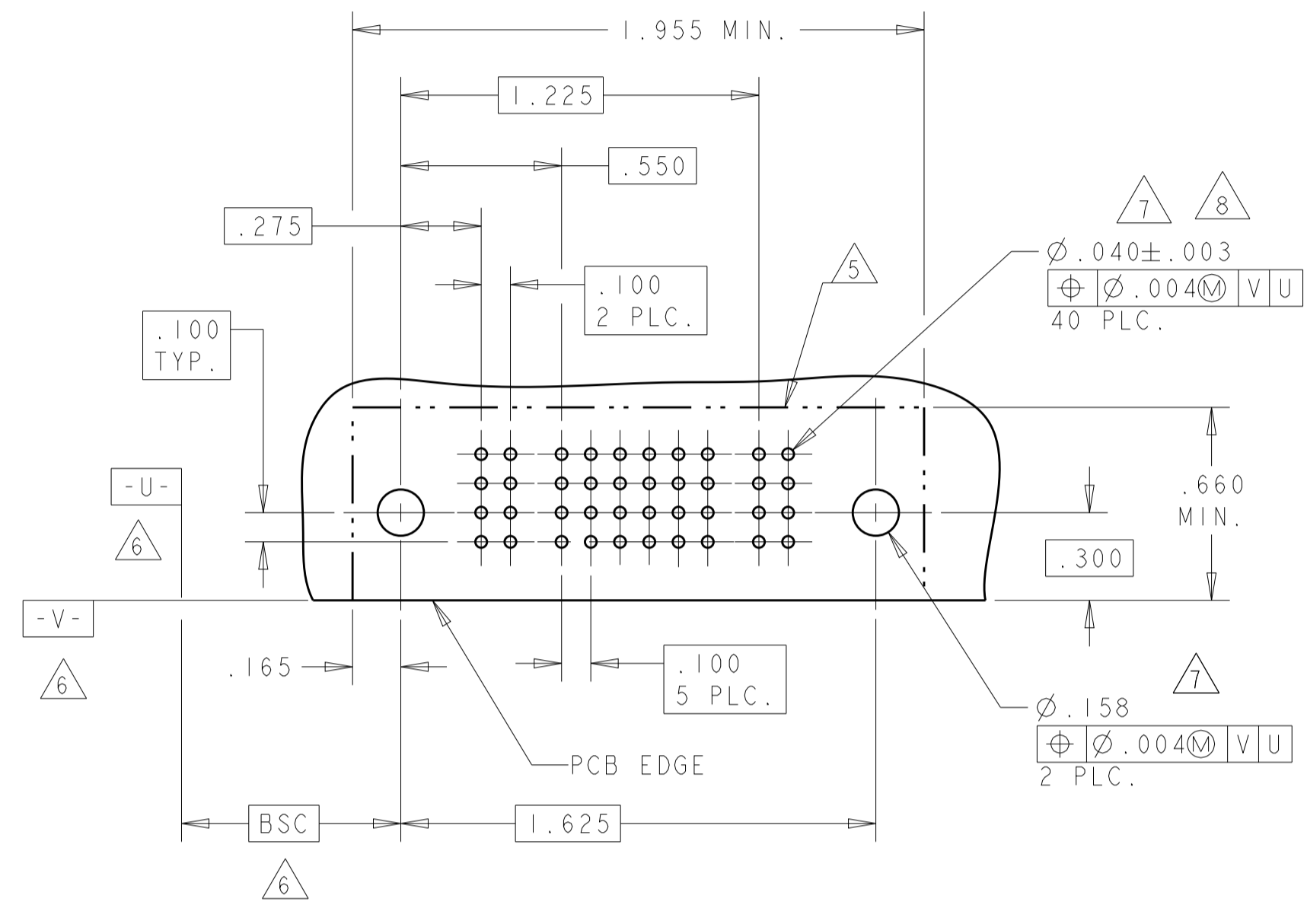

6450330-1 AND 4-6450330-7 SHARE THE SAME LAYOUT

NO CONTACT LOADED

PART NUMBER	ROWS	POWER									SIGNAL								POWER			
		P1	P2	P3	P4	P5	P6	P7	P8	P9	1	2	3	4	5	6	7	8	P10	P11	P12	P13
6450330-3	D C B A	PM	PM		PM	PM	PM	PM	PM	J	J	J	J	J	E	E	E	PM	PM	PM	PM	
										K	K	K	K	K	K	K	K					
										N	N	N	N	N	N	N	N					
										S	S	S	S	S	S	S	S					
9P + 32S + 4P																						

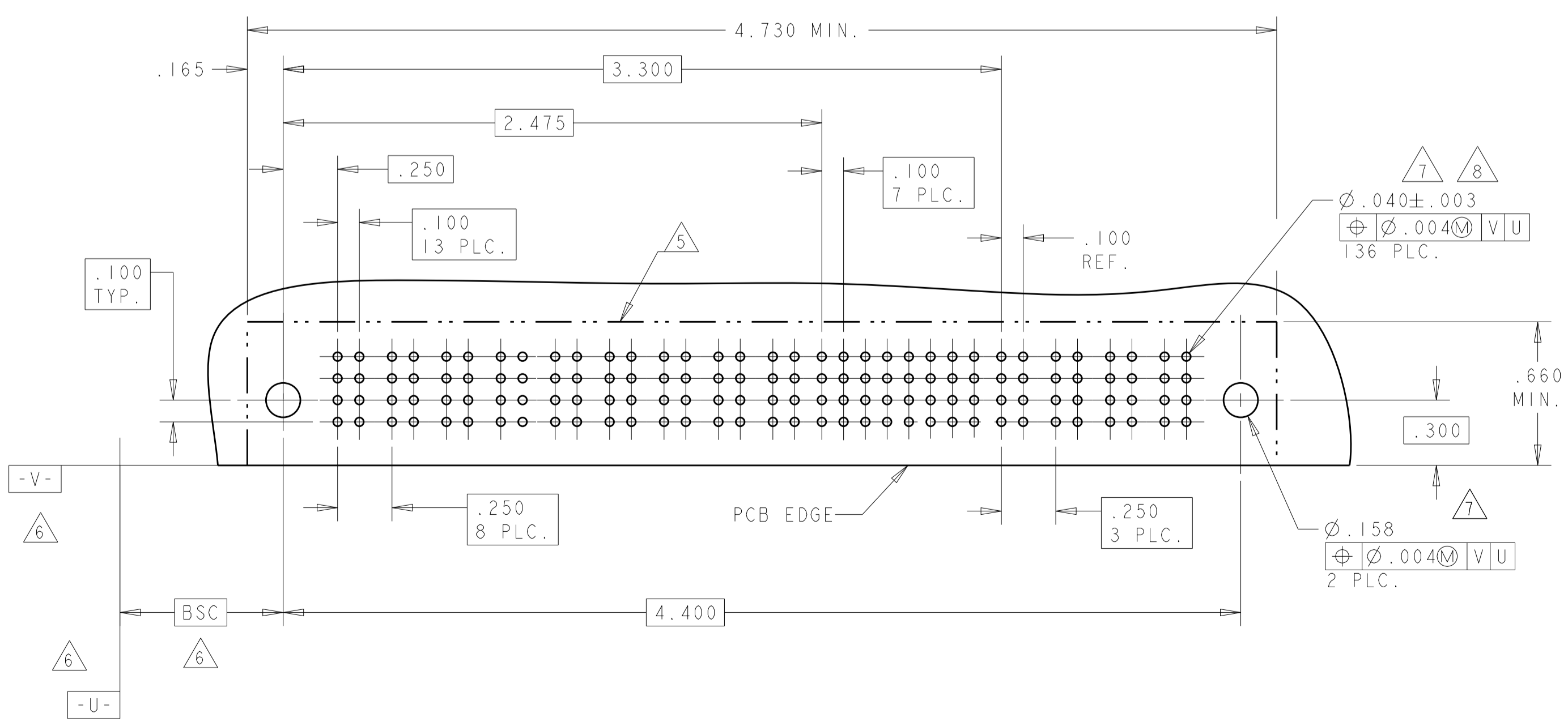

FS	MFBL	.135	A
Z	STD	.090	D
Y	STD	.090	C
R	STD	.090	B
O	STD	.090	A
A4	MLBF	.090	D
A3	MLBF	.090	C
A2	MLBF	.090	B
A1	MLBF	.090	A
FS	MFBL	.135	A
E	MLBF	.135	D
F	MLBF	.135	C
G	MLBF	.135	B
H	MLBF	.135	A
J	STD	.135	D
K	STD	.135	C
N	STD	.135	B
S	STD	.135	A
CODE	MATING SEQUENCE	TAIL LENGTH	ROW

PA	.090
PM	.135
CODE	TAIL LENGTH
POWER CONTACT	

THIS DRAWING IS A CONTROLLED DOCUMENT. DIMENSIONS: INCHES. TOLERANCES UNLESS OTHERWISE SPECIFIED: 0 PLC +/- .01, 1 PLC +/- .01, 2 PLC +/- .01, 3 PLC +/- .005, 4 PLC +/- .002. MATERIAL: FINISH: .

OWN: R. GRZYBOWSKI 28FEB05
CHK: M. PERCHERKE 28FEB05
APVD: M. PERCHERKE

NAME: RIGHT ANGLE HEADER ASSEMBLY SOLDER TAILS, W/GUIDES MULTI-BEAM XL

PRODUCT SPEC: 108-1973
APPLICATION SPEC: 114-13038
WEIGHT: A100779
SCALE: 4:1 SHEET 3 OF 20 REV: R3

LOC	DIST	REVISIONS					
ES	00	P	LTH	DESCRIPTION	DATE	DMN	APVD
		-	-	SEE SHEET 1	-	-	-

PART NUMBER	ROWS	POWER						SIGNAL						POWER							
		P1	P2	P3	P4	P5	P6	P7	1	2	3	4	5	6	P8	P9	P10	P11	P12	P13	
6450330-5	D	PM	PM	PM	PM	PM	PM	J	J	J	J	J	J	PM	PM	PM	PM	PM	PM		
	C							K	K	K	K	K	K								
	B							N	N	N	N	N	N								
	A							S	S	S	S	S	H								
3ACP + 4P + 24S + 6P																					

PART NUMBER	ROWS	POWER			SIGNAL			POWER				
		P1	1	2	3	P2	P3	P4	P5	P6		
6450330-6	D	PM	J	J	J	PM	PM	PM	PM	PM		
	C		K	K	K							
	B		N	N	N							
	A		S	S	S							
1P + 12S + 5P												

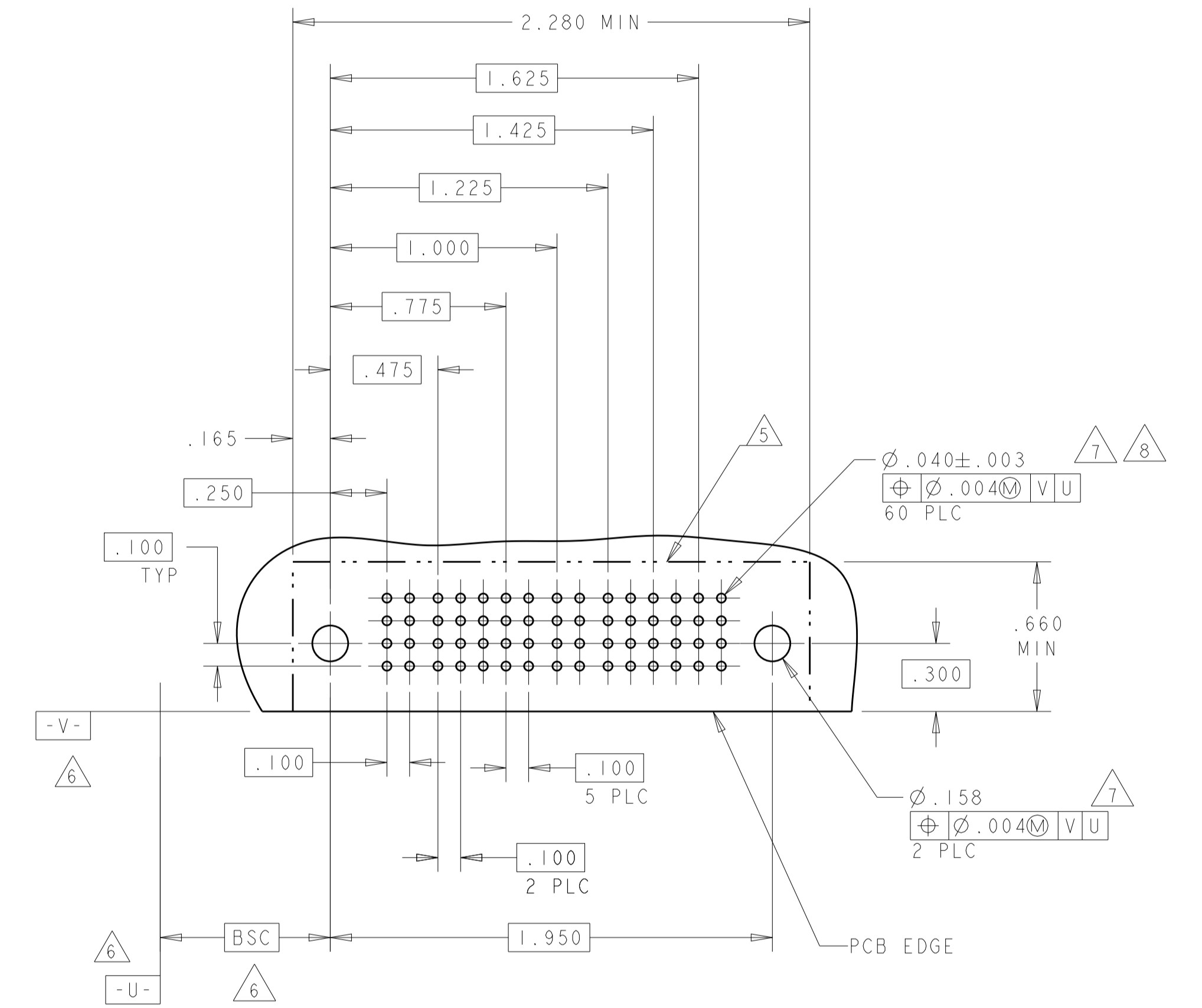
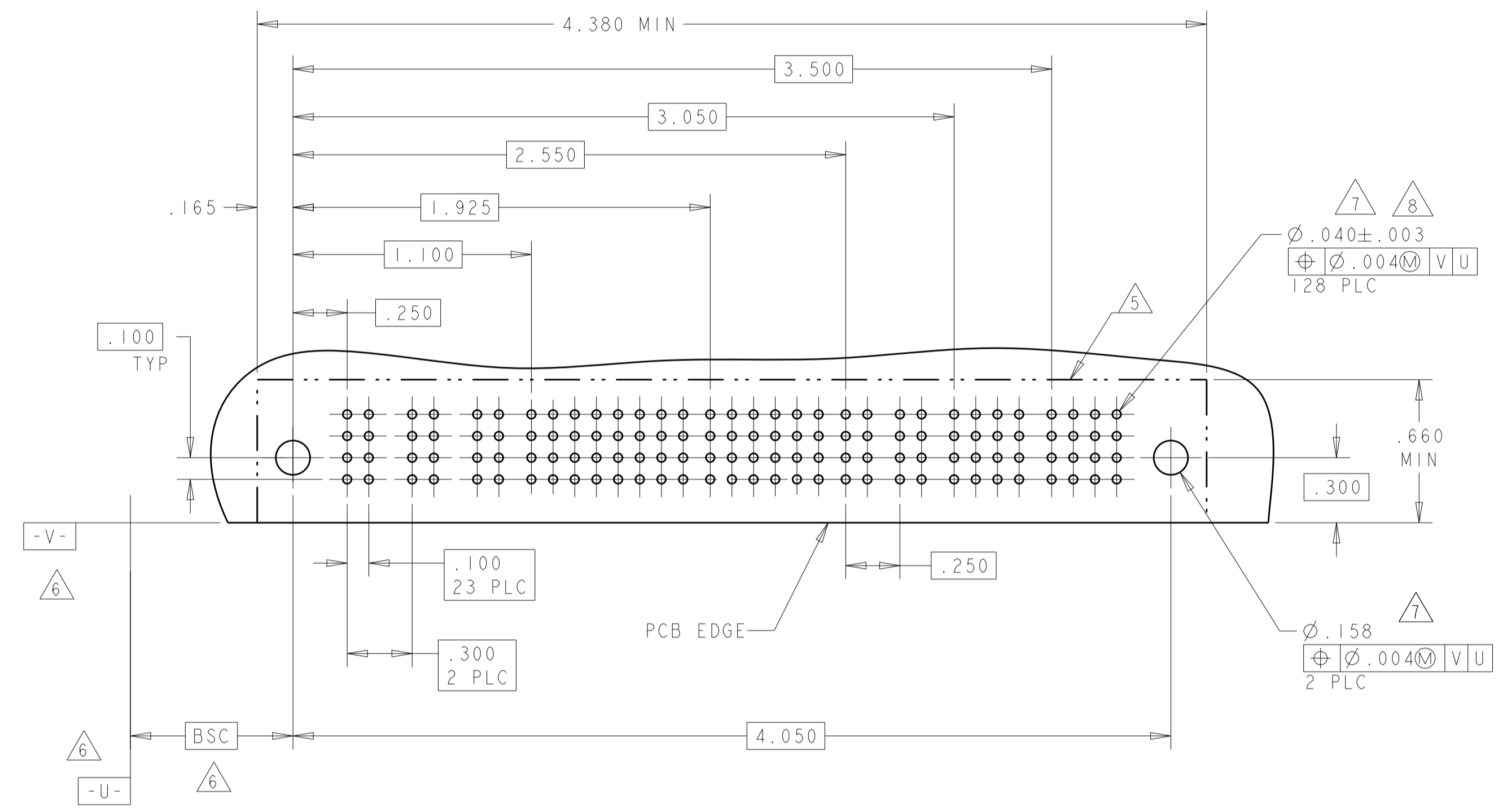
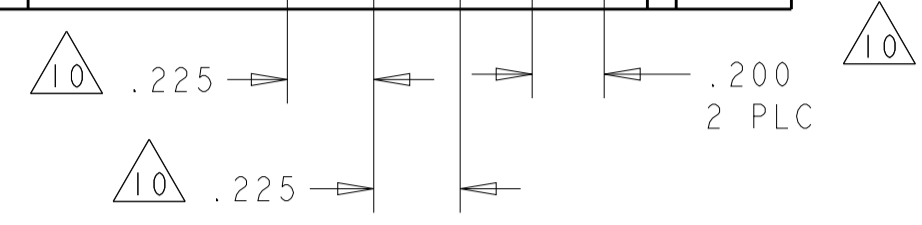

THIS DRAWING IS A CONTROLLED DOCUMENT.		DMN: R.GRZYBOWSKI 28FEB05	TE Connectivity
DIMENSIONS: INCHES		CHK: M.PERCHEK 28FEB05	
TOLERANCES UNLESS OTHERWISE SPECIFIED:		APVD: M.PERCHEK	NAME: RIGHT ANGLE HEADER ASSEMBLY SOLDER TAILS, W/GUIDES MULTI-BEAM XL
0 PLC ±. 1 PLC ±.01 2 PLC ±.01 3 PLC ±.005 4 PLC ±.002 ANGLES ±.020		PRODUCT SPEC: 108-1973	SIZE: 114-13038
MATERIAL: FINISH:		APPLICATION SPEC: 114-13038	RESTRICTED TO: -
		WEIGHT: -	SCALE: 4:1
		CUSTOMER DRAWING	SHEET 4 OF 20

LOC	DIST	REVISIONS			
P	LTN	DESCRIPTION	DATE	DMN	APVD
ES	00	SEE SHEET 1			

PART NUMBER	ROWS	POWER			SIGNAL						POWER						
		P1	P2	P3	1	2	3	4	5	6	P4	P5	P6	P7	P8	P9	
6450330-7	D	PM	PM	PM	J	J	J	J	J	J	PM	PM	PM	PM	PM	PM	PM
	C				K	K	K	K	K	K							
	B				N	N	N	N	N	N							
A	H	S	S	S	S	S											

3ACP + 24S + 6P

PART NUMBER	ROWS	POWER				SIGNAL					POWER				
		P1	P2	P3	P4	1	2	3	4	5	P5	P6	P7	P8	
6450330-9	D	PM	PM	PM	PM	J	J	J	J	J	PM	PM	PM	PM	PM
	C					K	K	K	K	K					
	B					N	N	G	N	N					
A	S	S	S	S	S										

4P + 20S + 4P

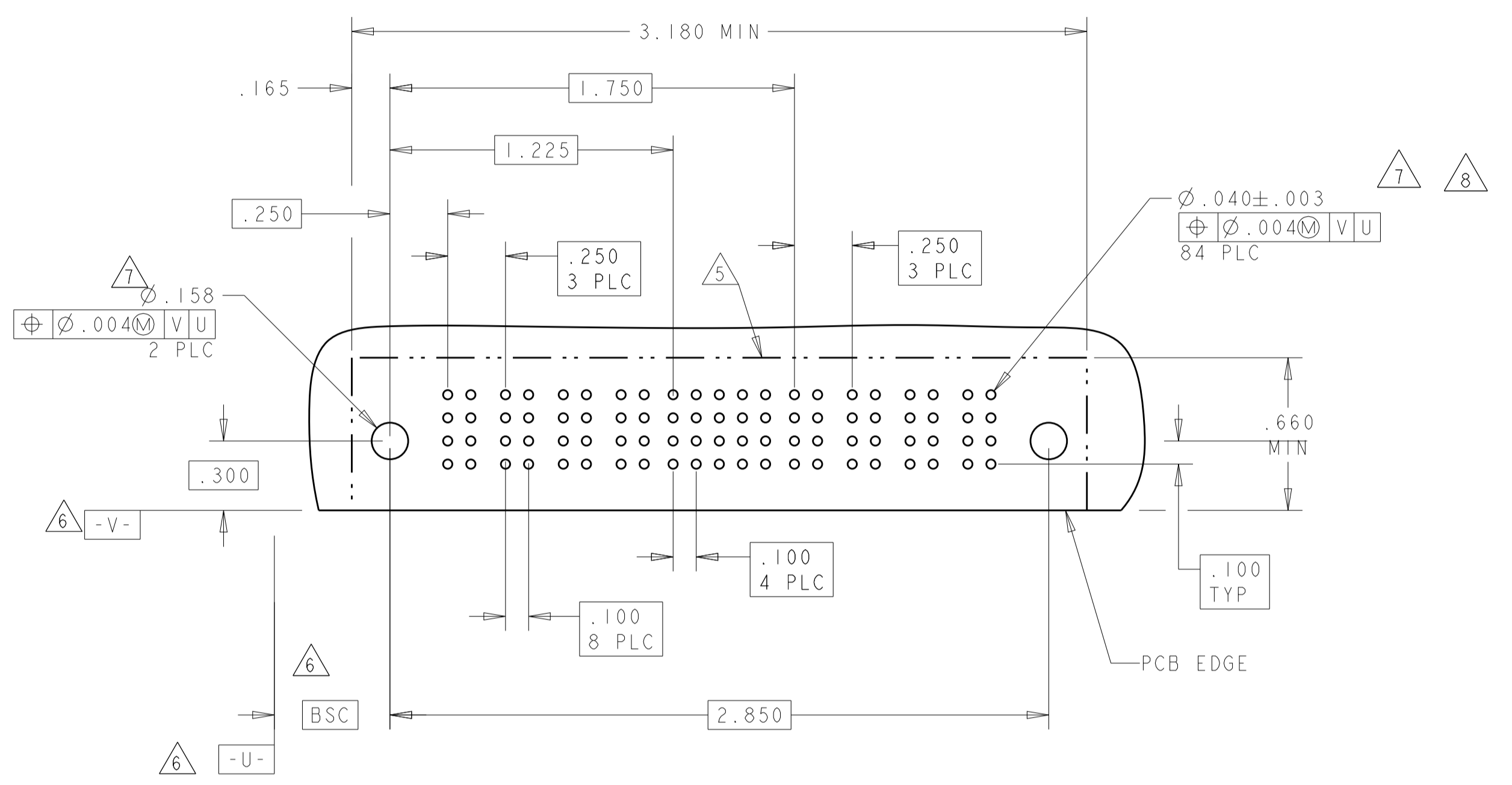
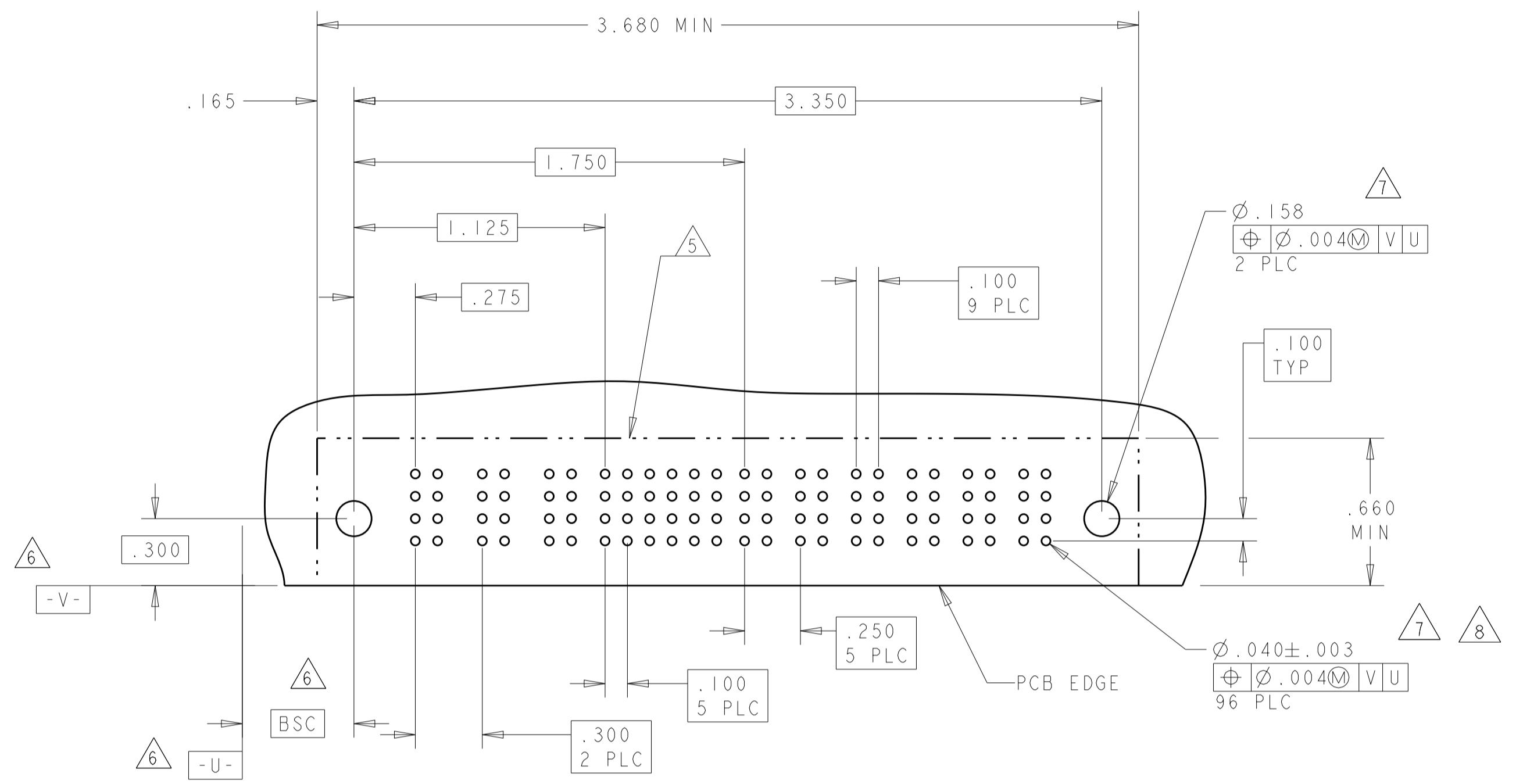

PART NUMBER	ROWS	POWER		SIGNAL						POWER	
		P1	P2	1	2	3	4	5	6	P1	P2
6450330-8	D	PM	PM	J	J	J	J	J	J	PM	PM
	C			K	K	K	K	K	K		
	B			N	N	G	G	N	G		
	A			S	S	H	S	S	S		

1P + 24S + 1P

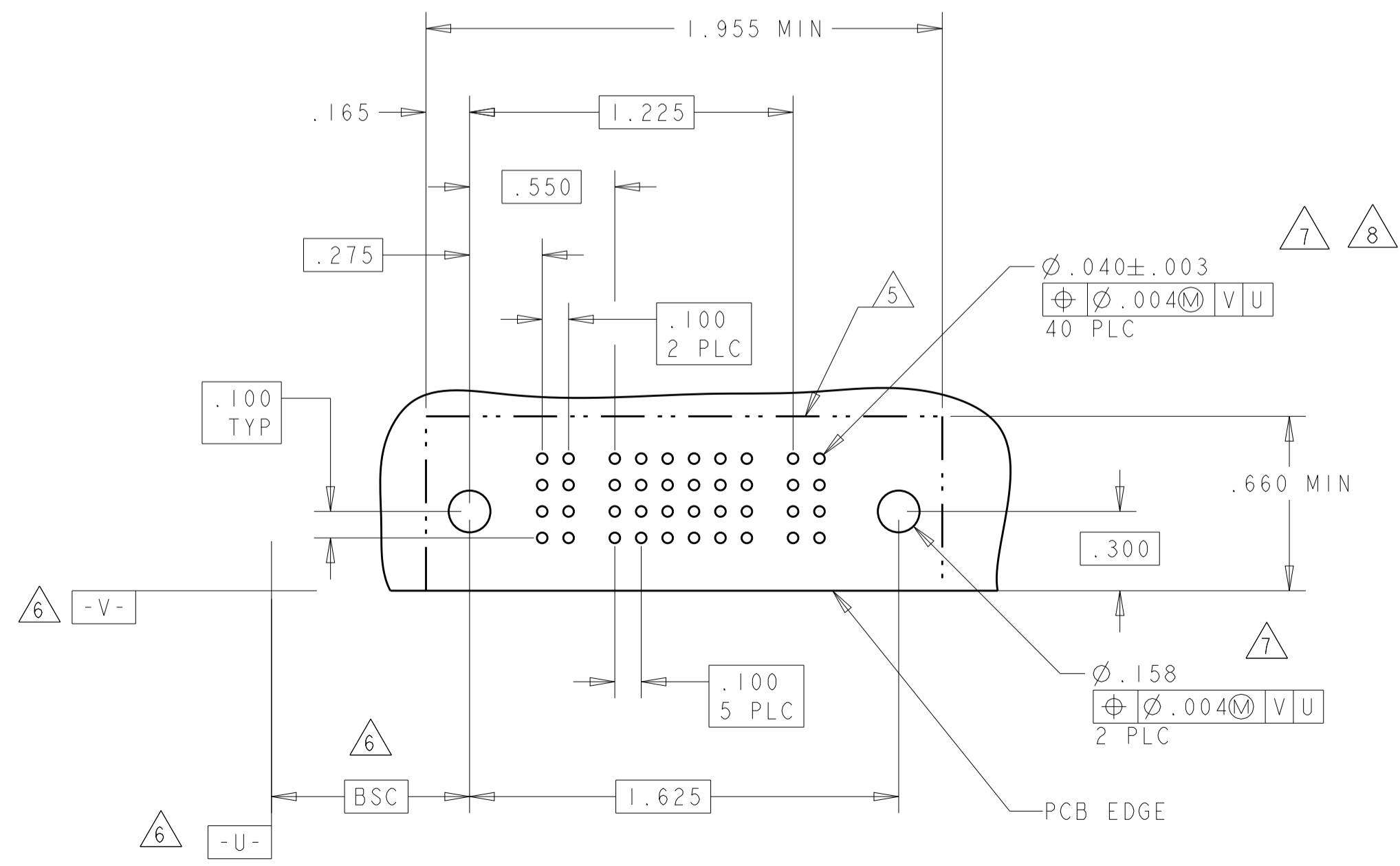

THIS DRAWING IS A CONTROLLED DOCUMENT.		DMN: R.GRZYBOWSKI 28FEB05	TE Connectivity
DIMENSIONS: INCHES		CHK: M.PERCHEKKE 28FEB05	
DIMENSIONS: INCHES 0 PLC ±. 1 PLC ±.01 2 PLC ±.01 3 PLC ±.005 4 PLC ±.0020 ANGLES ±.2°		APVD: M.PERCHEKKE NAME: RIGHT ANGLE HEADER ASSEMBLY PRODUCT SPEC: 108-1973 APPLICATION SPEC: 114-13038 WEIGHT: - CUSTOMER DRAWING	
MATERIAL: -		SIZE: A1 CAGE CODE: 100779 DRAWING NO: 6450330 SCALE: 4:1 SHEET 5 OF 20 REV: R3	

LOC	DIST	REV	DATE	APPV
ES	00			
P LTH		REVISIONS		
-		SEE SHEET 1		

PART NUMBER	ROWS	POWER						SIGNAL						POWER					
		P1	P2	P3	P4	P5	P6	P7	1	2	3	4	5	6	P8	P9	P10	P11	P12
I-6450330-0	D C B A	PM	PM	PM	PM	PM	PM	J	J	J	J	J	J	PM	PM	PM	PM	PM	PM
		PM	PM	PM	PM	PM	PM	K	K	K	K	K	K	PM	PM	PM	PM	PM	PM
		PM	PM	PM	PM	PM	PM	N	N	N	N	N	N	PM	PM	PM	PM	PM	PM
		PM	PM	PM	PM	PM	PM	S	S	S	S	S	H	PM	PM	PM	PM	PM	PM

PART NUMBER	ROWS	POWER						SIGNAL						POWER		
		P1	1	2	3	4	5	6	P2	1	2	3	4	5	6	P2
I-6450330-1	D C B A	PM	J	J	J	J	J	J	PM	F	K	K	K	K	F	PM
		PM	N	N	N	N	N	N	PM	N	N	N	N	N	N	PM
		PM	S	S	S	S	S	S	PM	S	S	S	S	S	S	PM
		PM	S	S	S	S	S	S	PM	S	S	S	S	S	S	PM

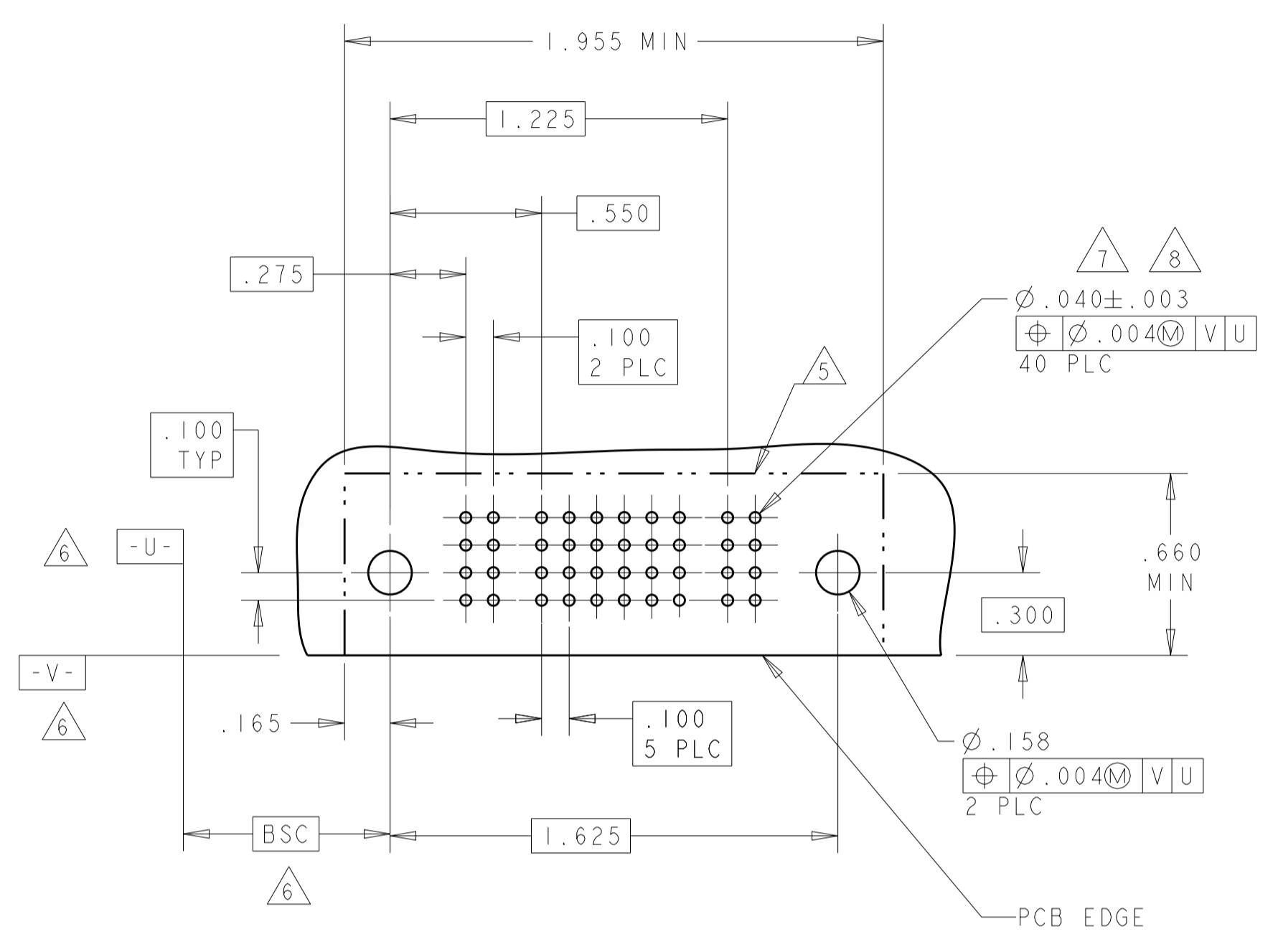
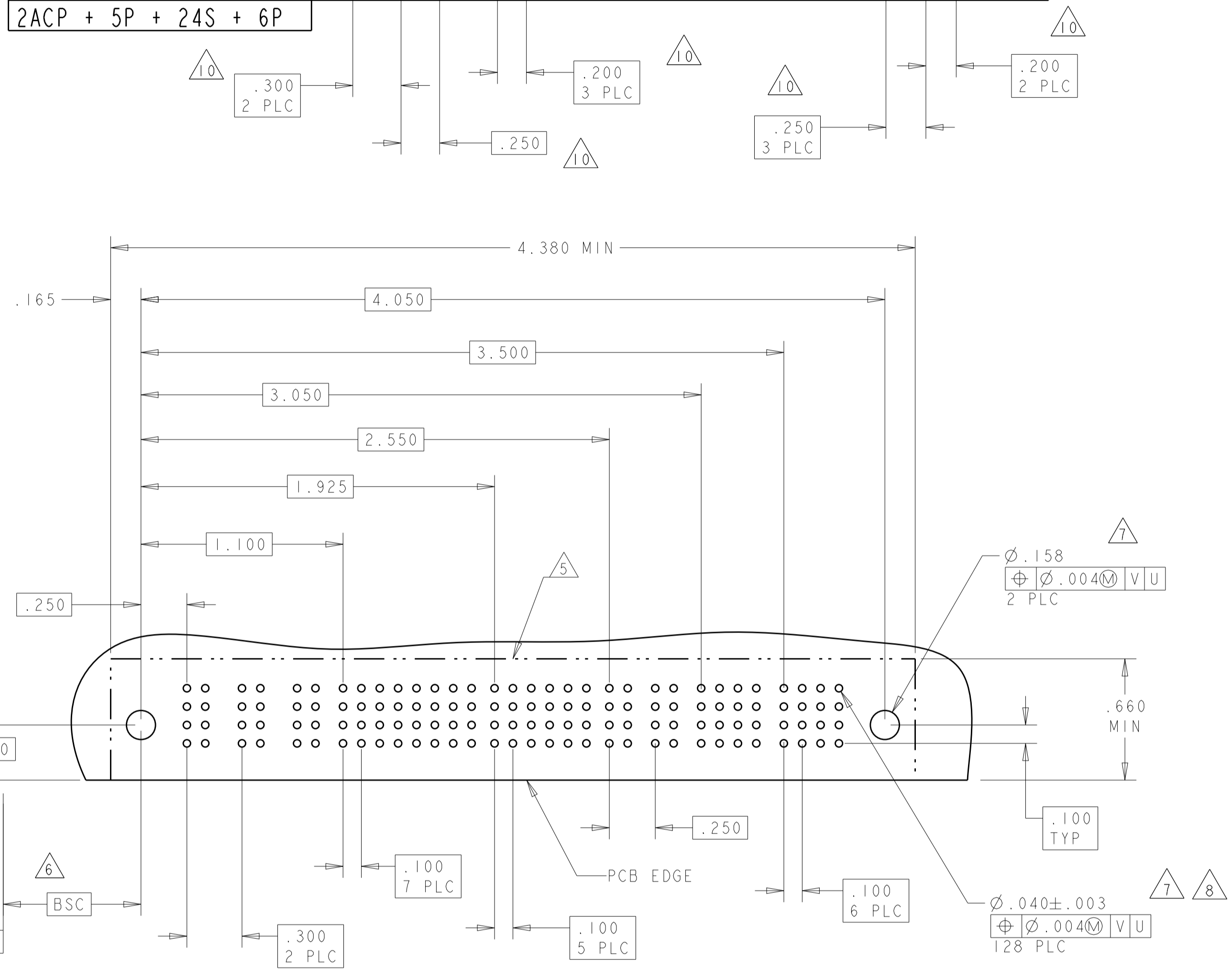

PART NUMBER	ROWS	SIGNAL					
		1	2	3	4	5	6
I-6450330-2	D C B A	Z	Z	Z	Z	Z	Z
		Y	Y	Y	Y	Y	Y
		O	O	O	O	O	O

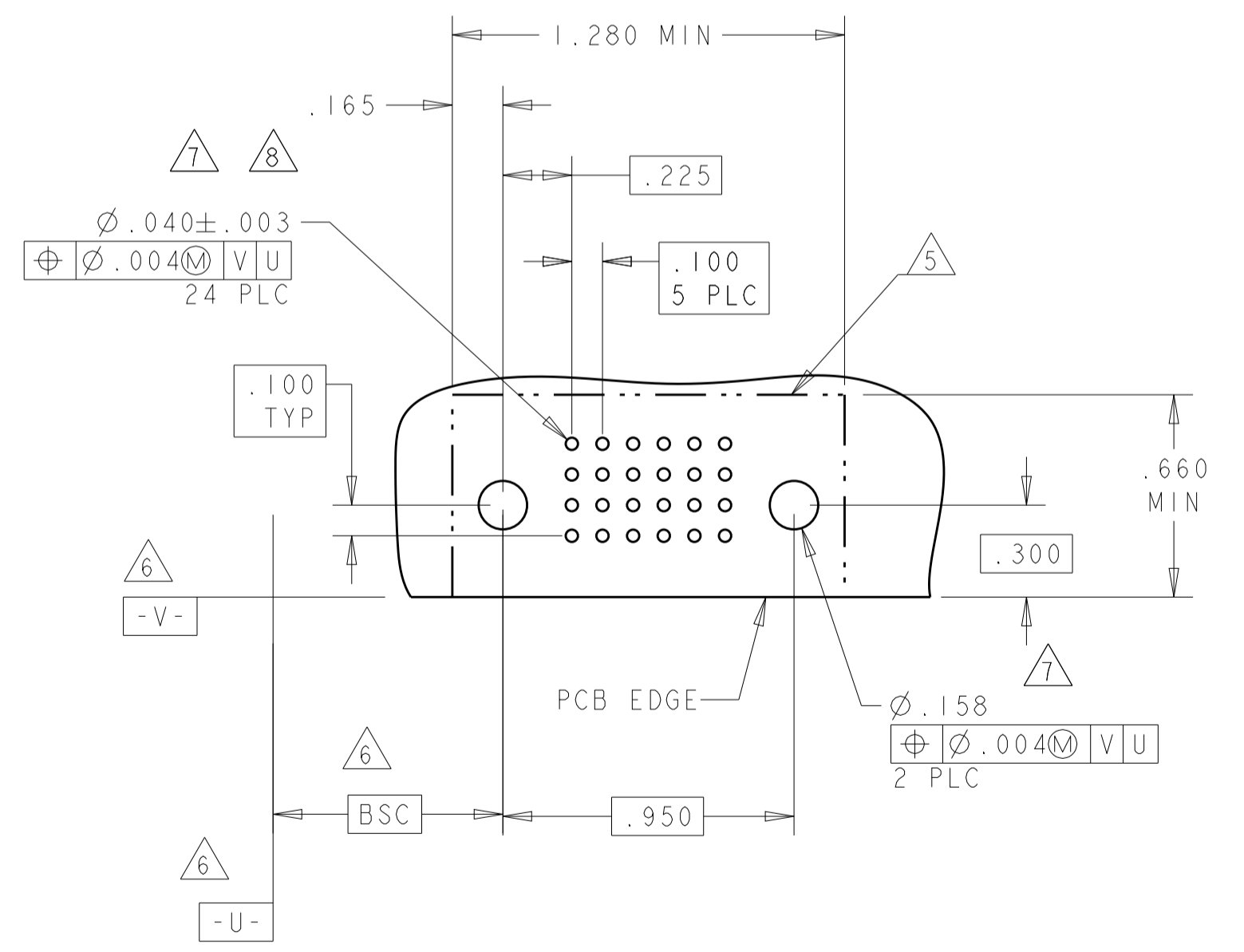

THIS DRAWING IS A CONTROLLED DOCUMENT. DWN: R. GRZYBOWSKI 28FEB05
 CHK: M. PERCHERKE 28FEB05
 APVD: M. PERCHERKE

DIMENSIONS: INCHES
 TOLERANCES UNLESS OTHERWISE SPECIFIED:
 0 PLC ±.01
 1 PLC ±.01
 2 PLC ±.01
 3 PLC ±.005
 4 PLC ±.005
 ANGLES ±.0020

MATERIAL: FINISH: *

NAME: RIGHT ANGLE HEADER ASSEMBLY SOLDER TAILS, W/GUIDES MULTI-BEAM XL
 PRODUCT SPEC: 108-1973
 APPLICATION SPEC: 114-13038
 WEIGHT: -

SCALE: 4:1 SHEET 6 OF 20 REV: R3

CUSTOMER DRAWING

PART NUMBER	ROWS	POWER					SIGNAL						POWER			
		P1	P2	P3	P4	P5	1	2	3	4	5	6	P6	P7	P8	P9
I-6450330-3	D C B A	PA	PA	PA	PA	Z	Z	Z	Z	Z	Z	PA	PA	PA	PA	
						Y	Y	Y	Y	Y	Y					
						R	R	R	R	R	R					
		5P + 24S + 4P														

PART NUMBER	ROWS	POWER				SIGNAL							POWER			
		P1	P2	P3	P4	1	2	3	4	5	6	7	P5	P6	P7	P8
I-6450330-8	D C B A	PM	PM	PM	PM	J	J	J	J	J	J	J	PM	PM	PM	PM
						K	K	K	K	K	K	K				
						N	N	N	G	N	N	N				
						S	S	S	S	S	S	S				
		4P + 28S + 4P														

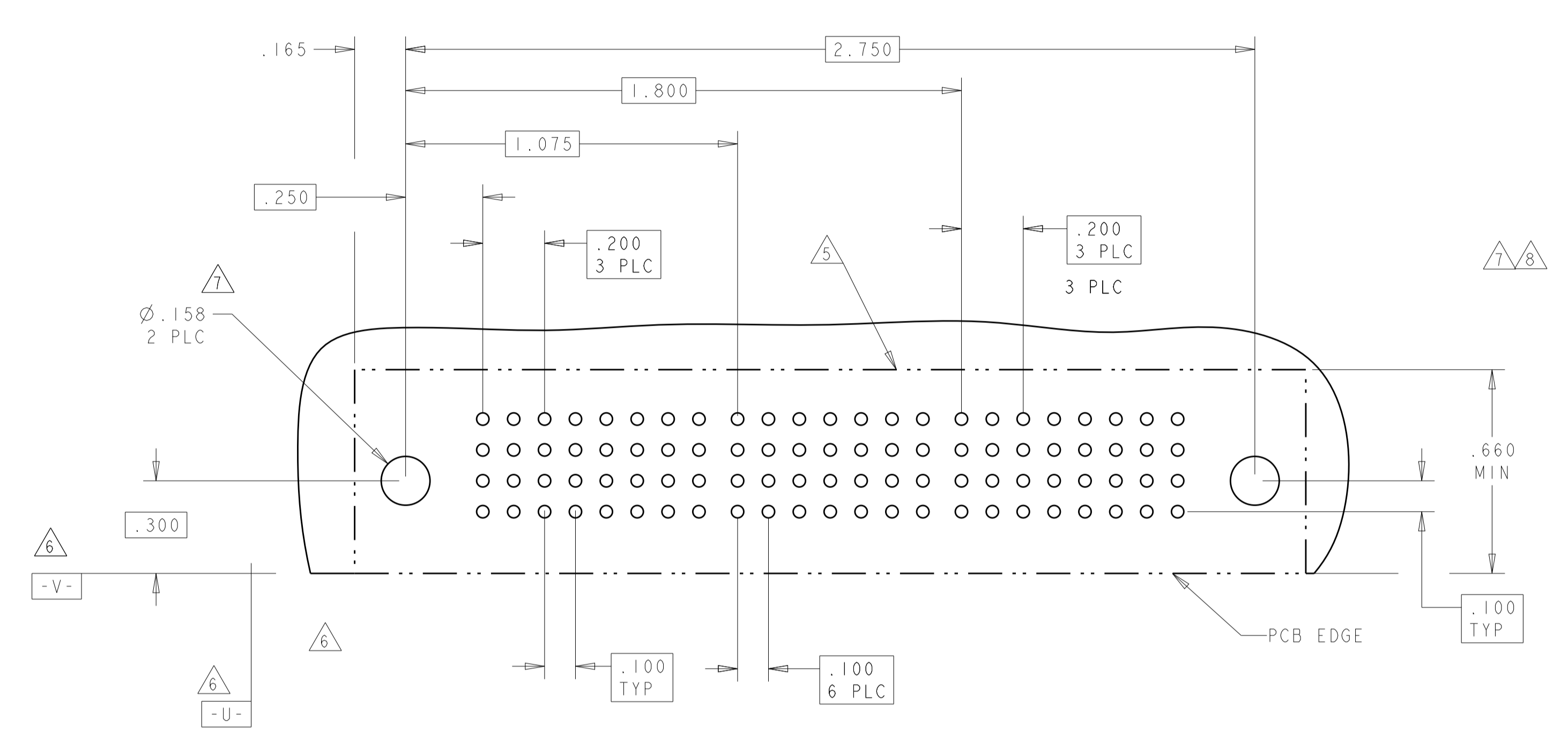
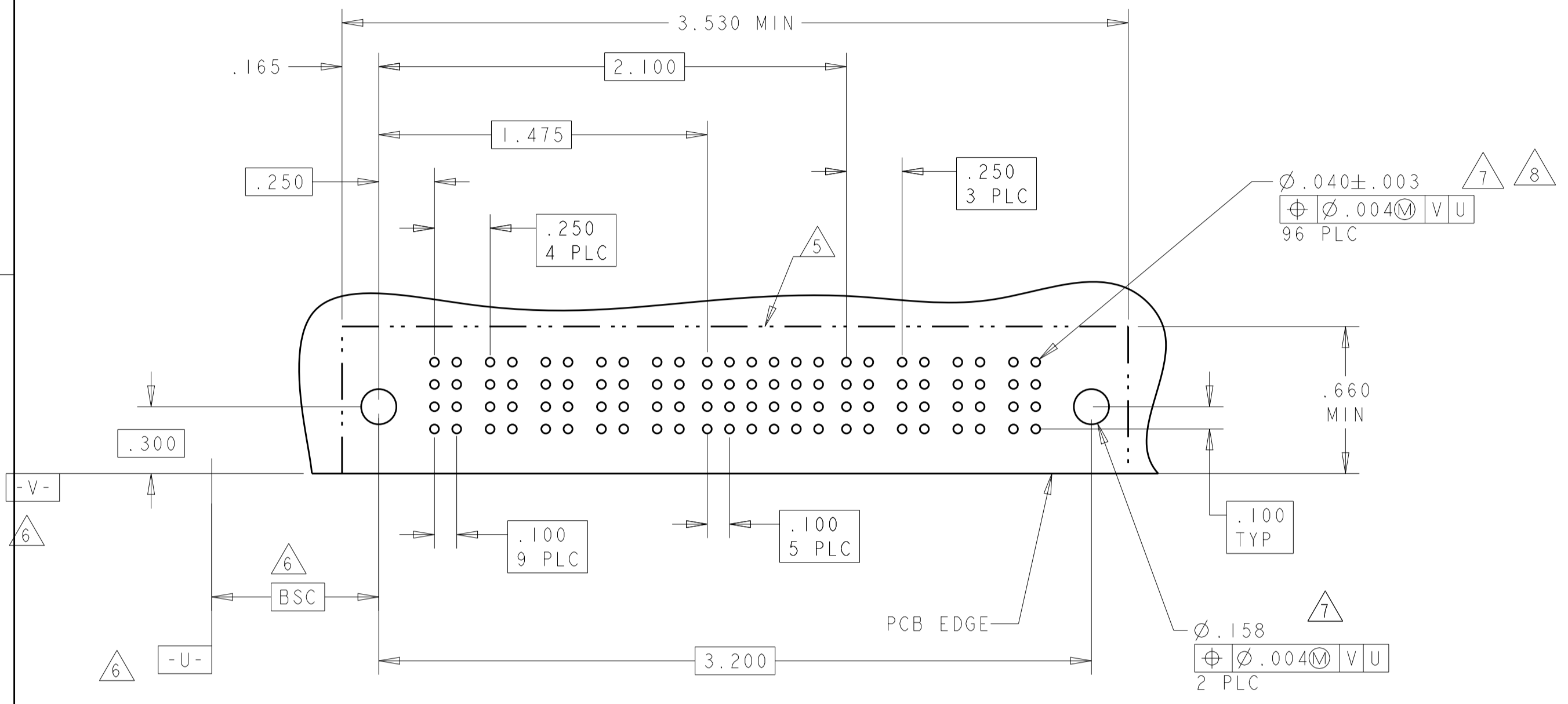

PART NUMBER	ROWS	POWER		SIGNAL						POWER	
		P1	P2	1	2	3	4	5	6	P3	P4
I-6450330-4	D C B A	PM	PM	J	J	E	J	J	J	PM	PM
				K	K	K	K	K	K		
				N	N	G	N	N	N		
				S	S	S	S	S	S		
		2P + 24S + 2P									

PART NUMBER	ROWS	POWER		SIGNAL						POWER	
		P1	P2	1	2	3	4	5	6	P3	P4
7-6450330-3	D C B A	PM	PM	J	J	J	J	J	J	PM	PM
				K	K	K	K	K	K		
				N	N	N	N	N	N		
				H	H	H	H	H	H		
		2P + 24S + 2P									

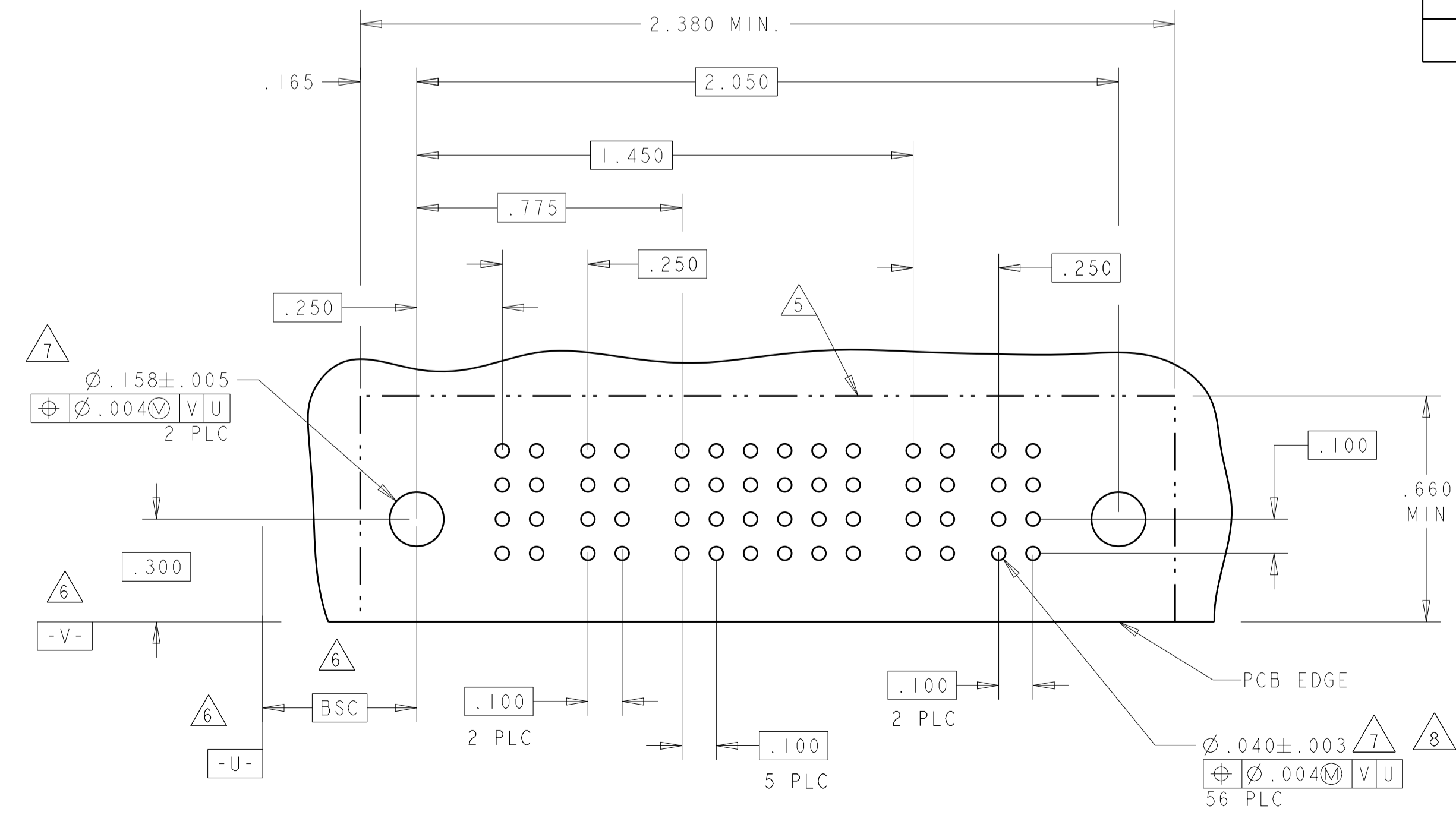

1-6450330-4 & 7-6450330-3 PCB LAYOUT

THIS DRAWING IS A CONTROLLED DOCUMENT.		OWN: R. GRZYBOWSKI 28FEB05	TE Connectivity
DIMENSIONS: INCHES		CHK: M. PERCHERKE	
TOLERANCES UNLESS OTHERWISE SPECIFIED:		APVD: M. PERCHERKE	NAME: RIGHT ANGLE HEADER ASSEMBLY SOLDER TAILS, W/GUIDES MULTI-BEAM XL
0 PLC ±.01		PRODUCT SPEC: 108-1973	SIZE: A1
1 PLC ±.01		APPLICATION SPEC: 114-13038	CAGE CODE: 6450330
2 PLC ±.01		WEIGHT: -	RESTRICTED TO: -
3 PLC ±.005		CUSTOMER DRAWING	SCALE: 4:1
4 PLC ±.002			SHEET 7 OF 20
ANGLES ±.020			REV: R3

LOC	DIST	REV	DATE	APPV
ES	00			

REVISIONS			
REV	DATE	APPV	DESCRIPTION
-	-	-	SEE SHEET 1

PART NUMBER	ROWS	POWER				SIGNAL										POWER					
		P1	P2	P3	P4	1	2	3	4	5	6	7	8	9	10	P5	P6	P7	P8		
2-6450330-3	D C B A	PM	PM	PM	PM	J	J	J	J	J	J	J	J	J	J	J	J	J	J	J	
						K	K	K	K	K	K	K	K	K	K	K	K	K	K	K	
						N	N	N	N	N	N	N	N	N	N	N	N	N	N	N	N
						H	S	S	S	S	S	S	S	S	S	S	S	S	S	S	H
4P + 40S + 4P																					

PART NUMBER	HOUSING P/N	ROWS	POWER		SIGNAL		POWER	
			P1	P2	1	2	P3	P4
4-6450330-6	4-1450310-5	D C B A	PM	PM	J	J	PM	PM
					K	K		
					N	N		
					S	S		
2P + 8S + 2P								

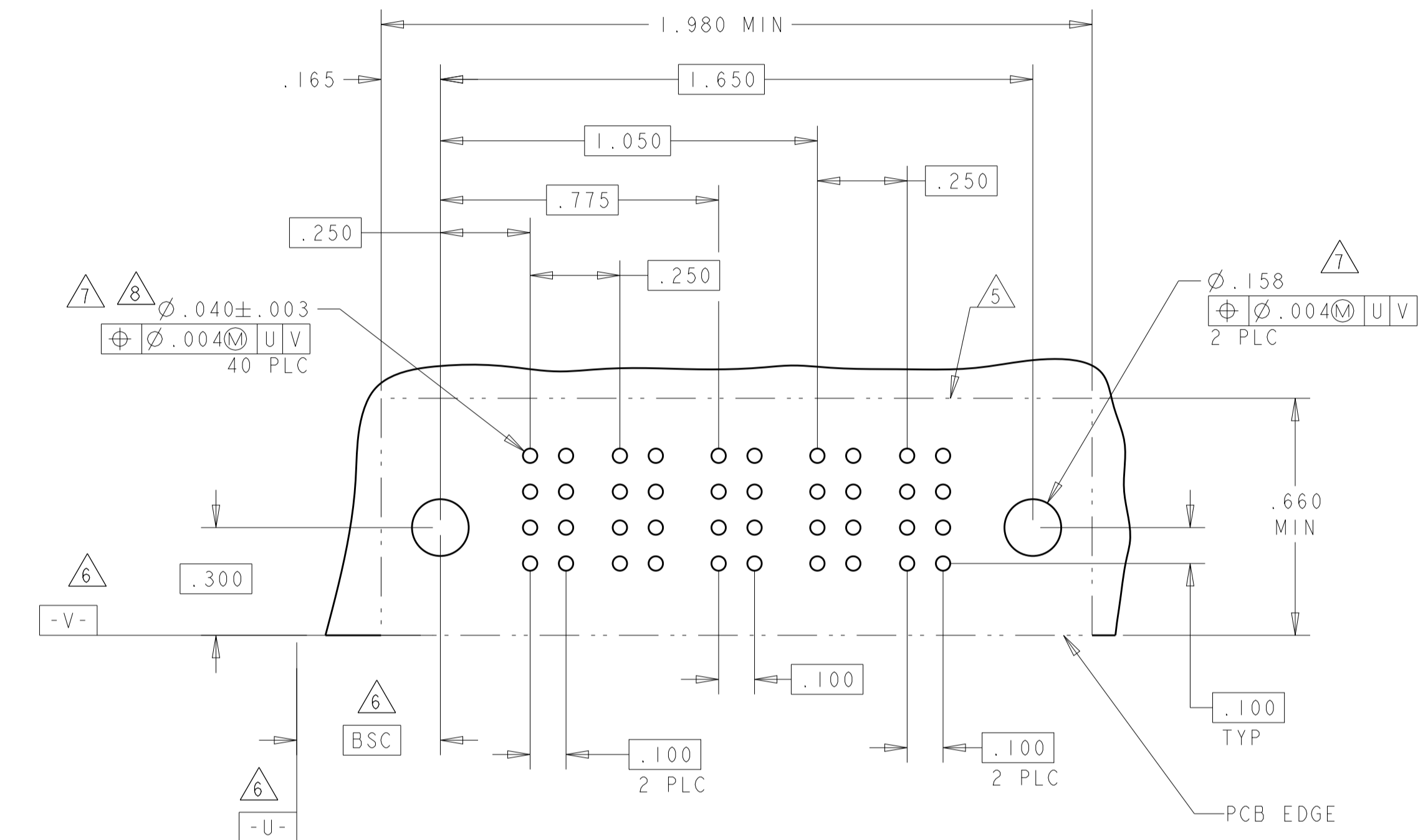
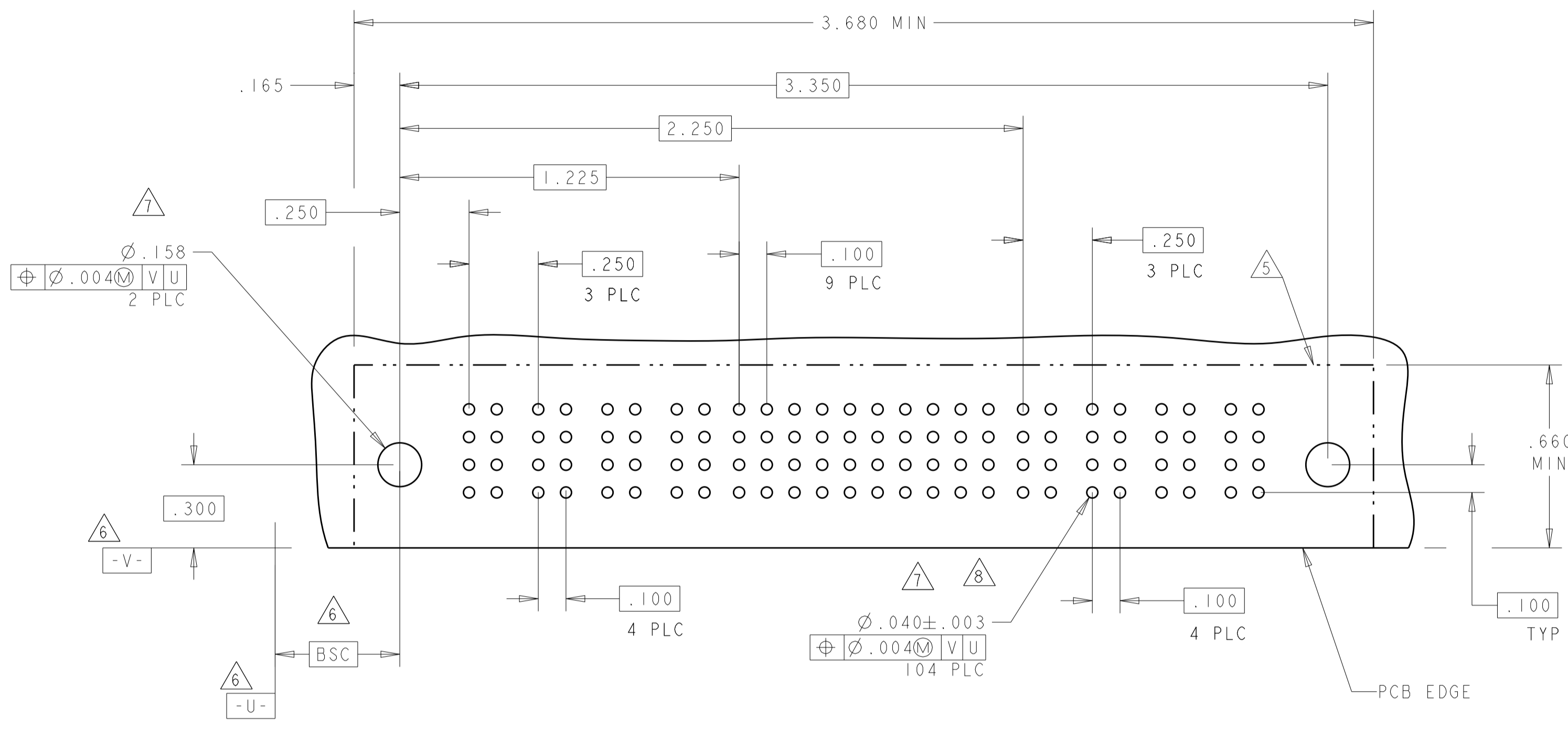

PART NUMBER	ROWS	POWER			SIGNAL						POWER				
		P1	P2	P3	1	2	3	4	5	6	P4	P5	P6	P7	
2-6450330-8	D C B A	PM	PM	PM	J	J	J	J	J	J	PM	PM	PM	PM	
					K	K	K	K	K	K					
					N	N	N	N	N	N	N				
					H	S	S	S	S	S	S				
3ACP + 24S + 4P															

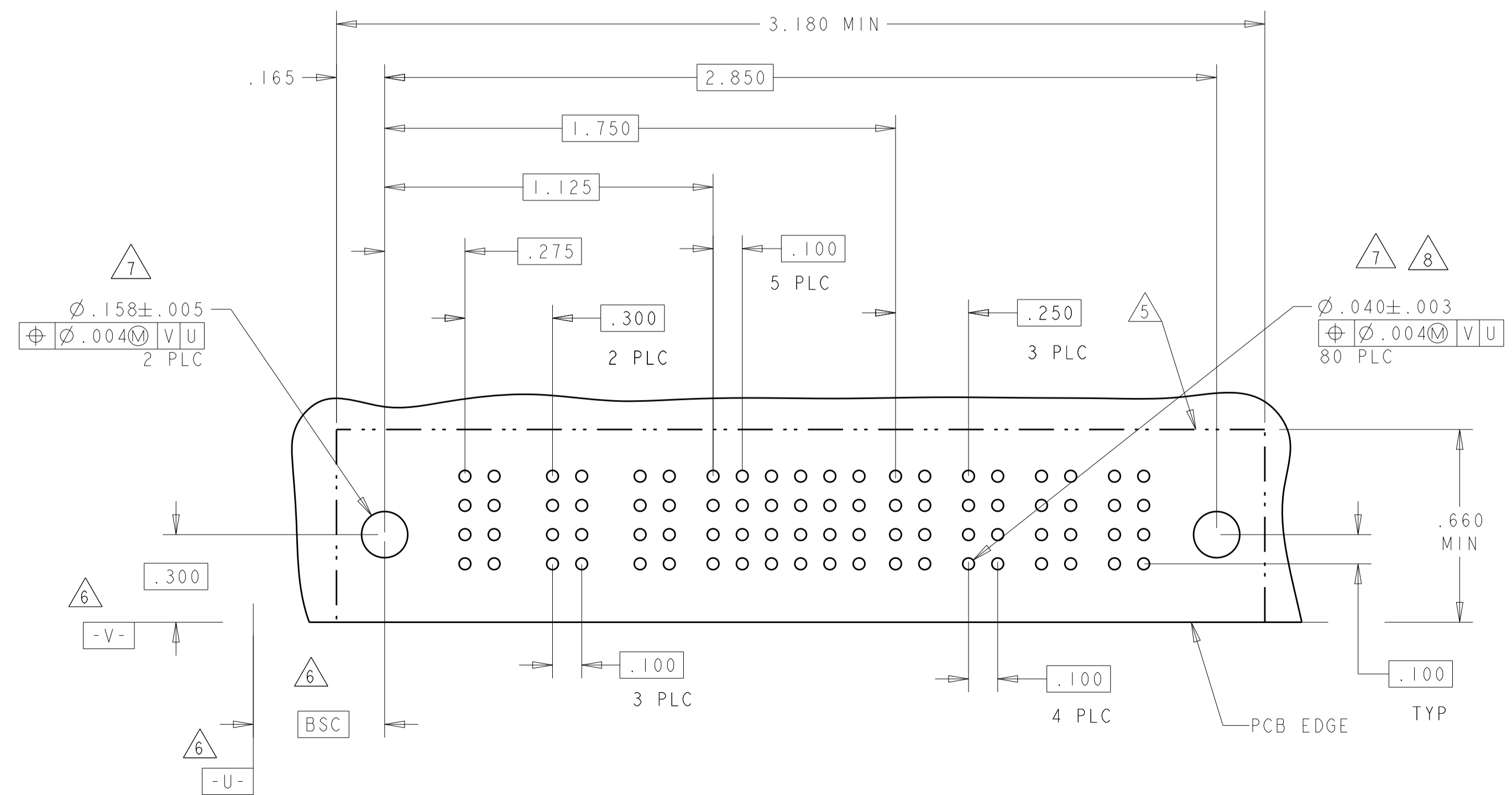

THIS DRAWING IS A CONTROLLED DOCUMENT.		OWN: R. GRZYBOWSKI 28FEB05	 TE Connectivity
DIMENSIONS: INCHES		CHK: M. PERCHERKE 28FEB05	
TOLERANCES UNLESS OTHERWISE SPECIFIED:		APVD: M. PERCHERKE	NAME: RIGHT ANGLE HEADER ASSEMBLY SOLDER TAILS, W/GUIDES MULTI-BEAM XL
0 PLC ±.01		PRODUCT SPEC: 108-1973	SIZE: 114-13038
1 PLC ±.01		APPLICATION SPEC:	RESTRICTED TO:
2 PLC ±.005		WEIGHT:	A100779C=6450330
3 PLC ±.002		FINISH:	SCALE: 4:1 SHEET 8 OF 20 REV: R3
4 PLC ±.002		CUSTOMER DRAWING	

PART NUMBER	ROWS	POWER			SIGNAL						POWER		
		P1	P2	P3	1	2	3	4	5	6	P4	P5	P6
3-6450330-9	D	PM	PM	PM	J	E	E	E	E	E	PM	PM	PM
	C				F	F	F	F	F	K			
	B				G	G	G	G	G	N			
	A				H	H	H	H	H	H			
3P + 24S + 3P													

PART NUMBER	ROWS	POWER			SIGNAL						POWER		
		P1	P2	P3	1	2	3	4	5	6	P4	P5	P6
7-6450330-0	D	PM	PM	PM	J	J	J	J	J	J	PM	PM	PM
	C				K	K	K	K	K	K			
	B				N	N	N	G	N	N			
	A				S	S	S	S	S	S			
3P + 24S + 3P													

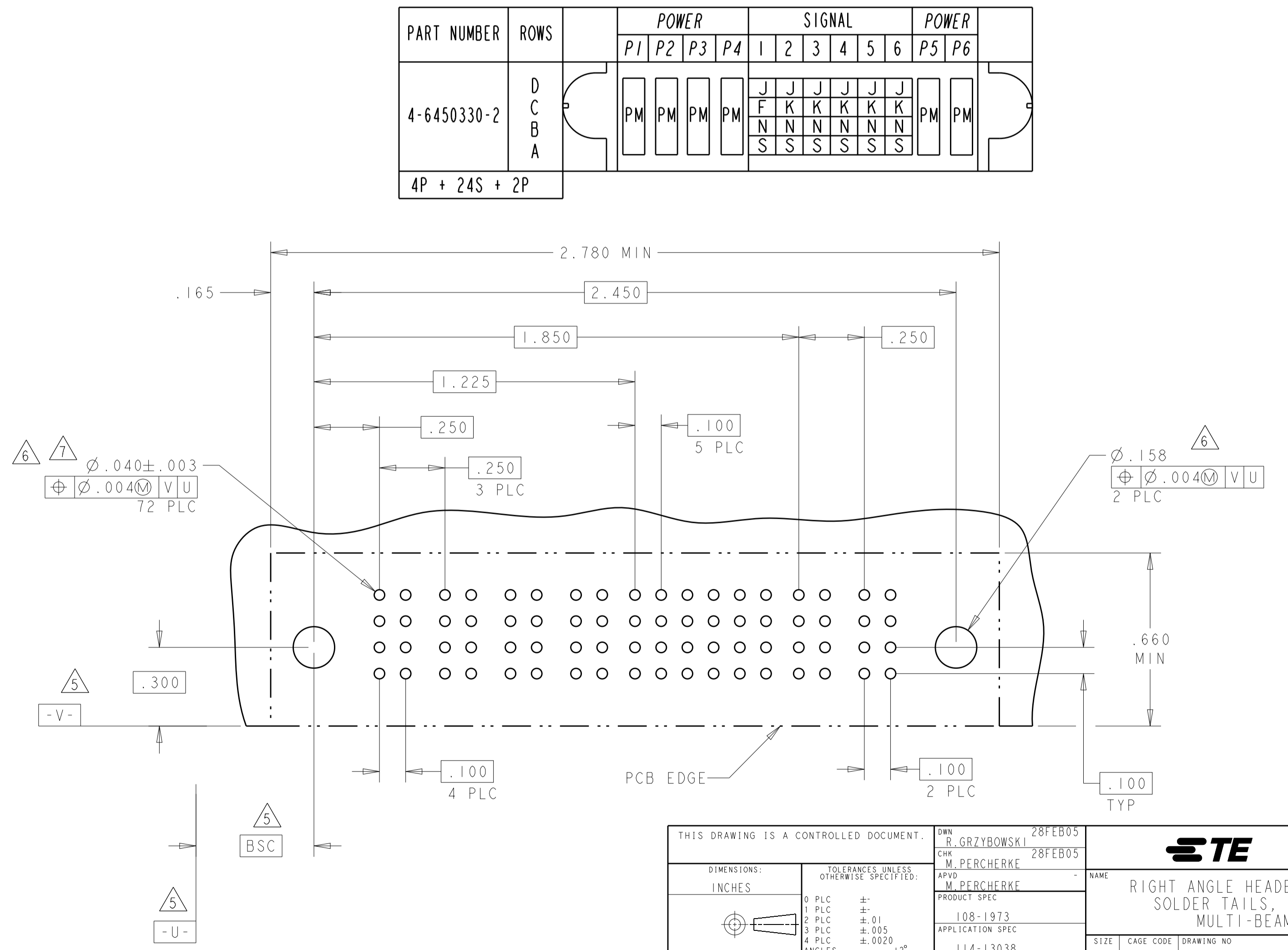
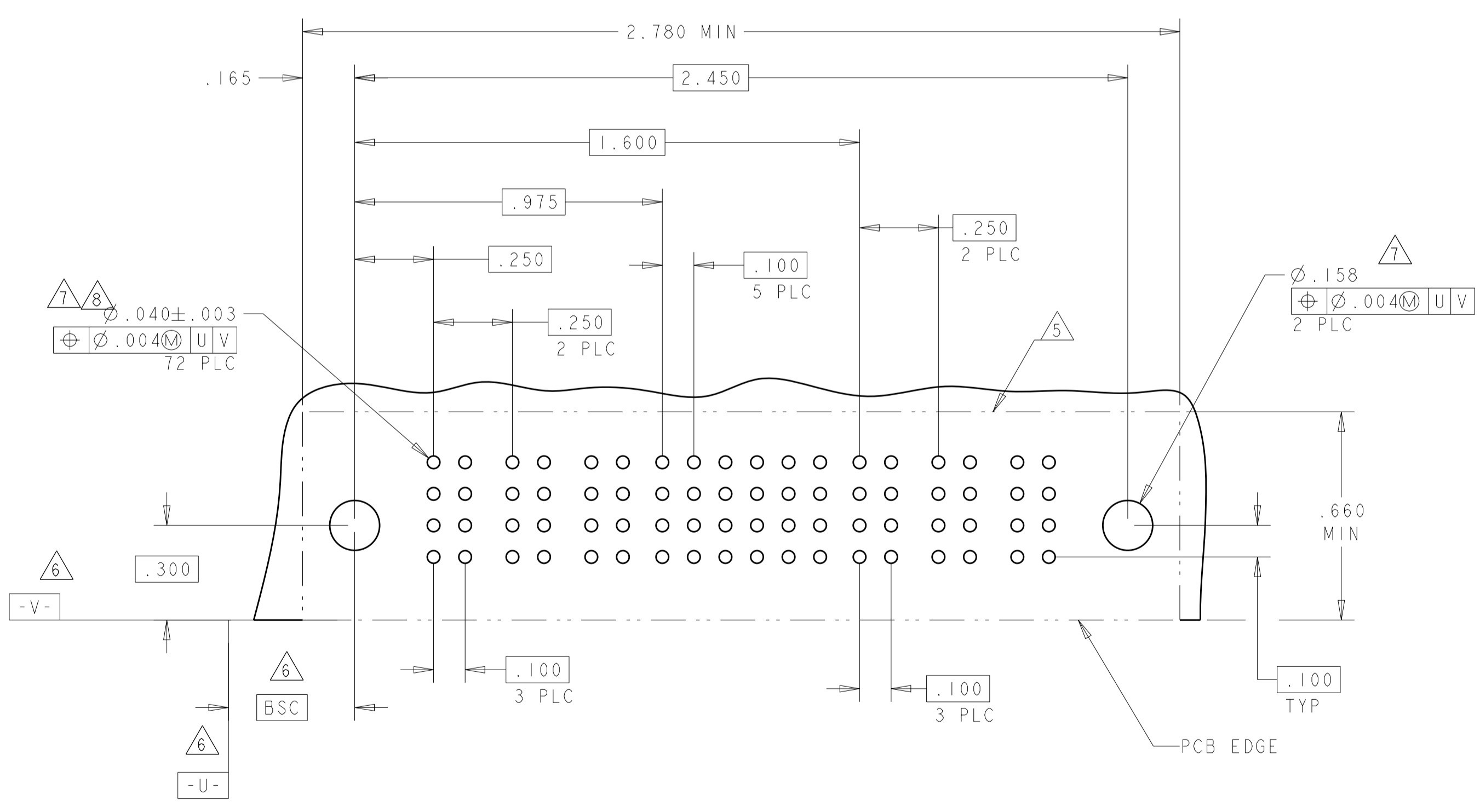

PART NUMBER	ROWS	POWER		SIGNAL				POWER	
		P1	P2	1	2	3	4	P3	P4
4-6450330-9	D	PM	PM	J	E	J	J	PM	PM
	C			K	F	K	K		
	B			N	G	N	N		
	A			S	H	S	S		
2P + 16S + 2P									

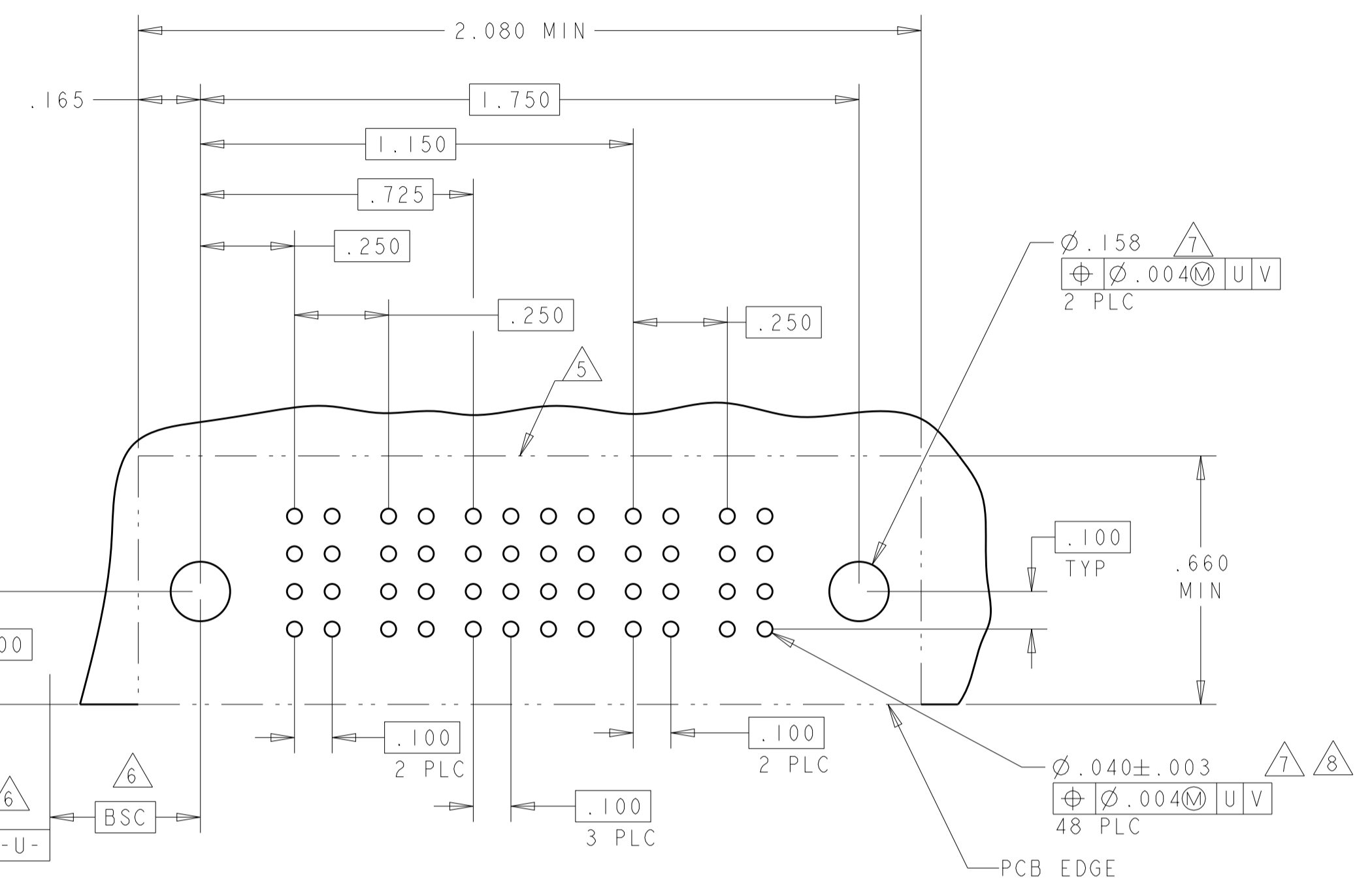

PART NUMBER	ROWS	POWER				SIGNAL						POWER	
		P1	P2	P3	P4	1	2	3	4	5	6	P5	P6
4-6450330-2	D	PM	PM	PM	PM	J	J	J	J	J	J	PM	PM
	C					F	K	K	K	K	K		
	B					N	N	N	N	N	N		
	A					S	S	S	S	S	S		
4P + 24S + 2P													

THIS DRAWING IS A CONTROLLED DOCUMENT.

DIMENSIONS: INCHES

TOLERANCES UNLESS OTHERWISE SPECIFIED:

0 PLC	±
1 PLC	±.01
2 PLC	±.01
3 PLC	±.005
4 PLC	±.002
ANGLES	±.0020

MATERIAL: FINISH: *

OWN: R. GRZYBOWSKI 28FEB05
CHK: M. PERCHERKE 28FEB05
APVD: M. PERCHERKE

NAME: RIGHT ANGLE HEADER ASSEMBLY SOLDER TAILS, W/GUIDES MULTI-BEAM XL

PRODUCT SPEC: 108-1973
APPLICATION SPEC: 114-13038

SIZE: A1
CAGE CODE: 100779
DRAWING NO: 6450330

WEIGHT: -
CUSTOMER DRAWING

SCALE: 4:1
SHEET: 9 of 20
REV: R3

LOC	DIST	REV	DATE	OWN	APVD
ES	00				

REV	DATE	OWN	APVD
1			

PART NUMBER	ROWS	POWER				SIGNAL						POWER		
		P1	P2	P3	P4	1	2	3	4	5	6	P5	P6	P7
5-6450330-0	D C B A	PM	PM	PM	PM	J	J	J	J	J	J	PM	PM	PM
						K	K	K	K	K	K			
						N	N	N	N	N	N			
						S	S	S	S	S	H			
4P + 24S + 3ACP														

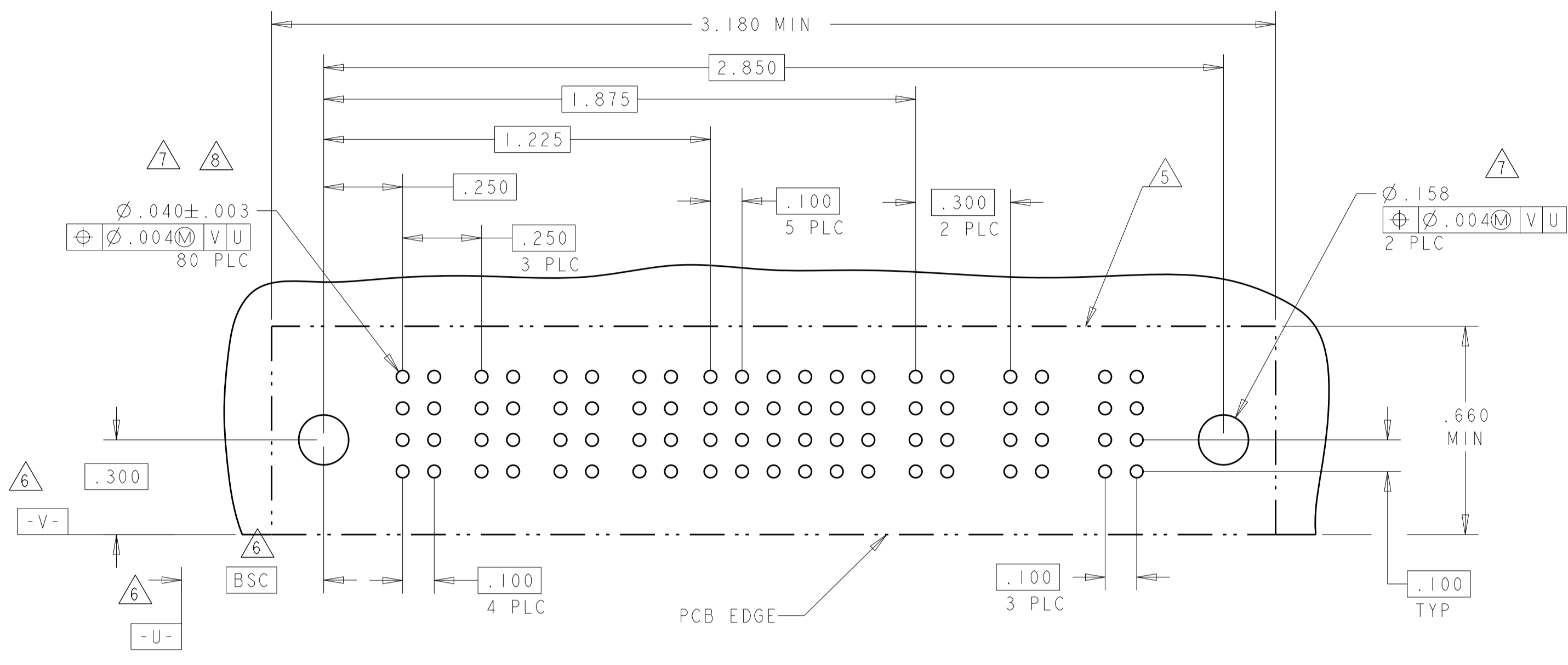

PART NUMBER	ROWS	POWER		SIGNAL				POWER	
		P1	P2	1	2	3	4	P3	P4
5-6450330-1	D C B A	PM	PM	J	J	J	E	PM	PM
				K	K	K	K		
				N	G	N	N		
				S	S	S	S		
2P + 16S + 2P									

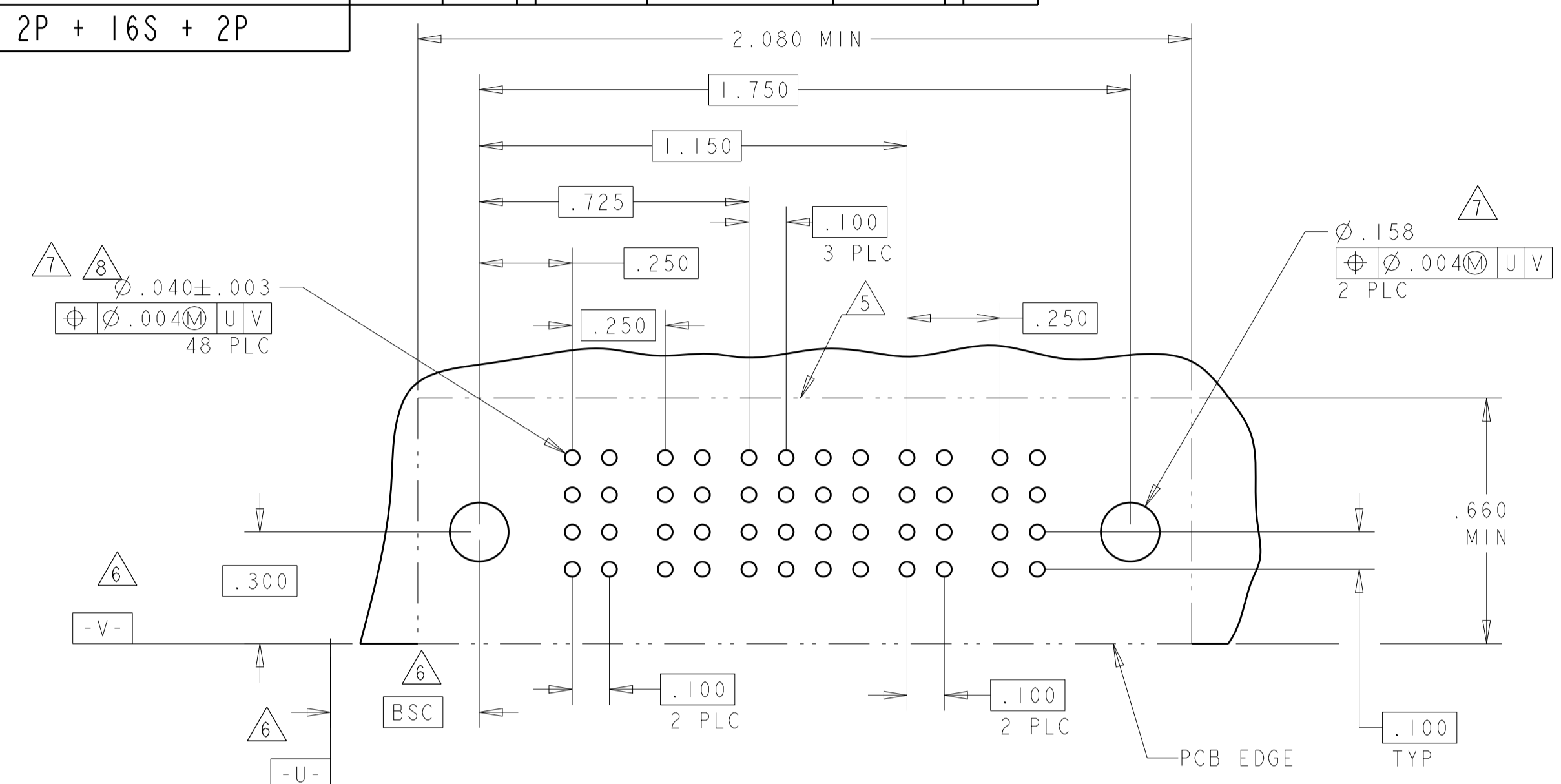

PART NUMBER	ROWS	POWER			SIGNAL						POWER		
		P1	P2	P3	1	2	3	4	5	6	P4	P5	P6
2-6450330-6	D C B A	PM	PM	PM	J	J	E	J	J	J	PM	PM	PM
					K	K	K	K	K	K			
					N	N	N	N	N	N			
					S	S	S	S	S	S			
3ACP + 24S + 3ACP													

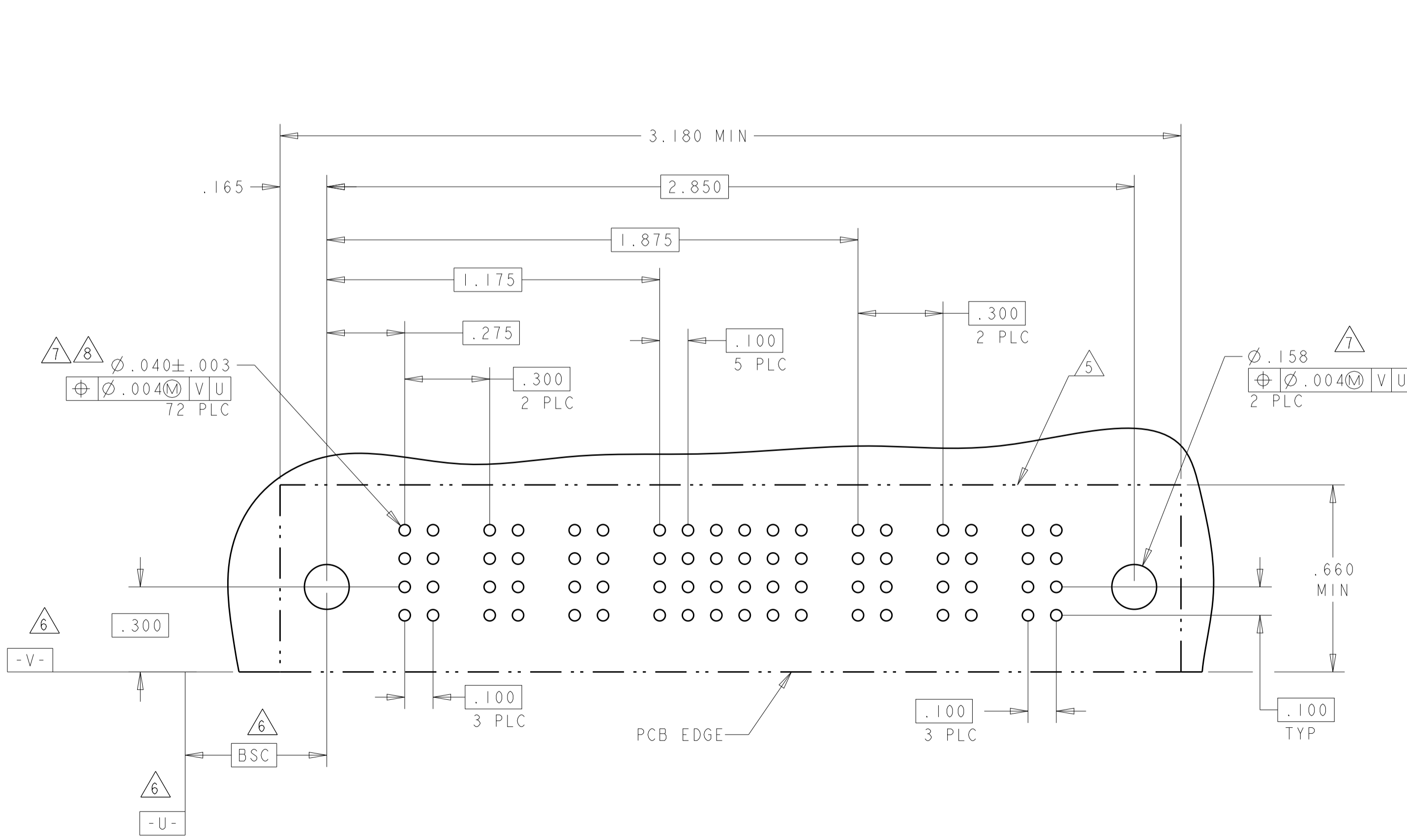

PART NUMBER	ROWS	POWER				SIGNAL						POWER			
		P1	P2	P3	P4	1	2	3	4	5	6	P5	P6	P7	P8
5-6450330-3	D C B A	PM	PM	PM	PM	J	J	J	J	J	J	PM	PM	PM	PM
						K	K	K	K	K	K				
						N	N	N	N	N	N				
						S	S	S	S	S	H				
4P + 24S + 4P															

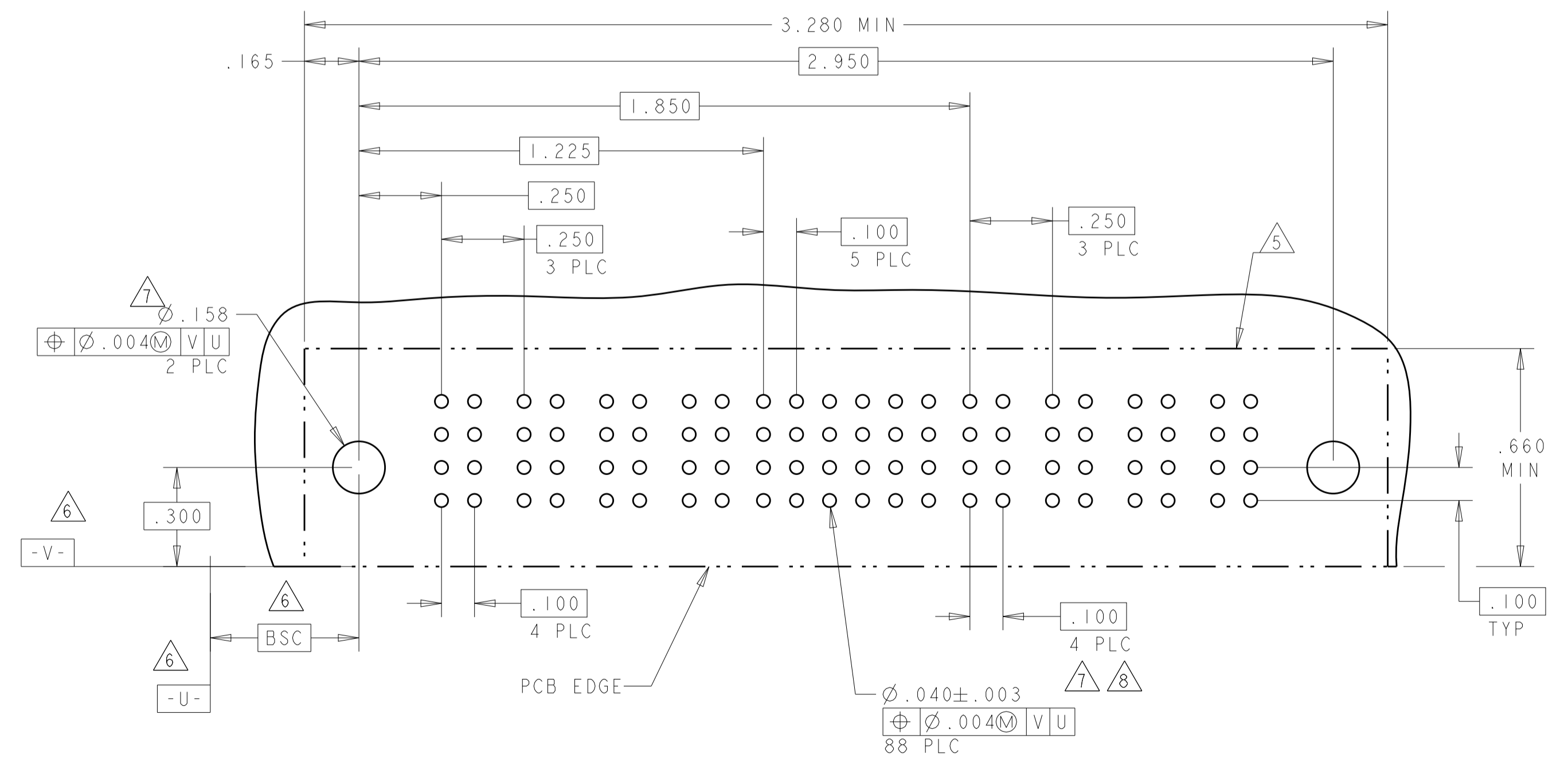

THIS DRAWING IS A CONTROLLED DOCUMENT.

DIMENSIONS: INCHES	TOLERANCES UNLESS OTHERWISE SPECIFIED:	0 PLC	±
		1 PLC	±.01
MATERIAL	FINISH	2 PLC	±.005
		3 PLC	±.0020
		4 PLC	±.0020
		ANGLES	90°

OWN: R. GRZYBOWSKI	28FEB05	 TE Connectivity
CHK: M. PERCHERKE	28FEB05	
APVD: M. PERCHERKE		NAME
PRODUCT SPEC		RIGHT ANGLE HEADER ASSEMBLY
APPLICATION SPEC		SOLDER TAILS, W/GUIDES
108-1973		MULTI-BEAM XL
114-13038		SIZE
WEIGHT		CAGE CODE
		DRAWING NO
		RESTRICTED TO
CUSTOMER DRAWING		A100779
		SCALE
		4:1
		SHEET
		10
		OF
		20
		REV
		R3

LOC		DIST		REVISIONS			
ES	00	P	LTN	DESCRIPTION	DATE	DMN	APVD
		-		SEE SHEET 1	-	-	-

PART NUMBER	ROWS	POWER			SIGNAL						POWER		
		P1	P2	P3	1	2	3	4	5	6	P4	P5	P6
5-6450330-2	D	PM	PM	PM	J	J	J	J	J	J	PM	PM	PM
	C				K	K	K	K	K	K			
	B				N	N	G	N	N	N			
	A				S	S	S	S	S	S			
3P + 24S + 3P													

PART NUMBER	ROWS	SIGNAL			
		1	2	3	4
3-6450330-1	D	E	E	E	E
	C	F	F	F	K
	B	G	G	G	G
	A	H	H	H	H
16S					

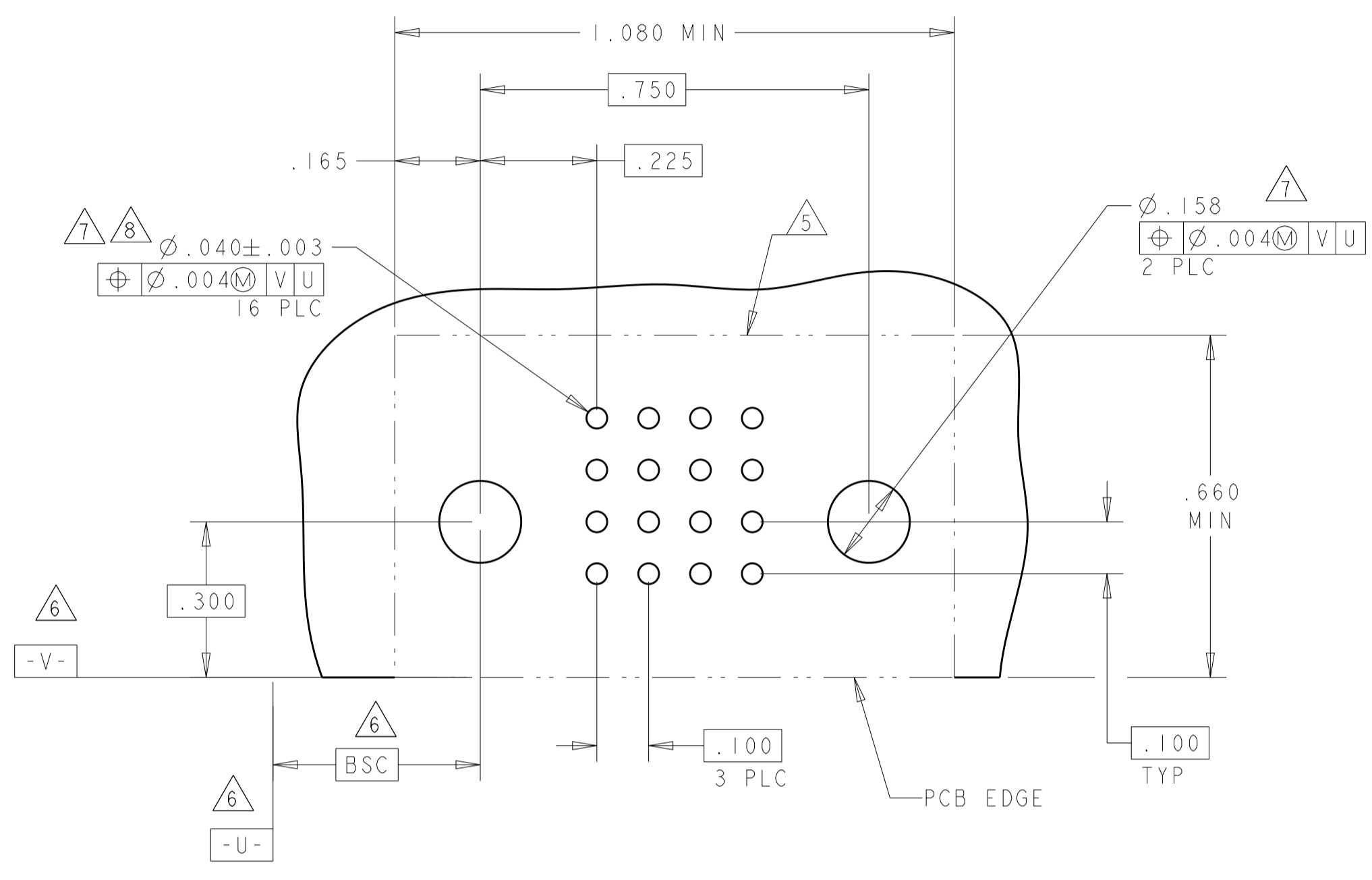
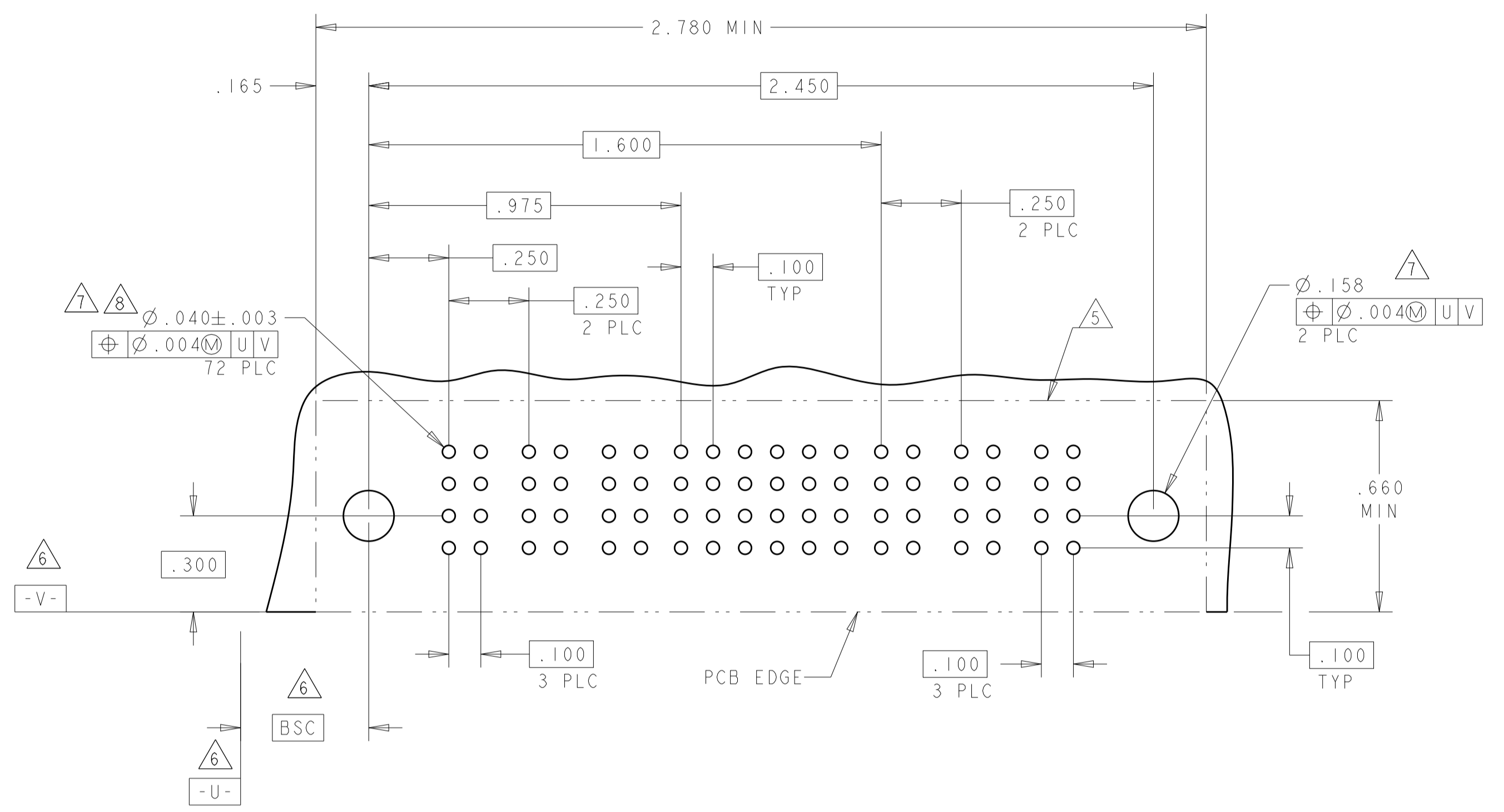

PART NUMBER	ROWS	POWER						SIGNAL		POWER							
		P1	P2	P3	P4	P5	P6	P7	1	2	P8	P9	P10	P11	P12	P13	P14
5-6450330-4	D	PM	PM	PM	PM	PM	PM	J	J	PM	PM	PM	PM	PM	PM	PM	
	C							K	K								
	B							N	N								
	A							H	S								
7P + 8S + 7P																	

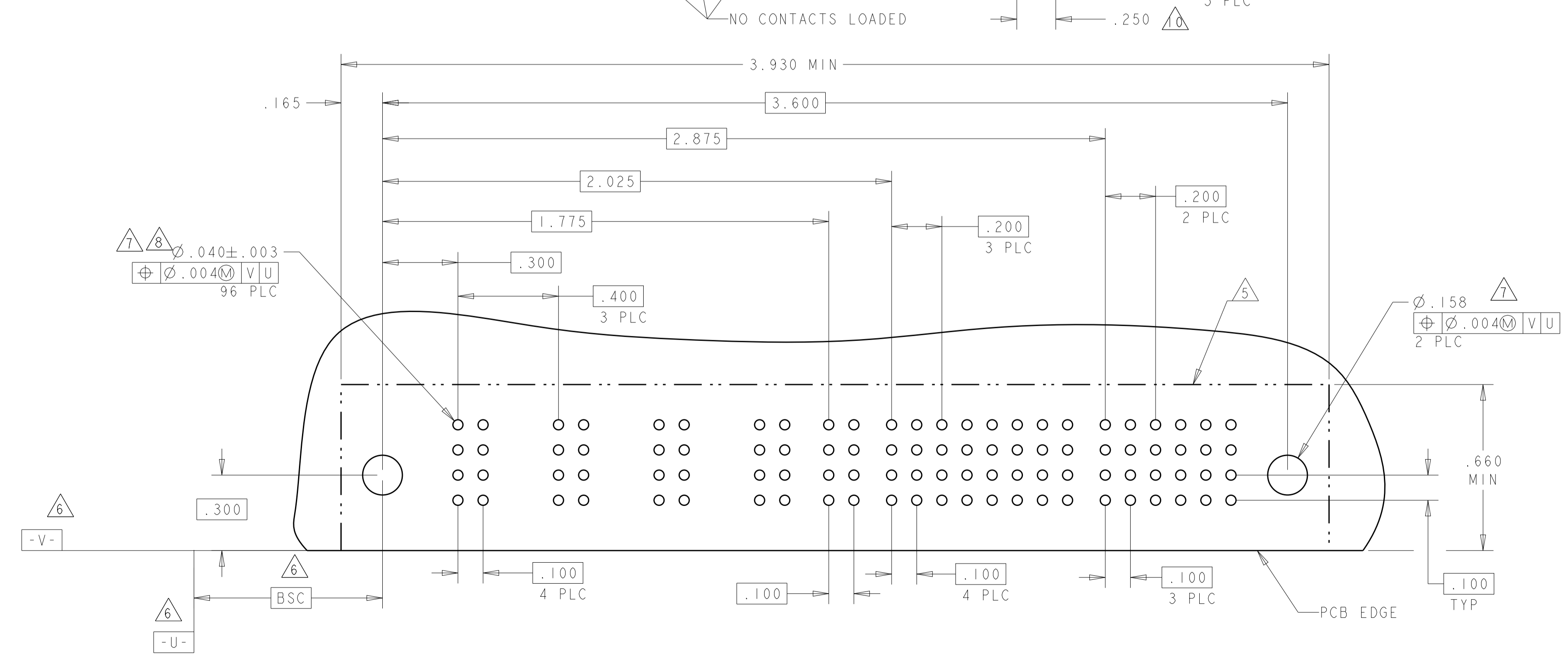

THIS DRAWING IS A CONTROLLED DOCUMENT.		DMN: R.GRZYBOWSKI 28FEB05	TE Connectivity
DIMENSIONS: INCHES		CHK: M.PERCHEKKE 28FEB05	
TOLERANCES UNLESS OTHERWISE SPECIFIED:		APVD: M.PERCHEKKE	NAME: RIGHT ANGLE HEADER ASSEMBLY SOLDER TAILS, W/GUIDES MULTI-BEAM XL
0 PLC ± .01 1 PLC ± .01 2 PLC ± .01 3 PLC ± .005 4 PLC ± .002 ANGLES ± .020		PRODUCT SPEC: 108-1973	SIZE: CAGE CODE DRAWING NO: A100779 C=6450330
MATERIAL: FINISH: *		APPLICATION SPEC: 114-13038	RESTRICTED TO: -
		WEIGHT: -	SCALE: 4:1 SHEET 11 OF 20 REV: R3
		CUSTOMER DRAWING	

LOC	DIST	REVISIONS			
P	LTN	DESCRIPTION	DATE	OWN	APVD
ES	00	SEE SHEET 1			

PART NUMBER	ROWS	POWER		SIGNAL				POWER	
		P1	P2	1	2	3	4	P1	P2
5-6450330-5	D	PM	PM	J	J	J	J	PM	PM
	C			K	K	F	K		
	B			N	N	G	N		
	A			S	S	S	S		
IP + 16S + IP									

PART NUMBER	ROWS	POWER		SIGNAL				POWER	
		P1	P2	1	2	3	4	P1	P2
6-6450330-9	D	PM	PM	J	J	J	J	PM	PM
	C			K	K	K	K		
	B			N	N	N	N		
	A			S	S	S	S		
IP + 16S + IP									

PART NUMBER	ROWS	POWER		SIGNAL				POWER	
		P1	P2	1	2	3	4	P3	P4
5-6450330-6	D	PA	PA	A4	A4	A4	Z	PA	PA
	C			A3	A3	A3	Y		
	B			A2	A2	A2	R		
	A			A1	A1	A1	O		
2P + 16S + 2P									

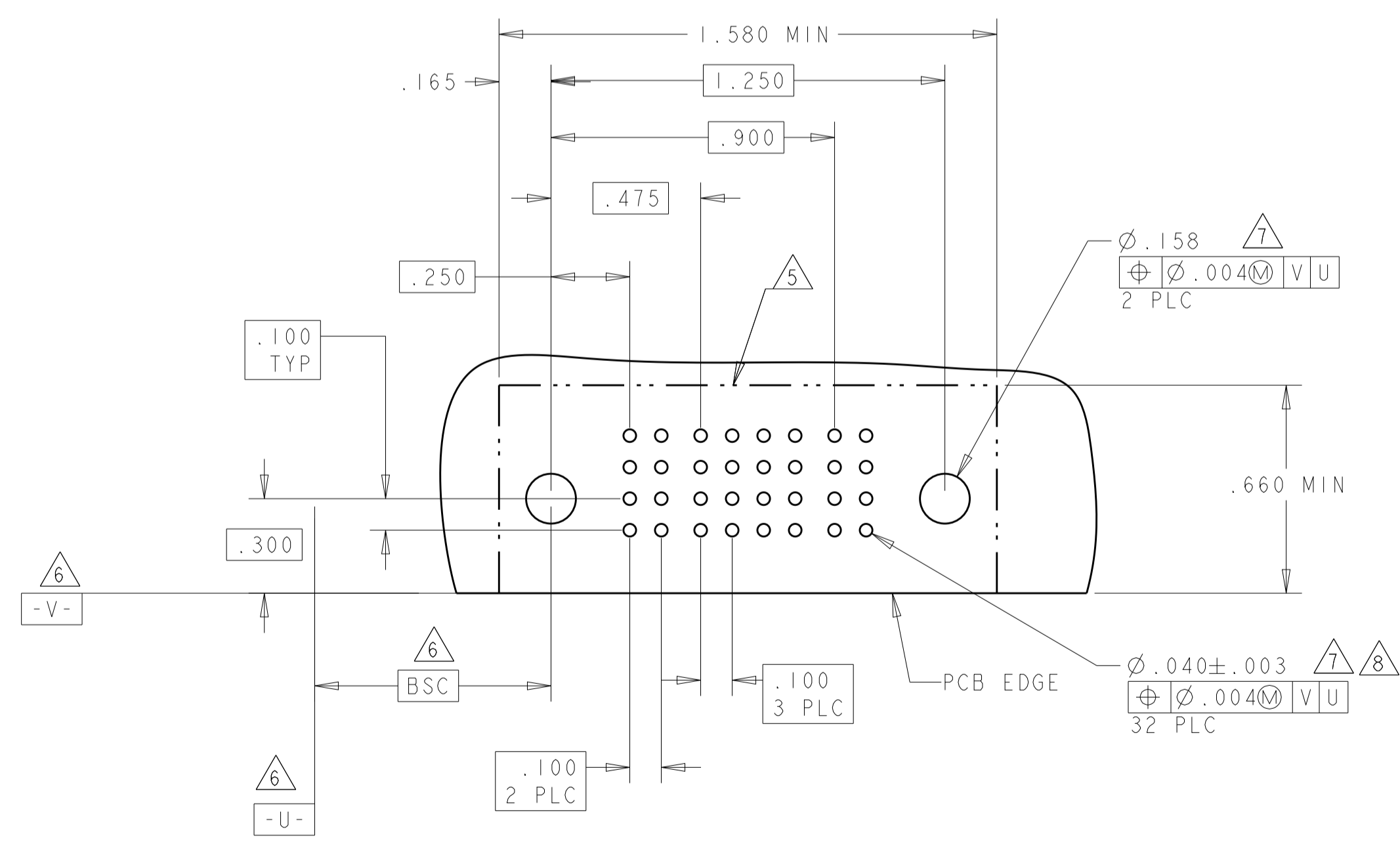

PCB LAYOUT VIEW FOR P/N: 5-6450330-5 AND 6-6450330-9

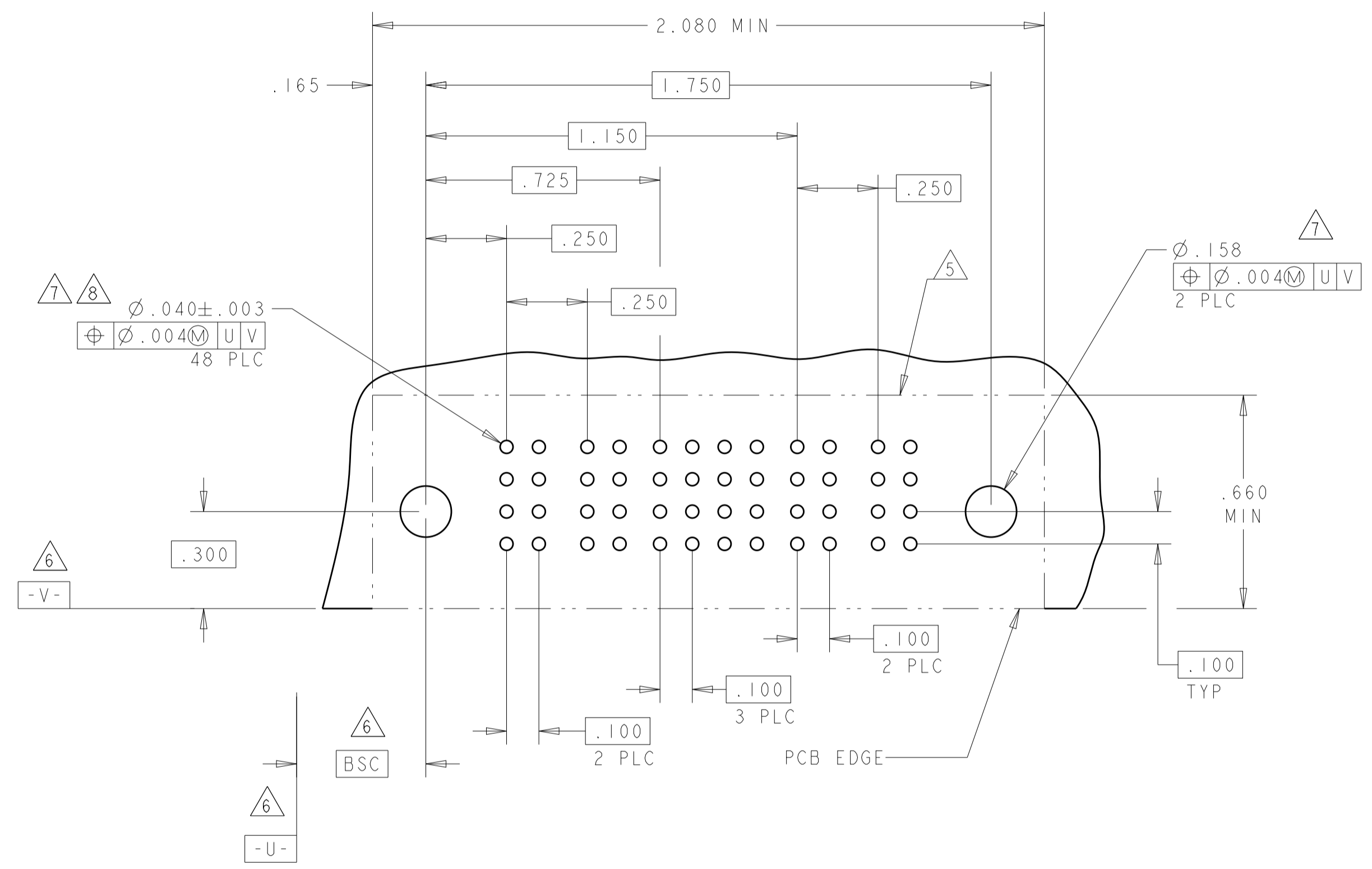

THIS DRAWING IS A CONTROLLED DOCUMENT.		OWN: R. GRZYBOWSKI 28FEB05	TE Connectivity
DIMENSIONS: INCHES		CHK: M. PERCHERKE 28FEB05	
DIMENSIONS: INCHES 0 PLC ±. 1 PLC ±.01 2 PLC ±.01 3 PLC ±.005 4 PLC ±.002 ANGLES ±.020		NAME: M. PERCHERKE PRODUCT SPEC: 108-1973 APPLICATION SPEC: 114-13038 WEIGHT:	
MATERIAL: FINISH:		SIZE: A1 CAGE CODE: 6450330 CUSTOMER DRAWING:	
		SCALE: 4:1 SHEET 12 OF 20 REV: R3	

LOC	DIST	REVISIONS					
		P	LTN	DESCRIPTION	DATE	DMN	APVD
ES	00	-	-	SEE SHEET 1	-	-	-

PART NUMBER	ROWS	POWER		SIGNAL												POWER	
		P1	P2	1	2	3	4	5	6	7	8	9	10	11	12	P3	P4
5-6450330-7	D	PM	PM	J	J	E	E	J	E	E	J	E	E	J	J	PM	PM
	C			F	F	K	F	F	F	K	F	F	F	F			
	B			N	N	G	G	G	G	G	N	G	G	G			
	A			H	H	S	H	H	H	S	H	H	H	H			
2P + 48S + 2P																	

PART NUMBER	ROWS	POWER						SIGNAL						POWER					
		P1	P2	P3	P4	P5	P6	1	2	3	4	5	6	P7	P8	P9	P10	P11	P12
5-6450330-8	D	PM	PM	PM	PM	PM	PM	J	J	E	E	J	J	PM	PM	PM	PM	PM	PM
	C							F	F	K	F	F	F						
	B							N	N	G	G	G	G						
	A							H	H	S	H	H	H						
6ACP + 24S + 6ACP																			

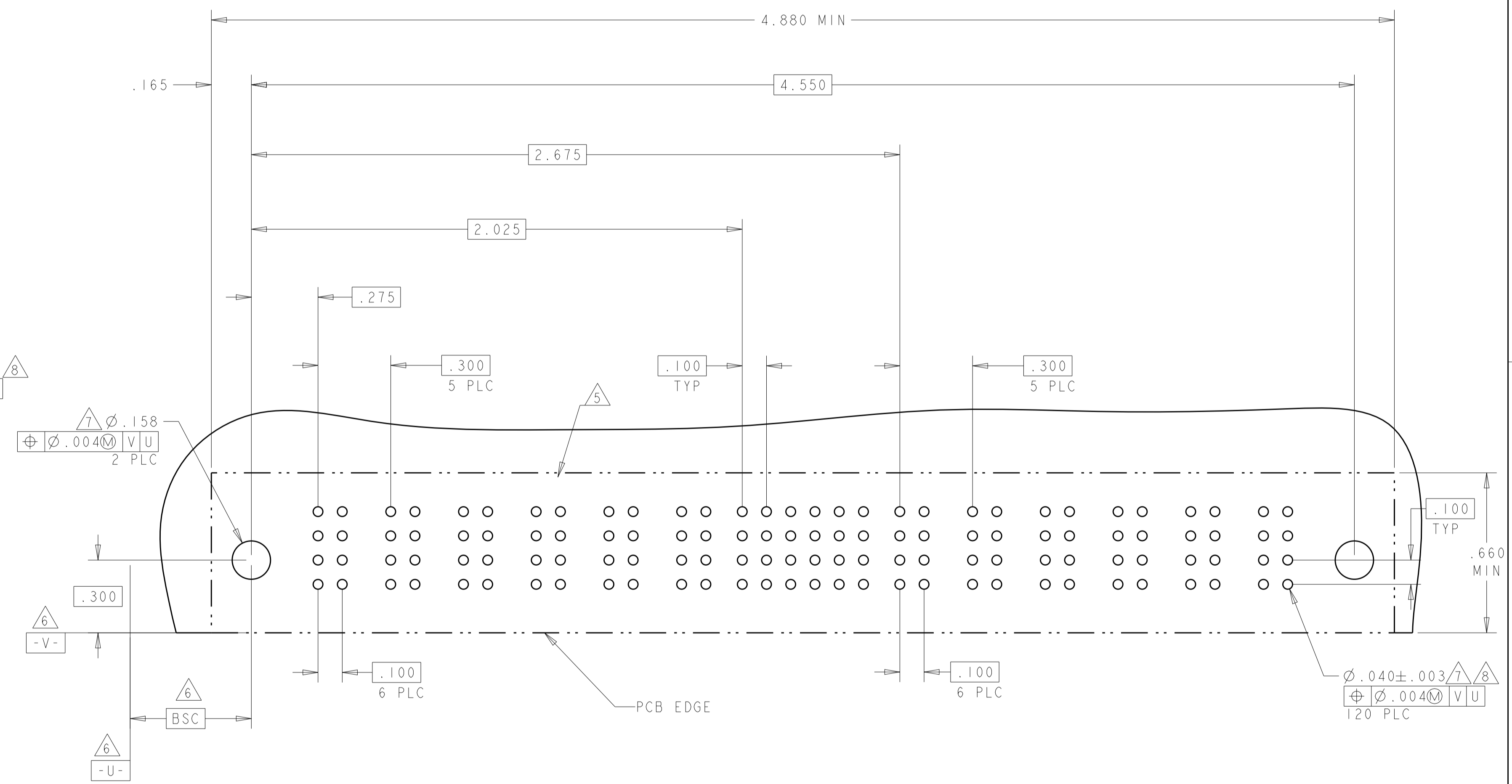
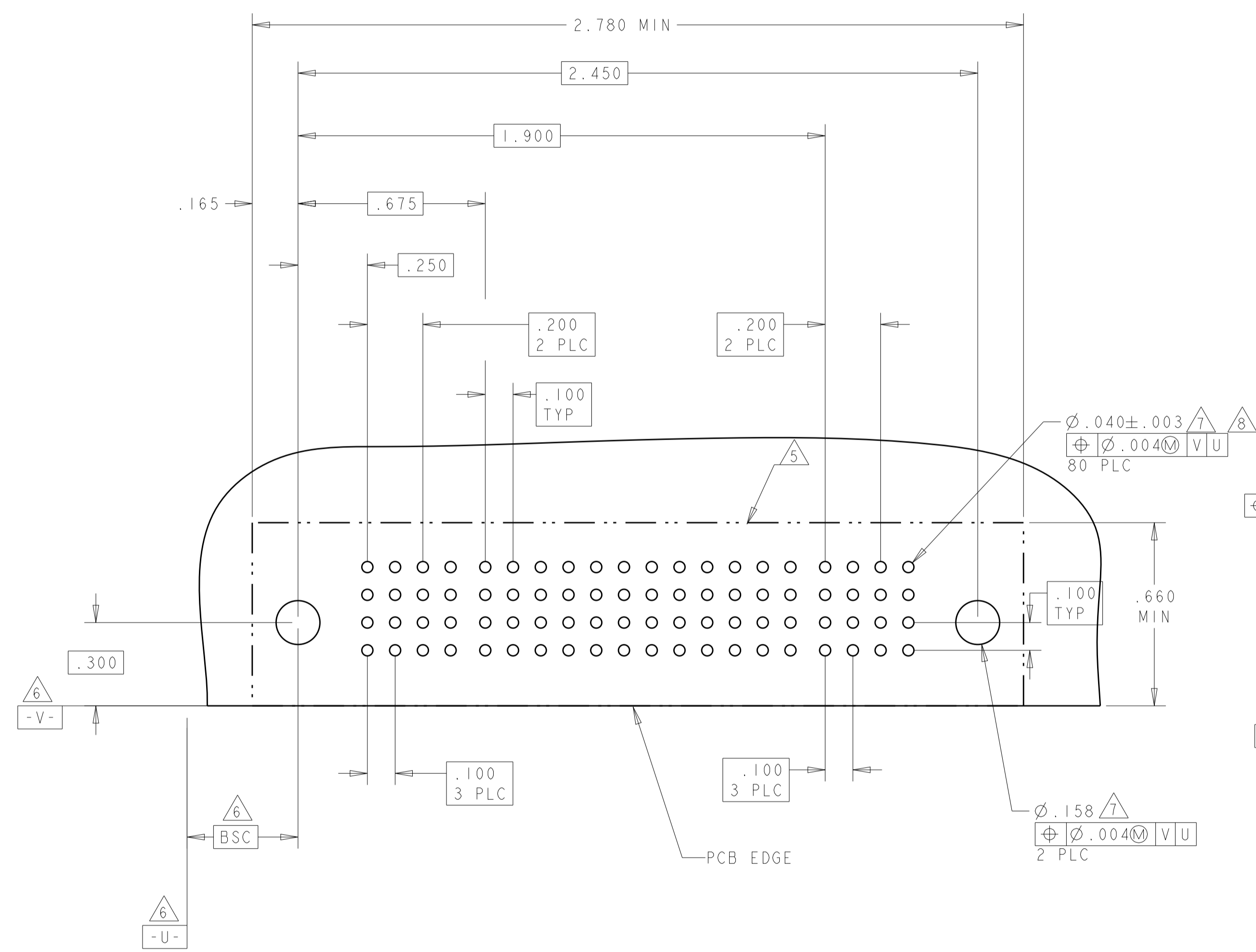

THIS DRAWING IS A CONTROLLED DOCUMENT.

DIMENSIONS: INCHES	TOLERANCES UNLESS OTHERWISE SPECIFIED: 0 PLC ±. 1 PLC ±.01 2 PLC ±.01 3 PLC ±.005 4 PLC ±.002 ANGLES ±.7°	DMN: R. GRZYBOWSKI 28FEB05 CHK: M. PERCHERKE 28FEB05 APVD: M. PERCHERKE	NAME: RIGHT ANGLE HEADER ASSEMBLY SOLDER TAILS, W/GUIDES MULTI-BEAM XL
MATERIAL:	FINISH:	PRODUCT SPEC: 108-1973 APPLICATION SPEC: 114-13038 WEIGHT: -	SIZE: A1 CAGE CODE: 100779 DRAWING NO: 6450330
CUSTOMER DRAWING		SCALE: 4:1	SHEET 13 OF 20 REV: R3

4805 (3/11)

LOC	DIST	REV	DATE	BY	APPV
ES	00				
		DESCRIPTION		DATE	BY
		SEE SHEET 1			

PART NUMBER	ROWS	POWER				SIGNAL						POWER			
		P1	P2	P3	P4	1	2	3	4	5	6	P5	P6	P7	P8
3-6450330-7	D	PM	PM	PM	PM	J	J	J	J	J	J	PM	PM	PM	PM
	C					K	K	K	K	K	K				
	B					N	N	N	N	N	N				
	A					H	S	S	S	S	S				
4P + 24S + 4P															

PART NUMBER	ROWS	POWER						SIGNAL		POWER	
		P1	P2	P3	P4	P5	P6	1	2	P7	P8
5-6450330-9	D	PM	PM	PM	PM	PM	PM	J	J	PM	PM
	C							K	K		
	B							N	N		
	A							FS	S		
6P + 8S + 2P											

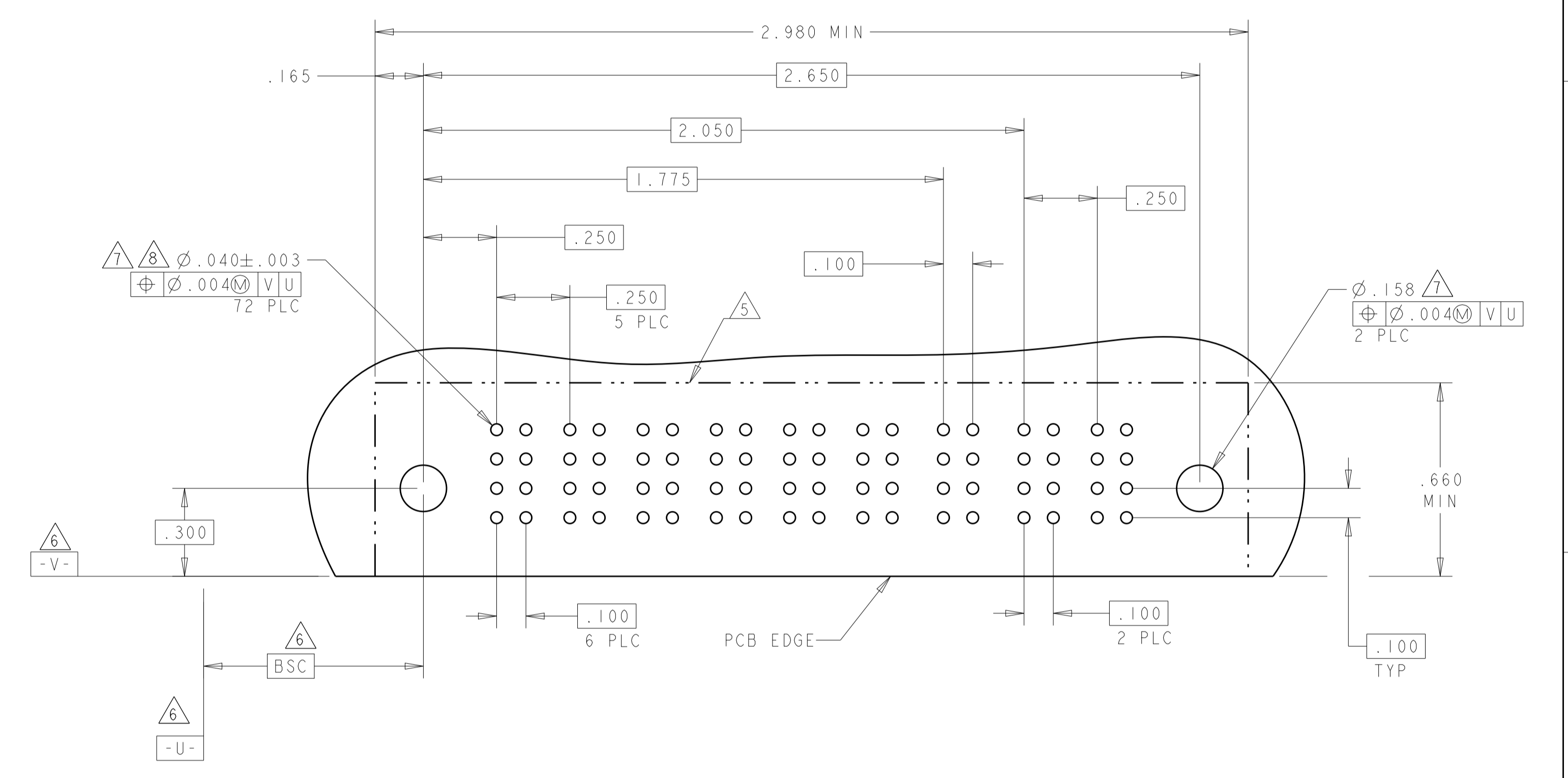
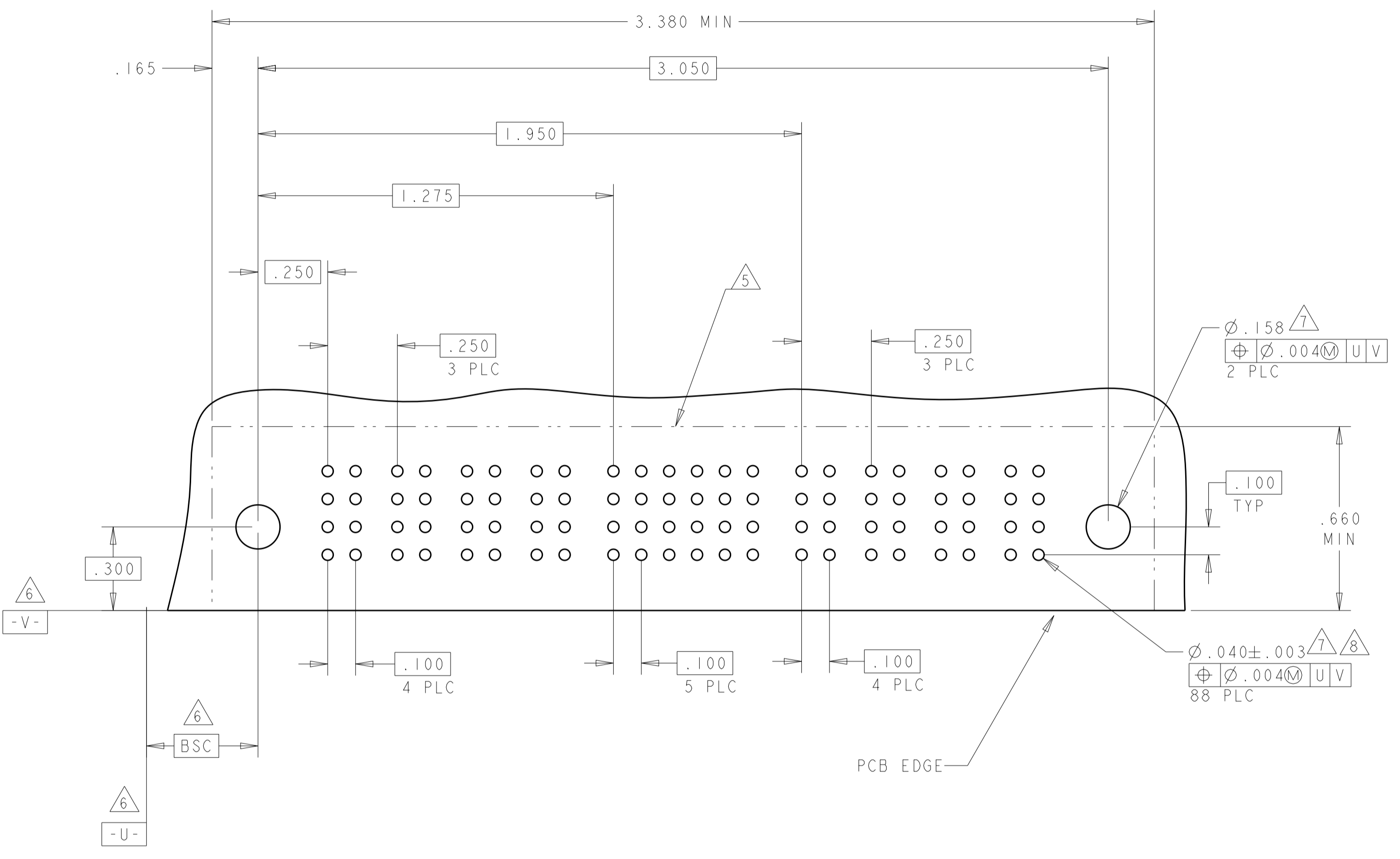

THIS DRAWING IS A CONTROLLED DOCUMENT.		DWN: R. GRZYBOWSKI / 28FEB05 CHK: M. PERCHERKE / 28FEB05 APVD: M. PERCHERKE	STE TE Connectivity		
DIMENSIONS: INCHES 		TOLERANCES UNLESS OTHERWISE SPECIFIED: 0 PLC ±. 1 PLC ±.01 2 PLC ±.01 3 PLC ±.005 4 PLC ±.002 ANGLES ±.020		NAME: RIGHT ANGLE HEADER ASSEMBLY PRODUCT SPEC: 108-1973 APPLICATION SPEC: 114-13038 WEIGHT: - CUSTOMER DRAWING	
MATERIAL: - FINISH: -		SIZE: A1 CAGE CODE: 6450330 SCALE: 4:1 SHEET: 14 OF 20 REV: R3		RESTRICTED TO: -	

LOC	DIST	REVISIONS			
P	LTN	DESCRIPTION	DATE	DWN	APVD
-	-	SEE SHEET 1	-	-	-

PART NUMBER	ROWS	POWER												SIGNAL												POWER								
		P1	P2	P3	P4	P5	P6	P7	P8	P9	P10	P11	P12	1	2	3	4	5	6	7	8	9	10	11	12	P13	P14	P15	P16	P17	P18	P19	P20	
6-6450330-0	D C B A	PM		PM		PM		PM		PM		PM		J	J	J								E	E	E	PM	PM		PM	PM			
														K	K	K								F	F	F								
														N	N	N								G	G	G								
														S	S	H								H	S	S								
12P + 48S + 8P																																		

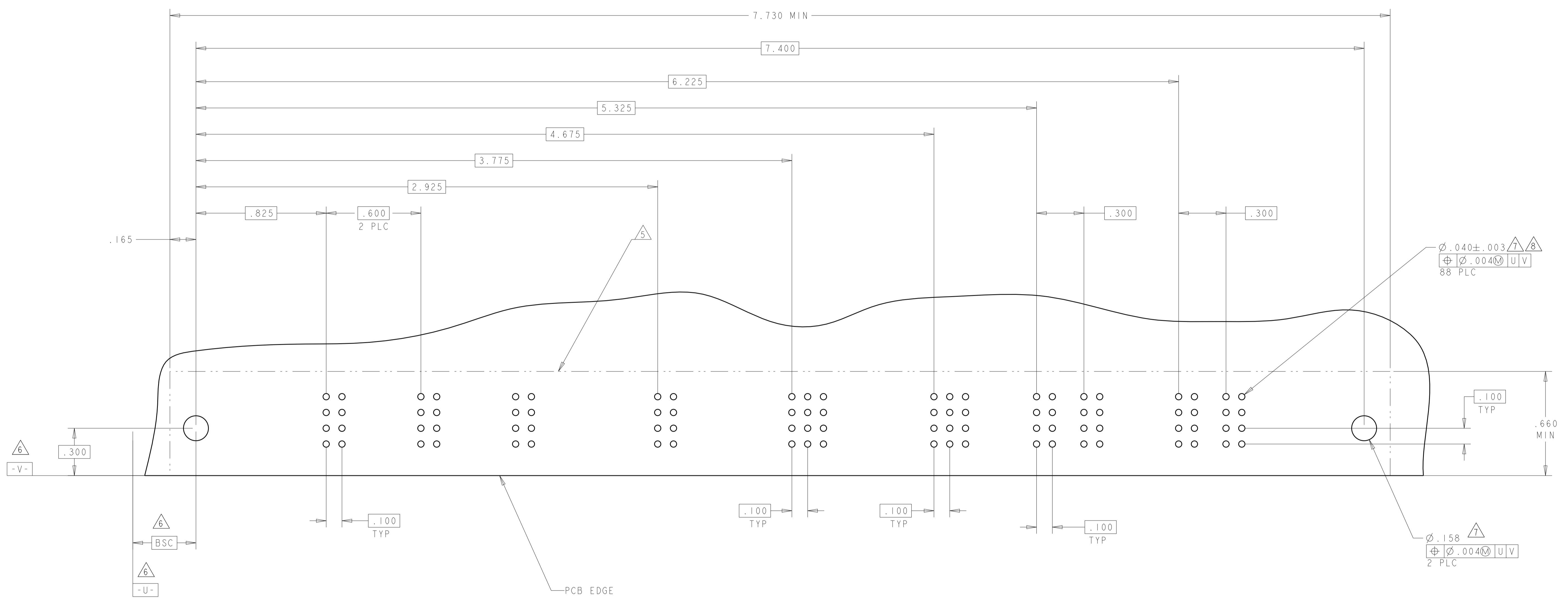

THIS DRAWING IS A CONTROLLED DOCUMENT.		DWN R. GRZYBOWSKI 28FEB05	28FEB05		TE Connectivity
DIMENSIONS: INCHES		CHK M. PERCHERKE 28FEB05			NAME RIGHT ANGLE HEADER ASSEMBLY SOLDER TAILS, W/GUIDES MULTI-BEAM XL
TOLERANCES UNLESS OTHERWISE SPECIFIED:		APVD M. PERCHERKE		PRODUCT SPEC	
0 PLC ±				108-1973	
1 PLC ±.01				APPLICATION SPEC	
2 PLC ±.005				114-13038	
3 PLC ±.002				WEIGHT	
4 PLC ±.0020				A100779C=6450330	
ANGLES ±.2°				CUSTOMER DRAWING	
FINISH				SCALE 4:1 SHEET 15 OF 20 REV R3	

LOC	DIST	REV	DATE	BY	APPD
ES	00				

REVISIONS			
REV	DATE	BY	APPD
-	-	-	-
-	-	-	-

PART NUMBER	ROWS	POWER		SIGNAL						POWER			
		P1	P2	1	2	3	4	5	6	P3	P4	P5	P6
3-6450330-5	D	PM	PM	J	J	J	E	J	J	PM	PM	PM	PM
	C			K	K	K	K	K					
	B			N	N	N	G	N	N				
	A			S	S	S	S	S	S				
2P + 24S + 4P													

(N6)

PART NUMBER	ROWS	POWER			SIGNAL				POWER			
		P1	P2	P3	1	2	3	4	P4	P5	P6	
6-6450330-1	D	PM	PM	PM	J	J	J	J	PM	PM	PM	PM
	C				K	K	K	F				
	B				G	N	N	N				
	A				S	S	S	S				
3P + 16S + 3P												

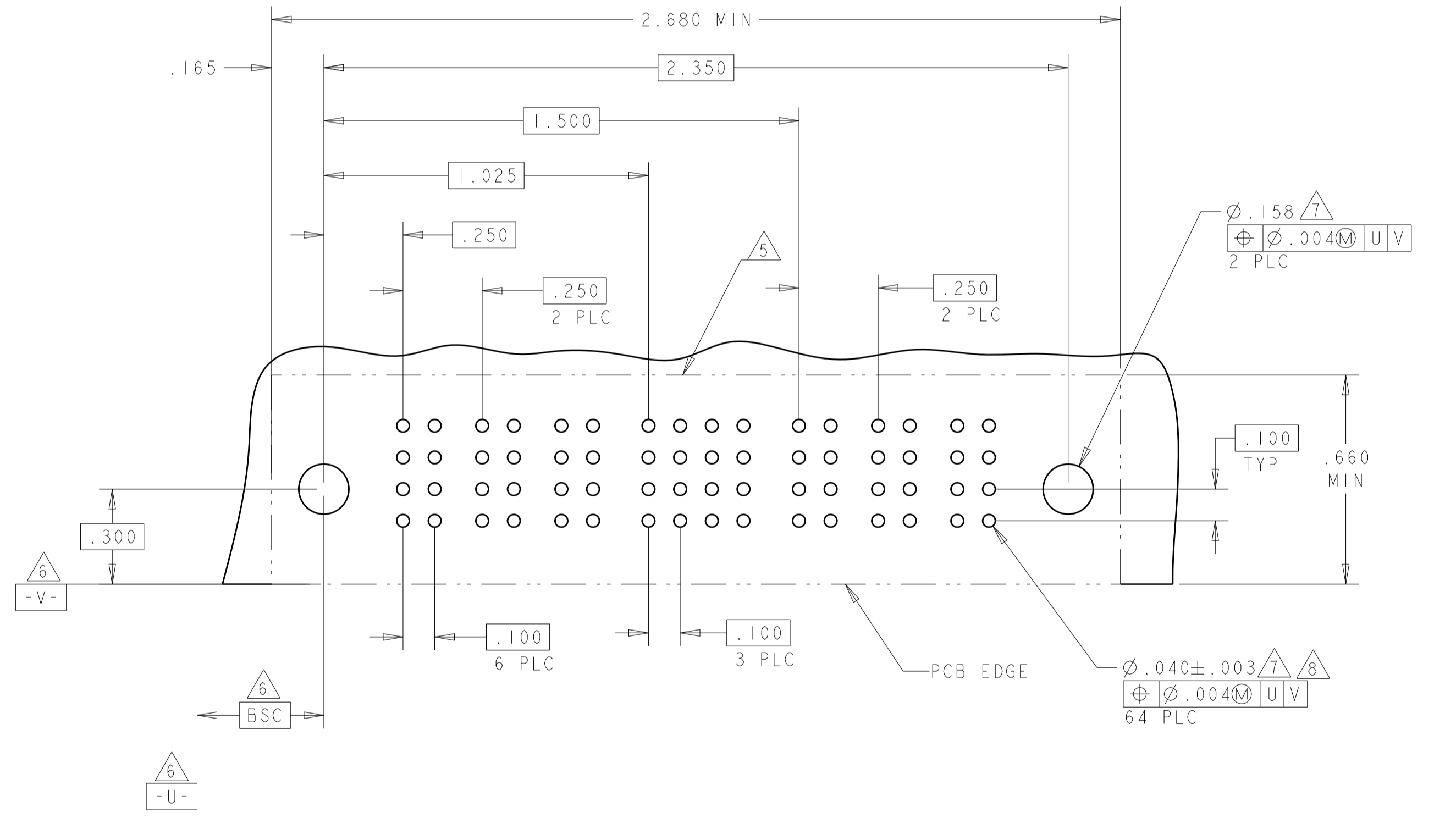
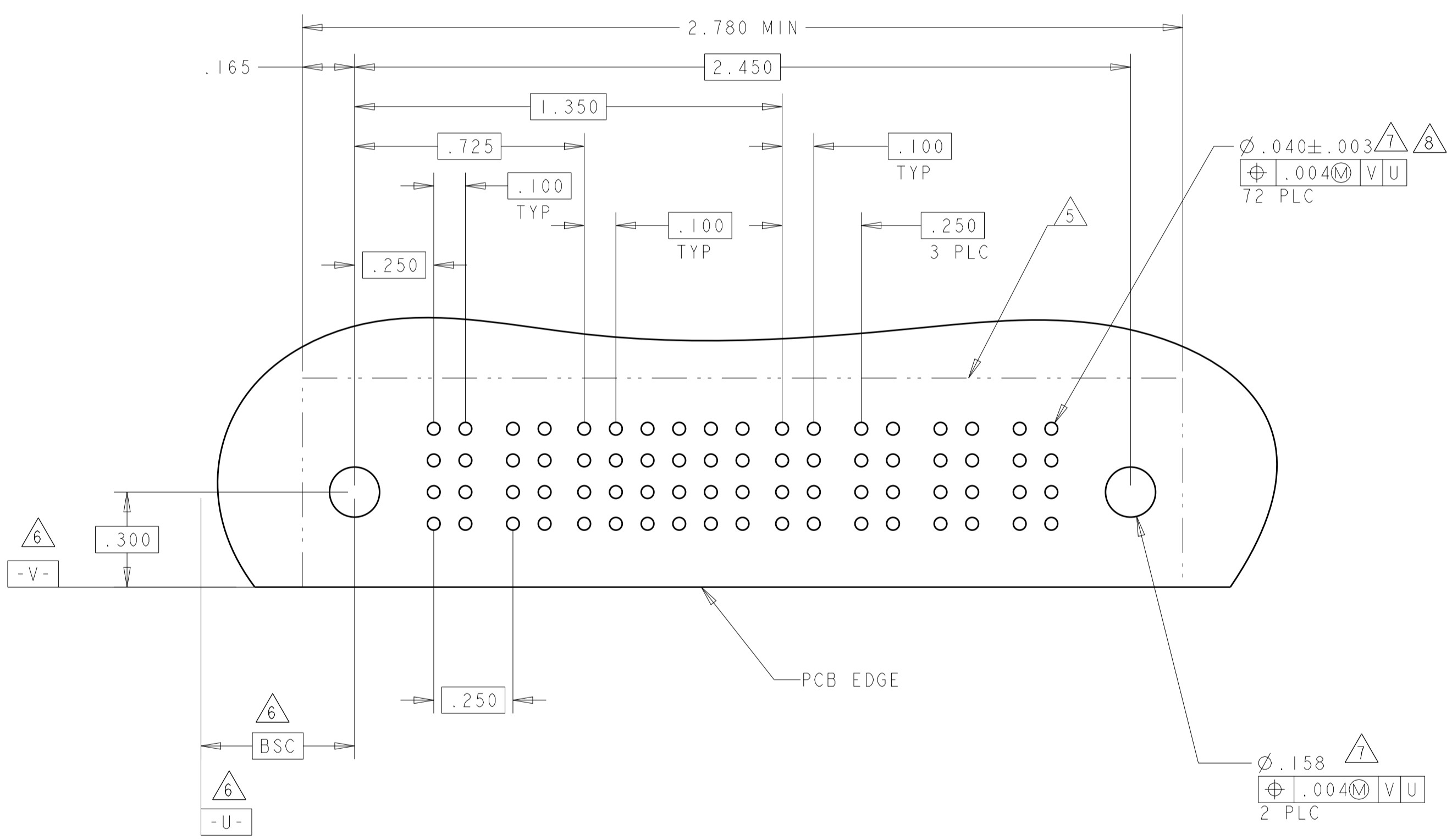

THIS DRAWING IS A CONTROLLED DOCUMENT.

DIMENSIONS: INCHES	TOLERANCES UNLESS OTHERWISE SPECIFIED: 0 PLC ±. 1 PLC ±.01 2 PLC ±.01 3 PLC ±.005 4 PLC ±.0020 ANGLES ±.2°	FINISH	OWN: R. GRZYBOWSKI 28FEB05 CHK: M. PERCHERKE 28FEB05 APVD: M. PERCHERKE NAME: M. PERCHERKE PRODUCT SPEC: 108-1973 APPLICATION SPEC: 114-13038 WEIGHT: -	TE Connectivity RIGHT ANGLE HEADER ASSEMBLY SOLDER TAILS, W/GUIDES MULTI-BEAM XL
MATERIAL			SIZE: 114-13038 CAGE CODE: - DRAWING NO: A100779 CUSTOMER DRAWING	RESTRICTED TO: - SCALE: 4:1 SHEET: 16 OF 20 REV: R3

LOC		DIST		REVISIONS			
ES	00	P	LTN	DESCRIPTION	DATE	DMN	APVD
		-		SEE SHEET 1			

PART NUMBER	ROWS	POWER		SIGNAL				POWER	
		P1	P2	1	2	3	4	P1	P2
6-6450330-3	D	PM	PM	J	J	J	J	PM	PM
	C			K	K	K	K		
	B			N	N	N	N		
	A			S	S	S	S		
IP + 16S + IP									

PART NUMBER	ROWS	POWER		SIGNAL		POWER	
		P1	P2	1	2	P3	P4
6-6450330-4	D	PM	PM	J	J	PM	PM
	C			K	K		
	B			N	N		
	A			FS	S		
2P + 8S + 2P							

N8

N9

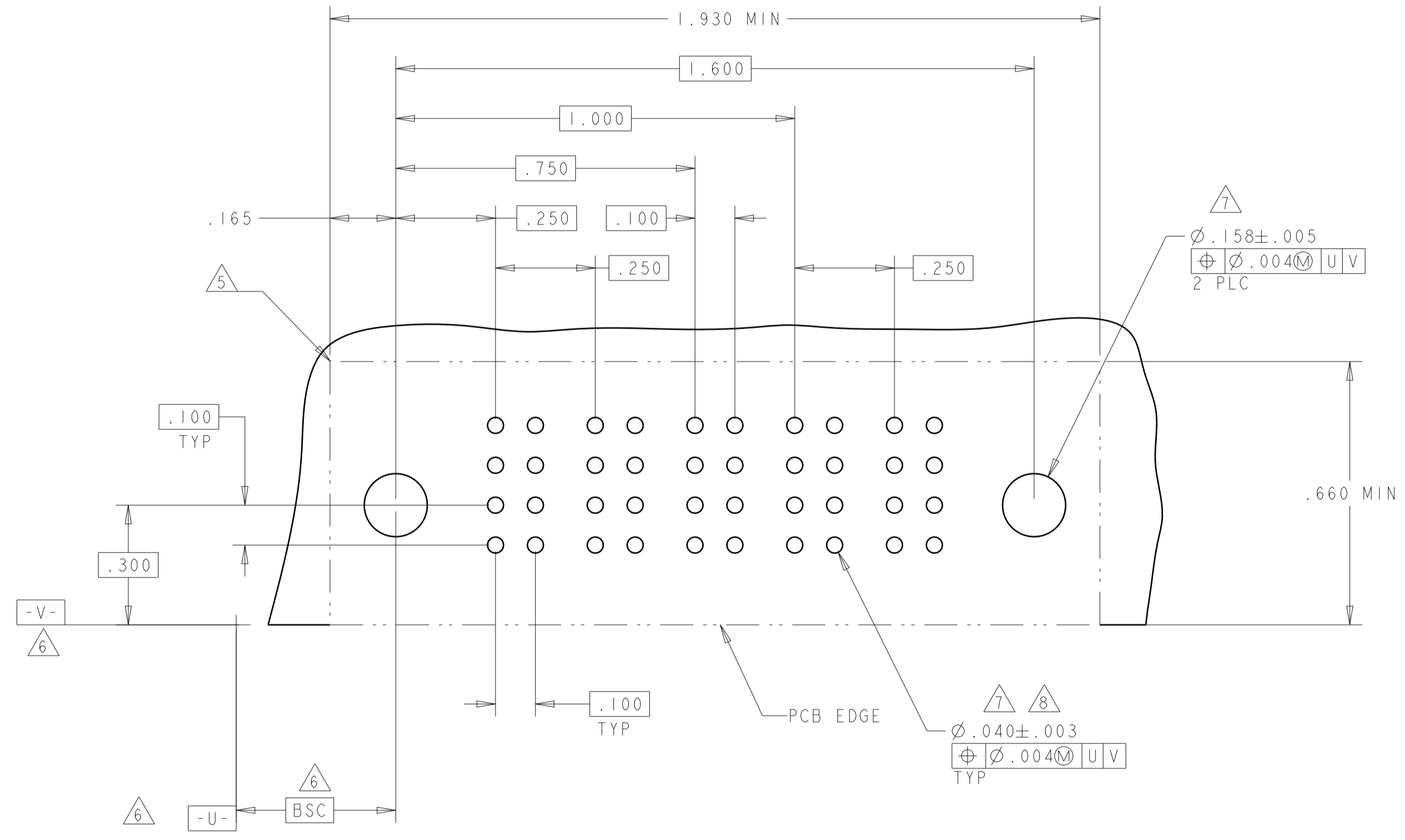
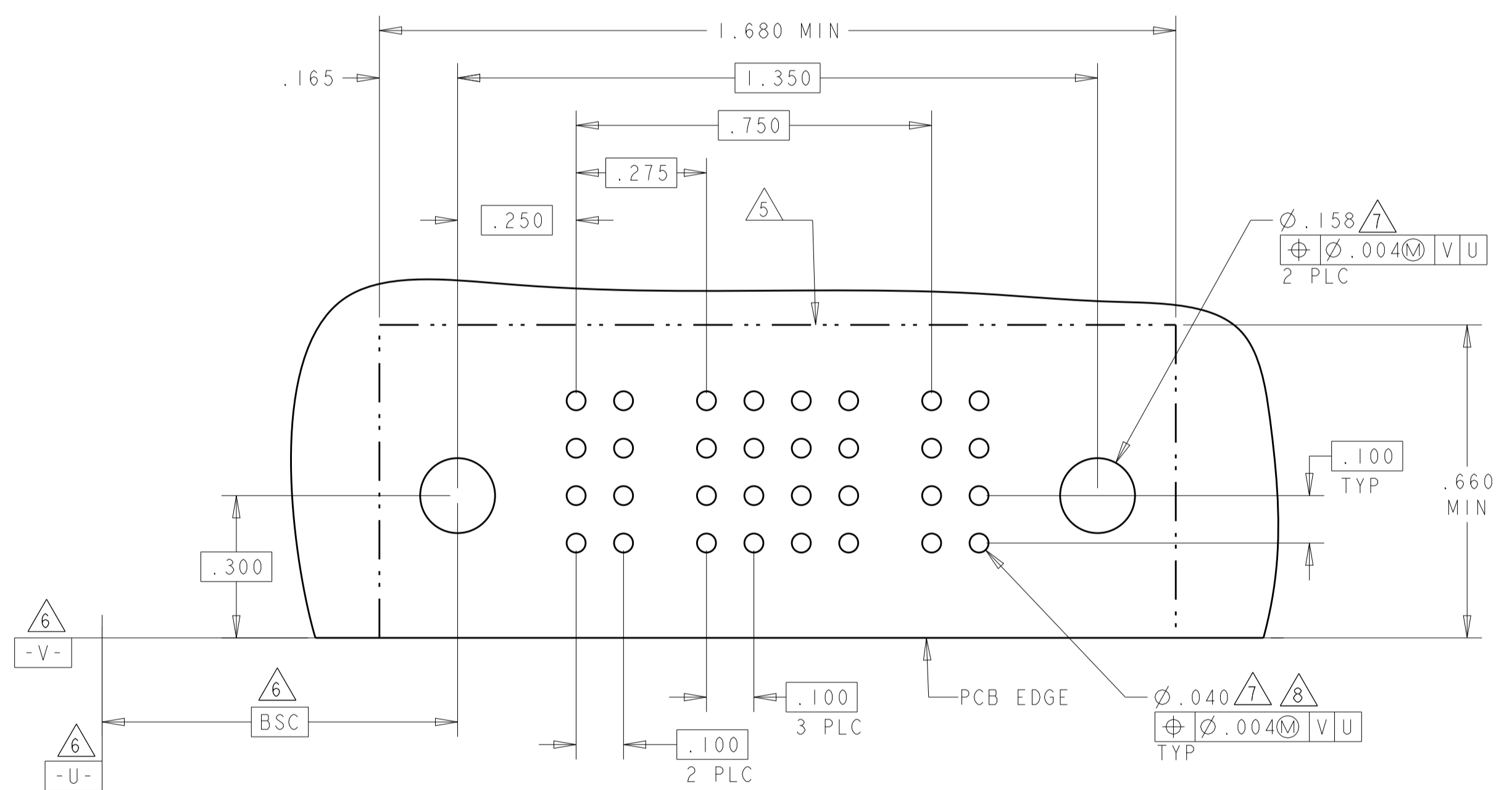

THIS DRAWING IS A CONTROLLED DOCUMENT.

DIMENSIONS:	TOLERANCES UNLESS OTHERWISE SPECIFIED:	DMN: R. GRZYBOWSKI 28FEB05	CHK: M. PERCHERKE 28FEB05	APVD: M. PERCHERKE	NAME: M. PERCHERKE
INCHES	0 PLC ± .01 1 PLC ± .01 2 PLC ± .01 3 PLC ± .005 4 PLC ± .002 ANGLES ± 2°	PRODUCT SPEC: 108-1973	APPLICATION SPEC: 114-13038	WEIGHT: -	SIZE: A
MATERIAL:	FINISH:	CAGE CODE: 6450330	DRAWING NO: 6450330	SCALE: 4:1	SHEET 17 OF 20
CUSTOMER DRAWING		REV: R3		RESTRICTED TO: -	

RIGHT ANGLE HEADER ASSEMBLY
 SOLDER TAILS, W/GUIDES
 MULTI-BEAM XL

LOC		DIST		REVISIONS			
ES	00	P	LTH	DESCRIPTION	DATE	OWN	APVD
		-		SEE SHEET 1			

PART NUMBER	ROWS	POWER		SIGNAL										POWER			
		P1	P2	1	2	3	4	5	6	7	8	9	10	P1	P2		
6-6450330-5	D C B A	PM	PM	J	J	J	J	J	J	J	J	J	J	J	J	PM	PM
				K	K	K	F	K	K	K	K	K	K	K	K		
				N	N	N	N	N	N	N	N	N	N	N	N		
IP + 40S + IP				S	S	S	S	S	S	S	S	S	S	S	S	S	S

PART NUMBER	ROWS	POWER		SIGNAL						POWER			
		P1	P2	1	2	3	4	5	6	P1	P2		
6-6450330-6	D C B A	PM	PM	J	J	J	J	J	J	J	J	PM	PM
				K	K	K	K	K	K	K	K		
				N	N	N	N	G	N	N	N		
IP + 24S + IP				S	S	S	S	S	S	S	S	S	S

NO CONTACTS LOADED

PART NUMBER	ROWS	POWER		SIGNAL						POWER			
		P1	P2	1	2	3	4	5	6	P1	P2		
6-6450330-7	D C B A	PM	PM	J	J	J	J	J	J	J	J	PM	PM
				K	K	K	K	K	K	K	K		
				N	N	N	N	G	N	N	N		
IP + 24S + IP				S	S	S	S	S	S	S	S	S	S

NO CONTACTS LOADED

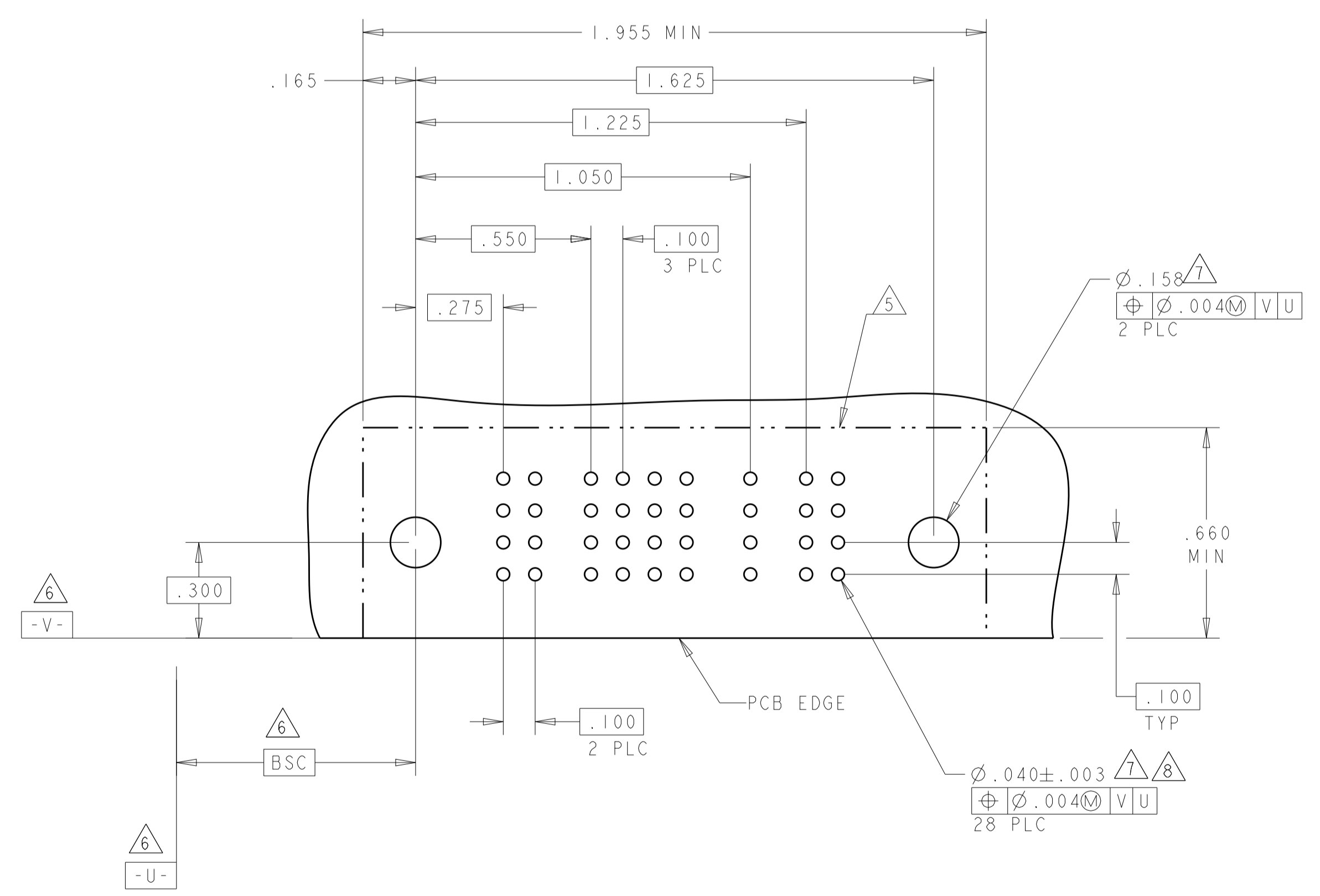
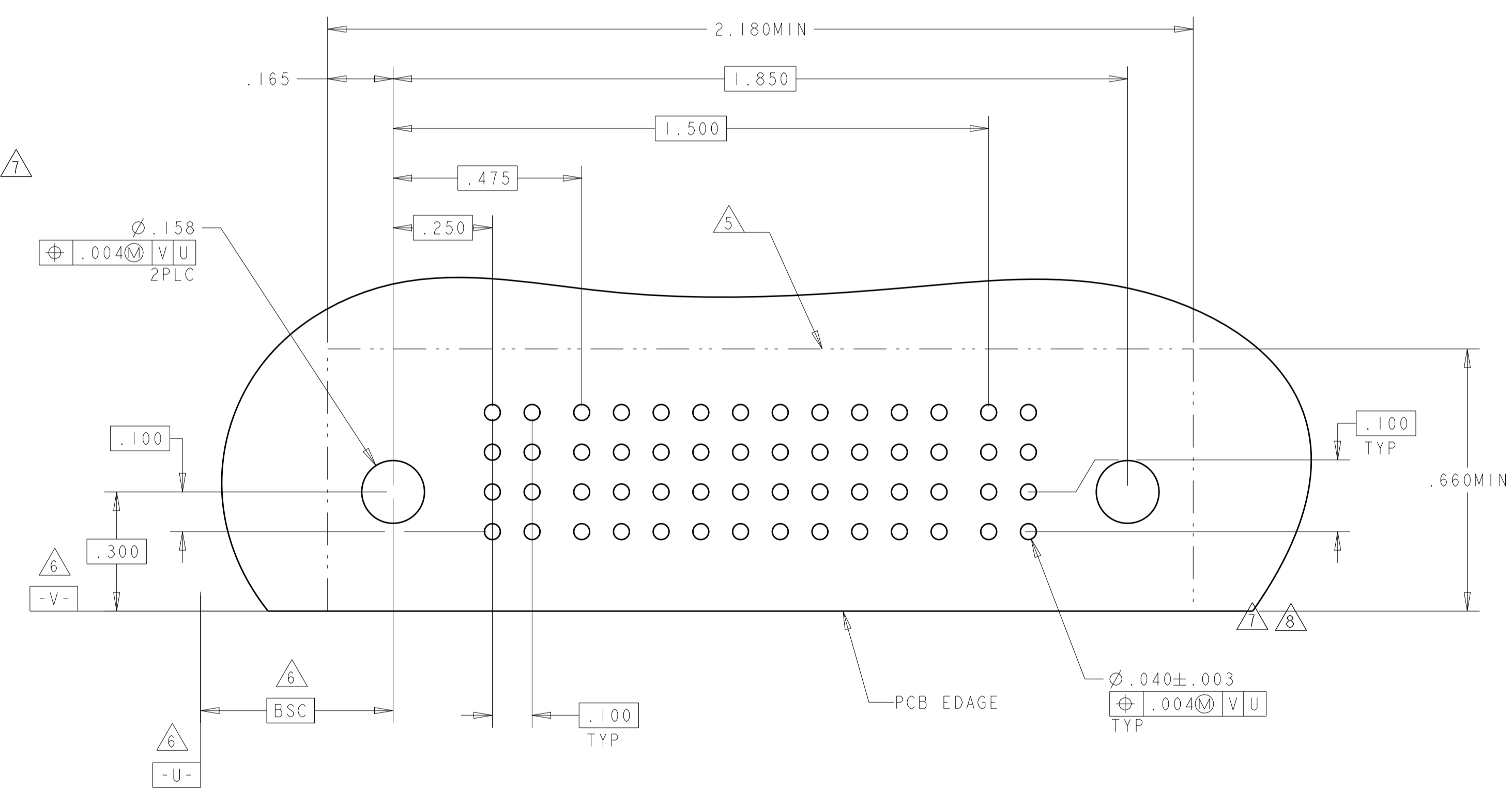

THIS DRAWING IS A CONTROLLED DOCUMENT.		OWN: R. GRZYBOWSKI 28FEB05	TE Connectivity
DIMENSIONS: INCHES		CHK: M. PERCHERKE 28FEB05	
TOLERANCES UNLESS OTHERWISE SPECIFIED:		APVD: M. PERCHERKE	NAME: RIGHT ANGLE HEADER ASSEMBLY SOLDER TAILS, W/GUIDES MULTI-BEAM XL
0 PLC ±.01		PRODUCT SPEC: 108-1973	SIZE: 114-13038
2 PLC ±.01		APPLICATION SPEC: 114-13038	RESTRICTED TO: A100779
3 PLC ±.005		WEIGHT: -	SCALE: 4:1
4 PLC ±.0020		CUSTOMER DRAWING	SHEET 18 OF 20
ANGLES ±.020		SCALE: 4:1	REV: R3

LOC		DIST		REVISIONS			
ES	00	P	LTH	DESCRIPTION	DATE	DMN	APVD
		-		SEE SHEET 1			

PART NUMBER	ROWS	POWER					SIGNAL								POWER					
		P1	P2	P3	P4	P5	1	2	3	4	5	6	7	8	P6	P7	P8	P9	P10	P11
6-6450330-8	D	PM	PM	PM	PM	PM	J	J	J	J	J	J	J	J	PM	PM	PM	PM	PM	PM
	C	PM	PM	PM	PM	PM	K	K	F	K	K	K	K	PM	PM	PM	PM	PM	PM	
	B	PM	PM	PM	PM	PM	N	N	N	N	N	N	N	PM	PM	PM	PM	PM	PM	
	A	PM	PM	PM	PM	PM	S	S	S	S	S	S	S	PM	PM	PM	PM	PM	PM	

5ACP + 32S + 6P

NO CONTACTS LOADED

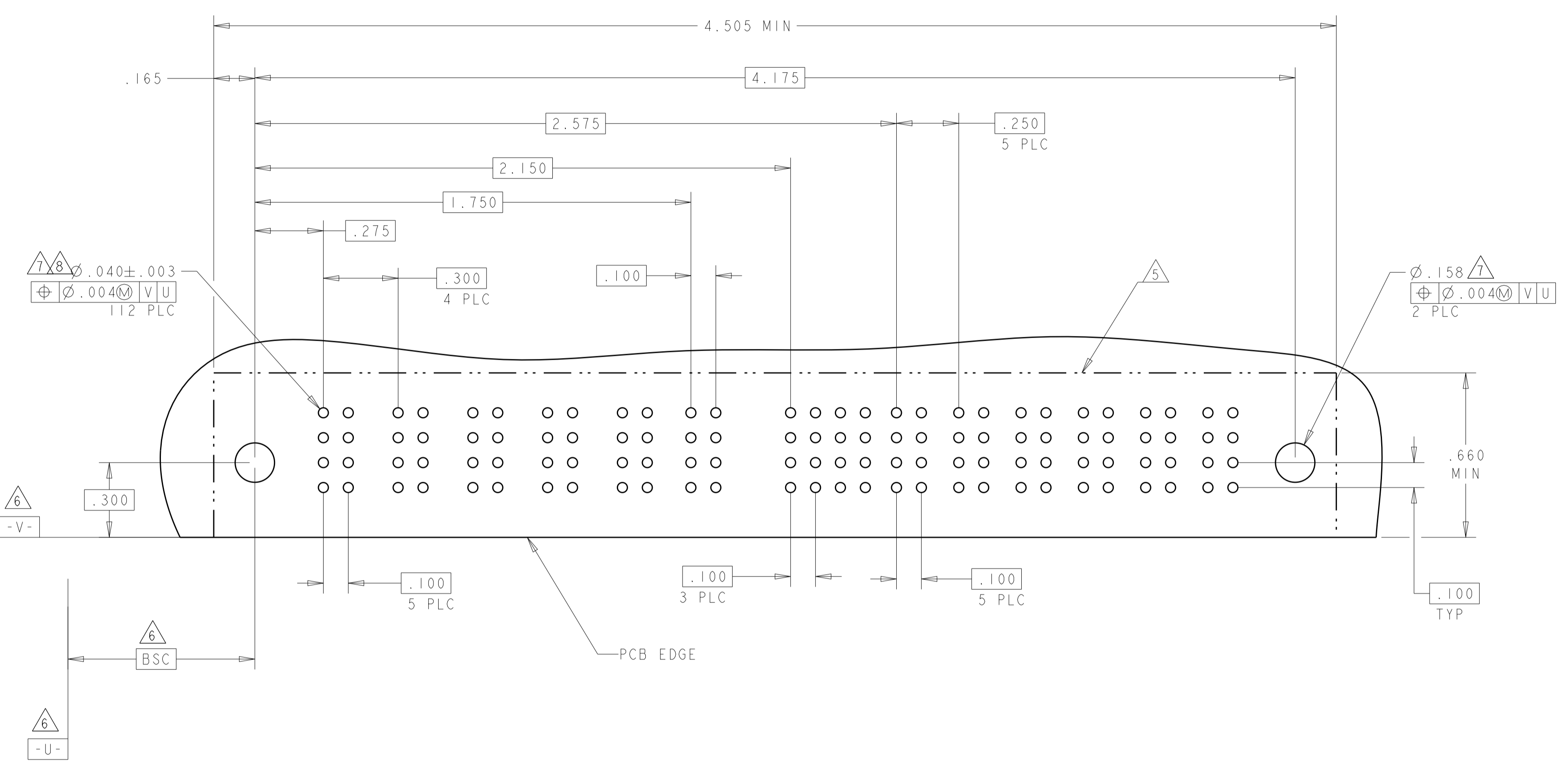

THIS DRAWING IS A CONTROLLED DOCUMENT.		DMN: R.GRZYBOWSKI 28FEB05	TE Connectivity
DIMENSIONS: INCHES		CHK: M.PERCHEK 28FEB05	
TOLERANCES UNLESS OTHERWISE SPECIFIED: 0 PLC ±. 1 PLC ±.01 2 PLC ±.01 3 PLC ±.005 4 PLC ±.0020 ANGLES ±2° FINISH		APVD: M.PERCHEK	NAME: RIGHT ANGLE HEADER ASSEMBLY SOLDER TAILS, W/GUIDES MULTI-BEAM XL
		PRODUCT SPEC: 108-1973	SIZE: A1
MATERIAL:		APPLICATION SPEC: 114-13038	CAGE CODE: 6450330
WEIGHT:		RESTRICTED TO:	SCALE: 4:1 SHEET 19 OF 20 REV: R3
CUSTOMER DRAWING			

LOC	DIST	REVISIONS			
P	LTN	DESCRIPTION	DATE	DMN	APVD
ES	00	SEE SHEET 1			

PART NUMBER	ROWS	POWER				SIGNAL						POWER	
		P1	P2	P3	P4	1	2	3	4	5	6	P5	P6
7-6450330-2	D	PM	PM	PM	PM	J	J	J	J	J	J	PM	PM
	C					K	K	K	K	K	K		
	B					N	N	N	N	N	N		
	A					H	H	H	H	H			

4P + 24S + 2P

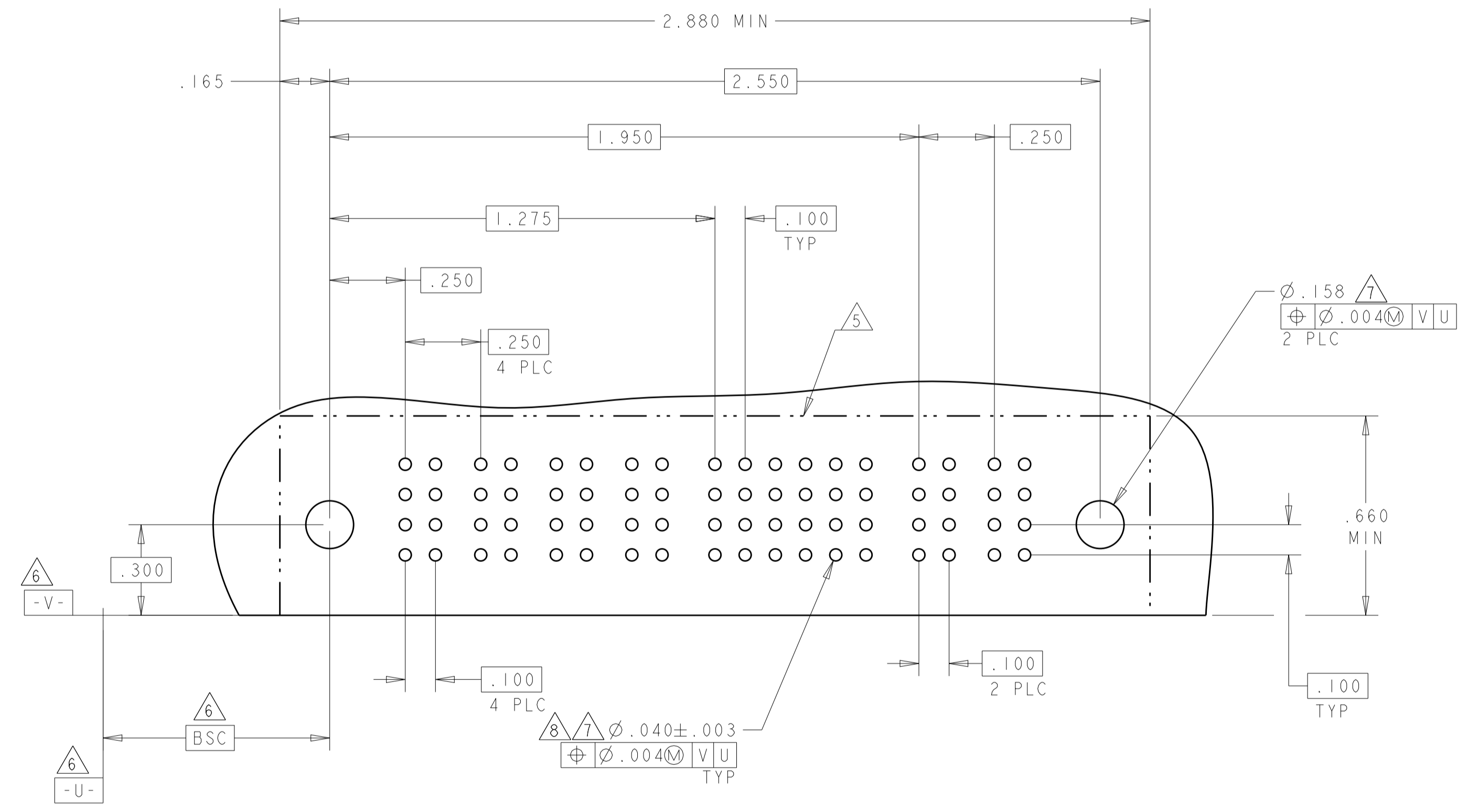

THIS DRAWING IS A CONTROLLED DOCUMENT.		DMN: R.GRZYBOWSKI 28FEB05	TE Connectivity
DIMENSIONS: INCHES		CHK: M.PERCHEK 28FEB05	
DIMENSIONS: INCHES 0 PLC ±. 1 PLC ±.01 2 PLC ±.01 3 PLC ±.005 4 PLC ±.0020 ANGLES ±.2°		APVD: M.PERCHEK	NAME: RIGHT ANGLE HEADER ASSEMBLY SOLDER TAILS, W/GUIDES MULTI-BEAM XL
TOLERANCES UNLESS OTHERWISE SPECIFIED:		PRODUCT SPEC: 108-1973	SIZE: A1
MATERIAL:		APPLICATION SPEC: 114-13038	CAGE CODE: 6450330
FINISH:		WEIGHT:	RESTRICTED TO:
CUSTOMER DRAWING		SCALE: 4:1	SHEET 20 OF 20 REV: R3



Компания «ЭлектроПласт» предлагает заключение долгосрочных отношений при поставках импортных электронных компонентов на взаимовыгодных условиях!

Наши преимущества:

- Оперативные поставки широкого спектра электронных компонентов отечественного и импортного производства напрямую от производителей и с крупнейших мировых складов;
- Поставка более 17-ти миллионов наименований электронных компонентов;
- Поставка сложных, дефицитных, либо снятых с производства позиций;
- Оперативные сроки поставки под заказ (от 5 рабочих дней);
- Экспресс доставка в любую точку России;
- Техническая поддержка проекта, помощь в подборе аналогов, поставка прототипов;
- Система менеджмента качества сертифицирована по Международному стандарту ISO 9001;
- Лицензия ФСБ на осуществление работ с использованием сведений, составляющих государственную тайну;
- Поставка специализированных компонентов (Xilinx, Altera, Analog Devices, Intersil, Interpoint, Microsemi, Aeroflex, Peregrine, Syfer, Eurofarad, Texas Instrument, Miteq, Cobham, E2V, MA-COM, Hittite, Mini-Circuits, General Dynamics и др.);

Помимо этого, одним из направлений компании «ЭлектроПласт» является направление «Источники питания». Мы предлагаем Вам помощь Конструкторского отдела:

- Подбор оптимального решения, техническое обоснование при выборе компонента;
- Подбор аналогов;
- Консультации по применению компонента;
- Поставка образцов и прототипов;
- Техническая поддержка проекта;
- Защита от снятия компонента с производства.



Как с нами связаться

Телефон: 8 (812) 309 58 32 (многоканальный)

Факс: 8 (812) 320-02-42

Электронная почта: org@eplast1.ru

Адрес: 198099, г. Санкт-Петербург, ул. Калинина, дом 2, корпус 4, литера А.