

FEATURES**Downconverter****Conversion loss**

10.5 dB typical for 7 GHz to 22 GHz

11 dB typical for 22 GHz to 40 GHz

LO to RF isolation

34 dB typical for 7 GHz to 22 GHz

32 dB typical for 22 GHz to 40 GHz

LO to IF isolation

32 dB typical for 7 GHz to 22 GHz

50 dB typical for 22 GHz to 40 GHz

RF to IF isolation

14 dB typical for 7 GHz to 22 GHz

29 dB typical for 22 GHz to 40 GHz

IP3: 20 dBm typical**IP2: 40 dBm typical****Input power for P1dB**

11 dBm typical for 7 GHz to 22 GHz

12 dBm typical for 22 GHz to 40 GHz

IF frequency range: dc to 10**Passive, no dc bias required****Small size: 1.38 mm × 0.81 mm × 0.102 mm****APPLICATIONS****Point to point radios****Point to multipoint radios and very small aperture terminals
(VSATs)****Test equipment and sensors****Military end use****GENERAL DESCRIPTION**

The HMC774A is a general-purpose, gallium arsenide (GaAs), monolithic microwave integrated circuit (MMIC), double balanced mixer chip that can be used as an upconverter or downconverter from 7 GHz to 40 GHz. This mixer requires no external components or matching circuitry.

FUNCTIONAL BLOCK DIAGRAM

Figure 1.

16896-001

The HMC774A provides excellent local oscillator (LO) to radio frequency (RF) and LO to intermediate frequency (IF) suppression due to optimized balun structures. The mixer operates well with LO drive levels of 13 dBm. The HMC774A is also available in surface-mount technology format as the HMC774ALC3B.

TABLE OF CONTENTS

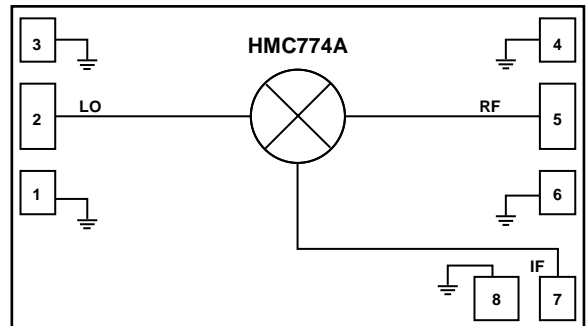
Features	1	Upconverter	10
Applications.....	1	Isolations and Return Loss.....	12
Functional Block Diagram	1	IF Bandwidth	14
General Description	1	Spurious Performance	15
Revision History	2	Theory of Operation	16
Specifications.....	3	Applications Information	17
Electrical Specifications.....	3	Typical Application Circuit.....	17
Absolute Maximum Ratings.....	5	Assembly Diagram	17
Thermal Resistance	5	Mounting and Bonding Techniques for Millimeter Wave GaAs MMICs	18
ESD Caution.....	5	Outline Dimensions	19
Pin Configuration and Function Descriptions.....	6	Ordering Guide	19
Interface Schematics.....	6		
Typical Performance Characteristics	7		
Downconverter	7		

REVISION HISTORY

5/2018—Revision 0: Initial Version

SPECIFICATIONS

ELECTRICAL SPECIFICATIONS

$T_A = 25^\circ\text{C}$, IF = 500 MHz, LO drive = 13 dBm, RF frequency range = 7 GHz to 22 GHz, and all measurements performed as a downconverter with the upper sideband selected, unless otherwise noted.

Table 1.

Parameter	Symbol	Min	Typ	Max	Unit
FREQUENCY RANGE					
Radio Frequency	RF	7		22	GHz
Local Oscillator	LO	7		22	GHz
Intermediate Frequency	IF	DC		10	GHz
CONVERSION LOSS					
			10.5	14	dB
NOISE FIGURE					
			13		dB
ISOLATION					
LO to RF			34		dB
LO to IF		17	32		dB
RF to IF		5	14		dB
INPUT THIRD-ORDER INTERCEPT					
	IP3	11	20		dBm
INPUT SECOND-ORDER INTERCEPT					
	IP2		40		dBm
INPUT POWER					
1 dB Compression	P1dB		11		dBm
UPCONVERTER PERFORMANCE					
Conversion Loss			10		dB
Input Third-Order Intercept	IP3		17.5		dBm
RETURN LOSS					
RF Port			7.5		dB
LO Port			8		dB

$T_A = 25^\circ\text{C}$, $IF = 500\text{ MHz}$, $LO\text{ drive} = 13\text{ dBm}$, $RF\text{ frequency range} = 22\text{ GHz to }40\text{ GHz}$, and all measurements performed as a downconverter with the upper sideband selected, unless otherwise noted.

Table 2.

Parameter	Symbol	Min	Typ	Max	Unit
FREQUENCY RANGE					
Radio Frequency	RF	22		40	GHz
Local Oscillator	LO	22		40	GHz
Intermediate Frequency	IF	DC		10	GHz
CONVERSION LOSS			11	16	dB
NOISE FIGURE			12		dB
ISOLATION					
LO to RF			32		dB
LO to IF		38	50		dB
RF to IF		16	29		dB
INPUT THIRD-ORDER INTERCEPT	IP3	12	20		dBm
INPUT SECOND-ORDER INTERCEPT	IP2		40		dBm
INPUT POWER					
1 dB Compression	P1dB		12		dBm
UPCONVERTER PERFORMANCE					
Conversion Loss			11.5		dB
Input Third-Order Intercept	IP3		18		dBm
RETURN LOSS					
RF Port			7		dB
LO Port			9		dB

ABSOLUTE MAXIMUM RATINGS

Table 3.

Parameter	Rating
RF Input Power	21 dBm
LO Input Power	25 dBm
IF Input Power	21 dBm
IF Source and Sink Current	3 mA
Channel Temperature	175°C
Continuous Power Dissipation, P_{DISS} ($T_A = 85^\circ\text{C}$, Derate 2.9 mW/ $^\circ\text{C}$ Above 85°C)	189 mW
Storage Temperature Range	-65 to +150°C
Operating Temperature Range	-55 to +85°C
Electrostatic Discharge (ESD) Sensitivity	
Human Body Model (HBM)	1500 V
Field Induced Charged Device Model (FICDM)	1250 V

Stresses at or above those listed under Absolute Maximum Ratings may cause permanent damage to the product. This is a stress rating only; functional operation of the product at these or any other conditions above those indicated in the operational section of this specification is not implied. Operation beyond the maximum operating conditions for extended periods may affect product reliability.

THERMAL RESISTANCE

Thermal performance is directly linked to printed circuit board (PCB) design and operating environment. Careful attention to PCB thermal design is required.

θ_{JC} is the junction to case thermal resistance.

Table 4. Thermal Resistance

Package Type	θ_{JC}	Unit
CHIP ¹	274	$^\circ\text{C}/\text{W}$

¹ See JEDEC standard JESD51-2 for additional information on optimizing the thermal impedance (PCB with 3 × 3 vias).

ESD CAUTION



ESD (electrostatic discharge) sensitive device. Charged devices and circuit boards can discharge without detection. Although this product features patented or proprietary protection circuitry, damage may occur on devices subjected to high energy ESD. Therefore, proper ESD precautions should be taken to avoid performance degradation or loss of functionality.

PIN CONFIGURATION AND FUNCTION DESCRIPTIONS

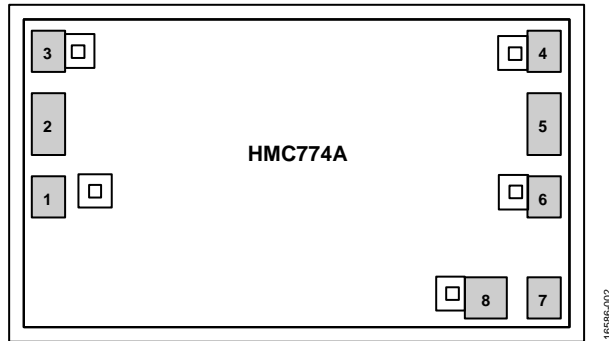

Figure 2. Pad Configuration

Table 5. Pad Function Descriptions

Pin No.	Mnemonic	Description
1, 3, 4, 6, 8, Die Bottom	GND	Ground. Connect these pads to RF/dc ground. See Figure 3 for the GND interface schematic.
2	LO	Local Oscillator Port. This pad is dc-coupled and matched to 50 Ω. See Figure 4 for the LO interface schematic.
5	RF	Radio Frequency Port. This pad is dc-coupled and matched to 50 Ω. See Figure 5 for the RF interface schematic.
7	IF	Intermediate Frequency Port. This pad is dc-coupled. For applications not requiring operation to dc, dc block this port externally using a series capacitor of a value chosen to pass the necessary IF frequency range. For operation to dc, this pin must not source or sink more than 3 mA of current or die malfunction and possible die failure can result. See Figure 6 for the IF interface schematic.

INTERFACE SCHEMATICS



Figure 3. GND Interface

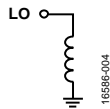

Figure 4. LO Interface

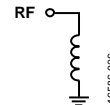

Figure 5. RF Interface

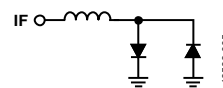

Figure 6. IF Interface

TYPICAL PERFORMANCE CHARACTERISTICS

DOWNCONVERTER

Upper Sideband, IF = 500 MHz

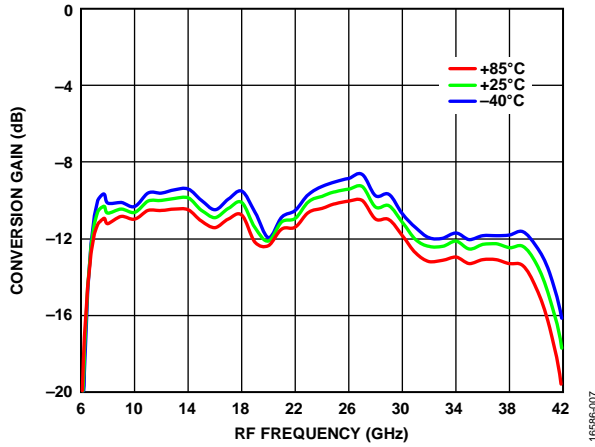

Figure 7. Conversion Gain vs. RF Frequency at Various Temperatures, LO Drive = 13 dBm

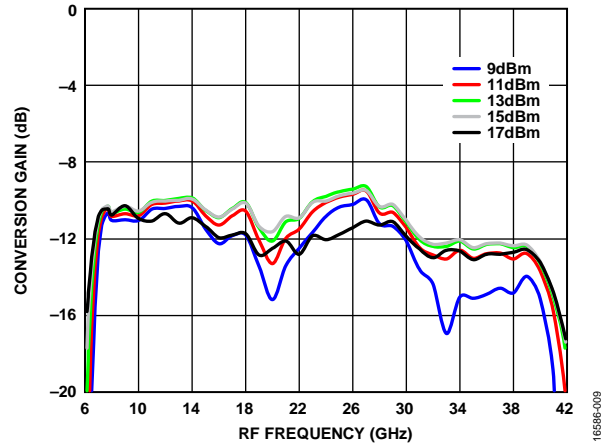

Figure 10. Conversion Gain vs. RF Frequency at Various LO Powers

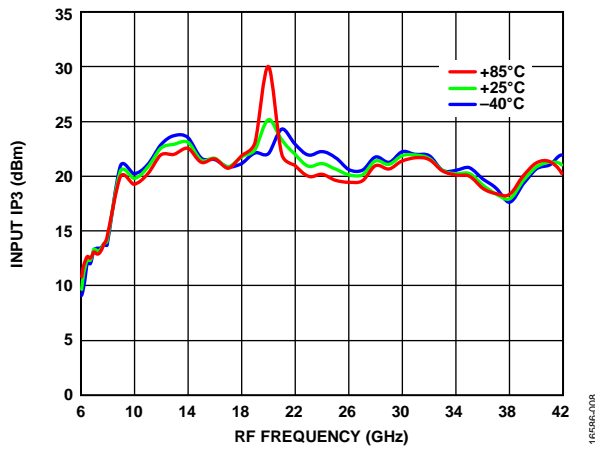

Figure 8. Input IP3 vs. RF Frequency at Various Temperatures, LO Drive = 13 dBm

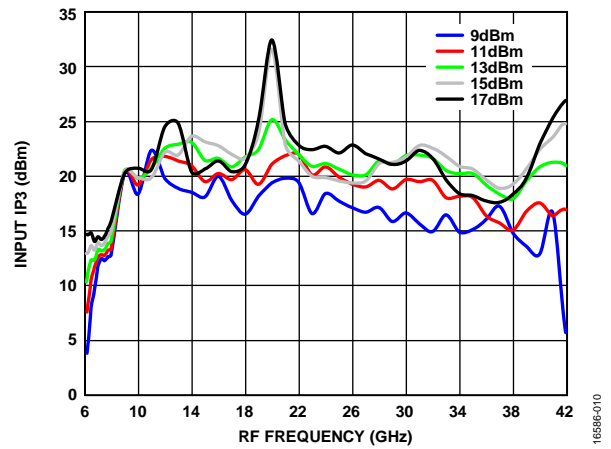

Figure 11. Input IP3 vs. RF Frequency at Various LO Powers

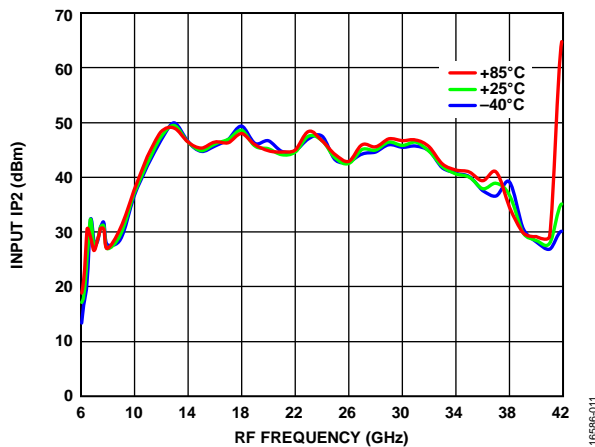

Figure 9. Input IP2 vs. RF Frequency at Various Temperatures, LO Drive = 13 dBm

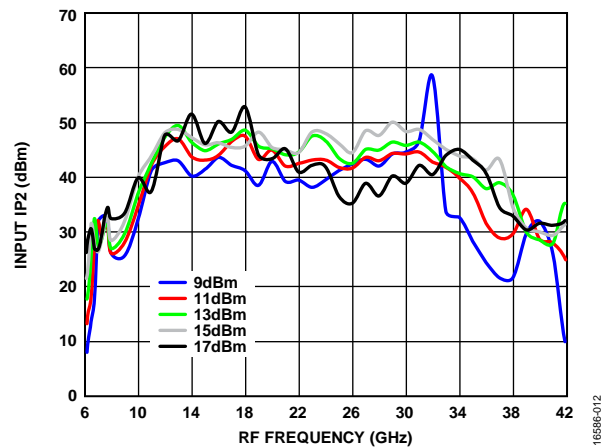

Figure 12. Input IP2 vs. RF Frequency at Various LO Powers

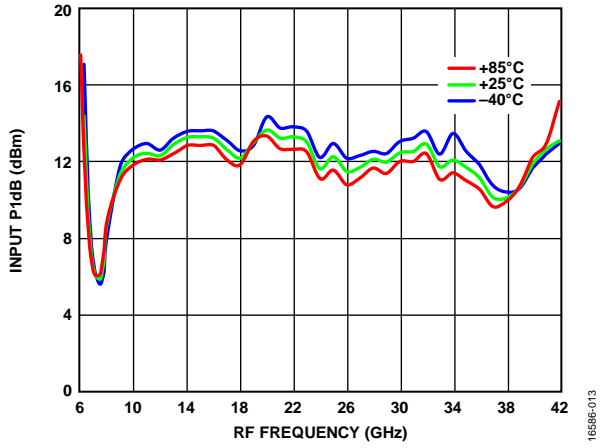

Figure 13. Input P1dB vs. RF Frequency at Various Temperatures, LO Drive = 13 dBm

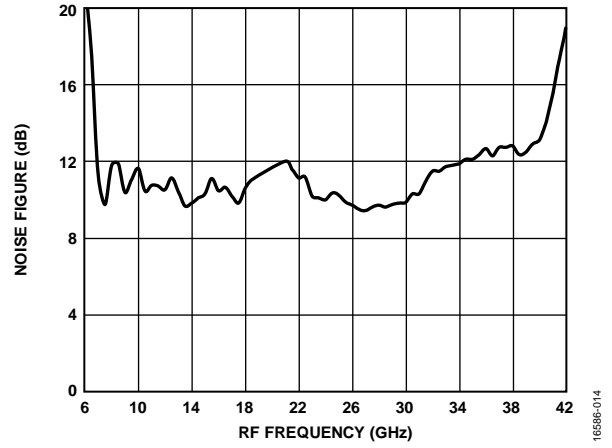

Figure 14. Noise Figure vs. RF Frequency

Upper Sideband, IF = 10,000 MHz

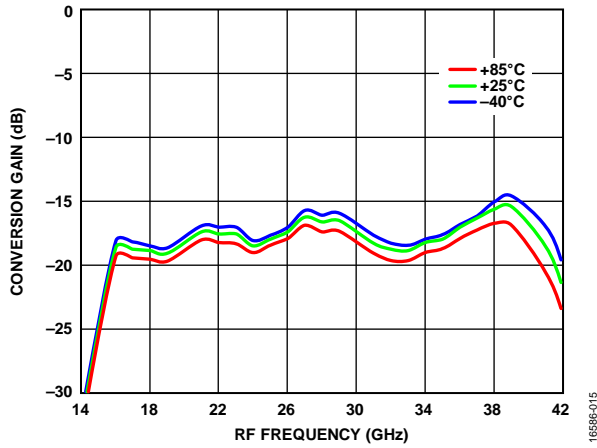

Figure 15. Conversion Gain vs. RF Frequency at Various Temperatures, LO Drive = 13 dBm

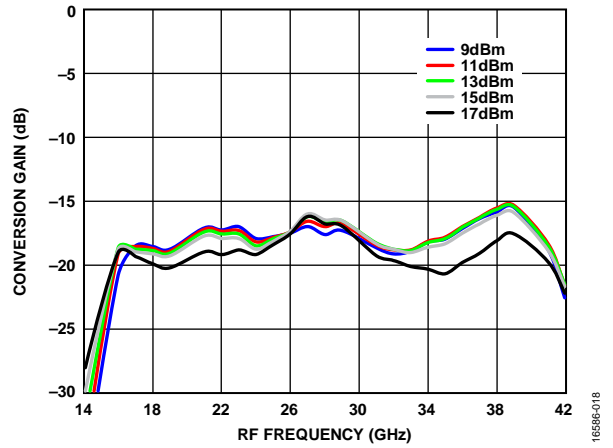

Figure 18. Conversion Gain vs. RF Frequency at Various LO Drives

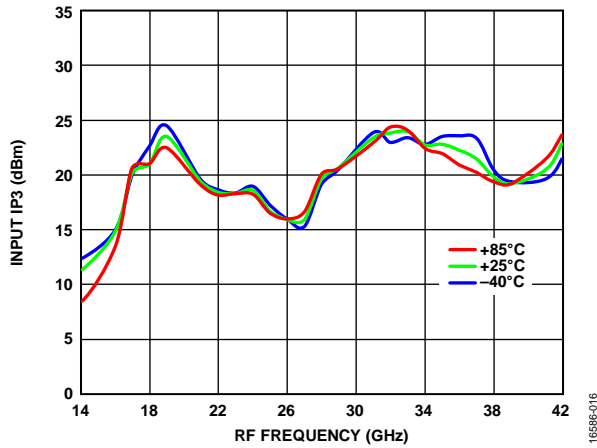

Figure 16. Input IP3 vs. RF Frequency at Various Temperatures, LO Drive = 13 dBm

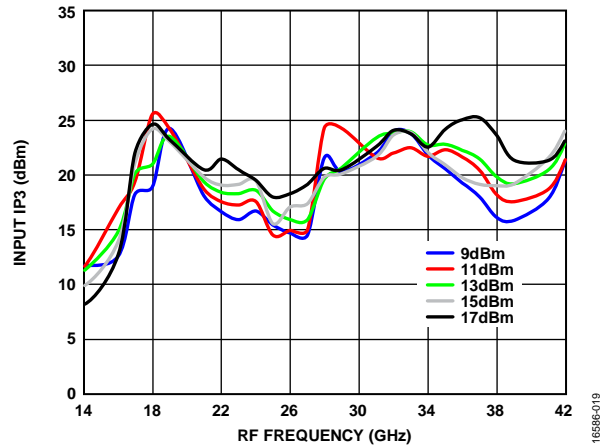

Figure 19. Input IP3 vs. RF Frequency at Various LO Drives

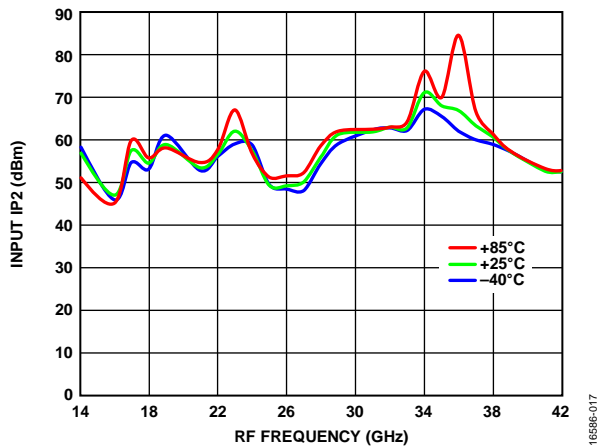

Figure 17. Input IP2 vs. RF Frequency at Various Temperatures, LO Drive = 13 dBm

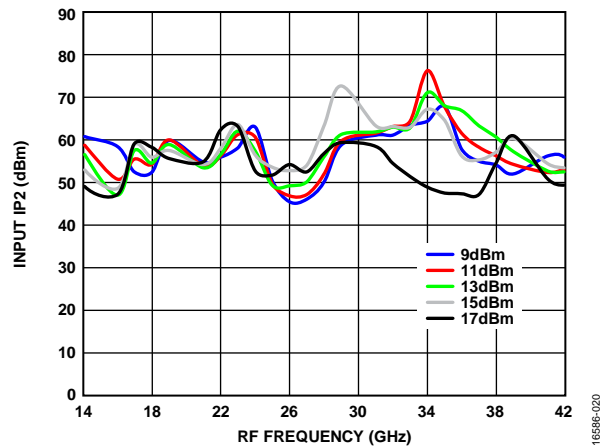

Figure 20. Input IP2 vs. RF Frequency at Various LO Drives

UPCONVERTER

Upper Sideband, IF = 500 MHz

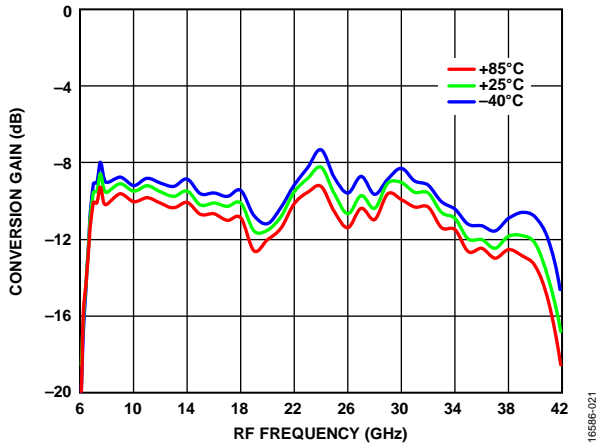

Figure 21. Conversion Gain vs. RF Frequency at Various Temperatures, LO Drive = 13 dBm

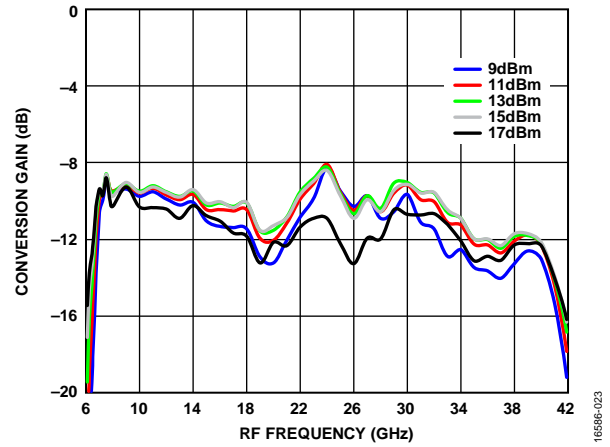

Figure 23. Conversion Gain vs. RF Frequency at Various LO Powers

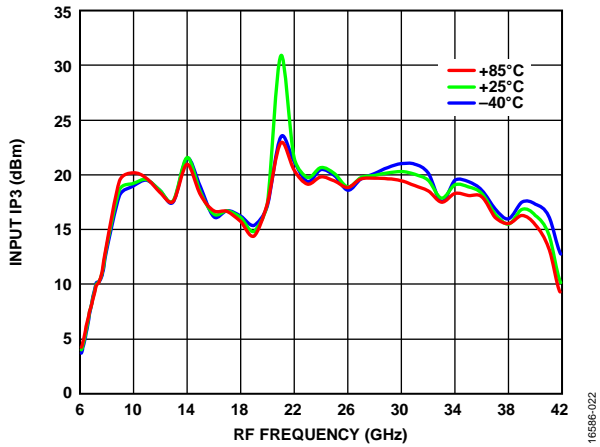

Figure 22. Input IP3 vs. RF Frequency at Various Temperatures, LO Drive = 13 dBm

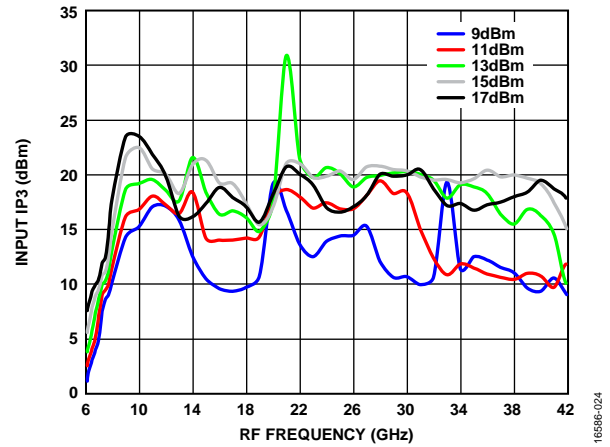

Figure 24. Input IP3 vs. RF Frequency at Various LO Powers

Upper Sideband, IF = 10,000 MHz

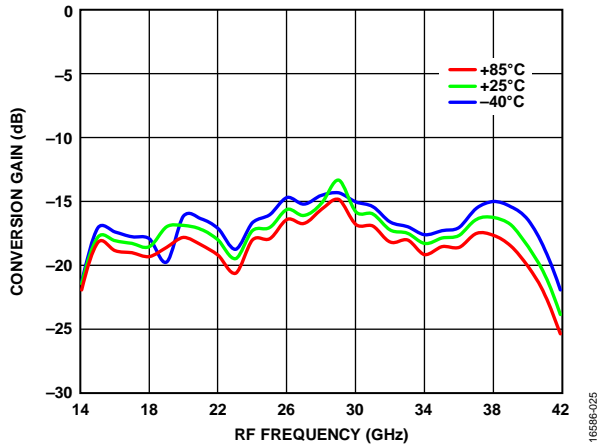

Figure 25. Conversion Gain vs. RF Frequency at Various Temperatures, LO Drive = 13 dBm

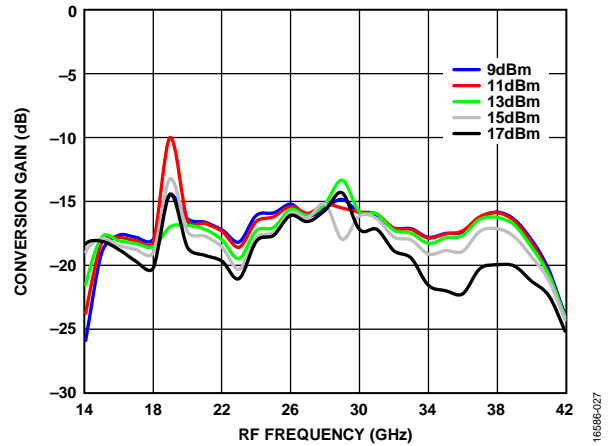

Figure 27. Conversion Gain vs. RF Frequency at Various LO Powers

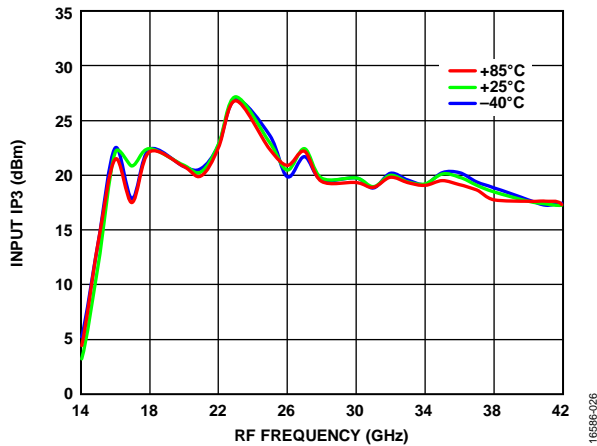

Figure 26. Input IP3 vs. RF Frequency at Various Temperatures, LO Drive = 13 dBm

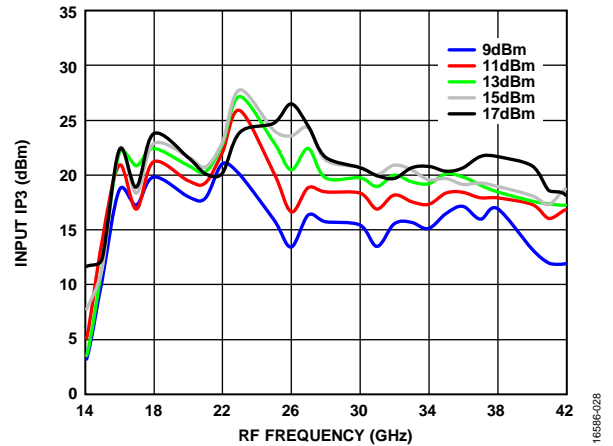

Figure 28. Input IP3 vs. RF Frequency at Various LO Powers

ISOLATIONS AND RETURN LOSS

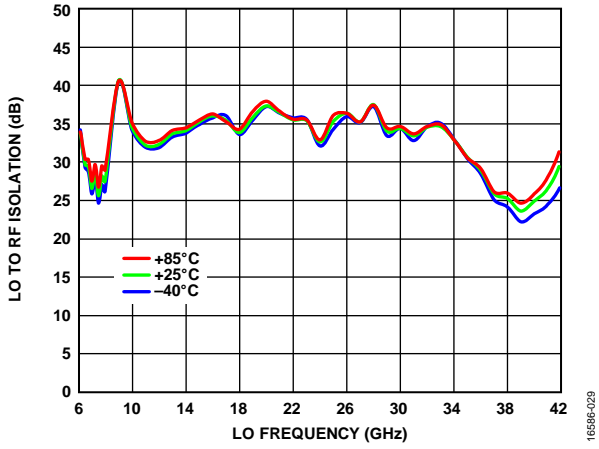

Figure 29. LO to RF Isolation vs. LO Frequency at Various Temperatures

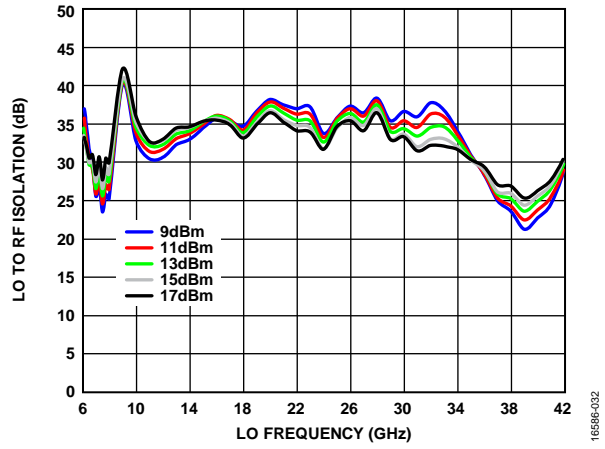

Figure 32. LO to RF Isolation vs. LO Frequency at Various LO Drives

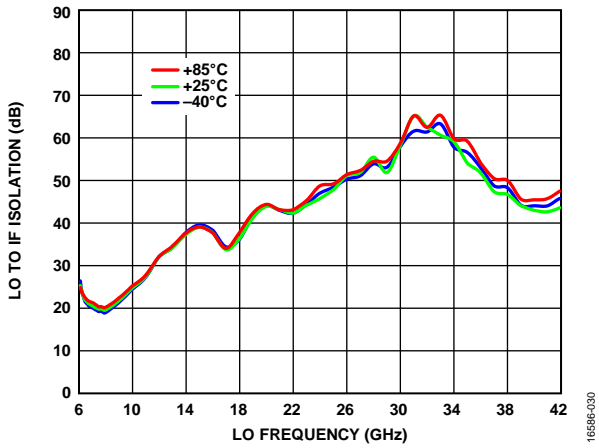

Figure 30. LO to IF Isolation vs. LO Frequency at Various Temperatures

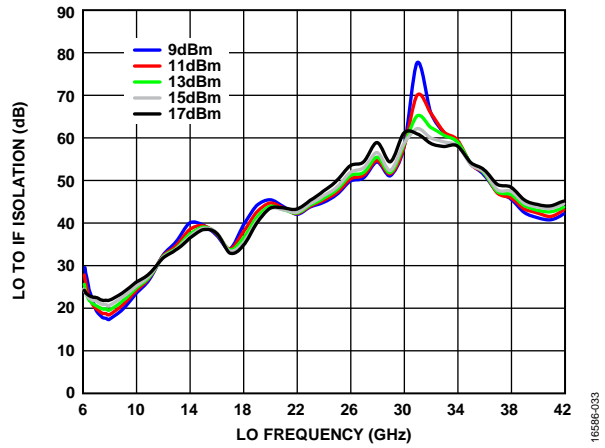

Figure 33. LO to IF Isolation vs. LO Frequency at Various LO Drives

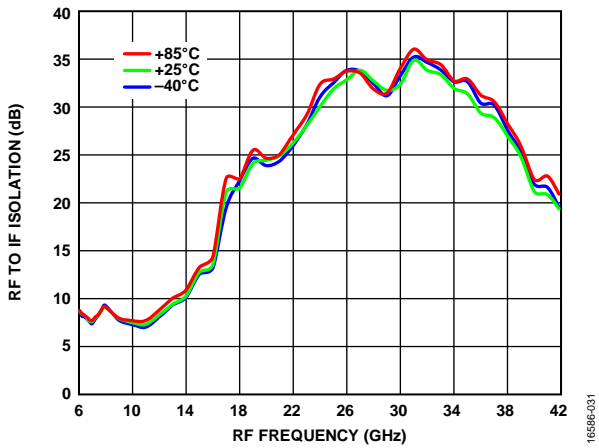

Figure 31. RF to IF Isolation vs. RF Frequency at Various Temperatures

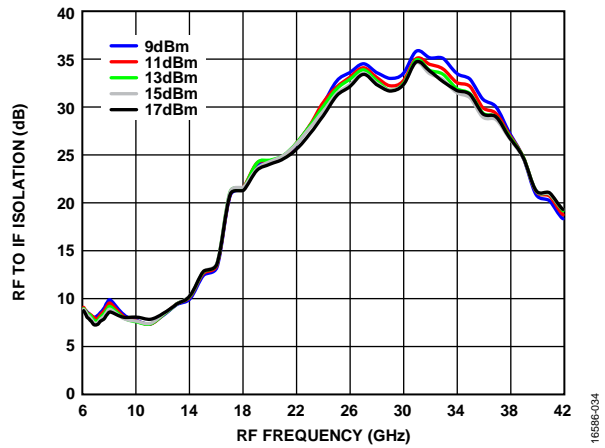

Figure 34. RF to IF Isolation vs. RF Frequency at Various LO Drives

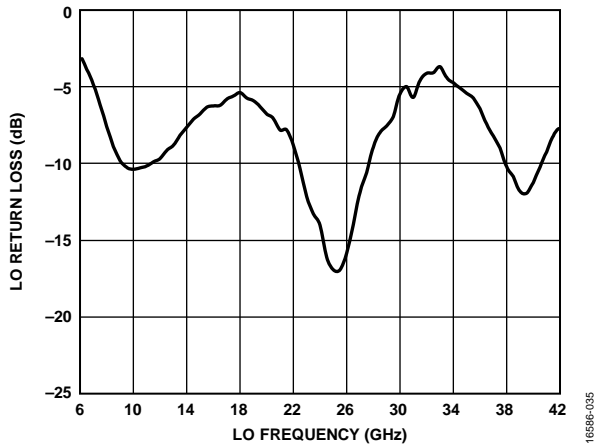

Figure 35. LO Return Loss vs. LO Frequency

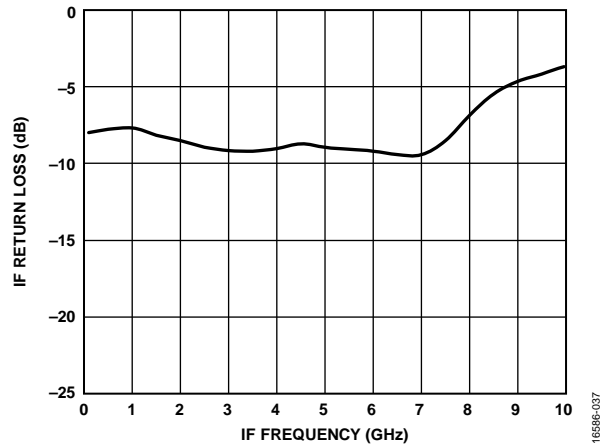

Figure 37. IF Return Loss vs. IF Frequency

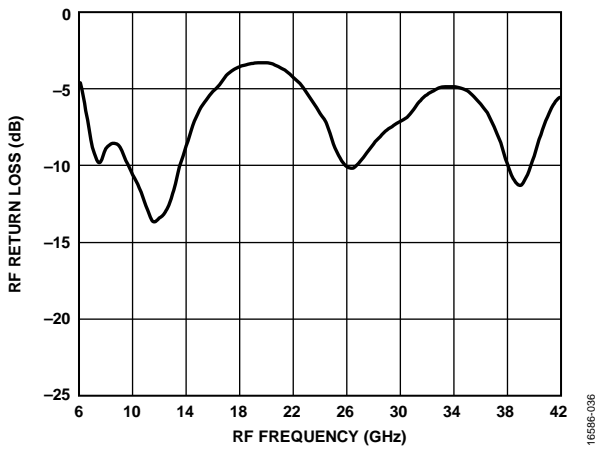

Figure 36. RF Return Loss vs. RF Frequency

16596-035

16596-037

16596-036

IF BANDWIDTH

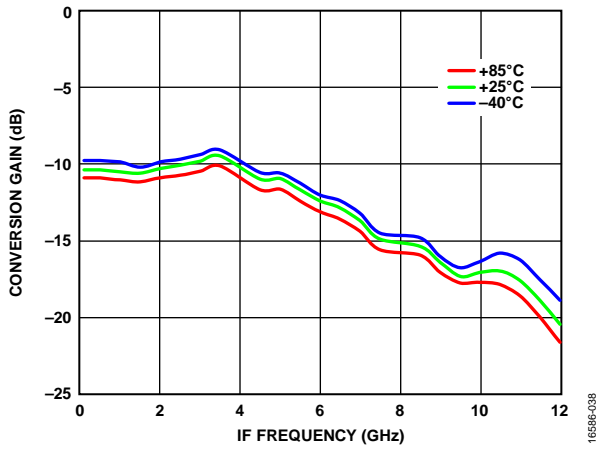

Figure 38. Conversion Gain vs. IF Frequency at Various Temperatures, LO Frequency = 8 GHz

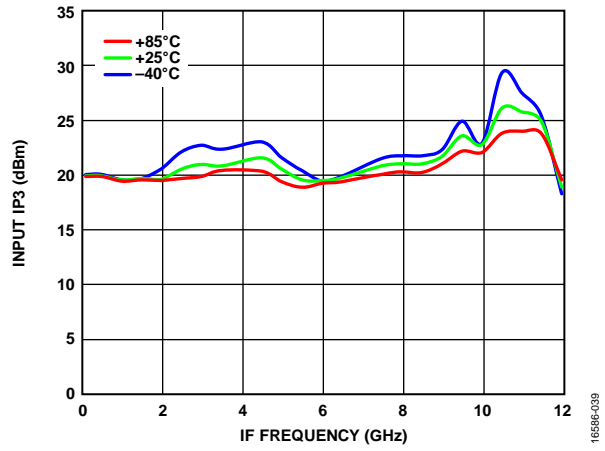

Figure 39. Input IP3 vs. IF Frequency at Various Temperatures, LO Frequency = 8 GHz

SPURIOUS PERFORMANCE

M × N Spurious Outputs, Downconverter, Lower Sideband, IF = 10000 MHz

Mixer spurious products are measured in decibels from the IF output power level. Spurious values are (M × RF) – (N × LO). N/A means not applicable.

The RF frequency = 7.5 GHz, and the RF input power = –10 dBm. The LO frequency = 17.5 GHz, and the LO input power = +13 dBm.

		N × LO					
		0	1	2	3	4	5
M × RF	0	N/A	1	31	N/A	N/A	N/A
	1	6	0	36	33	N/A	N/A
	2	65	49	80	62	N/A	N/A
	3	70	58	71	78	53	N/A
	4	78	71	58	83	62	N/A
	5	62	81	49	66	72	32

The RF frequency = 17.5 GHz, and the RF input power = –10 dBm. The LO frequency = 27.5 GHz, and the LO input power = +13 dBm.

		N × LO					
		0	1	2	3	4	5
M × RF	0	N/A	7	N/A	N/A	N/A	N/A
	1	3	0	27	N/A	N/A	N/A
	2	71	48	70	48	N/A	N/A
	3	N/A	81	85	79	N/A	N/A
	4	N/A	N/A	55	91	91	55
	5	N/A	N/A	N/A	60	91	87

The RF frequency = 27.5 GHz, and the RF input power = –10 dBm. The LO frequency = 37.5 GHz, and the LO input power = +13 dBm.

		N × LO					
		0	1	2	3	4	5
M × RF	0	N/A	5	N/A	N/A	N/A	N/A
	1	16	0	23	N/A	N/A	N/A
	2	N/A	49	69	N/A	N/A	N/A
	3	N/A	53	64	83	N/A	N/A
	4	N/A	N/A	78	88	56	N/A
	5	N/A	N/A	N/A	N/A	93	52

M × N Spurious Outputs, Upconverter, Lower Sideband, IF = 10000 MHz

Mixer spurious products are measured in decibels from the RF output power level. Spurious values are (M × IF) – (N × LO). N/A means not applicable.

The IF frequency = 7.5 GHz, and the IF input power = –10 dBm. The LO frequency = 17.5 GHz, and the LO input power = +13 dBm.

		N × LO				
		0	1	2	3	4
M × IF	4	62	75	72	84	63
	3	83	72	75	64	54
	2	47	73	51	57	N/A
	1	4	0	13	35	N/A
	0	N/A	1	22	N/A	N/A
	1	4	3	33	N/A	N/A
	2	47	55	15	N/A	N/A
	3	83	63	N/A	N/A	N/A
4	60	55	N/A	N/A	N/A	

THEORY OF OPERATION

The HMC774A is a general-purpose, GaAs, MMIC, double balanced mixer chip that can be used as an upconverter or downconverter from 7 GHz to 40 GHz.

When used as a downconverter, the HMC774A down converts RF between 7 GHz and 40 GHz to IF between dc and 10 GHz.

When used as an upconverter, the mixer up converts IF between dc and 10 GHz to radio frequencies between 7 GHz and 40 GHz.

The mixer performs well with LO drives of at least 13 dBm, and the mixer provides excellent LO to RF and LO to IF suppression due to optimized balun structures.

APPLICATIONS INFORMATION

TYPICAL APPLICATION CIRCUIT

Figure 40 shows the typical application circuit for the HMC774A. The HMC774A is a passive device and does not require any

external components. The LO and RF pins are internally ac-coupled. When IF operation is not required until dc, it is recommended to use an ac-coupled capacitor at the IF port.

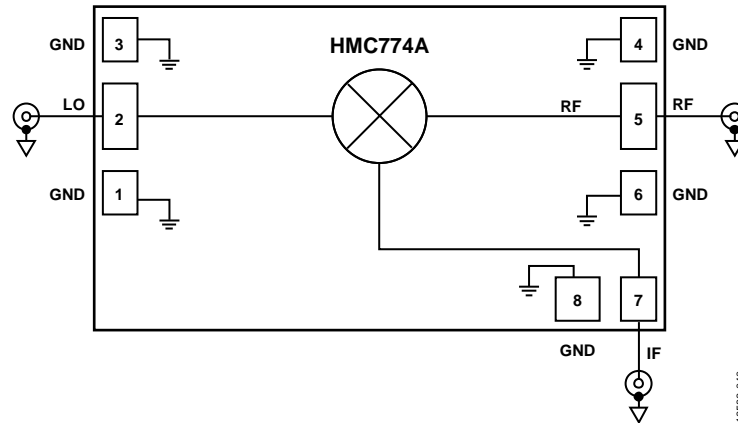

Figure 40. Typical Application Circuit

ASSEMBLY DIAGRAM

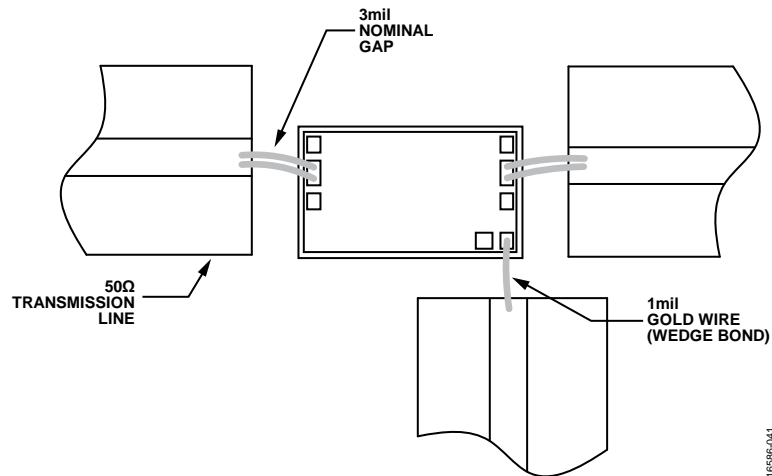

Figure 41. Assembly Diagram

MOUNTING AND BONDING TECHNIQUES FOR MILLIMETER WAVE GaAs MMICs

Attach the die directly to the ground plane eutectically or with conductive epoxy.

To bring RF to and from the chip, use 50 Ω microstrip transmission lines on 0.127 mm (0.005") thick alumina, thin film substrates (see Figure 42).

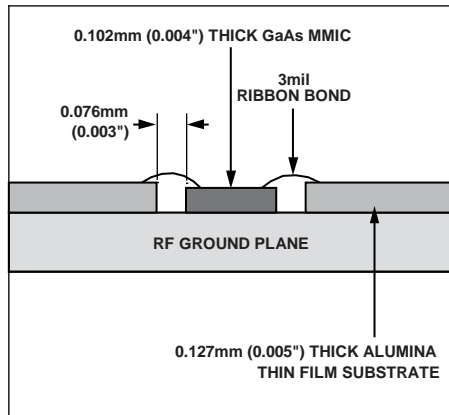

Figure 42. Routing RF Signals

If using 0.254 mm (0.010") thick alumina, thin film substrates, raise the die 0.150 mm (0.005") so that the surface of the die is coplanar with the surface of the substrate.

One way to accomplish this is to attach the 0.102 mm (0.004") thick die to a 0.150 mm (0.005") thick molybdenum heat spreader (moly-tab) which is then attached to the ground plane (see Figure 43).

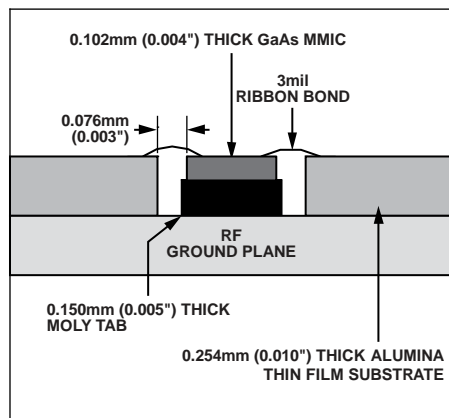

Figure 43. Routing RF Signals (Raised)

Microstrip substrates must be brought as close to the die as possible to minimize ribbon bond length. Typical die to substrate spacing is 0.076 mm (0.003"). Gold ribbon of 0.076 mm (0.003") width and minimal length <0.31 mm (<0.012") is recommended to minimize inductance on RF, LO, and IF ports.

Handling Precautions

To avoid permanent damage, adhere to the following precautions.

Storage

All bare die ship in either waffle or gel-based ESD protective containers, and then sealed in an ESD protective bag. After opening the sealed ESD protective bag, all die must be stored in a dry nitrogen environment.

Cleanliness

Handle the chips in a clean environment. Never use liquid cleaning systems to clean the chip.

Static Sensitivity

Follow ESD precautions to protect against ESD strikes.

Transients

Suppress instrument and bias supply transients while bias is applied. To minimize inductive pickup, use shielded signal and bias cables.

General Handling

Handle the chip on the edges only using a vacuum collet or with a sharp pair of bent tweezers. Because the surface of the chip has fragile air bridges, never touch the surface of the chip with a vacuum collet, tweezers, or fingers.

Mounting

The chip back is metalized and can be die mounted with gold/tin (AuSn) eutectic performs or with electrically conductive epoxy. The mounting surface must be clean and flat.

Eutectic Die Attach

It is best to use an 80% Au/20% Sn preform with a work surface temperature of 255°C and a tool temperature of 265°C. When applying hot 90% nitrogen (N)/10% hydrogen (H) gas, maintain a tool tip temperature at 290°C. Do not expose the chip to a temperature greater than 320°C for more than 20 sec. No more than 3 sec of scrubbing is required for attachment.

Epoxy Die Attach

Apply a minimum amount of epoxy to the mounting surface so that a thin epoxy fillet is observed around the perimeter of the chip after placing it into position. Cure the epoxy per the schedule provided by the manufacturer.

Wire Bonding

RF bonds made with 3 mil \times 0.5 mil gold ribbon are recommended for the RF ports. These bonds must be thermosonically bonded with a force of 40 g to 60 g. DC bonds of 0.025 mm (0.001") diameter, thermosonically bonded, are recommended. Create ball bonds with a force of 40 g to 50 g and wedge bonds with a force of 18 g to 22 g. Create all bonds with a nominal stage temperature of 150°C. Apply a minimum amount of ultrasonic energy to achieve reliable bonds. Keep all bonds as short as possible, less than 0.31 mm (0.012").

OUTLINE DIMENSIONS

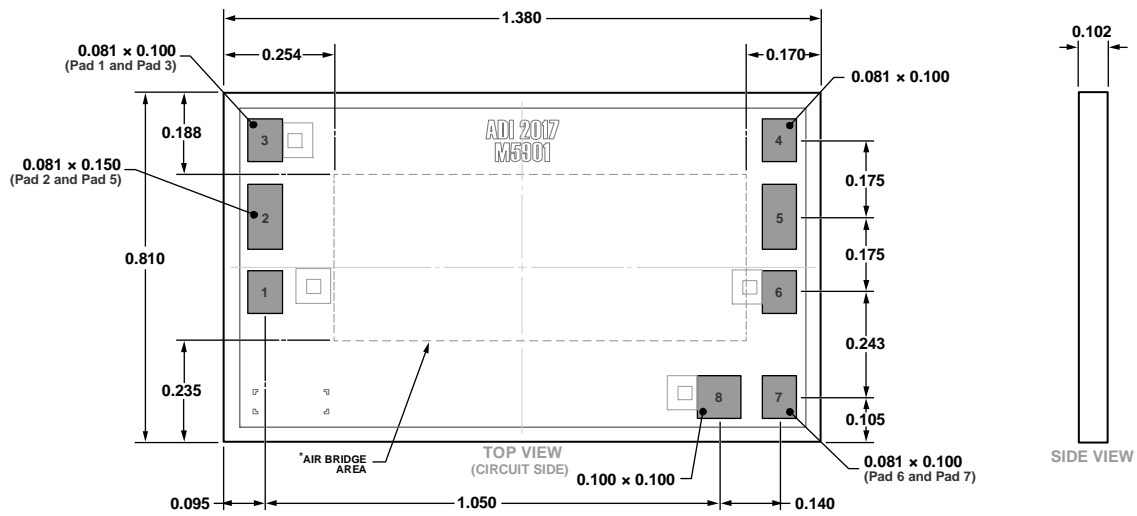

*This die utilizes fragile air bridges. Any pickup tools used must not contact this area.

Figure 44. 8-Pad Bare Die [CHIP]
(C-8-12)
Dimensions shown in millimeter

04-12-2018-A

ORDERING GUIDE

Model ¹	Temperature Range	Package Description	Package Option
HMC774A	-55°C to +85°C	8-Pad Bare Die [CHIP]	C-8-12
HMC774A-SX	-55°C to +85°C	8-Pad Bare Die [CHIP]	C-8-12

¹ The HMC774A and HMC774A-SX are RoHS Compliant Parts.



Компания «ЭлектроПласт» предлагает заключение долгосрочных отношений при поставках импортных электронных компонентов на взаимовыгодных условиях!

Наши преимущества:

- Оперативные поставки широкого спектра электронных компонентов отечественного и импортного производства напрямую от производителей и с крупнейших мировых складов;
- Поставка более 17-ти миллионов наименований электронных компонентов;
- Поставка сложных, дефицитных, либо снятых с производства позиций;
- Оперативные сроки поставки под заказ (от 5 рабочих дней);
- Экспресс доставка в любую точку России;
- Техническая поддержка проекта, помощь в подборе аналогов, поставка прототипов;
- Система менеджмента качества сертифицирована по Международному стандарту ISO 9001;
- Лицензия ФСБ на осуществление работ с использованием сведений, составляющих государственную тайну;
- Поставка специализированных компонентов (Xilinx, Altera, Analog Devices, Intersil, Interpoint, Microsemi, Aeroflex, Peregrine, Syfer, Eurofarad, Texas Instrument, Miteq, Cobham, E2V, MA-COM, Hittite, Mini-Circuits, General Dynamics и др.);

Помимо этого, одним из направлений компании «ЭлектроПласт» является направление «Источники питания». Мы предлагаем Вам помощь Конструкторского отдела:

- Подбор оптимального решения, техническое обоснование при выборе компонента;
- Подбор аналогов;
- Консультации по применению компонента;
- Поставка образцов и прототипов;
- Техническая поддержка проекта;
- Защита от снятия компонента с производства.



Как с нами связаться

Телефон: 8 (812) 309 58 32 (многоканальный)

Факс: 8 (812) 320-02-42

Электронная почта: org@eplast1.ru

Адрес: 198099, г. Санкт-Петербург, ул. Калинина, дом 2, корпус 4, литера А.