



STINGRAY™ SERIES



RoHS Compliant

Applications

- Distributed power architectures
- Wireless networks
- Access and optical network Equipment
- Enterprise Networks including Power over Ethernet (PoE)
- Latest generation IC's (DSP, FPGA, ASIC) and Microprocessor powered applications

Options

- Negative Remote On/Off logic (-1 option, preferred/standard)
- Surface Mount version (-S option)
- Auto-restart (-4 option, preferred/standard)
- Trimmed leads (-6 or -8 options)

Description

The ESTW025A0F series, Eighth-brick power modules are isolated dc-dc converters that can deliver up to 25A of output current and provide a precisely regulated output voltage over a wide range of input voltages ($V_{in} = 36 - 75V_{dc}$). The module achieves typical full load efficiency of 92% at 3.3V_{dc} output voltage. The open frame modules construction, available in both surface-mount and through-hole packaging, enable designers to develop cost- and space-efficient solutions.

Features

- Wide input voltage range: 36-75 V_{dc}
- Delivers up to 25A Output current
- Monotonic startup into prebiased load
- Output Voltage adjust: 80% to 110% of V_{o,nom}
- Remote sense
- Constant switching frequency
- Positive remote On/Off logic
- Input under voltage protection
- Output overcurrent and overvoltage protection
- Over-temperature protection
- Industry standard, DOSA compliant footprint
57.9mm x 22.8mm x 8.5mm
(2.28 in x 0.9 in x 0.335 in)
- Low profile height and reduced component skyline
- Suitable for cold wall cooling using suitable Gap Pad applied directly to top side of module
- High efficiency 92% at full load ($V_{in}=48V_{dc}$)
- No thermal derating up to 68°C, 1.0m/s (200 LFM)
- Wide operating temperature range (-40°C to 85°C)
- Compliant to RoHS EU Directive 2002/95/EC (-Z versions)
- Compliant to ROHS EU Directive 2002/95/EC with lead solder exemption (non-Z versions)
- UL* 60950-1, 2nd Ed. Recognized, CSA† C22.2 No. 60950-1-07 Certified, and VDE‡ (EN60950-1, 2nd Ed.) Licensed
- CE mark meets 2006/95/EC directive[§]
- Meets the voltage and current requirements for ETSI 300-132-2 and complies with and licensed for Basic insulation rating per EN60950-1
- 2250 V_{dc} Isolation tested in compliance with IEEE 802.3[¶] PoE standards
- ISO**9001 and ISO 14001 certified manufacturing facilities

* UL is a registered trademark of Underwriters Laboratories, Inc.

† CSA is a registered trademark of Canadian Standards Association.

‡ VDE is a trademark of Verband Deutscher Elektrotechniker e.V.

§ This product is intended for integration into end-user equipment. All of the required procedures of end-use equipment should be followed.

¶ IEEE and 802 are registered trademarks of the Institute of Electrical and Electronics Engineers, Incorporated.

** ISO is a registered trademark of the International Organization of Standards

Absolute Maximum Ratings

Stresses in excess of the absolute maximum ratings can cause permanent damage to the device. These are absolute stress ratings only, functional operation of the device is not implied at these or any other conditions in excess of those given in the operations sections of the data sheet. Exposure to absolute maximum ratings for extended periods can adversely affect the device reliability.

Parameter	Device	Symbol	Min	Max	Unit
Input Voltage					
Continuous	All	V_{IN}	-0.3	80	V_{dc}
Transient, operational (≤ 100 ms)	All	$V_{IN,trans}$	-0.3	100	V_{dc}
Operating Ambient Temperature	All	T_A	-40	85	$^{\circ}C$
Maximum Base-plate Operating Temperature (see Thermal Considerations section)	-18H, H	T_C	-40	110	$^{\circ}C$
Storage Temperature	All	T_{stg}	-55	125	$^{\circ}C$
I/O Isolation voltage (100% factory Hi-Pot tested)	All	—	—	2250	V_{dc}

Electrical Specifications

Unless otherwise indicated, specifications apply over all operating input voltage, resistive load, and temperature conditions.

Parameter	Device	Symbol	Min	Typ	Max	Unit
Operating Input Voltage	All	V_{IN}	36	48	75	V_{dc}
Maximum Input Current ($V_{IN} = V_{IN, min}$ to $V_{IN, max}$; $I_O = I_{O, max}$)	All	$I_{IN, max}$			2.7	A_{dc}
Input No Load Current ($V_{IN} = V_{IN, nom}$; $I_O = 0$, module enabled)	All	$I_{IN, No load}$		50		mA
Input Stand-by Current ($V_{IN} = V_{IN, nom}$, module disabled)	All	$I_{IN, stand-by}$		6	8	mA
Inrush Transient	All	I^2t			1	A^2s
Input Reflected Ripple Current, peak-to-peak (5Hz to 20MHz, 1 μ H source impedance; $V_{IN, min}$ to $V_{IN, max}$, $I_O = I_{Omax}$; See Test configuration section)	All			30		mA_{p-p}
Input Ripple Rejection (120Hz)	All			50		dB

CAUTION: This power module is not internally fused. An input line fuse must always be used.

This power module can be used in a wide variety of applications, ranging from simple standalone operation to an integrated part of sophisticated power architectures. To preserve maximum flexibility, internal fusing is not included, however, to achieve maximum safety and system protection, always use an input line fuse. The safety agencies require a fast-acting fuse with a maximum rating of 5 A (see Safety Considerations section). Based on the information provided in this data sheet on inrush energy and maximum dc input current, the same type of fuse with a lower rating can be used. Refer to the fuse manufacturer's data sheet for further information.

Electrical Specifications (continued)

Parameter	Device	Symbol	Min	Typ	Max	Unit
Nominal Output Voltage Set-point $V_{IN}=V_{IN, nom}, I_O=I_{O, max}, T_A=25^{\circ}C$	All	$V_{O, set}$	3.250	3.300	3.350	V _{dc}
Output Voltage (Over all operating input voltage, resistive load, and temperature conditions until end of life)	All	V_O	3.200	—	3.400	V _{dc}
Output Regulation Line ($V_{IN}=V_{IN, min}$ to $V_{IN, max}$) Load ($I_O=I_{O, min}$ to $I_{O, max}$) Temperature ($T_{ref}=T_{A, min}$ to $T_{A, max}$)	All All All	— — —	— — —	— — ± 0.2	± 0.1 10	% $V_{O, set}$ mV % $V_{O, set}$
Output Ripple and Noise on nominal output ($C_O=1\mu F, ceramic+10\mu F, tantalum, V_{IN}=V_{IN, nom}, I_O=I_{O, max}, T_A=T_{A, min}$ to $T_{A, max}$) RMS (5Hz to 20MHz bandwidth) Peak-to-Peak (5Hz to 20MHz bandwidth)	All All	— —	— —	8 40	20 75	mV _{rms} mV _{pk-pk}
External Capacitance ¹	All	$C_{O, max}$	0	—	20,000	μF
Output Current	All	I_O	0	—	25.0	A _{dc}
Output Current Limit Inception (Hiccup Mode) ($V_O=90\%$ of $V_{O, set}$)	All	$I_{O, lim}$	26.3	29	32.5	A _{dc}
Output Short-Circuit Current ($V_O \leq 250mV$) (Hiccup Mode)	All	$I_{O, s/c}$	—	1.6	—	A _{rms}
Efficiency $V_{IN}=V_{IN, nom}, T_A=25^{\circ}C, I_O=I_{O, max}, V_O=V_{O, set}$ $V_{IN}=V_{IN, nom}, T_A=25^{\circ}C, I_O=10A, V_O=V_{O, set}$ $V_{IN}=V_{IN, nom}, T_A=25^{\circ}C, I_O=5A, V_O=V_{O, set}$	All All All	η η η	91.0 91.0 85.5	92.0 92.0 87.0	— — —	% % %
Switching Frequency	All	f_{sw}	—	355	—	kHz
Dynamic Load Response ($C_O=1\mu F, ceramic+220\mu F, tantalum, dI_O/dt=0.1A/\mu s; V_{IN}=48V; T_A=25^{\circ}C$) Load Change from $I_O=50\%$ to 75% or 25% to 50% of $I_{O, max}$ Peak Deviation Settling Time ($V_O < 10\%$ peak deviation)	All All	V_{pk} t_s	— —	127 200	— —	mV μs

1. See Note 2 under Feature Specifications.

Isolation Specifications

Parameter	Device	Symbol	Min	Typ	Max	Unit
Isolation Capacitance	All	C_{iso}	—	1000	—	pF
Isolation Resistance	All	R_{iso}	—	30	—	M Ω
I/O Isolation Voltage (100% factory Hi-pot tested)	All	All	—	—	2250	V _{dc}

General Specifications

Parameter	Device	Symbol	Min	Typ	Max	Unit
Calculated Reliability based upon Telcordia SR-332 Issue 2: Method I Case 3 ($I_O=80\%I_{O, max}, T_A=40^{\circ}C, airflow = 200 lfm, 90\%$ confidence)	All	FIT	—	229.4	—	10 ⁹ /Hours
	All	MTBF	—	4,359,904	—	Hours
Weight (Open Frame)	All	—	—	22 (0.78)	—	g(oz)
Weight (with Heatplate)	All	—	—	35 (1.23)	—	g(oz)

Feature Specifications

Unless otherwise indicated, specifications apply over all operating input voltage, resistive load, and temperature conditions. See Feature Descriptions for additional information.

Parameter	Device	Symbol	Min	Typ	Max	Unit
Remote On/Off Signal Interface ($V_{IN}=V_{IN, min}$ to $V_{IN, max}$; open collector or equivalent, Signal referenced to V_{IN} -terminal) Negative Logic: device code suffix "1" Logic Low = module On, Logic High = module Off Positive Logic: No device code suffix required Logic Low = module Off, Logic High = module On						
Logic Low - Remote On/Off Current	All	$I_{on/off}$	—	—	0.15	mA
Logic Low - On/Off Voltage	All	$V_{on/off}$	-0.7	—	0.6	V _{dc}
Logic High Voltage – (Typ = Open Collector)	All	$V_{on/off}$	2.4	—	15.0	V _{dc}
Logic High maximum allowable leakage current	All	$I_{on/off}$	—	—	25	μA
Turn-On Delay ¹ and Rise Times ($I_O=I_{O, max}$, $V_{IN}=V_{IN, nom}$, $T_A = 25^\circ\text{C}$) Case 1: Input power is applied for >1 second and then the On/Off input is set to ON (T_{delay} = time from instant On/Off signal is ON until $V_O = 10\%$ of $V_{O, set}$) Case 2: On/Off input is set to Logic Low (Module ON) and then input power is applied (T_{delay} = time at which $V_{IN} = V_{IN, min}$ until $V_O=10\%$ of $V_{O, set}$) Output voltage Rise time (time for V_O to rise from 10% of $V_{O, set}$ to 90% of $V_{O, set}$)						
	All	T_{delay}	—	12	—	msec
	All	T_{delay}	—	20	—	msec
	All	T_{rise}	—	4	—	msec
Output voltage overshoot – Startup $I_O= I_{O, max}$; $V_{IN}=V_{IN, min}$ to $V_{IN, max}$; $T_A = 25^\circ\text{C}$	All			—	5	% $V_{O, set}$
Prebias Output Load Performance:						
Output Start up characteristic	All			Monotonic		
Back Bias current drawn from output (Module Enabled)	All			-15		mA _{dc}
Remote Sense Range	All	V_{SENSE}			10	% $V_{O, set}$
Output Voltage Adjustment Range	All		-20		+10	% $V_{O, set}$
Output Overvoltage Protection ($C_O=470\mu\text{F}$) ²	All	$V_{O, limit}$	3.9		5.1	V _{dc}
Overtemperature Protection – Hiccup Auto Restart	All	T_{ref}	—	125	—	°C
Input Undervoltage Lockout	All	V_{UVLO}				
Turn-on Threshold			—	34.0	35.5	V _{dc}
Turn-off Threshold			30.5	32.0	—	V _{dc}
Hysteresis			1.0	2.0	—	V _{dc}

- The module has an adaptable extended Turn-On Delay interval, T_{delay} , of 25mS. The extended T_{delay} will occur when the module restarts following the rapid cycling of V_{in} from normal levels to less than the Input Undervoltage Lockout (which causes module shutdown), and then back to normal.
- The module requires a minimum of 470 μF external output capacitor to prevent shutdown during full load to no load transients and to avoid exceeding the OVP maximum limits during startup into open loop fault conditions.

Characteristic Curves

The following figures provide typical characteristics for the ESTW025A0F (3.3V, 25A) at 25°C. The figures are identical for either positive or negative remote On/Off logic.

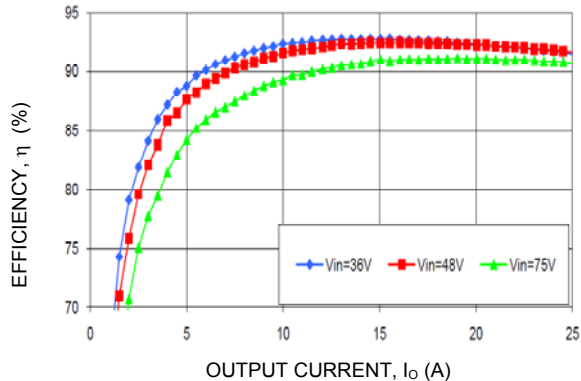

Figure 1. Converter Efficiency versus Output Current.

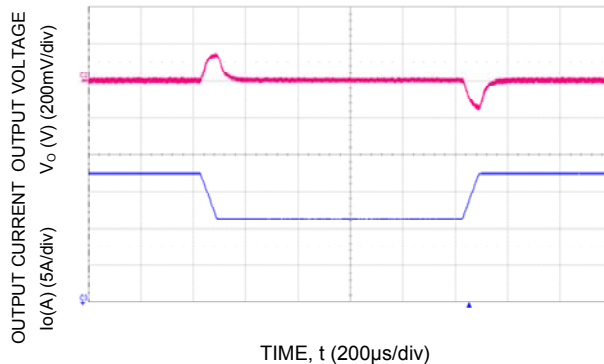

Figure 4. Transient Response to 0.1A/μS Dynamic Load Change from 50% to 75% to 50% of full load.

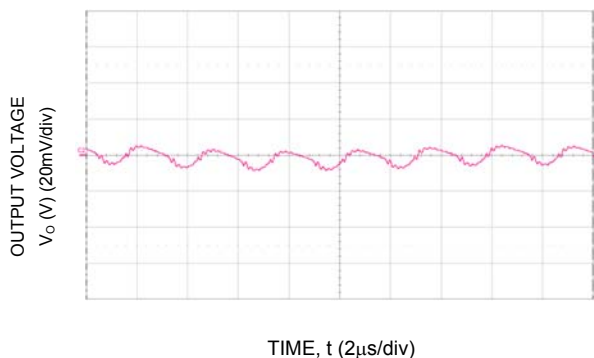

Figure 2. Typical output ripple and noise ($V_{IN} = V_{IN,NOM}$, $I_o = I_{o,max}$).

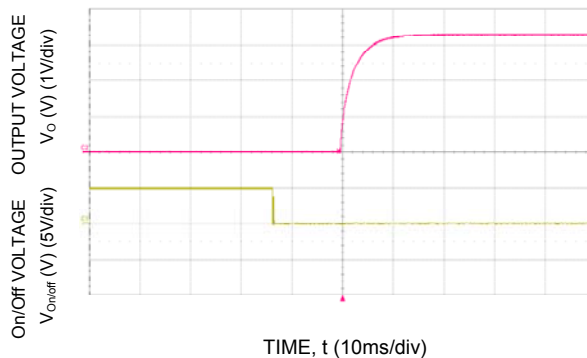

Figure 5. Typical Start-up Using Remote On/Off, negative logic version shown ($V_{IN} = V_{IN,NOM}$, $I_o = I_{o,max}$).

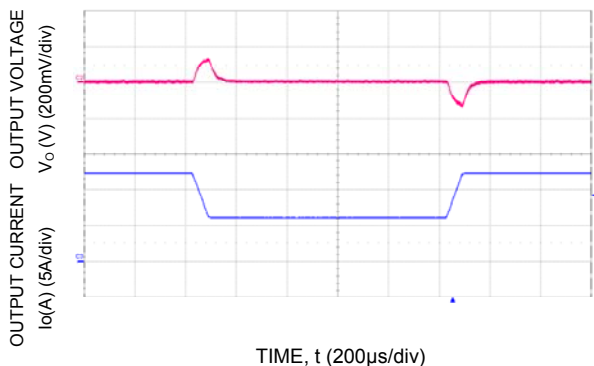

Figure 3. Transient Response to 0.1A/μS Dynamic Load Change from 25% to 50% to 25% of full load.

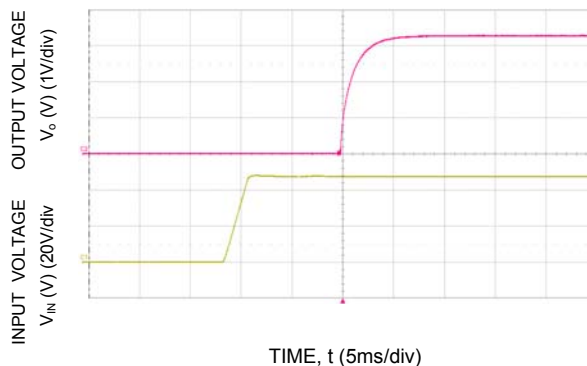
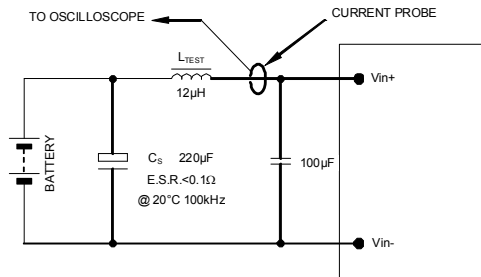

Figure 6. Typical Start-up Using Input Voltage ($V_{IN} = V_{IN,NOM}$, $I_o = I_{o,max}$).

Test Configurations



NOTE: Measure input reflected ripple current with a simulated source inductance (L_{TEST}) of 12µH. Capacitor C_S offsets possible battery impedance. Measure current as shown above.

Figure 7. Input Reflected Ripple Current Test Setup.

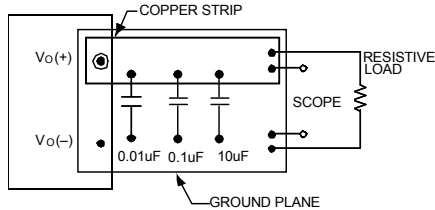

NOTE: All voltage measurements to be taken at the module terminals, as shown above. If sockets are used then Kelvin connections are required at the module terminals to avoid measurement errors due to socket contact resistance.

Figure 8. Output Ripple and Noise Test Setup.

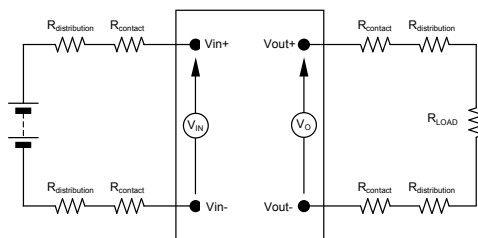

NOTE: All voltage measurements to be taken at the module terminals, as shown above. If sockets are used then Kelvin connections are required at the module terminals to avoid measurement errors due to socket contact resistance.

Figure 9. Output Voltage and Efficiency Test Setup.

$$\text{Efficiency } \eta = \frac{V_O \cdot I_O}{V_{IN} \cdot I_{IN}} \times 100 \%$$

Design Considerations

Input Filtering

The power module should be connected to a low ac-impedance source. Highly inductive source impedance can affect the stability of the power module. For the test configuration in Figure 7 a 100µF electrolytic capacitor (ESR<0.7Ω at 100kHz), mounted close to the power module helps ensure the stability of the unit. Consult the factory for further application guidelines.

Safety Considerations

For safety-agency approval of the system in which the power module is used, the power module must be installed in compliance with the spacing and separation requirements of the end-use safety agency standard, i.e. UL60950-1, CSA C22.2 No.60950-1, and VDE0805-1(IEC60950-1).

If the input source is non-SELV (ELV or a hazardous voltage greater than 60 Vdc and less than or equal to 75Vdc), for the module's output to be considered as meeting the requirements for safety extra-low voltage (SELV), all of the following must be true:

- The input source is to be provided with reinforced insulation from any other hazardous voltages, including the ac mains.
- One V_{IN} pin and one V_{OUT} pin are to be grounded, or both the input and output pins are to be kept floating.
- The input pins of the module are not operator accessible.
- Another SELV reliability test is conducted on the whole system (combination of supply source and subject module), as required by the safety agencies, to verify that under a single fault, hazardous voltages do not appear at the module's output.

Note: Do not ground either of the input pins of the module without grounding one of the output pins. This may allow a non-SELV voltage to appear between the output pins and ground.

The power module has extra-low voltage (ELV) outputs when all inputs are ELV.

All flammable materials used in the manufacturing of these modules are rated 94V-0, or tested to the UL60950 A.2 for reduced thickness.

For input voltages exceeding 60 Vdc but less than or equal to 75 Vdc, these converters have been evaluated to the applicable requirements of BASIC INSULATION between secondary DC MAINS DISTRIBUTION input (classified as TNV-2 in Europe) and unearthed SELV outputs.

The input to these units is to be provided with a maximum 5 A fast-acting fuse in the ungrounded lead.

Feature Description

Remote On/Off

Two remote on/off options are available. Positive logic turns the module on during a logic high voltage on the ON/OFF pin, and off during a logic low. Negative logic remote On/Off, device code suffix “1”, turns the module off during a logic high and on during a logic low.

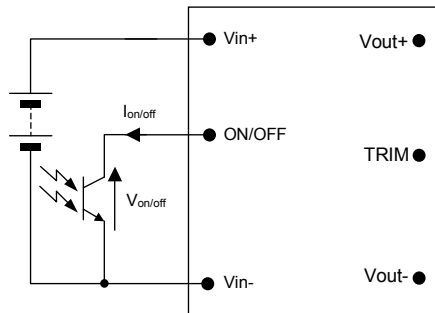

Figure 10. Remote On/Off Implementation.

To turn the power module on and off, the user must supply a switch (open collector or equivalent) to control the voltage ($V_{on/off}$) between the ON/OFF terminal and the $V_{IN(-)}$ terminal (see Figure 10). Logic low is $0V \leq V_{on/off} \leq 1.2V$. The maximum $I_{on/off}$ during a logic low is 1mA, the switch should maintain a logic low level while sinking this current.

During a logic high, the typical maximum $V_{on/off}$ generated by the module is 15V, and the maximum allowable leakage current at $V_{on/off} = 5V$ is $1\mu A$.

If not using the remote on/off feature:

For positive logic, leave the ON/OFF pin open.

For negative logic, short the ON/OFF pin to $V_{IN(-)}$.

Remote Sense

Remote sense minimizes the effects of distribution losses by regulating the voltage at the remote-sense connections (See Figure 11). The voltage between the remote-sense pins and the output terminals must not exceed the output voltage sense range given in the Feature Specifications table:

$$[V_o(+)-V_o(-)] - [SENSE(+)-SENSE(-)] \leq 0.5V$$

Although the output voltage can be increased by both the remote sense and by the trim, the maximum increase for the output voltage is not the sum of both. The maximum increase is the larger of either the remote sense or the trim.

The amount of power delivered by the module is defined as the voltage at the output terminals multiplied by the output current. When using remote sense and trim, the output voltage of the module can

be increased, which at the same output current would increase the power output of the module. Care should be taken to ensure that the maximum output power of the module remains at or below the maximum rated power (Maximum rated power = $V_{o,set} \times I_{o,max}$).

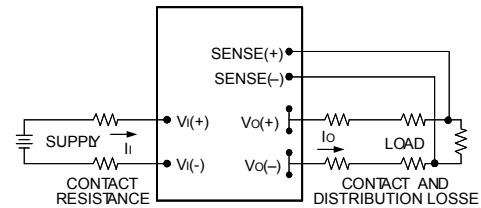

Figure 11. Circuit Configuration for remote sense .

Input Undervoltage Lockout

At input voltages below the input undervoltage lockout limit, the module operation is disabled. The module will only begin to operate once the input voltage is raised above the undervoltage lockout turn-on threshold, $V_{UV/ON}$.

Once operating, the module will continue to operate until the input voltage is taken below the undervoltage turn-off threshold, $V_{UV/OFF}$.

Overtemperature Protection

To provide protection under certain fault conditions, the unit is equipped with a thermal shutdown circuit. The unit will shutdown if the thermal reference point T_{ref} (Figure 13), exceeds $125^{\circ}C$ (typical), but the thermal shutdown is not intended as a guarantee that the unit will survive temperatures beyond its rating. The module can be restarted by cycling the dc input power for at least one second or by toggling the remote on/off signal for at least one second. If the auto-restart option (4) is ordered, the module will automatically restart upon cool-down to a safe temperature.

Output Overvoltage Protection

The output over voltage protection scheme of the modules has an independent over voltage loop to prevent single point of failure. This protection feature latches in the event of over voltage across the output.

Cycling the on/off pin or input voltage resets the latching protection feature. If the auto-restart option (4) is ordered, the module will automatically restart upon an internally programmed time elapsing.

Overcurrent Protection

To provide protection in a fault (output overload) condition, the unit is equipped with internal current limiting circuitry and can endure current limiting continuously. At the point of current limit inception, the unit enters hiccup mode. If the unit is

Feature Descriptions (continued)

not configured with auto-restart, then it will latch off following the over current condition. The module can be restarted by cycling the dc input power for at least one second or by toggling the remote on/off signal for at least one second. If the unit is configured with the auto-restart option (4), it will remain in the hiccup mode as long as the overcurrent condition exists; it operates normally, once the output current is brought back into its specified range. The average output current during hiccup is 10% $I_{O, max}$.

Output Voltage Programming

Trimming allows the output voltage set point to be increased or decreased, this is accomplished by connecting an external resistor between the TRIM pin and either the $V_O(+)$ pin or the $V_O(-)$ pin.

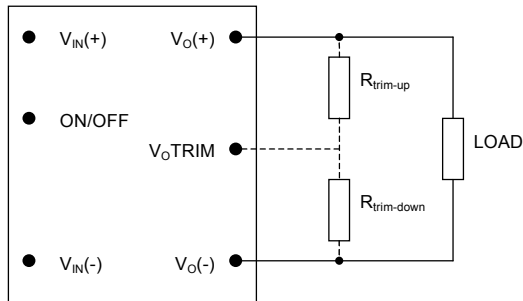

Figure 12. Circuit Configuration to Trim Output Voltage.

Connecting an external resistor ($R_{trim-down}$) between the TRIM pin and the $V_O(-)$ (or Sense(-)) pin decreases the output voltage set point. To maintain set point accuracy, the trim resistor tolerance should be $\pm 1.0\%$.

The following equation determines the required external resistor value to obtain a percentage output voltage change of $\Delta\%$

$$R_{trim-down} = \left[\frac{511}{\Delta\%} - 10.22 \right] K\Omega$$

Where
$$\Delta\% = \left(\frac{V_{o,set} - V_{desired}}{V_{o,set}} \right) \times 100$$

For example, to trim-down the output voltage of the module by 8% to 3.036V, $R_{trim-down}$ is calculated as follows:

$$\begin{aligned} \Delta\% &= 8 \\ R_{trim-down} &= \left[\frac{511}{8} - 10.22 \right] K\Omega \\ R_{trim-down} &= 53.655 K\Omega \end{aligned}$$

Connecting an external resistor ($R_{trim-up}$) between the TRIM pin and the $V_O(+)$ (or Sense (+)) pin increases

the output voltage set point. The following equation determines the required external resistor value to obtain a percentage output voltage change of $\Delta\%$:

$$R_{trim-up} = \left[\frac{5.11 \times V_{o,set} \times (100 + \Delta\%)}{1.225 \times \Delta\%} - \frac{511}{\Delta\%} - 10.22 \right] K\Omega$$

Where
$$\Delta\% = \left(\frac{V_{desired} - V_{o,set}}{V_{o,set}} \right) \times 100$$

For example, to trim-up the output voltage of the module by 5% to 3.465V, $R_{trim-up}$ is calculated as follows:

$$\begin{aligned} \Delta\% &= 5 \\ R_{trim-up} &= \left[\frac{5.11 \times 3.3 \times (100 + 5)}{1.225 \times 5} - \frac{511}{5} - 10.22 \right] K\Omega \\ R_{trim-up} &= 176.7 K\Omega \end{aligned}$$

The voltage between the $V_O(+)$ and $V_O(-)$ terminals must not exceed the minimum output overvoltage protection value shown in the Feature Specifications table. This limit includes any increase in voltage due to remote-sense compensation and output voltage set-point adjustment trim.

Although the output voltage can be increased by both the remote sense and by the trim, the maximum increase for the output voltage is not the sum of both. The maximum increase is the larger of either the remote sense or the trim. The amount of power delivered by the module is defined as the voltage at the output terminals multiplied by the output current. When using remote sense and trim, the output voltage of the module can be increased, which at the same output current would increase the power output of the module. Care should be taken to ensure that the maximum output power of the module remains at or below the maximum rated power (Maximum rated power = $V_{O,set} \times I_{O,max}$).

Thermal Considerations

The power modules operate in a variety of thermal environments; however, sufficient cooling should be provided to help ensure reliable operation.

Considerations include ambient temperature, airflow, module power dissipation, and the need for increased reliability. A reduction in the operating temperature of the module will result in an increase in reliability. The thermal data presented here is based on physical measurements taken in a wind tunnel.

The thermal reference points, T_{ref1} , T_{ref2} and T_{ref3} used in the specifications for open frame modules are shown in Figures 13a and 13b. For reliable operation these temperatures should not exceed 125°C, 110°C and 105°C respectively.

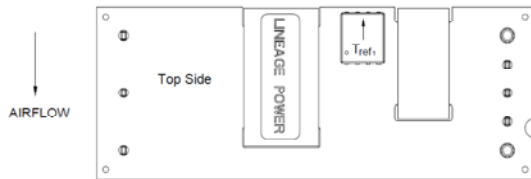

Figure 13a. T_{ref1} Temperature Measurement Location for Open Frame Module.

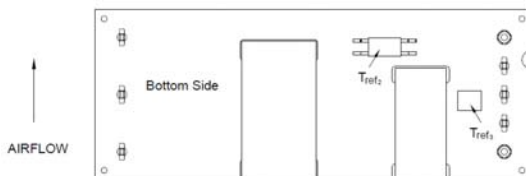

Figure 13b. T_{ref2} and T_{ref3} Temperature Measurement Locations for Open Frame Module.

The thermal reference point, T_{ref} , used in the specifications for modules with heatplate is shown in Figure 14. For reliable operation this temperature should not exceed 110°C.

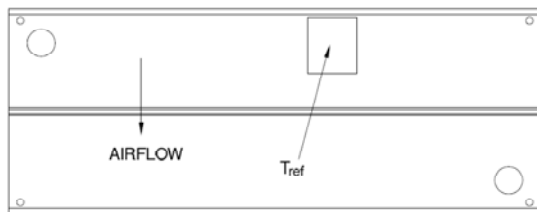

Figure 14. T_{ref} Temperature Measurement Location for Module with Heatplate.

Heat Transfer via Convection

Increased airflow over the module enhances the heat transfer via convection. Derating curves, showing the maximum output current that can be delivered by each module versus local ambient temperature (T_A)

for natural convection and up to 2.0 m/s (400 ft./min) forced airflow, are shown in Figure 15.

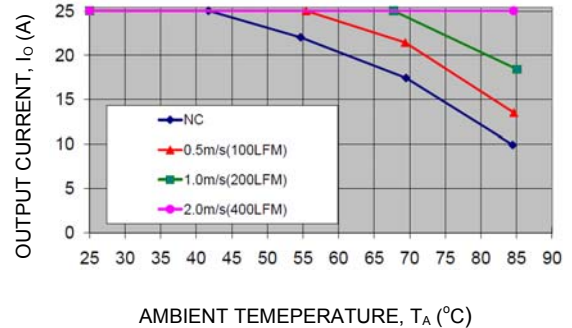

Figure 15. Output Current Derating for the Open Frame Module; Airflow in the Transverse Direction from $V_{out}(+)$ to $V_{out}(-)$; $V_{in}=48V$.

Heat Transfer via Conduction

The module can also be used in a sealed environment with cooling via conduction from the module's top surface through a gap pad material to a cold wall, as shown in Figure 16. The output current derating versus cold wall temperature, when using a gap pad such as Bergquist GP2500S20, is shown in Figure 17.

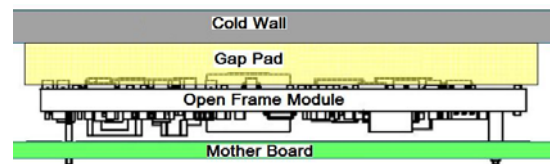

Figure 16. Cold Wall Mounting

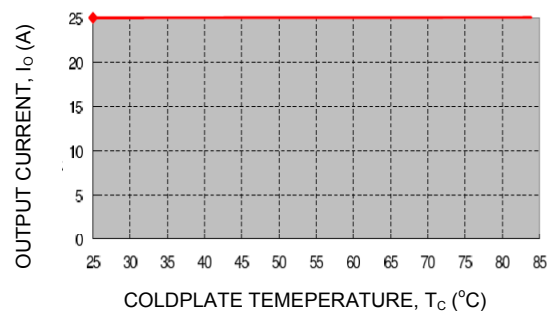

Figure 17. Derated Output Current versus Cold Wall Temperature with local ambient temperature around module at 85°C; $V_{in}=48V$.

Please refer to the Application Note "Thermal Characterization Process For Open-Frame Board-Mounted Power Modules" for a detailed discussion of thermal aspects including maximum device temperatures.

Surface Mount Information

Pick and Place

The ESTW025A0F modules use an open frame construction and are designed for a fully automated assembly process. The modules are fitted with a label designed to provide a large surface area for pick and place operations. The label meets all the requirements for surface mount processing, as well as safety standards, and is able to withstand reflow temperatures of up to 300°C. The label also carries product information such as product code, serial number and the location of manufacture.

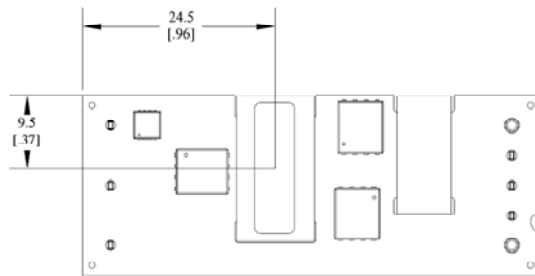

Figure 18. Pick and Place Location.

Nozzle Recommendations

The module weight has been kept to a minimum by using open frame construction. Even so, these modules have a relatively large mass when compared to conventional SMT components. Variables such as nozzle size, tip style, vacuum pressure and placement speed should be considered to optimize this process. The minimum recommended nozzle diameter for reliable operation is 6mm. The maximum nozzle outer diameter, which will safely fit within the allowable component spacing, is 9 mm.

Oblong or oval nozzles up to 11 x 9 mm may also be used within the space available.

Tin Lead Soldering

The ESTW025A0F power modules are lead free modules and can be soldered either in a lead-free solder process or in a conventional Tin/Lead (Sn/Pb) process. It is recommended that the customer review data sheets in order to customize the solder reflow profile for each application board assembly. The following instructions must be observed when soldering these units. Failure to observe these instructions may result in the failure of or cause damage to the modules, and can adversely affect long-term reliability.

In a conventional Tin/Lead (Sn/Pb) solder process peak reflow temperatures are limited to less than 235°C. Typically, the eutectic solder melts at 183°C, wets the land, and subsequently wicks the device connection. Sufficient time must be allowed to fuse

the plating on the connection to ensure a reliable solder joint. There are several types of SMT reflow technologies currently used in the industry. These surface mount power modules can be reliably soldered using natural forced convection, IR (radiant infrared), or a combination of convection/IR. For reliable soldering the solder reflow profile should be established by accurately measuring the modules CP connector temperatures.

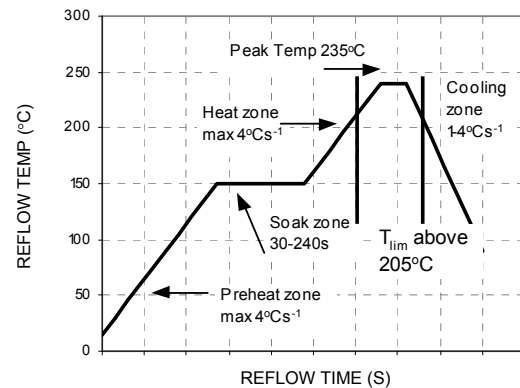

Figure 19. Reflow Profile for Tin/Lead (Sn/Pb) process.

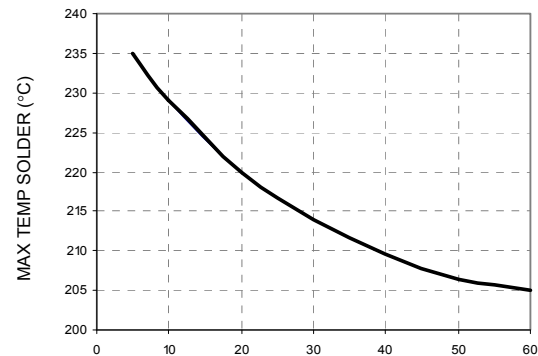

Figure 20. Time Limit Curve Above 205°C for Tin/Lead (Sn/Pb) process

Lead Free Soldering

The –Z version of the ESTW025A0F modules are lead-free (Pb-free) and RoHS compliant and are both forward and backward compatible in a Pb-free and a SnPb soldering process. Failure to observe the instructions below may result in the failure of or cause damage to the modules and can adversely affect long-term reliability.

Reflow Soldering Information

The surface mountable modules in the ESTW025A0F-S family use our newest SMT

Surface Mount Information (continued)

technology called “Column Pin” (CP) connectors. Figure 19 shows the new CP connector before and after reflow soldering onto the end-board assembly.

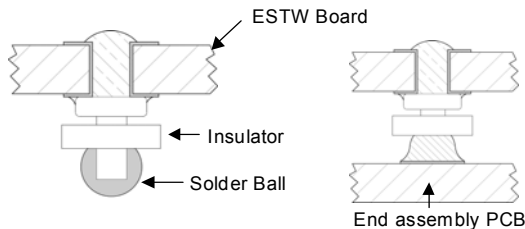

Figure 21. Column Pin Connector Before and After Reflow Soldering .

The CP is constructed from a solid copper pin with an integral solder ball attached, which is composed of tin/lead (Sn₆₃/Pb₃₇) solder for non-Z codes, or Sn/Ag_{3.8}/Cu_{0.7} (SAC) solder for –Z codes. The CP connector design is able to compensate for large amounts of co-planarity and still ensure a reliable SMT solder joint. Typically, the eutectic solder melts at 183°C (Sn/Pb solder) or 217–218 °C (SAC solder), wets the land, and subsequently wicks the device connection. Sufficient time must be allowed to fuse the plating on the connection to ensure a reliable solder joint. There are several types of SMT reflow technologies currently used in the industry. These surface mount power modules can be reliably soldered using natural forced convection, IR (radiant infrared), or a combination of convection/IR.

Pb-free Reflow Profile

Power Systems will comply with J-STD-020 Rev. C (Moisture/Reflow Sensitivity Classification for Nonhermetic Solid State Surface Mount Devices) for both Pb-free solder profiles and MSL classification procedures. This standard provides a recommended forced-air-convection reflow profile based on the volume and thickness of the package (table 4-2). The suggested Pb-free solder paste is Sn/Ag/Cu (SAC). The recommended linear reflow profile using Sn/Ag/Cu solder is shown in Figure 22.

MSL Rating

The ESTW025A0F modules have a MSL rating of 2a.

Storage and Handling

The recommended storage environment and handling procedures for moisture-sensitive surface mount packages is detailed in J-STD-033 Rev. A (Handling, Packing, Shipping and Use of Moisture/Reflow Sensitive Surface Mount Devices). Moisture barrier bags (MBB) with desiccant are required for MSL ratings of 2 or greater. These sealed packages

should not be broken until time of use. Once the original package is broken, the floor life of the product at conditions of ≤ 30°C and 60% relative humidity varies according to the MSL rating (see J-STD-033A). The shelf life for dry packed SMT packages will be a minimum of 12 months from the bag seal date, when stored at the following conditions: < 40° C, < 90% relative humidity.

Post Solder Cleaning and Drying Considerations

Post solder cleaning is usually the final circuit board assembly process prior to electrical board testing. The result of inadequate cleaning and drying can affect both the reliability of a power module and the testability of the finished circuit board assembly. For guidance on appropriate soldering, cleaning and drying procedures, refer to Lineage Power *Board Mounted Power Modules: Soldering and Cleaning* Application Note (AN04-001).

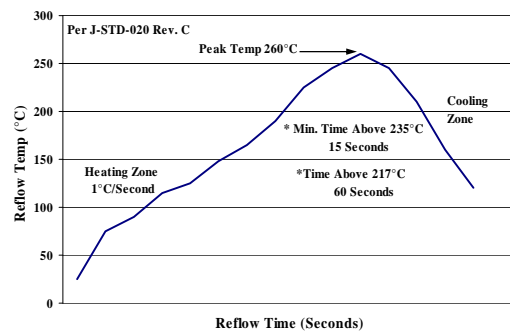

Figure 22. Recommended linear reflow profile using Sn/Ag/Cu solder.

Through-Hole Lead-Free Soldering Information

The RoHS-compliant through-hole products use the SAC (Sn/Ag/Cu) Pb-free solder and RoHS-compliant components. They are designed to be processed through single or dual wave soldering machines. The pins have a RoHS-compliant finish that is compatible with both Pb and Pb-free wave soldering processes. A maximum preheat rate of 3°C/s is suggested. The wave preheat process should be such that the temperature of the power module board is kept below 210°C. For Pb solder, the recommended pot temperature is 260°C, while the Pb-free solder pot is 270°C max. Not all RoHS-compliant through-hole products can be processed with paste-through-hole Pb or Pb-free reflow process. If additional information is needed, please consult with your Lineage Power representative for more details.

EMC Considerations

The filter circuit schematic and plots in Figure 23 shows a suggested configuration as tested to meet the conducted emission limits of EN55022 Class B.

Note: Customer is ultimately responsible for the proper selection, component rating and verification of the suggested parts based on the end application.

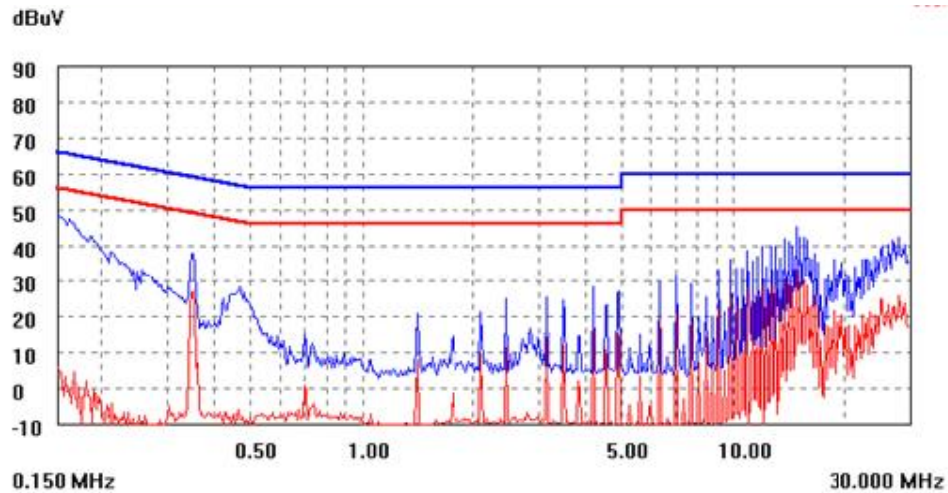
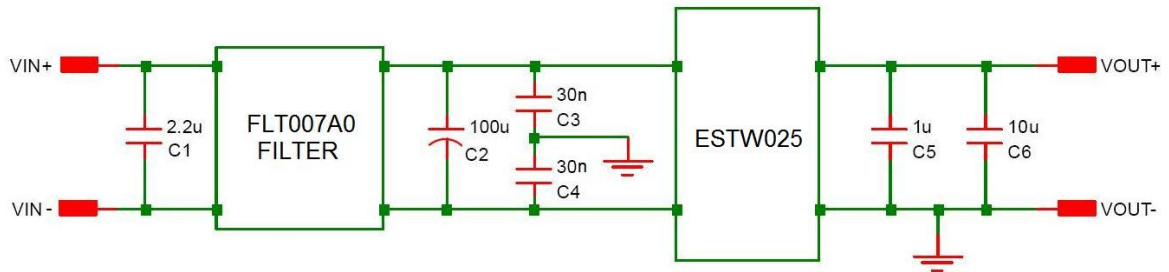

Figure 23. EMC Considerations

For further information on designing for EMC compliance, please refer to the FLT007A0 data sheet (DS05-028).

Mechanical Outline for Through-Hole Module

Dimensions are in millimeters and [inches].

Tolerances: x.x mm ± 0.5 mm [x.xx in. ± 0.02 in.] (Unless otherwise indicated)

x.xx mm ± 0.25 mm [x.xxx in. ± 0.010 in.]

*Top side label includes Lineage Power name, product designation and date code.

Top View*

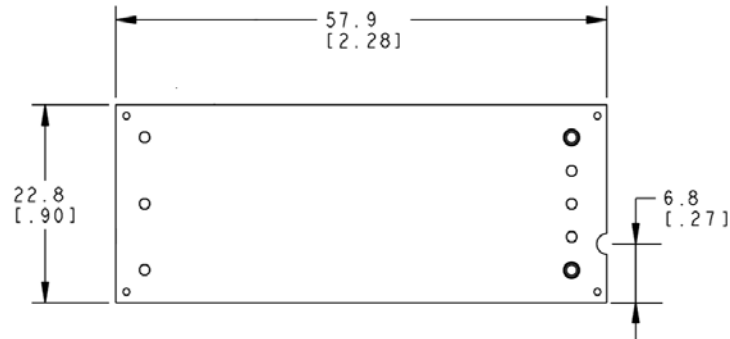

Side View

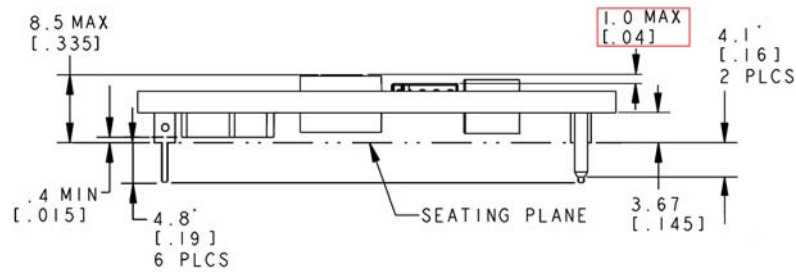

*For optional pin lengths, see Table 2, Device Options

Bottom View

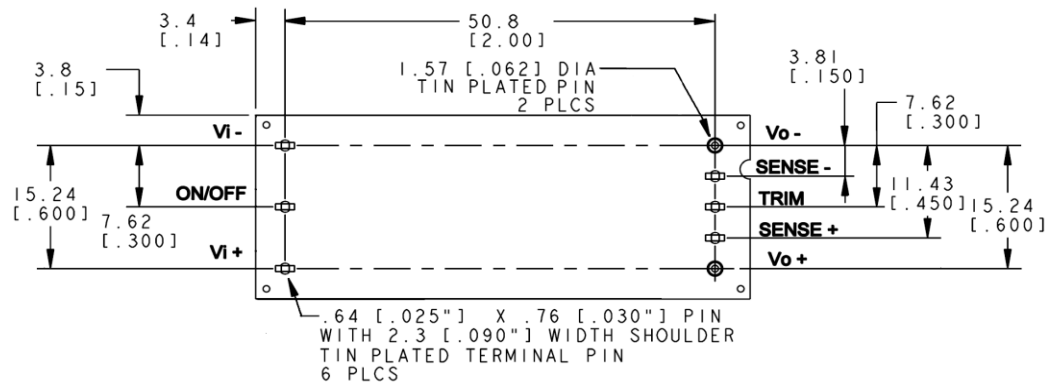

Pin	Function
1	Vi(+)
2	ON/OFF
3	Vi(-)
4	Vo(-)
5	SENSE(-)
6	TRIM
7	SENSE(+)
8	Vo(+)

Mechanical Outline for Surface Mount Module

Dimensions are in millimeters and [inches].
Tolerances: x.x mm ± 0.5 mm [x.xx in. ± 0.02 in.] (Unless otherwise indicated)
x.xx mm ± 0.25 mm [x.xxx in. ± 0.010 in.]

* Top side label includes Lineage Power name, product designation and date code.

Top View*

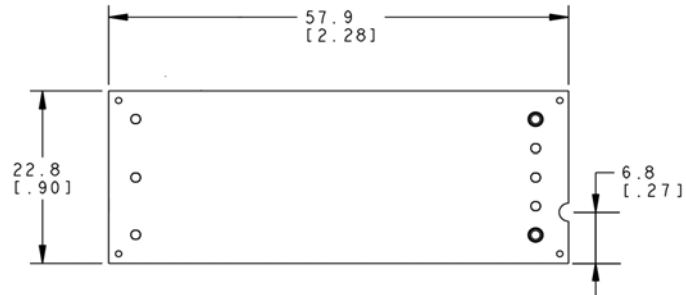

Side View

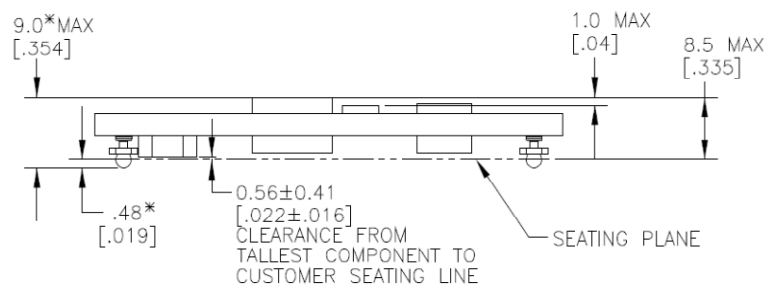

* MIN CLEARANCE AND MODULE HEIGHT IS TO TIP OF SOLDER BALL (UNSOLDERED) CLEARANCE WILL REDUCE WHEN SOLDER BALL IS REFLOWED. KEEP OUT AREAS ARE REQUIRED UNDER MODULE.

Bottom View

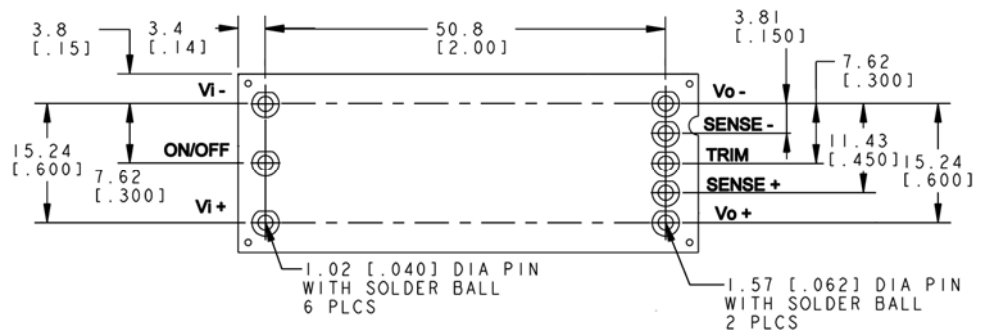

Pin	Function
1	Vi(+)
2	ON/OFF
3	Vi(-)
4	Vo(-)
5	SENSE(-)
6	TRIM
7	SENSE(+)
8	Vo(+)

Mechanical Outline for Through-Hole Module with 1/8th Heat Plate (-H Option)

Dimensions are in millimeters and [inches].
Tolerances: x.x mm ± 0.5 mm [x.xx in. ± 0.02 in.] (Unless otherwise indicated)
x.xx mm ± 0.25 mm [x.xxx in. ± 0.010 in.]

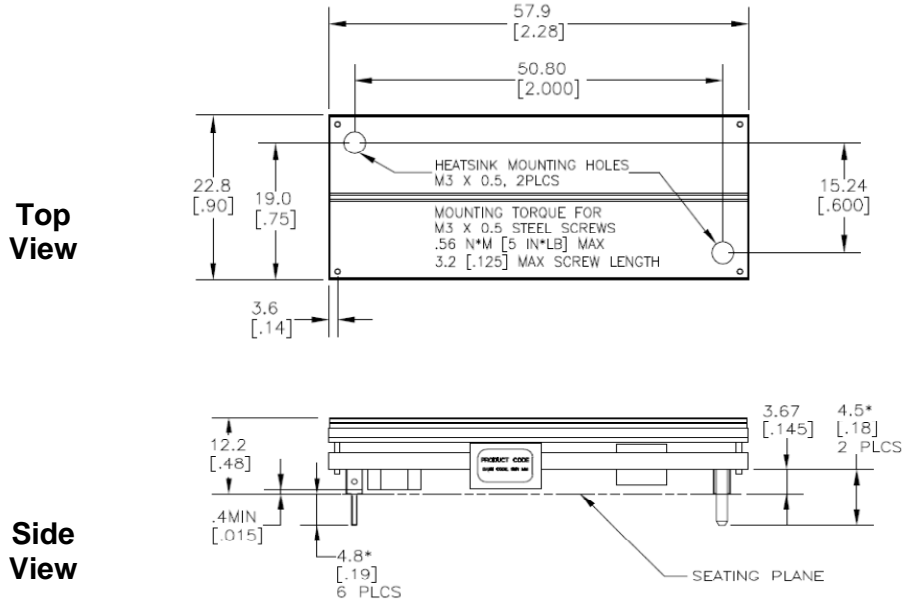

*For optional pin lengths, see Table 2, Device Coding Scheme and Options

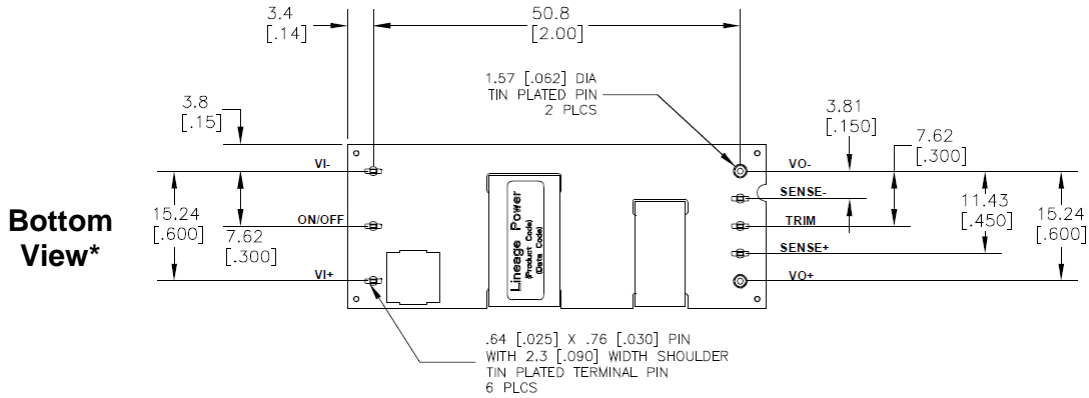

Pin	Function
1	Vi(+)
2	ON/OFF
3	Vi(-)
4	Vo(-)
5	SENSE(-)
6	TRIM
7	SENSE(+)
8	Vo(+)

Mechanical Outline for Through-Hole Module with 1/4th Heat Plate (-18H Option)

Dimensions are in millimeters and [inches].
 Tolerances: x.x mm ± 0.5 mm [x.xx in. ± 0.02 in.] (Unless otherwise indicated)
 x.xx mm ± 0.25 mm [x.xxx in. ± 0.010 in.]

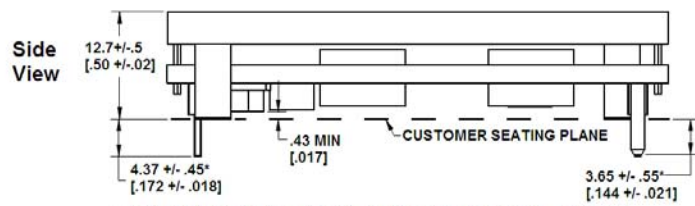
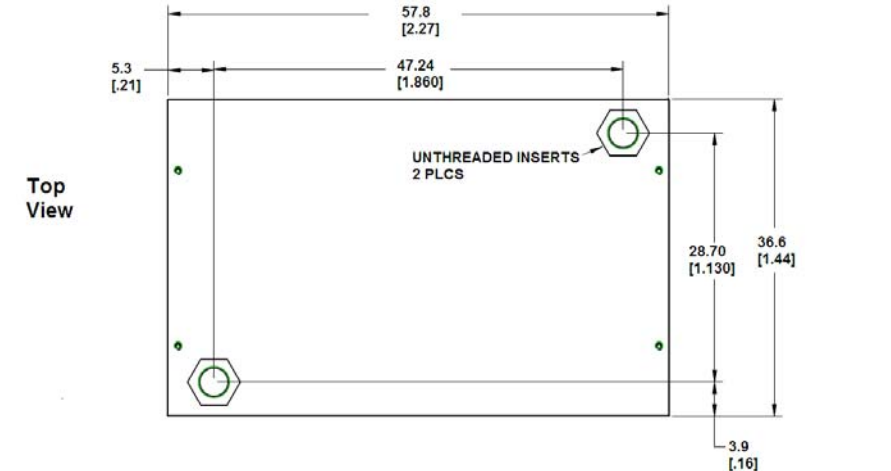

* For option pin lengths, see Table 2, Device Coding Scheme and Options

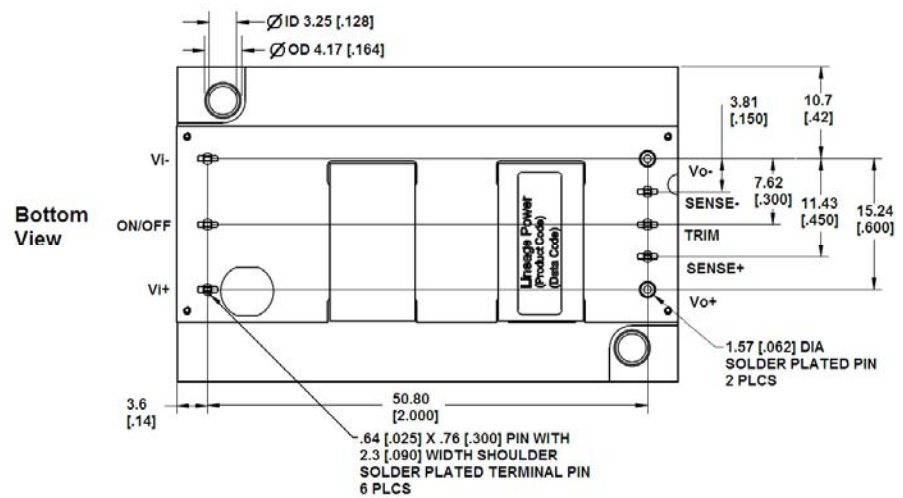

* Bottom side label includes Lineage Power name, product designation and date code.

Pin	Function
1	Vi(+)
2	ON/OFF
3	Vi(-)
4	Vo(-)
5	SENSE(-)
6	TRIM
7	SENSE(+)
8	Vo(+)

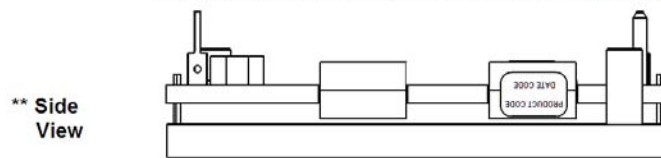

**Side label contains product designation and date code.

Recommended Pad Layout

Dimensions are in millimeters and [inches].

Tolerances: x.x mm ± 0.5 mm [x.xx in. ± 0.02 in.] (Unless otherwise indicated)

x.xx mm ± 0.25 mm [x.xxx in. ± 0.010 in.]

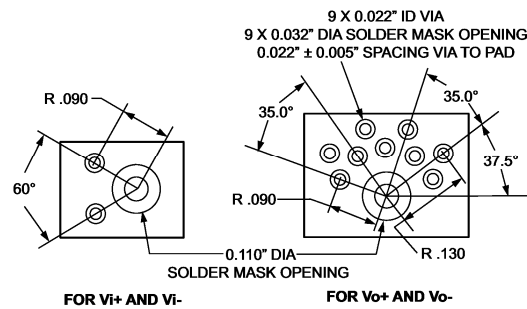
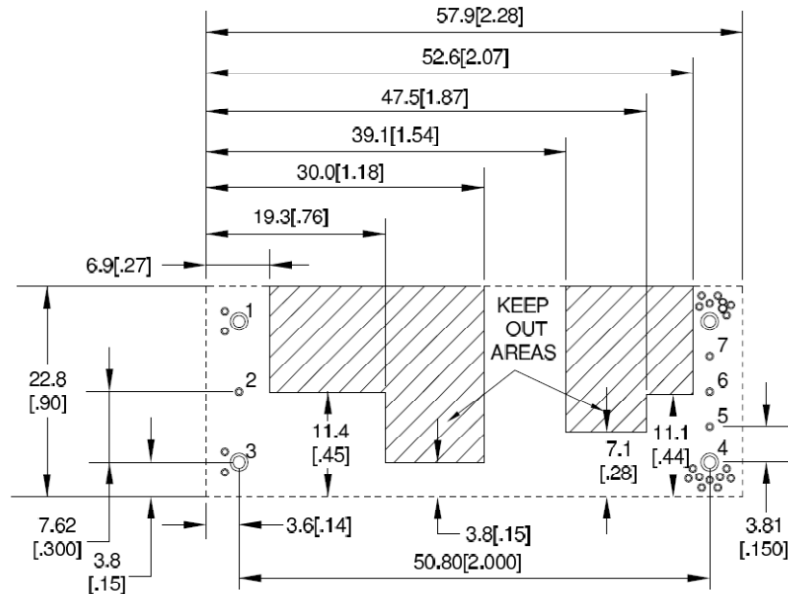

SMT Recommended Pad Layout (Component Side View)

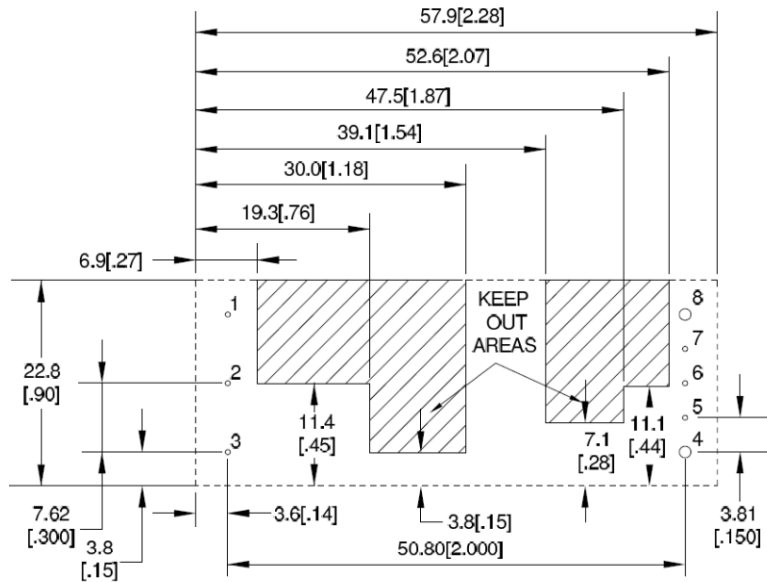

TH Recommended Pad Layout (Component Side View)

Packaging Details

The surface mount versions of the ESTW025A0F modules (suffix –S) are supplied as standard in the plastic tray shown in Figure 24. The tray has external dimensions of 135.1mm(W) x 321.8mm(L) x 12.42mm(H) or 5.319in(W) x 12.669in(L) x 0.489in(H).

Tray Specification

Material	Antistatic coated PVC
Max surface resistivity	$10^{12}\Omega/\text{sq}$
Color	Clear
Capacity	12 power modules
Min order quantity	48 pcs (1 box of 4 full trays)

Each tray contains a total of 12 power modules. The trays are self-stacking and each shipping box will contain 4 full trays plus one empty hold down tray giving a total number of 48 power modules.

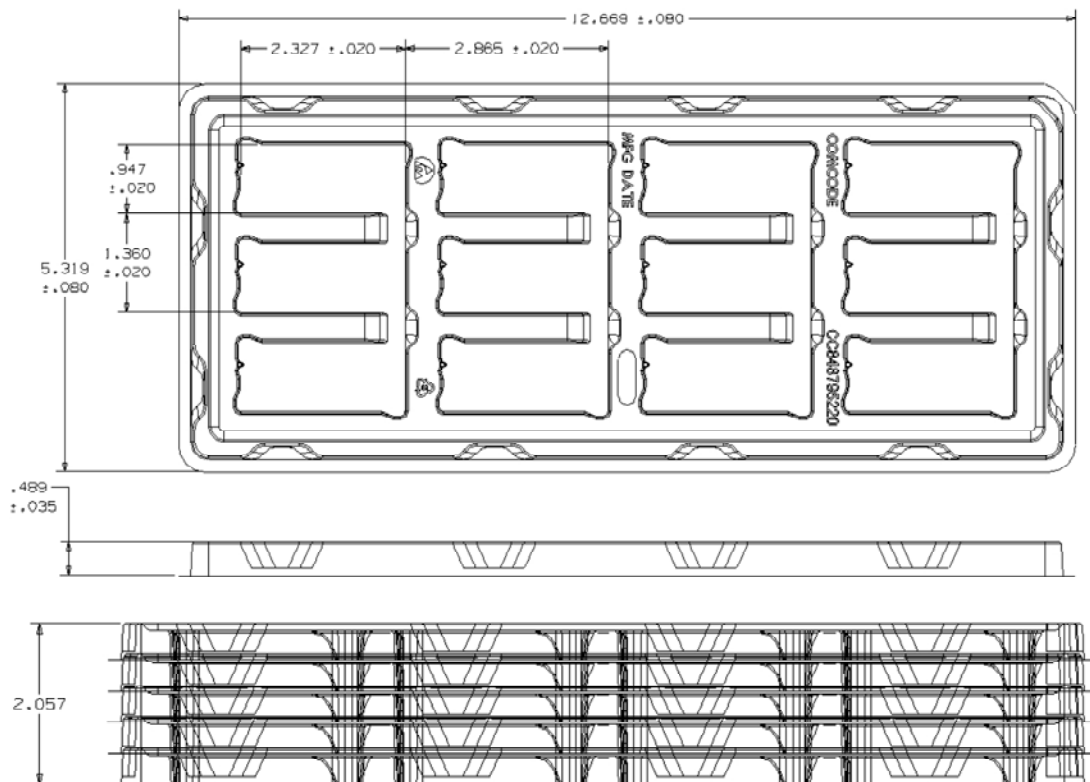

Figure 24. Surface Mount Packaging Tray.

Ordering Information

Please contact your Lineage Power Sales Representative for pricing, availability and optional features.

Table 1. Device Codes

Product Codes	Input Voltage	Output Voltage	Output Current	On/Off Logic	Connector Type	Comcodes
ESTW025A0F41Z	48V (36-75Vdc)	3.3V	25A	Negative	Through hole	CC109158498
ESTW025A0F41-HZ	48V (36-75Vdc)	3.3V	25A	Negative	Through hole	CC109159505
ESTW025A0F41-SZ	48V (36-75Vdc)	3.3V	25A	Negative	Surface Mount	CC109159496
ESTW025A0F641	48V (36-75Vdc)	3.3V	25A	Negative	Through hole	CC109159125
ESTW025A0F4Z	48V (36-75Vdc)	3.3V	25A	Positive	Through hole	CC109168118
ESTW025A0F641Z	48V (36-75Vdc)	3.3V	25A	Negative	Through hole	CC109169363
ESTW025A0F841Z	48V (36-75Vdc)	3.3V	25A	Negative	Through hole	CC109167367
ESTW025A0F64-18HZ	48V (36-75Vdc)	3.3V	25A	Positive	Through hole	CC109172846

Table 2. Device Options

	Characteristic	Character and Position	Definition
Ratings	Form Factor	E	E = Eighth Brick
	Family Designator	ST	ST = Stingray Series
	Input Voltage	W	W = Wide Range, 36V-75V
	Output Current	025A0	025A0 = 025.0 Amps Maximum Output Current
	Output Voltage	F	F = 3.3V nominal
Options	Pin Length	6 8	Omit = Default Pin Length shown in Mechanical Outline Figures 6 = Pin Length: 3.68 mm ± 0.25mm , (0.145 in. ± 0.010 in.) 8 = Pin Length: 2.79 mm ± 0.25mm , (0.110 in. ± 0.010 in.)
	Action following Protective	4	Omit = Latching Mode 4 = Auto-restart following shutdown (Overcurrent/Overvoltage)
	On/Off Logic	1	Omit = Positive Logic 1 = Negative Logic
	Customer Specific	XY	XY = Customer Specific Modified Code, Omit for Standard Code
	Mechanical Feature	H 18H	Omit = Standard open Frame Module H = 1/8th Brick size heat plate, for use with heat sinks (not available with –S option) 18H = 1/4th Brick size heat plate with unthreaded inserts for use in coldwall applications (not available with –S option)
	RoHS		Omit = RoHS 5/6, Lead Based Solder Used Z = RoHS 6/6 Compliant, Lead free



World Wide Headquarters
Lineage Power Corporation
601 Shiloh Road, Plano, TX 75074, USA
+1-800-526-7819
(Outside U.S.A.: +1-972-244-9428)
www.lineagepower.com
e-mail: techsupport1@lineagepower.com

Asia-Pacific Headquarters
Tel: +65 6593 7211

Europe, Middle-East and Africa Headquarters
Tel: +49 89 878067-280

India Headquarters
Tel: +91 80 28411633

Lineage Power reserves the right to make changes to the product(s) or information contained herein without notice. No liability is assumed as a result of their use or application. No rights under any patent accompany the sale of any such product(s) or information.

Lineage Power DC-DC products are protected under various patents. Information on these patents is available at www.lineagepower.com/patents.

© 2011 Lineage Power Corporation, (Plano, Texas) All International Rights Reserved.



Компания «ЭлектроПласт» предлагает заключение долгосрочных отношений при поставках импортных электронных компонентов на взаимовыгодных условиях!

Наши преимущества:

- Оперативные поставки широкого спектра электронных компонентов отечественного и импортного производства напрямую от производителей и с крупнейших мировых складов;
- Поставка более 17-ти миллионов наименований электронных компонентов;
- Поставка сложных, дефицитных, либо снятых с производства позиций;
- Оперативные сроки поставки под заказ (от 5 рабочих дней);
- Экспресс доставка в любую точку России;
- Техническая поддержка проекта, помощь в подборе аналогов, поставка прототипов;
- Система менеджмента качества сертифицирована по Международному стандарту ISO 9001;
- Лицензия ФСБ на осуществление работ с использованием сведений, составляющих государственную тайну;
- Поставка специализированных компонентов (Xilinx, Altera, Analog Devices, Intersil, Interpoint, Microsemi, Aeroflex, Peregrine, Syfer, Eurofarad, Texas Instrument, Miteq, Cobham, E2V, MA-COM, Hittite, Mini-Circuits, General Dynamics и др.);

Помимо этого, одним из направлений компании «ЭлектроПласт» является направление «Источники питания». Мы предлагаем Вам помощь Конструкторского отдела:

- Подбор оптимального решения, техническое обоснование при выборе компонента;
- Подбор аналогов;
- Консультации по применению компонента;
- Поставка образцов и прототипов;
- Техническая поддержка проекта;
- Защита от снятия компонента с производства.



Как с нами связаться

Телефон: 8 (812) 309 58 32 (многоканальный)

Факс: 8 (812) 320-02-42

Электронная почта: org@eplast1.ru

Адрес: 198099, г. Санкт-Петербург, ул. Калинина, дом 2, корпус 4, литера А.