

i6000s Flex AC Current Probe

Instruction Sheet









Introduction

The i6000s 24 Flex and i6000s 36 Flex AC Current Probes (hereafter referred to as “the Probes”) are used with oscilloscopes, digital multimeters, recorders or data loggers. The Probes can be used to measure AC current up to 6000 A. The flexible measuring head allows current measurements on conductors that are hard to reach or inaccessible using typical clamp-on current probes.

The Probes provide a low-voltage (3 V ac) output that is proportional to the current being measured. The Probes provide full-scale direct readings for 60 A, 600 A, and 6000 A.

Symbols

The following table shows the symbols used on the product and/or in this manual.

Symbol	Description
	Do not dispose of this product as unsorted municipal waste. Go to Fluke's website for recycling information.
	Important Information. Refer to the manual.
	Hazardous Voltage. Risk of electric shock.
	Double/Reinforced insulation.
	Do not apply around or remove from the HAZARDOUS LIVE conductors.
	Complies with the relevant European standards.
	Conforms to Underwriters' Laboratory, Inc.
	Conforms to Australian standards.

Safety Instructions

In this instruction sheet, a **Warning** identifies conditions and actions that pose hazard(s) to the user. A **Caution** identifies conditions and actions that may damage the calibrator or the test instruments.

⚠️⚠️ Warning

To avoid electric shock or personal injury:

- **If the Probes are used in a manner not specified in these operating instructions, protection provided by the Probes may be impaired.**
- **Use the Probes only if qualified.**
- **Use caution during installation and use of the Probes; high voltages and currents may be present in circuit under test.**
- **Have maintenance performed by only qualified service personnel.**
- **Protect the Probes against water and humidity.**
- **Wear protective clothing and gloves as required.**
- **Do not install this product on live conductors. Always de-energize the circuit under test before installing the flexible measuring head.**
- **Always inspect the electronics unit, connecting cable, and flexible measuring head for damage before using the Probe.**
- **Do not use the Probe if damaged.**
- **Always connect Probe to display device before installing the flexible measuring head.**
- **Never change batteries while measurement head is installed on conductor.**
- **Never connect or disconnect the external power supply while the measurement head is installed on a conductor.**
- **Use only the provided original or specified accessories.**
- **Adhere to local and national safety codes. Individual protective equipment must be used to prevent shock and arc blast injury where hazardous live conductors are exposed.**
- **CAT III equipment is designed to protect against the transients in the equipment in fixed equipment installations, such as distribution panels, feeders and short branch circuits, and the lighting systems in large buildings.**

Specifications

Electrical Characteristics

Current Ranges	60 A / 600 A / 6000 A ac rms
Output Sensitivity (AC Coupled)	50 mV / 5 mV / 0.5 mV per A
Load Impedance	100 k Ω minimum
Accuracy (at 25 °C)	$\pm 1\%$ of range (45 – 65 Hz)
Linearity (10 % to 100 % of range)	$\pm 0.2\%$ of reading
Noise	8 mV ac rms (60 A) 2 mV ac rms (600/6000 A)
Frequency Range	10 Hz to 50 kHz (- 3 dB)
Phase error	$< \pm 1^\circ$ (45 – 65 Hz), $\pm 10^\circ$ (at 20 kHz)
Position sensitivity (with cable > 25 mm from the coupling)	$\pm 2\%$ of range
External field (with cable >200 mm from the head)	$\pm 1\%$ of range
Power Supply	2 x AA MN 1500 LR6 Alkaline 400 hours, low battery indicator or dedicated ext power supply
Temperature Coefficient	$\pm 0.08\%$ of reading per °C
Working Voltage	600 V ac rms or dc

General Characteristics

Head Cable Length (double insulated)	610 mm (24 in.) i6000s Flex-24 915mm (36 in.) i6000s Flex-36
Cable Diameter	14.3 mm (0.562 in)
Bend Radius	38.1 mm (1.5 in)
Cable Length	2 m long (78.7 in) (head to electronics)
Output Connection	0.5 m cable terminated with safety BNC connector Supplied with 4 mm safety plug adapter
Operating Temperature	- 20 °C to +90 °C (-4 to 194 °F) (head) - 20 °C to +85 °C (-4 to 185 °F) (electronics)
Storage Temperature	- 40 °C to +105 °C (-40 to 221 °F) (head) - 20 °C to +85 °C (-4 to 185 °F) (electronics)
Operating Humidity	15 % to 85 % (non-condensing)
Weight	180 g (head), 190 g (electronics)

Safety Standards

EN 61010-1: 2001

EN 61010-2-032: 2002

EN 61010-031: 2002

600 V rms Category III, Pollution Degree 2.

Use of the Probes on **uninsulated conductors** is limited to 600 V ac rms or dc and frequencies below 1 kHz.

EMC Standards

EN 61326 : 1998 +A1, A2, & A3

Operating Instructions

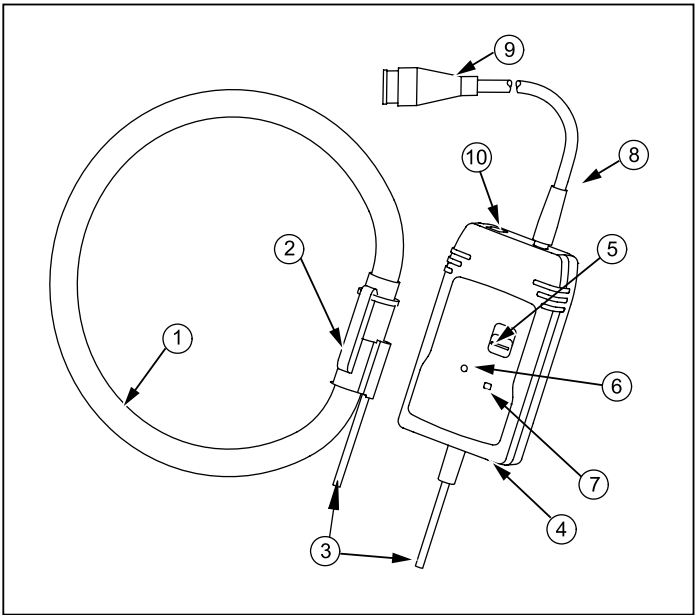

ewf0001.eps

- ① Measuring head
- ② Measuring head coupling
- ③ Head output cable
- ④ Enclosure
- ⑤ Power on/Range selector
- ⑥ Battery low indicator
- ⑦ Power on indicator
- ⑧ Output cable
- ⑨ Safety BNC connector
- ⑩ External power supply input

Battery Installation

⚠️⚠️ Warning

To avoid electric shock or personal injury:

- **Remove Probe from energized circuits before opening battery door.**
- **Never operate the unit without the battery cover installed.**

The Probe requires two AA/MN1500/LR6 alkaline batteries for operation. The battery compartment is accessed from the rear end of the electronic enclosure.

The batteries must be replaced when the LED is lit continuously or when it fails to light up. Ensure that the Probe is away from any current carrying conductor and also that the output is disconnected from other equipment.

To install the battery:

1. Use a coin or a similar tool to turn the battery lock (¼ turn) until the dot aligns with the unlock symbol.
2. Remove the battery cover.
3. Install the batteries ensuring that correct polarity is observed.
4. Replace the battery cover and turn the battery lock until the dot aligns with the lock symbol.

External Power Supply

An optional Class II external power supply is available from Fluke. The power supply is designed to ensure that the Probe continues to meet its specified safety standards. The usage of a power supply from another vendor is not recommended.

⚠️⚠️ Warning

To avoid electric shock or injury, remove Probe and all other connections from energized circuits before connecting external power supply to the instrument.

Measuring Current

⚠️⚠️ Warning

- **To avoid electric shock or injury, read Safety Instructions before operating this product**
- **Ensure that the conductor to be tested is de-energized**

To measure current:

1. Connect the output of the electronics to the input of an oscilloscope or other data recording device.

⚠ ⚠ Warning

To avoid electric shock or injury, the flexible current Probes are not for use on conductors with a potential of over 600 V.

2. Wrap the flexible measuring head around the conductor to be tested in a close coupling manner.
3. Energize the circuit under test.
4. For most accurate measurement, centre the flexible head around the conductor.
5. Locate coupling away from the nearby conductors.

⚠ ⚠ Warning

To avoid electric shock or injury:

- **Do not use the flexible current Probes to measure bare conductors unless wearing protective clothing suitable for high voltage work.**
- **Always use appropriate equipment for personal protection. When installed on bare conductors/busbars, the product must be within a suitable enclosure.**

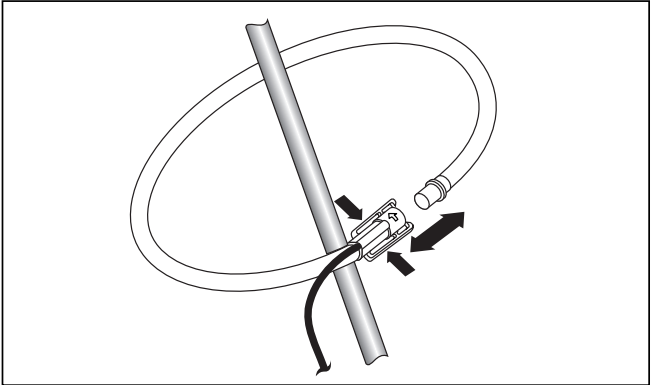

leb0001.eps

Operation

To activate the unit, move the switch from 'Off' position to the required measuring range. If the value of current being measured is unknown, select the 6000 A current range and then reduce accordingly.

Battery Status

Battery status is indicated by an LED on the front of the Probes. This LED will flash one time when the unit is activated. The length of time the LED is lit will increase as battery life decreases. Momentary lighting of LED indicates batteries are good. Continuous lighting of LED indicates low battery and requires replacement at the earliest. No lighting of LED indicates batteries are dead and require replacement immediately.

Maintenance

⚠ ⚠ Warning

To avoid electric shock or injury:

- **Do not use Probes if damaged.**
- **Always inspect the electronics unit, connecting cable, and flexible measuring head for damage before use.**
- **To avoid electric shock, keep the Probes clean and free of surface contamination.**

Use Isopropyl alcohol to clean the control unit and measuring head. Make sure that the flexible measuring head, connecting cable, and electronic enclosure are dry before further use.

LIMITED WARRANTY AND LIMITATION OF LIABILITY

This Fluke product will be free from defects in material and workmanship for one year from the date of purchase. This warranty does not cover fuses, disposable batteries, or damage from accident, neglect, misuse, alteration, contamination, or abnormal conditions of operation or handling. Resellers are not authorized to extend any other warranty on Fluke's behalf. To obtain service during the warranty period, contact your nearest Fluke authorized service center to obtain return authorization information, then send the product to that Service Center with a description of the problem.

THIS WARRANTY IS YOUR ONLY REMEDY. NO OTHER WARRANTIES, SUCH AS FITNESS FOR A PARTICULAR PURPOSE, ARE EXPRESSED OR IMPLIED. FLUKE IS NOT LIABLE FOR ANY SPECIAL, INDIRECT, INCIDENTAL OR CONSEQUENTIAL DAMAGES OR LOSSES, ARISING FROM ANY CAUSE OR THEORY. Since some states or countries do not allow the exclusion or limitation of an implied warranty or of incidental or consequential damages, this limitation of liability may not apply to you.

Fluke Corporation
P.O. Box 9090
Everett, WA 98206-9090
U.S.A.

Fluke Europe B.V.
P.O. Box 1186
5602 BD Eindhoven
The Netherlands



Компания «ЭлектроПласт» предлагает заключение долгосрочных отношений при поставках импортных электронных компонентов на взаимовыгодных условиях!

Наши преимущества:

- Оперативные поставки широкого спектра электронных компонентов отечественного и импортного производства напрямую от производителей и с крупнейших мировых складов;
- Поставка более 17-ти миллионов наименований электронных компонентов;
- Поставка сложных, дефицитных, либо снятых с производства позиций;
- Оперативные сроки поставки под заказ (от 5 рабочих дней);
- Экспресс доставка в любую точку России;
- Техническая поддержка проекта, помощь в подборе аналогов, поставка прототипов;
- Система менеджмента качества сертифицирована по Международному стандарту ISO 9001;
- Лицензия ФСБ на осуществление работ с использованием сведений, составляющих государственную тайну;
- Поставка специализированных компонентов (Xilinx, Altera, Analog Devices, Intersil, Interpoint, Microsemi, Aeroflex, Peregrine, Syfer, Eurofarad, Texas Instrument, Miteq, Cobham, E2V, MA-COM, Hittite, Mini-Circuits, General Dynamics и др.);

Помимо этого, одним из направлений компании «ЭлектроПласт» является направление «Источники питания». Мы предлагаем Вам помощь Конструкторского отдела:

- Подбор оптимального решения, техническое обоснование при выборе компонента;
- Подбор аналогов;
- Консультации по применению компонента;
- Поставка образцов и прототипов;
- Техническая поддержка проекта;
- Защита от снятия компонента с производства.



Как с нами связаться

Телефон: 8 (812) 309 58 32 (многоканальный)

Факс: 8 (812) 320-02-42

Электронная почта: org@eplast1.ru

Адрес: 198099, г. Санкт-Петербург, ул. Калинина, дом 2, корпус 4, литера А.