

RPI-579N1E

Photointerrupter, General type



Absolute maximum ratings (Ta=25°C)

Parameter	Symbol	Limits	Unit	
Input (LED)	Forward current	I_F	35	mA
	Reverse voltage	V_R	5	V
	Power dissipation	P_D	70	mW
Output (photo-transistor)	Collector-emitter voltage	V_{CE0}	30	V
	Emitter-collector voltage	V_{ECO}	4.5	V
	Collector current	I_C	30	mA
	Collector power dissipation	P_C	80	mW
Operating temperature	T_{opr}	-25 to +85	°C	
Storage temperature	T_{stg}	-40 to +85	°C	
Soldering temperature	T_{sol}	260 / 3 *	°C / s	

* 1mm from the body bottom.

Electrical and optical characteristics (Ta=25°C)

Parameter	Symbol	Min.	Typ.	Max.	Unit	Conditions	
Input characteristics	Forward voltage	V_F	-	1.4	1.7	V	$I_F=10\text{mA}$
	Reverse current	I_R	-	-	10	μA	$V_R=5\text{V}$
Output characteristics	Dark current	I_{CE0}	-	-	0.5	μA	$V_{CE}=10\text{V}$
	Peak sensitivity wavelength	λ_P	-	800	-	nm	-
Transfer characteristics	Collector current	I_C	0.5	-	-	mA	$V_{CE}=5\text{V}, I_F=10\text{mA}$
	Collector-emitter saturation voltage	$V_{CE(sat)}$	-	0.1	0.5	V	$I_F=10\text{mA}, I_C=0.1\text{mA}$
Response time	Rise time	t_r	-	10	-	μs	$V_{CC}=5\text{V}, I_F=10\text{mA}, R_L=100\Omega$
	Fall time	t_f	-	10	-	μs	
Infrared light emitter diode	Peak light emitting wavelength	λ_P	-	850	-	nm	$I_F=10\text{mA}$ * Non-coherent Infrared light emitting diode used.
	Response time	$t_r \cdot t_f$	-	10	-	μs	$V_{CC}=5\text{V}, I_C=1\text{mA}, R_L=100\Omega$ * This product is not designed to be protected against electromagnetic wave.
Photo transistor	Maximum sensitivity wavelength	λ_P	-	800	-	nm	-

Applications

Printers
Facsimiles
AV equipment

Features

- 1) Heat resistance (170°C).
- 2) Small gap (0.5mm) and good accuracy.
- 3) Quick response time.
- 4) Filter against visible ray is built-in.
- 5) Kinked forming.

Dimensions (Unit : mm)

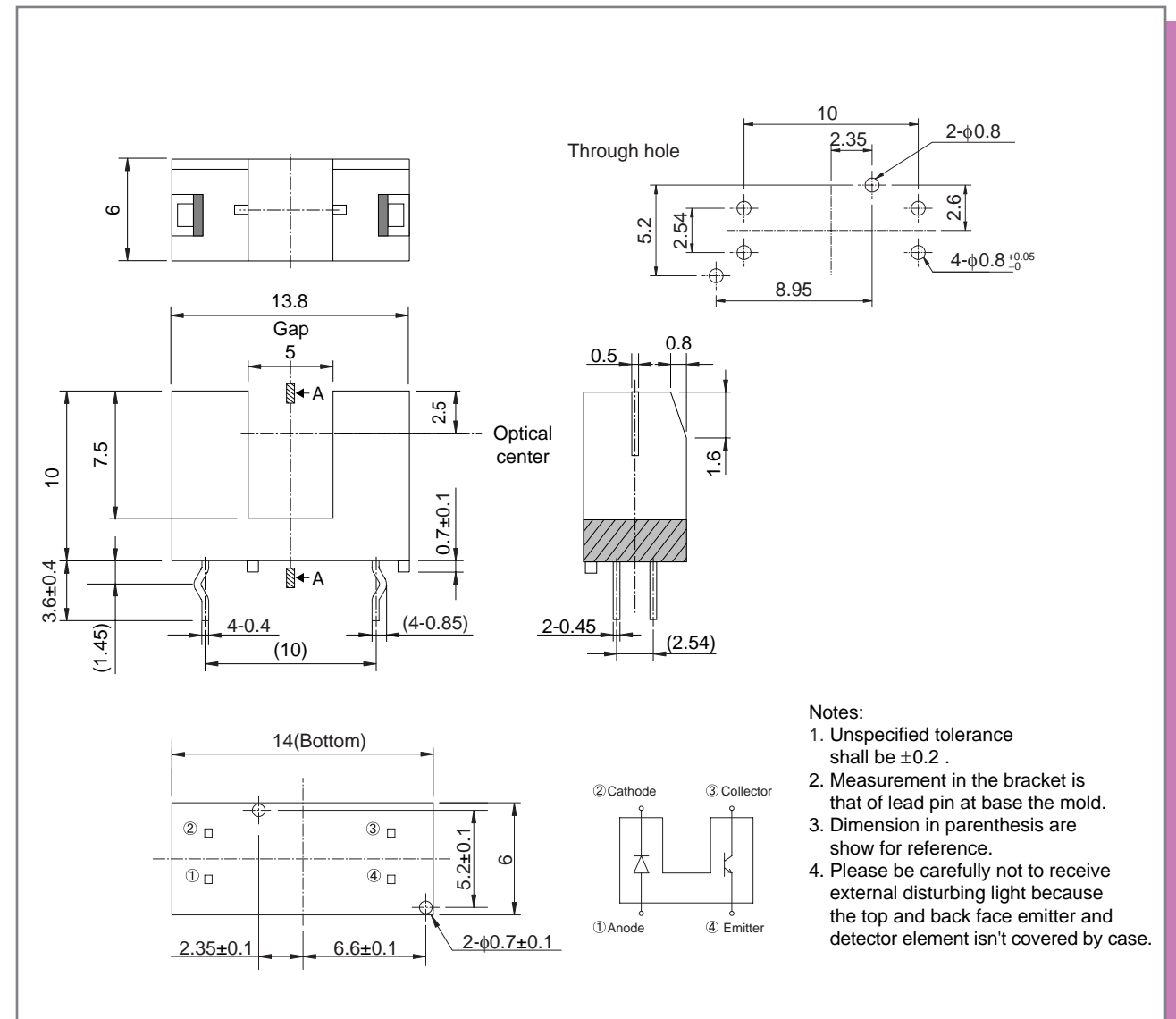

Notes:

1. Unspecified tolerance shall be ± 0.2 .
2. Measurement in the bracket is that of lead pin at base the mold.
3. Dimension in parenthesis are show for reference.
4. Please be carefully not to receive external disturbing light because the top and back face emitter and detector element isn't covered by case.

Electrical and optical characteristics curves

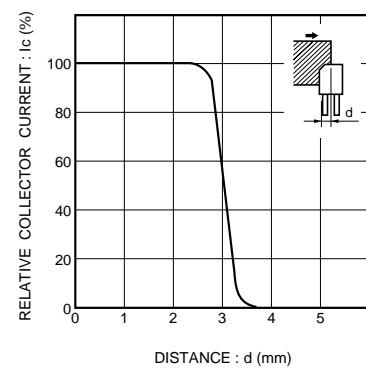

Fig.1 Relative output vs. distance (I)

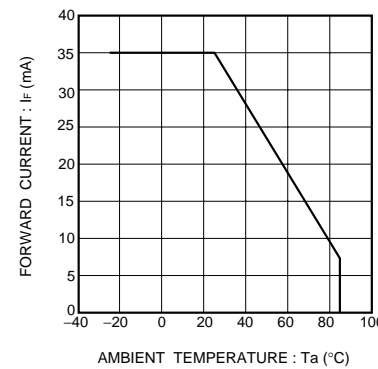

Fig.2 Forward current falloff

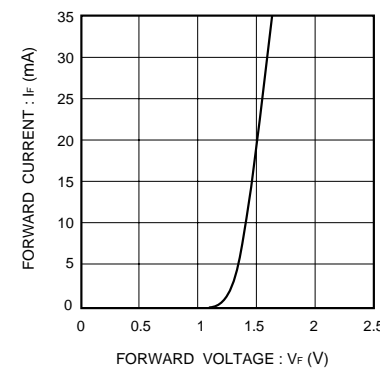

Fig.3 Forward current vs. forward voltage

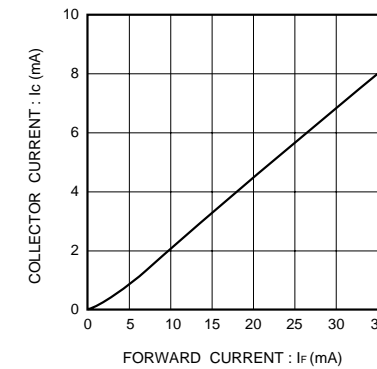

Fig.7 Collector current vs. forward current

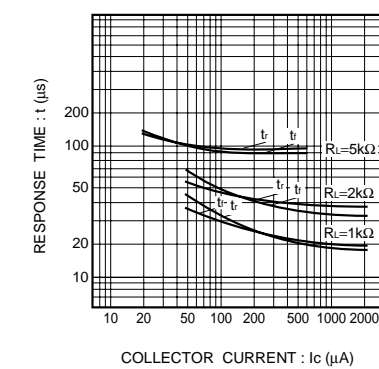

Fig.8 Response time vs. collector current

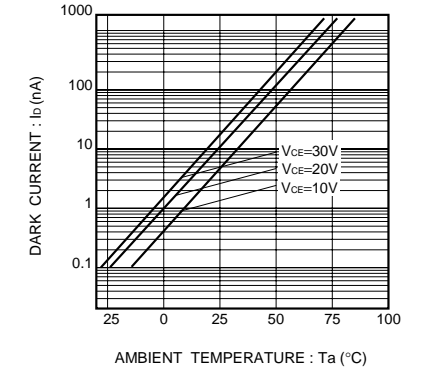

Fig.9 Dark current vs. ambient temperature

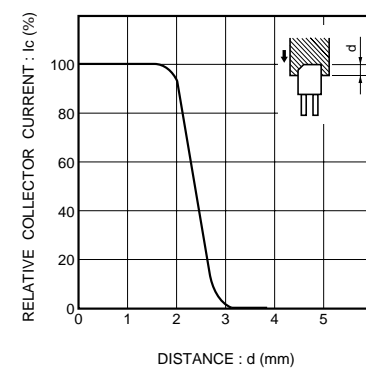

Fig.4 Relative output vs. distance (II)

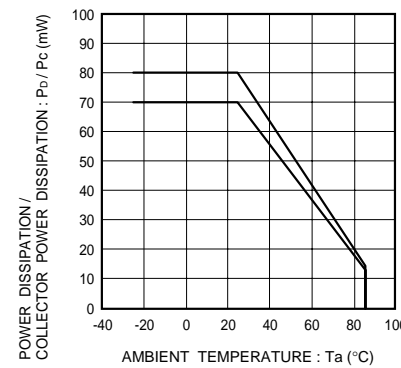

Fig.5 Power dissipation / collector power dissipation vs. ambient temperature

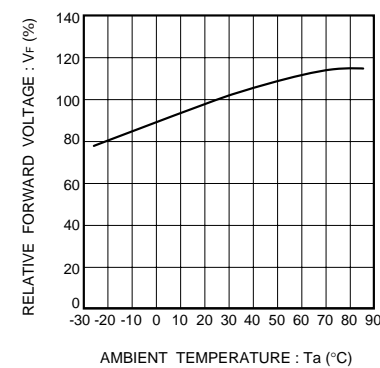

Fig.6 Relative output vs. ambient temperature

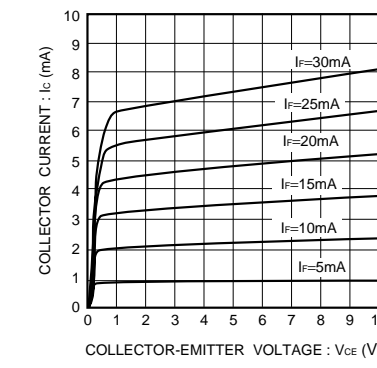

Fig.10 Output characteristics

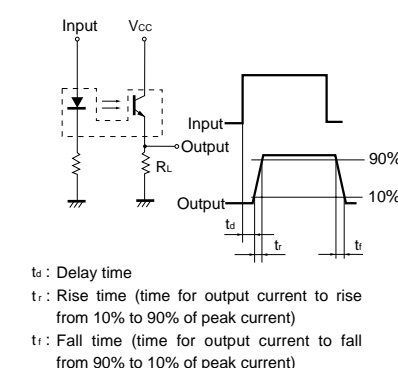

Fig.11 Response time measurement circuit

Notes

- No technical content pages of this document may be reproduced in any form or transmitted by any means without prior permission of ROHM CO.,LTD.
- The contents described herein are subject to change without notice. The specifications for the product described in this document are for reference only. Upon actual use, therefore, please request that specifications to be separately delivered.
- Application circuit diagrams and circuit constants contained herein are shown as examples of standard use and operation. Please pay careful attention to the peripheral conditions when designing circuits and deciding upon circuit constants in the set.
- Any data, including, but not limited to application circuit diagrams information, described herein are intended only as illustrations of such devices and not as the specifications for such devices. ROHM CO.,LTD. disclaims any warranty that any use of such devices shall be free from infringement of any third party's intellectual property rights or other proprietary rights, and further, assumes no liability of whatsoever nature in the event of any such infringement, or arising from or connected with or related to the use of such devices.
- Upon the sale of any such devices, other than for buyer's right to use such devices itself, resell or otherwise dispose of the same, no express or implied right or license to practice or commercially exploit any intellectual property rights or other proprietary rights owned or controlled by
- ROHM CO., LTD. is granted to any such buyer.
- Products listed in this document are no antiradiation design.

The products listed in this document are designed to be used with ordinary electronic equipment or devices (such as audio visual equipment, office-automation equipment, communications devices, electrical appliances and electronic toys).

Should you intend to use these products with equipment or devices which require an extremely high level of reliability and the malfunction of which would directly endanger human life (such as medical instruments, transportation equipment, aerospace machinery, nuclear-reactor controllers, fuel controllers and other safety devices), please be sure to consult with our sales representative in advance.

It is our top priority to supply products with the utmost quality and reliability. However, there is always a chance of failure due to unexpected factors. Therefore, please take into account the derating characteristics and allow for sufficient safety features, such as extra margin, anti-flammability, and fail-safe measures when designing in order to prevent possible accidents that may result in bodily harm or fire caused by component failure. ROHM cannot be held responsible for any damages arising from the use of the products under conditions out of the range of the specifications or due to non-compliance with the NOTES specified in this catalog.

Thank you for your accessing to ROHM product informations.

More detail product informations and catalogs are available, please contact your nearest sales office.

ROHM Customer Support System

THE AMERICAS / EUROPE / ASIA / JAPAN

www.rohm.com

Contact us : webmaster@rohm.co.jp



Компания «ЭлектроПласт» предлагает заключение долгосрочных отношений при поставках импортных электронных компонентов на взаимовыгодных условиях!

Наши преимущества:

- Оперативные поставки широкого спектра электронных компонентов отечественного и импортного производства напрямую от производителей и с крупнейших мировых складов;
- Поставка более 17-ти миллионов наименований электронных компонентов;
- Поставка сложных, дефицитных, либо снятых с производства позиций;
- Оперативные сроки поставки под заказ (от 5 рабочих дней);
- Экспресс доставка в любую точку России;
- Техническая поддержка проекта, помощь в подборе аналогов, поставка прототипов;
- Система менеджмента качества сертифицирована по Международному стандарту ISO 9001;
- Лицензия ФСБ на осуществление работ с использованием сведений, составляющих государственную тайну;
- Поставка специализированных компонентов (Xilinx, Altera, Analog Devices, Intersil, Interpoint, Microsemi, Aeroflex, Peregrine, Syfer, Eurofarad, Texas Instrument, Miteq, Cobham, E2V, MA-COM, Hittite, Mini-Circuits, General Dynamics и др.);

Помимо этого, одним из направлений компании «ЭлектроПласт» является направление «Источники питания». Мы предлагаем Вам помощь Конструкторского отдела:

- Подбор оптимального решения, техническое обоснование при выборе компонента;
- Подбор аналогов;
- Консультации по применению компонента;
- Поставка образцов и прототипов;
- Техническая поддержка проекта;
- Защита от снятия компонента с производства.



Как с нами связаться

Телефон: 8 (812) 309 58 32 (многоканальный)

Факс: 8 (812) 320-02-42

Электронная почта: org@eplast1.ru

Адрес: 198099, г. Санкт-Петербург, ул. Калинина, дом 2, корпус 4, литера А.