

## MoCA Triplex Filter

5 - 85 / 105 - 1002 / 1125 - 1675 MHz

Rev. V3

### Description

- MACOM Technology Solution's MAFL-011026 is a surface mount triplex filter designed for MoCA applications

### Features

- 75 Ohm
- SMT unit
- RoHS compliant

### Block Diagram

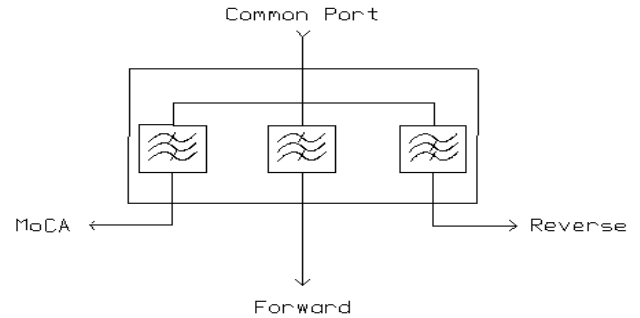

Electrical specifications:  $T_A = 25^\circ\text{C}$ ,  $Z_0 75\Omega$

Parameter	Units	Min	Typ	Max
<b>Reverse Path Insertion loss</b>				
5-85 MHz	dB	-	1.2	1.5
<b>Rejection</b>				
105-126 MHz	dB	62	70	-
126-860 MHz	dB	64	70	-
860-1002 MHz	dB	64	70	-
1125-1675 MHz	dB	60	64	-
1675-3000 MHz	dB	30	50	-
<b>Forward path Insertion loss</b>				
105-126 MHz	dB	-	1.5	2.0
126-860 MHz	dB	-	0.75	1.5
860-1002 MHz	dB	-	2.5	2.75
<b>Rejection</b>				
5-38 MHz	dB	50	55	-
38-85 MHz	dB	43	45	-
1125 - 1675 MHz	dB	43	45	-
1675-3000 MHz	dB	20	30	-
<b>MoCA Path Insertion Loss</b>				
1125-1150 MHz	dB	-	2.8	3.0
1150-1650 MHz	dB	-	2.5	2.7
1650-1675 MHz	dB	-	2.5	3.0
<b>Rejection</b>				
5-85 MHz	dB	49	70	-
85-1002 MHz	dB	49	55	-
2300-3000 MHz	dB	25	35	-

Parameter	Units	Min	Typ	Max
<b>Input Return Loss</b>				
5-85 MHz	dB	16	18	-
105-860MHz	dB	16	18	-
860-1002MHz	dB	12	16	-
1125-1675 MHz	dB	12	16	-
<b>Isolation</b>				
<b>Forward to Reverse</b>				
5-38 MHz	dB	55	58	-
38-85 MHz	dB	43	45	-
105-126 MHz	dB	60	65	-
126-860 MHz	dB	60	65	-
860-1002 MHz	dB	60	65	-
<b>Forward to MoCA</b>				
5-85 MHz	dB	49	70	-
105-126 MHz	dB	49	70	-
126-860 MHz	dB	49	53	-
860-1002 MHz	dB	49	55	-
1125-1150 MHz	dB	43	45	-
1150-1650 MHz	dB	43	50	-
1650-1675 MHz	dB	43	50	-

### Pin Configuration

Function	Pin Number
MoCA Port	1
Forward Port	4
Reverse Port	7
Common Port	14
Ground	2, 3, 5, 6, 8-13, 15-20

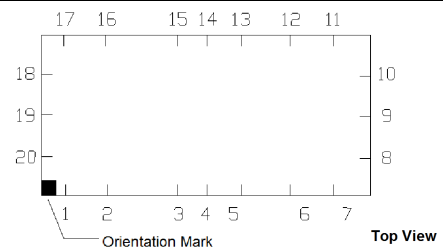

### Recommended Maximum Ratings

Parameter	Absolute maximum
RF power	250mW
DC current	30mA
Operating temperature	-40°C to +85°C
Storage temperature	-40°C to +85°C

\* Restrictions on Hazardous Substances, European Union Directive 2002/95/EC.

M/A-COM Technology Solutions Inc. (MACOM) and its affiliates reserve the right to make changes to the product(s) or information contained herein without notice. Visit [www.macomtech.com](http://www.macomtech.com) for additional data sheets and product information.

- North America** Tel: 800.366.2266 / Fax: 978.366.2266
- Europe** Tel: 44.1908.574.200 / Fax: 44.1908.574.300
- Asia/Pacific** Tel: 81.44.844.8296 / Fax: 81.44.844.8298

## Filter Dimensions

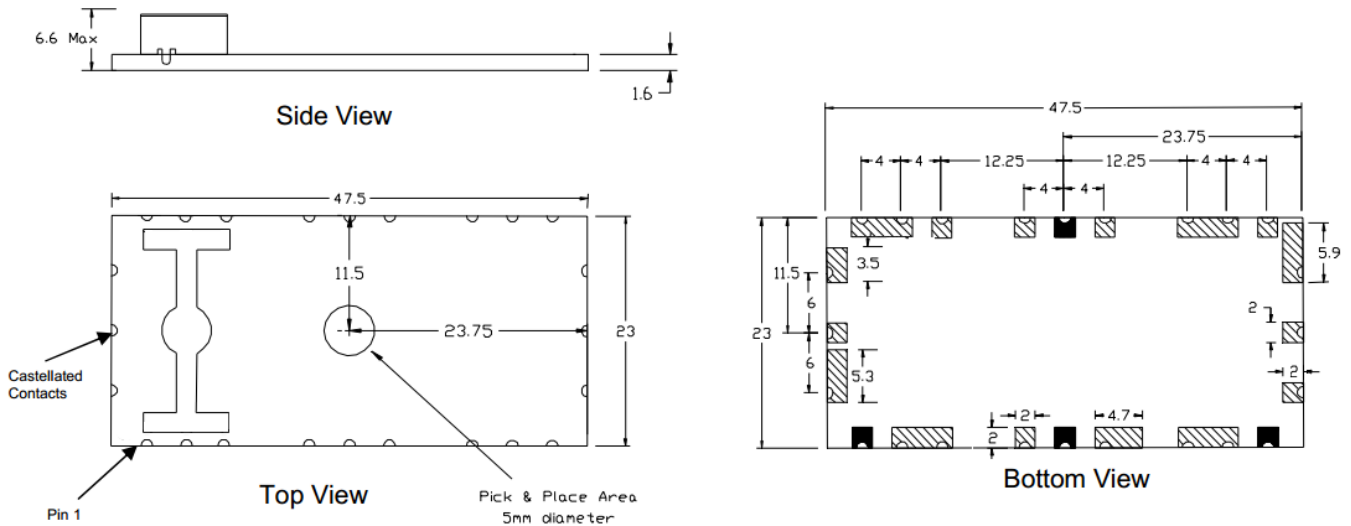

Dimensions in mm. Tolerance:  $.x \pm 0.1$  unless otherwise noted

Solder Resist Colour: Black

PCB Pad Finish: ENIG

## Application Schematic

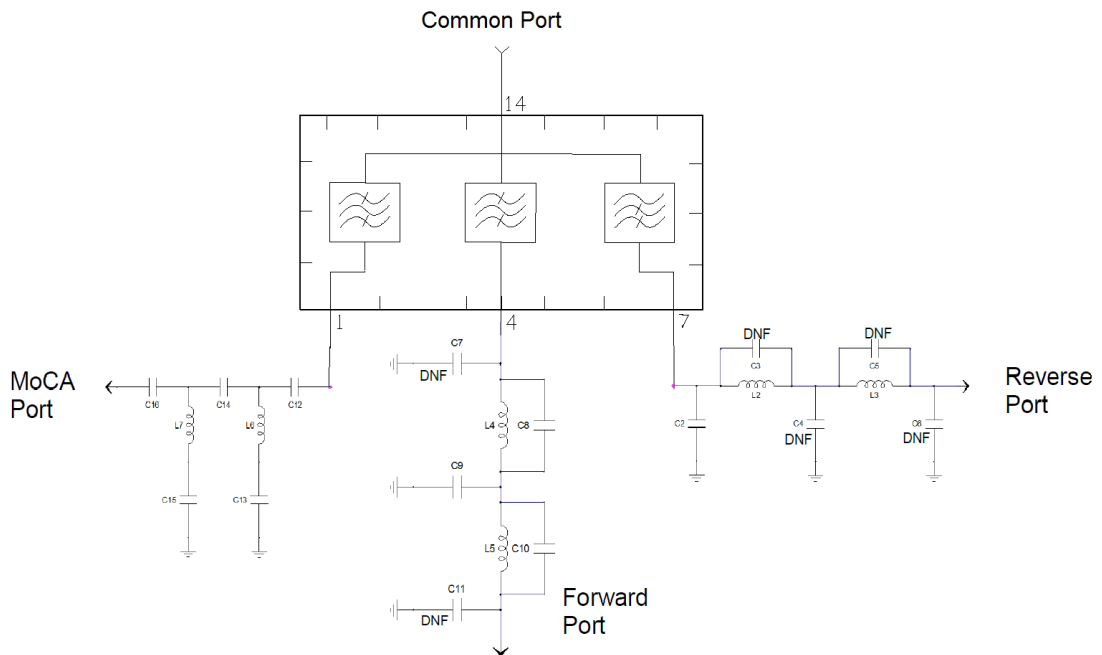

DNF: Do Not Fit

M/A-COM Technology Solutions Inc. (MACOM) and its affiliates reserve the right to make changes to the product(s) or information contained herein without notice. Visit [www.macomtech.com](http://www.macomtech.com) for additional data sheets and product information.

- **North America** Tel: 800.366.2266 / Fax: 978.366.2266
- **Europe** Tel: 44.1908.574.200 / Fax: 44.1908.574.300
- **Asia/Pacific** Tel: 81.44.844.8296 / Fax: 81.44.844.8298



## MoCA Triplex Filter 5 - 85 / 105 - 1002 / 1125 - 1675 MHz

Rev. V3

### Common Port Return Loss

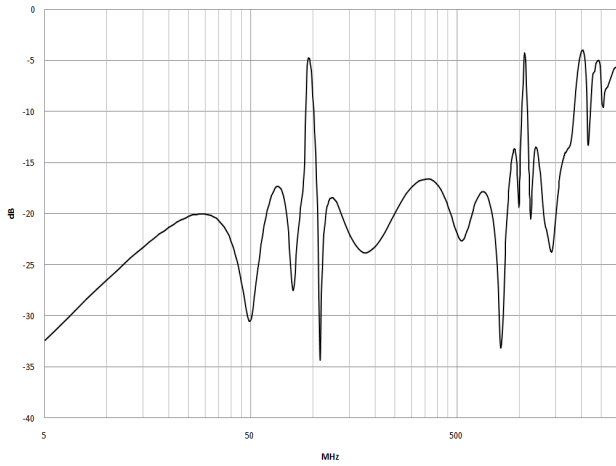

### Reverse Path

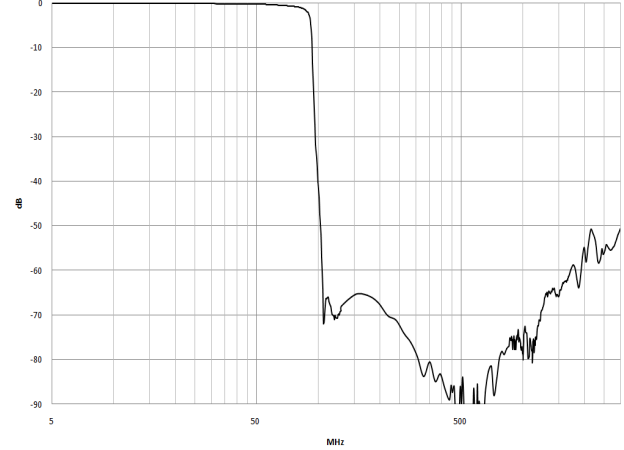

### Forward Path

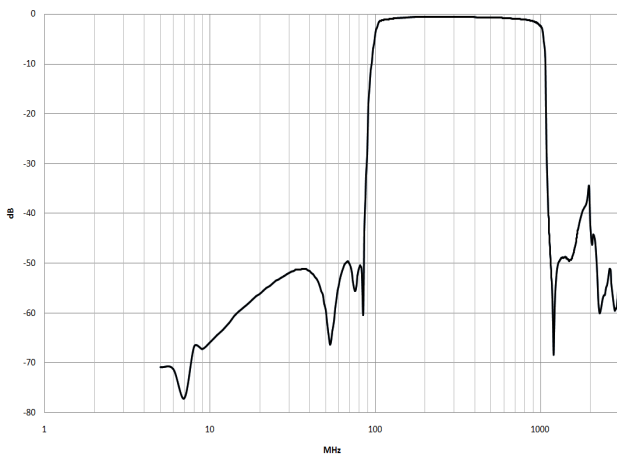

### MoCA Path

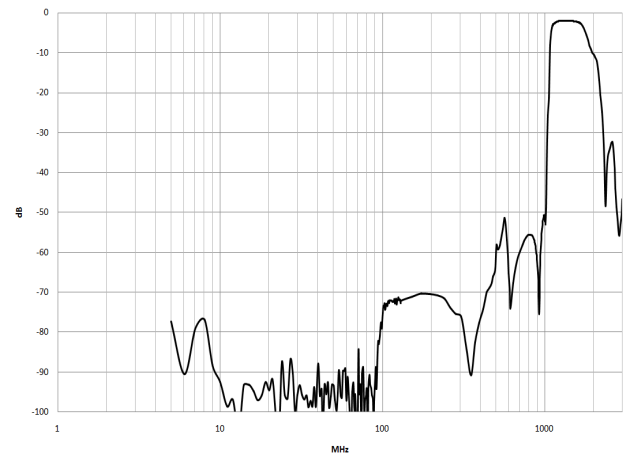

### Reverse to Forward Path Isolation

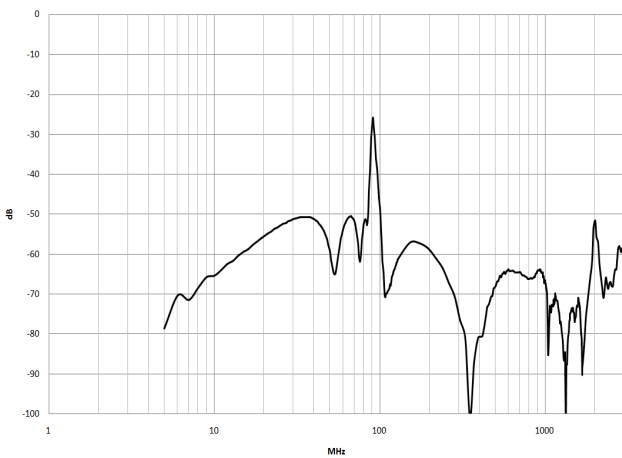

### Forward to MoCA Path Isolation

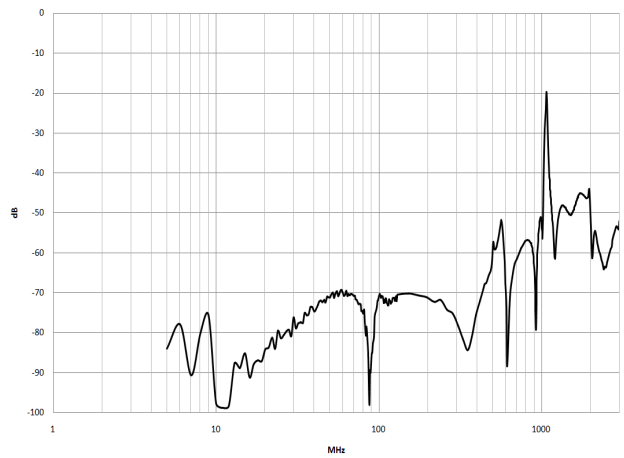

M/A-COM Technology Solutions Inc. (MACOM) and its affiliates reserve the right to make changes to the product(s) or information contained herein without notice. Visit [www.macomtech.com](http://www.macomtech.com) for additional data sheets and product information.

- **North America** Tel: 800.366.2266 / Fax: 978.366.2266
- **Europe** Tel: 44.1908.574.200 / Fax: 44.1908.574.300
- **Asia/Pacific** Tel: 81.44.844.8296 / Fax: 81.44.844.8298

# MAFL-011026



## MoCA Triplex Filter

5 - 85 / 105 - 1002 / 1125 - 1675 MHz

Rev. V3

### Tape & Reel Information

Parameter	Units	Value
Qty per reel	-	200
Reel Size	mm	330
Tape Width	mm	72.0
Pitch	mm	28.0
Ao	mm	23.3
Bo	mm	47.8
Ko	mm	6.8
Orientation	-	F54
Reference Application Note ANI-019 for orientation		

### Ordering Information

Part Number	Package
MAFL-011026	Tape & Reel

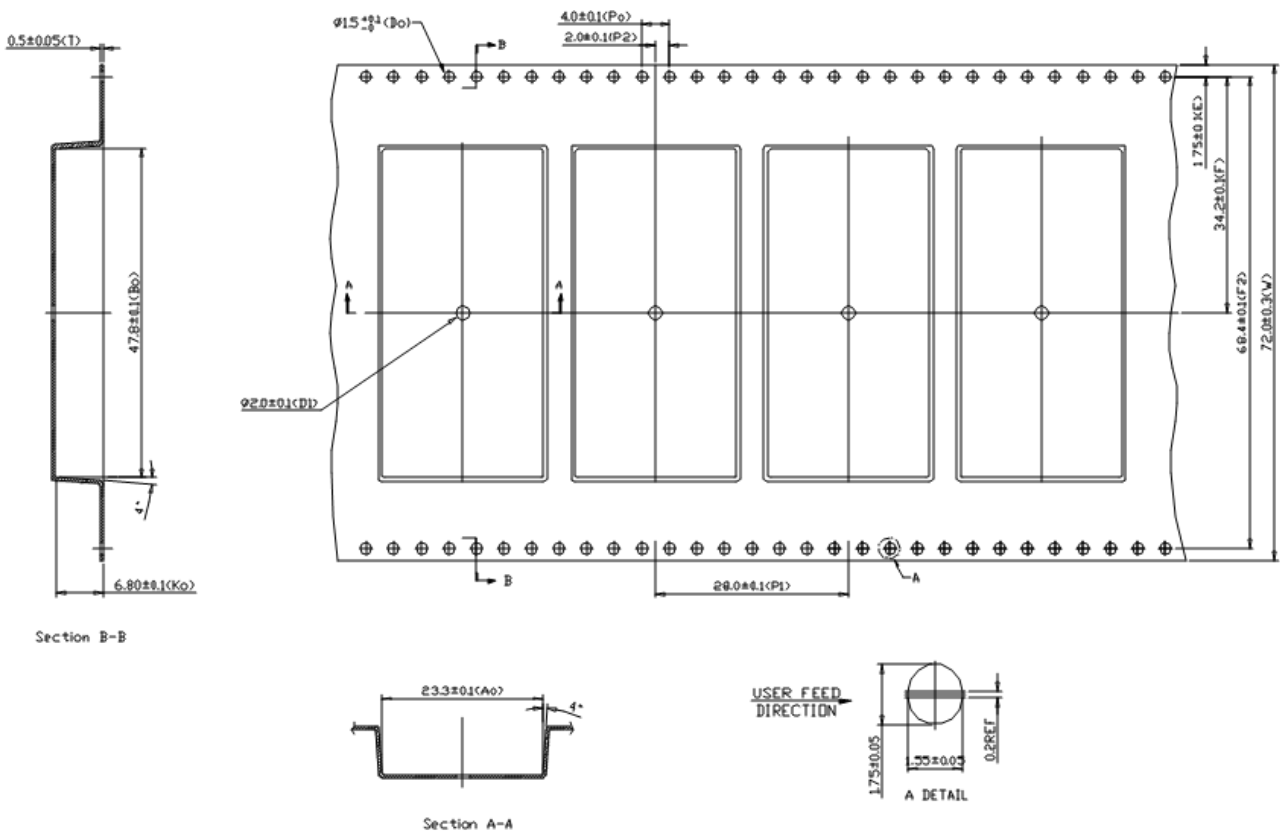

M/A-COM Technology Solutions Inc. (MACOM) and its affiliates reserve the right to make changes to the product(s) or information contained herein without notice. Visit [www.macomtech.com](http://www.macomtech.com) for additional data sheets and product information.

- **North America** Tel: 800.366.2266 / Fax: 978.366.2266
- **Europe** Tel: 44.1908.574.200 / Fax: 44.1908.574.300
- **Asia/Pacific** Tel: 81.44.844.8296 / Fax: 81.44.844.8298

# MAFL-011026



## MoCA Triplex Filter

5 - 85 / 105 - 1002 / 1125 - 1675 MHz

Rev. V3

### Tray Information

Parameter	Units	Value
Min Order Qty	-	480
Tray Length	mm	270
Tray Width	mm	200
Height	mm	20.8
Ao	mm	40
Bo	mm	55
Ko	mm	7.2
Orientation	-	See below

### Ordering Information

Part Number	Package
MAFL-011026-Tray	Tray

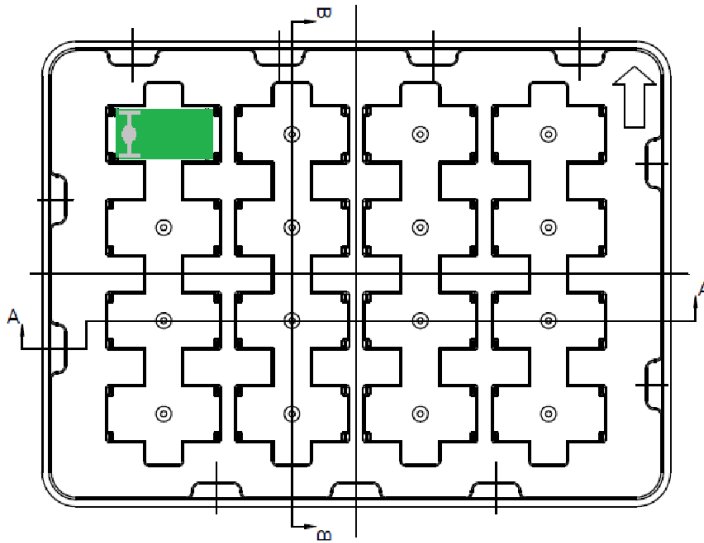

Section B-B

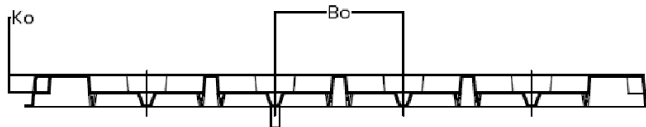

Section A-A

\* Restrictions on Hazardous Substances, European Union Directive 2002/95/EC.

M/A-COM Technology Solutions Inc. (MACOM) and its affiliates reserve the right to make changes to the product(s) or information contained herein without notice. Visit [www.macomtech.com](http://www.macomtech.com) for additional data sheets and product information.

- **North America** Tel: 800.366.2266 / Fax: 978.366.2266
- **Europe** Tel: 44.1908.574.200 / Fax: 44.1908.574.300
- **Asia/Pacific** Tel: 81.44.844.8296 / Fax: 81.44.844.8298



Компания «ЭлектроПласт» предлагает заключение долгосрочных отношений при поставках импортных электронных компонентов на взаимовыгодных условиях!

Наши преимущества:

- Оперативные поставки широкого спектра электронных компонентов отечественного и импортного производства напрямую от производителей и с крупнейших мировых складов;
- Поставка более 17-ти миллионов наименований электронных компонентов;
- Поставка сложных, дефицитных, либо снятых с производства позиций;
- Оперативные сроки поставки под заказ (от 5 рабочих дней);
- Экспресс доставка в любую точку России;
- Техническая поддержка проекта, помощь в подборе аналогов, поставка прототипов;
- Система менеджмента качества сертифицирована по Международному стандарту ISO 9001;
- Лицензия ФСБ на осуществление работ с использованием сведений, составляющих государственную тайну;
- Поставка специализированных компонентов (Xilinx, Altera, Analog Devices, Intersil, Interpoint, Microsemi, Aeroflex, Peregrine, Syfer, Eurofarad, Texas Instrument, Miteq, Cobham, E2V, MA-COM, Hittite, Mini-Circuits, General Dynamics и др.);

Помимо этого, одним из направлений компании «ЭлектроПласт» является направление «Источники питания». Мы предлагаем Вам помощь Конструкторского отдела:

- Подбор оптимального решения, техническое обоснование при выборе компонента;
- Подбор аналогов;
- Консультации по применению компонента;
- Поставка образцов и прототипов;
- Техническая поддержка проекта;
- Защита от снятия компонента с производства.



#### Как с нами связаться

**Телефон:** 8 (812) 309 58 32 (многоканальный)

**Факс:** 8 (812) 320-02-42

**Электронная почта:** [org@eplast1.ru](mailto:org@eplast1.ru)

**Адрес:** 198099, г. Санкт-Петербург, ул. Калинина, дом 2, корпус 4, литера А.