

# E3ZM

## Stainless Steel Housing Ideal for Food Industry **PAT Pending**

- Strong resistance against detergents, disinfectants, and jet liquid flow.
- Product lineup includes BGS Reflective Models and Through-beam Models with built-in slits.
- Certified by Ecolab Europe.



 Be sure to read *Safety Precautions* on page 13.

### Features



#### Withstands Detergent and Disinfectant Spray

We used SUS316L for the case and the best material for all parts to achieve **200 times the durability of the E3Z** (in 1.5% solution of sodium hydroxide at 70°C) to make the E3ZM suitable for the cleaning conditions of food-processing machinery.



#### Superior Protective Structure

The first **IP69K\*** (DIN 40050-9) protective structure in the world for a square metal photoelectric sensor. Suitable for high-temperature, high-pressure jet water spray cleaning applications.

\* Refer to the footnote on page 5 (ratings and specifications table).

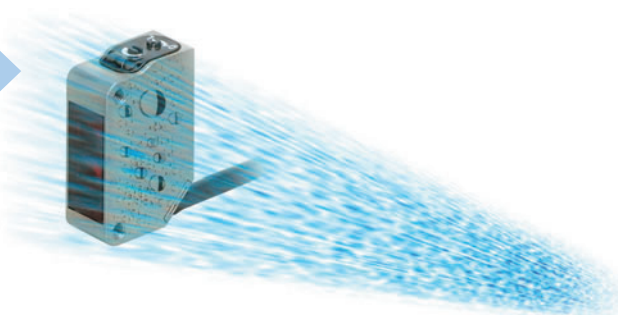

#### Shape and Markings Designed for Greater Hygiene

Few indentations in the shape means less dust and water can collect, making the E3ZM more hygienic. No labels have been used in order to **prevent foreign matter contaminating food** products. The E3ZM model and lot numbers are imprinted using a laser marker.

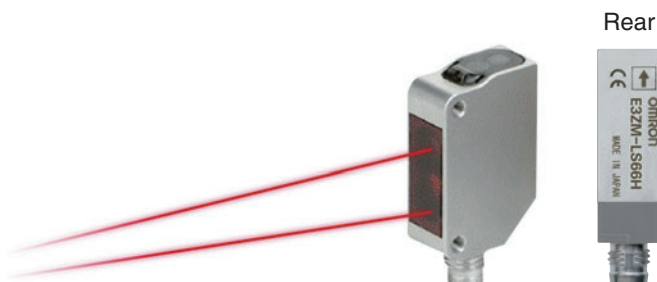

Rear

## Structural Design That Provides Excellent Environment-resistance\*

### Waterproofing ring: Fluorine rubber

Excellent resistance to detergents and disinfectants.

### Optical plate: Polymethylmethacrylate (PMMA)

Excellent resistance to detergents and disinfectants. High transparency and other qualities give PMMA excellent optical characteristics.

### Seal

The seal provides the durability to high-temperature and high-pressure water that complies with IP69K.

### Indicator cover: Polyethersulfone (PES)

Excellent resistance to detergents and disinfectants.

### Sensitivity adjustment and mode selector switch: Polyetheretherketone (PEEK)

Excellent resistance to detergents and disinfectants. Also has excellent abrasion resistance.

### Case: SUS316L

Excellent corrosion resistance to many chemical reagents.

### Cable: Polyvinylchloride

Excellent resistance to detergents and disinfectants.

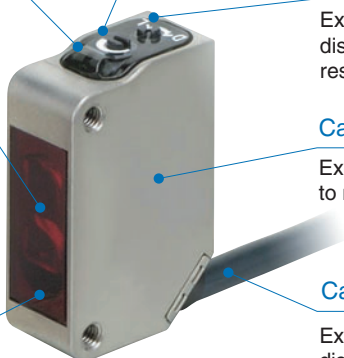

\*Do not use the E3ZM in an oily environment.

## Unique Members of the E3ZM Family

### BGS Reflective Models

#### E3ZM-LS6□H/-LS8□H

Three models with different fixed sensitivity (rated sensing distances) have been created. These models cover the sensing ranges of the E3Z-LS61.

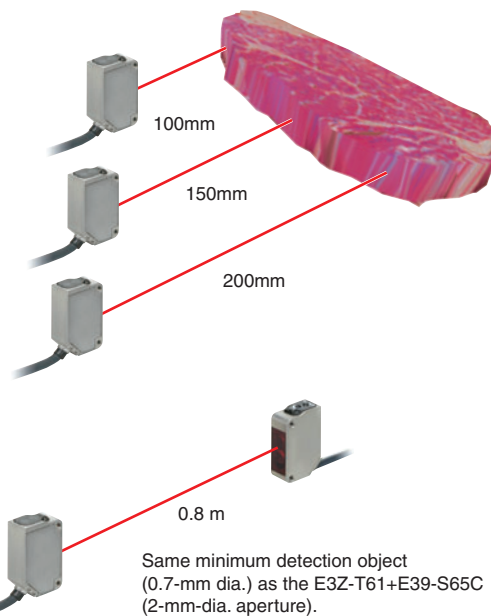

### Through-beam Inner Aperture Models

#### E3ZM-T63

Fine beam without attaching an external aperture. This eliminates malfunctions from residual water drops, even immediately after washing.

## A Better Fit for the Application

The E3ZM can be used in those harsh cleaning environments in which the E3Z was difficult to use. E3ZM passed the material resistance tests and is certified by Ecolab.

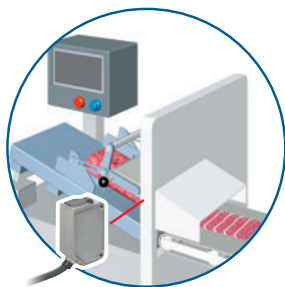







Processing and wrapping of meat or raw food products

<p>Ecobab GmbH &amp; Co. OHG R.D. Box 13 34 06 D-40551 Düsseldorf certifies that for</p> <p>OMRON Manufacturing of Germany GmbH Carl-Benz-Strasse 4 71154 Nutringen</p> <p><b>material resistance tests</b></p> <p>were performed with cleaning substances P3-topax 56, P3-topax 66, P3-topax 91, P3 Topactiv DES and demineralized water as a zero reference factor.</p> <p>The material resistance of the tested series</p> <p>Photoelectric Sensor E3ZM</p> <p>to the P3 products used in the test can be considered to be positive according to the cleaning procedure mentioned overleaf.</p> <p>Düsseldorf, 14th February 2006</p> <p>Ecobab GmbH &amp; Co. OHG</p> <p>L.V.  L.V. </p> <p>Thomas Tyborski Reimund Laaf</p>	<p>This certificate is based on:</p> <ul style="list-style-type: none"> <li>documented test procedures (test no.: FAE/P3 E Nr. 40-1)</li> <li>according to material resistance</li> <li>defined product descriptions.</li> <li>standardized cleaning procedure</li> </ul> <table border="1"> <tr> <td> <p><b>Test procedure</b> Ecobab-test FAE Nr. 40-1</p> <p><b>Dipping test:</b></p> <ul style="list-style-type: none"> <li>Complete immersion in solution/liquid</li> </ul> <p><b>Test period:</b></p> <ul style="list-style-type: none"> <li>10 days</li> </ul> <p><b>Temperature:</b></p> <ul style="list-style-type: none"> <li>room temperature (constant)</li> </ul> <p><b>Analysis:</b></p> <ul style="list-style-type: none"> <li>Visual judgement like swelling, brittleness, discoloring</li> <li>compared to zero-reference factor (demineralized water)</li> <li>Photometric documentation</li> </ul> </td> <td> <p><b>Product specifications:</b></p> <p><b>P3-topax 56:</b> Acid foam cleaning substance for food industry</p> <p><b>P3-topax 66:</b> Alkaline cleaning detergent with active chlorine for effective cleaning in food and beverage industry</p> <p><b>P3-topax 91:</b> Neutral disinfection agent based on quaternary ammonium compounds (QAC) for food industry</p> <p><b>P3-topactiv DES:</b> Acid-disinfectant based on Peroxalic Acid and Hydrogen Peroxide for the food and beverage industry</p> </td> </tr> </table> <p><b>Cleaning plan for food and beverage industry*</b></p> <ul style="list-style-type: none"> <li> <b>Rinsing with water 40 – 50°C</b> Rinsing with low pressure. Rinsing from top to bottom in the direction of the drain. Cleaning of the drains.</li> <li> <b>Brushing from bottom to top:</b> alkaline P3-topax 66 2 – 5 % daily acid: P3-topax 56 2 % on demand temperature: cold up to 40°C contact time: 15 min. recommended</li> <li> <b>Rinsing with water 40 – 50°C</b> Rinsing from top to bottom with low pressure</li> <li> <b>Spray disinfection P3-topactiv DES 1.2 %</b>, 10-30 minutes</li> </ul>	<p><b>Test procedure</b> Ecobab-test FAE Nr. 40-1</p> <p><b>Dipping test:</b></p> <ul style="list-style-type: none"> <li>Complete immersion in solution/liquid</li> </ul> <p><b>Test period:</b></p> <ul style="list-style-type: none"> <li>10 days</li> </ul> <p><b>Temperature:</b></p> <ul style="list-style-type: none"> <li>room temperature (constant)</li> </ul> <p><b>Analysis:</b></p> <ul style="list-style-type: none"> <li>Visual judgement like swelling, brittleness, discoloring</li> <li>compared to zero-reference factor (demineralized water)</li> <li>Photometric documentation</li> </ul>	<p><b>Product specifications:</b></p> <p><b>P3-topax 56:</b> Acid foam cleaning substance for food industry</p> <p><b>P3-topax 66:</b> Alkaline cleaning detergent with active chlorine for effective cleaning in food and beverage industry</p> <p><b>P3-topax 91:</b> Neutral disinfection agent based on quaternary ammonium compounds (QAC) for food industry</p> <p><b>P3-topactiv DES:</b> Acid-disinfectant based on Peroxalic Acid and Hydrogen Peroxide for the food and beverage industry</p>
<p><b>Test procedure</b> Ecobab-test FAE Nr. 40-1</p> <p><b>Dipping test:</b></p> <ul style="list-style-type: none"> <li>Complete immersion in solution/liquid</li> </ul> <p><b>Test period:</b></p> <ul style="list-style-type: none"> <li>10 days</li> </ul> <p><b>Temperature:</b></p> <ul style="list-style-type: none"> <li>room temperature (constant)</li> </ul> <p><b>Analysis:</b></p> <ul style="list-style-type: none"> <li>Visual judgement like swelling, brittleness, discoloring</li> <li>compared to zero-reference factor (demineralized water)</li> <li>Photometric documentation</li> </ul>	<p><b>Product specifications:</b></p> <p><b>P3-topax 56:</b> Acid foam cleaning substance for food industry</p> <p><b>P3-topax 66:</b> Alkaline cleaning detergent with active chlorine for effective cleaning in food and beverage industry</p> <p><b>P3-topax 91:</b> Neutral disinfection agent based on quaternary ammonium compounds (QAC) for food industry</p> <p><b>P3-topactiv DES:</b> Acid-disinfectant based on Peroxalic Acid and Hydrogen Peroxide for the food and beverage industry</p>		

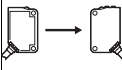
## Ordering Information

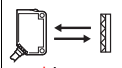
### Sensors (Refer to Dimensions on page 15.)

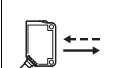
 Red light  Infrared light

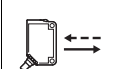
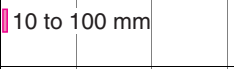
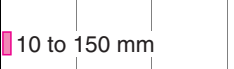
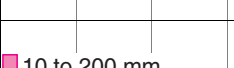
Sensing method	Appearance	Connection method	Sensing distance	Model	
				NPN output	PNP output
Through-beam *4 (Emitter + Receiver) *5		Pre-wired (2 m) *3	 15 m	<b>E3ZM-T61 2M</b>	<b>E3ZM-T81 2M</b>
		Connector (M8, 4 pins)		<b>E3ZM-T66</b>	<b>E3ZM-T86</b>
		Pre-wired (2 m) *3	 0.8 m (apertures built in)	<b>E3ZM-T63 2M</b>	<b>E3ZM-T83 2M</b>
		Connector (M8, 4 pins)		<b>E3ZM-T68</b>	<b>E3ZM-T88</b>
Retro-reflective with MSR function	 *1	Pre-wired (2 m) *3	 4 m (100 mm) *2 (Using E39-R1S)	<b>E3ZM-R61 2M</b>	<b>E3ZM-R81 2M</b>
		Connector (M8, 4 pins)		<b>E3ZM-R66</b>	<b>E3ZM-R86</b>
Diffuse-reflective		Pre-wired (2 m) *3	 1 m	<b>E3ZM-D62 2M</b>	<b>E3ZM-D82 2M</b>
		Connector (M8, 4 pins)		<b>E3ZM-D67</b>	<b>E3ZM-D87</b>
BGS reflective (fixed distance)		Pre-wired (2 m) *3	 10 to 100 mm	<b>E3ZM-LS61H 2M</b>	<b>E3ZM-LS81H 2M</b>
		Connector (M8, 4 pins)		<b>E3ZM-LS66H</b>	<b>E3ZM-LS86H</b>
		Pre-wired (2 m) *3	 10 to 150 mm	<b>E3ZM-LS62H 2M</b>	<b>E3ZM-LS82H 2M</b>
		Connector (M8, 4 pins)		<b>E3ZM-LS67H</b>	<b>E3ZM-LS87H</b>
		Pre-wired (2 m) *3	 10 to 200 mm	<b>E3ZM-LS64H 2M</b>	<b>E3ZM-LS84H 2M</b>
		Connector (M8, 4 pins)		<b>E3ZM-LS69H</b>	<b>E3ZM-LS89H</b>

\*1. The Reflector is sold separately. Select the Reflector model most suited to the application.

\*2. Values in parentheses indicate the minimum required distance between the Sensor and Reflector.

\*3. Pre-wired Models with a 5-m cable are also available for these products. When ordering, specify the cable length by adding "5M" to the end of the model number (e.g., E3ZM-LT61 5M).

\*4. Through-beam Models are also available with a light emission stop function. When ordering, add "-G0" to the end of the model number (e.g., E3ZM-T61-G0).

\*5. The model number of the Emitter is expressed by adding an "L" to the set model number in the table. Example: E3ZM-T61-L 2M

The model number of the receiver is expressed by adding a "D" to the set model number in the table. Example: E3ZM-T61-D 2M

Orders for individual Emitters and Receivers are accepted. (Modifications are required for some models.)

### Accessories (Order Separately)

**Reflectors** (A Reflector is required for Retro-reflective Sensors: A Reflector is not provided with the Sensor. Be sure to order a Reflector.)









(Refer to Dimensions on E39-L/F39-L/E39-S/E39-R.)

Name	E3ZM-R Sensing distance (typical) *	Model	Quantity	Remarks
Reflector	3 m (100 mm) (rated value)	<b>E39-R1</b>	1	<ul style="list-style-type: none"> <li>• Reflectors are not provided with Retro-reflective models.</li> <li>• The MSR function is enabled.</li> </ul>
	4 m (100 mm) (rated value)	<b>E39-R1S</b>	1	
	5 m (100 mm)	<b>E39-R2</b>	1	
	2.5 m (100 mm)	<b>E39-R9</b>	1	
	3.5 m (100 mm)	<b>E39-R10</b>	1	
Fog Preventive Coating	3 m (100 mm)	<b>E39-R1K</b>	1	
Small Reflector	1.5 m (50 mm)	<b>E39-R3</b>	1	
Tape Reflector	700 mm (150 mm)	<b>E39-RS1</b>	1	
	1.1 m (150 mm)	<b>E39-RS2</b>	1	
	1.4 m (150 mm)	<b>E39-RS3</b>	1	

Note: When using a Reflector without a rated value, use 0.7 times typical value as a guideline for the sensing distance.

\* Values in parentheses indicate the minimum required distance between the Sensor and Reflector.



**Mounting Brackets** A Mounting Bracket is not enclosed with the Sensor. Order a Mounting Bracket separately if required.  
 (Refer to *Dimensions* on E39-L/F39-L/E39-S/E39-R.)

Appearance	Model (Material)	Quantity	Remarks	Appearance	Model (Material)	Quantity	Remarks
	E39-L153 (SUS304)	1	Mounting Brackets		E39-L98 (SUS304)	1	Metal Protective Cover Bracket *
	E39-L104 (SUS304)	1			E39-L150 (SUS304)	1 set	(Sensor adjuster)
	E39-L43 (SUS304)	1	Horizontal Mounting Bracket *		E39-L151 (SUS304)	1 set	Easily mounted to the aluminum frame rails of conveyors and easily adjusted.
	E39-L142 (SUS304)	1	Horizontal Protective Cover Bracket *				For left to right adjustment
	E39-L44 (SUS304)	1	Rear Mounting Bracket		E39-L144 (SUS304)	1	Compact Protective Cover Bracket *

Note: When using a Through-beam Sensor, order one Mounting Bracket for the Receiver and one for the Emitter.

\* Cannot be used for Standard Connector models.

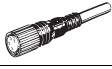
**Sensor I/O Connectors** (Models for Connectors: A Connector is not provided with the Sensor. Be sure to order a Connector separately.)  
 (Refer to *Dimensions* on XS3.)

Size	Cable	Appearance	Cable type	Model	
M8 (4 pins) *	Standard	Straight 	2 m	4-wire	XS3F-M421-402-A
			5 m		XS3F-M421-405-A
		L-shaped 	2 m		XS3F-M422-402-A
			5 m		XS3F-M422-405-A

Note: When using a Through-beam Sensor, order one Mounting Bracket for the Receiver and one for the Emitter.

\* Cable specifications: Outer coating material: PVC, Nut material: Stainless steel, Degree of protection: IP67 (IEC 60529)

## Ratings and Specifications

Sensing method		Through-beam		Retro-reflective with MSR function	Diffuse-reflective Models
Model	NPN output	E3ZM-T61 E3ZM-T66	E3ZM-T63 E3ZM-T68	E3ZM-R61 E3ZM-R66	E3ZM-D62 E3ZM-D67
Item	PNP output	E3ZM-T81 E3ZM-T86	E3ZM-T83 E3ZM-T88	E3ZM-R81 E3ZM-R86	E3ZM-D82 E3ZM-D87
Sensing distance		15 m	0.8 m	4 m [100 mm] (Using E39-R1S) 3 m [100 mm] (Using E39-R1)	1 m (White paper 300 × 300 mm)
Spot diameter (typical)		---			
Standard sensing object		Opaque: 12-mm dia. min.	Opaque: 2-mm dia. min.	Opaque: 75-mm dia. min.	---
Differential travel		---			20% of sensing distance max.
Black/white error		---			
Directional angle		Emitter, Receiver: 3° to 15°		Sensor: 3° to 10° Reflector: 30°	---
Light source (wavelength)		Infrared LED (870 nm)		Red LED (660 nm)	Infrared LED (860 nm)
Power supply voltage		10 to 30 VDC, including 10% ripple (p-p)			
Current consumption		40 mA max. (Emitter 20 mA max., Receiver 20 mA max.)		25 mA max.	
Control output		Load power supply voltage: 30 VDC max., Load current: 100 mA max. (Residual voltage: 2 V max.) Open-collector output (NPN/PNP output depending on model) Light-ON/Dark-ON switch selectable			
Protection circuits		Reversed power supply polarity protection, Output short-circuit protection, and Reversed output polarity protection		Reversed power supply polarity protection, Output short-circuit protection, Mutual interference prevention, and Reversed output polarity protection	
Response time		Operate or reset: 1 ms max.			
Sensitivity adjustment		One-turn adjuster			
Ambient illumination (Receiver side)		Incandescent lamp: 3,000 lx max., Sunlight: 10,000 lx max.			
Ambient temperature range		Operating: -25 to 55°C, Storage: -40 to 70°C (with no icing or condensation)			
Ambient humidity range		Operating: 35% to 85%, Storage: 35% to 95% (with no condensation)			
Insulation resistance		20 MΩ min. at 500 VDC			
Dielectric strength		1,000 VAC, 50/60 Hz for 1 min			
Vibration resistance		Destruction: 10 to 55 Hz, 1.5-mm double amplitude for 2 hours each in X, Y, and Z directions			
Shock resistance		Destruction: 500 m/s <sup>2</sup> 3 times each in X, Y, and Z directions			
Degree of protection *		IEC: IP67, DIN 40050-9: IP69K			
Connection method		Pre-wired cable (standard length: 2 m) M8 4-pin Connector			
Indicator		Operation indicator (yellow), Stability indicator (green) (Emitter has only power supply indicator (green).)			
Weight (packed state)	Pre-wired models (with 2-m cable)	Approx. 150 g		Approx. 90 g	
	Connector models	Approx. 60 g		Approx. 40 g	
Materials	Case	SUS316L			
	Lens	PMMA (polymethylmethacrylate)			
	Display	PES (polyethersulfone)			
	Sensitivity adjustment and mode selector switch	PEEK (polyetheretherketone)			
	Seals	Fluoro rubber			
Accessories		Instruction sheet (Note: Reflectors and Mounting Brackets are sold separately.)			

\* IP69K Degree of Protection Specifications

IP69K is a protection specification stipulated by DIN 40050 Part 9 of the German standards.

The test item is sprayed with 80°C water from a nozzle of a specified shape at a water pressure of 80 to 100 bar. The amount of water is 14 to 16 liters per minute.

The distance between the test item and the nozzle is 10 to 15 cm. The water is discharged at angles of 0°, 30°, 60°, and 90° from the horizontal plane for 30 seconds at each angle while the test item is rotated horizontally.

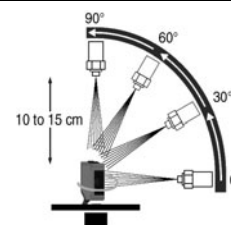

		BGS Reflective Models		
Model	Sensing method			
	NPN output	E3ZM-LS61H E3ZM-LS66H	E3ZM-LS62H E3ZM-LS67H	E3ZM-LS64H E3ZM-LS69H
Item	PNP output	E3ZM-LS81H E3ZM-LS86H	E3ZM-LS82H E3ZM-LS87H	E3ZM-LS84H E3ZM-LS89H
<b>Sensing distance</b>		10 to 100 mm (White paper 100 × 100 mm)	10 to 150 mm (White paper 100 × 100 mm)	10 to 200 mm (White paper 100 × 100 mm)
<b>Spot diameter (typical)</b>		4-mm dia. at sensing distance of 100 mm	12-mm dia. at sensing distance of 150 mm	18-mm dia. at sensing distance of 200 mm
<b>Standard sensing object</b>		---		
<b>Differential travel</b>		3% of sensing distance max.	15% of sensing distance max.	20% of sensing distance max.
<b>Black/white error</b>		5% of sensing distance max.	10% of sensing distance max.	20% of sensing distance max.
<b>Directional angle</b>		---		
<b>Light source (wavelength)</b>		Red LED (650 nm)	Red LED (660 nm)	
<b>Power supply voltage</b>		10 to 30 VDC, including 10% ripple (p-p)		
<b>Current consumption</b>		25 mA max.		
<b>Control output</b>		Load power supply voltage: 30 VDC max., Load current: 100 mA max. (Residual voltage: 2 V max.) Open-collector output (NPN/PNP output depending on model) Light-ON/Dark-ON cable connection selectable		
<b>Protection circuits</b>		Reversed power supply polarity protection, Output short-circuit protection, Reversed output polarity protection, Mutual interference protection		
<b>Response time</b>		Operate or reset: 1 ms max.		
<b>Sensitivity adjustment</b>		---		
<b>Ambient illumination (Receiver side)</b>		Incandescent lamp: 3,000 lx max., Sunlight: 10,000 lx max.		
<b>Ambient temperature range</b>		Operating: -25 to 55°C, Storage: -40 to 70°C (with no icing or condensation)		
<b>Ambient humidity range</b>		Operating: 35% to 85%, Storage: 35% to 95% (with no condensation)		
<b>Insulation resistance</b>		20 MΩ min. at 500 VDC		
<b>Dielectric strength</b>		1,000 VAC, 50/60 Hz for 1 min		
<b>Vibration resistance</b>		Destruction: 10 to 55 Hz, 1.5-mm double amplitude for 2 hours each in X, Y, and Z directions		
<b>Shock resistance</b>		Destruction: 500 m/s <sup>2</sup> 3 times each in X, Y, and Z directions		
<b>Degree of protection *</b>		IEC: IP67, DIN 40050-9: IP69K		
<b>Connection method</b>		Pre-wired cable (standard length: 2 m) M8 4-pin Connector		
<b>Indicator</b>		Operation indicator (yellow), Stability indicator (green)		
<b>Weight (packed state)</b>	<b>Pre-wired models (with 2-m cable)</b>	Approx. 90 g		
	<b>Connector models</b>	Approx. 40 g		
<b>Materials</b>	<b>Case</b>	SUS316L		
	<b>Lens</b>	PMMA (polymethylmethacrylate)		
	<b>Display</b>	PES (polyethersulfone)		
	<b>Seals</b>	Fluoro rubber		
<b>Accessories</b>		Instruction sheet (Note: Mounting Brackets are sold separately.)		

\* IP69K Degree of Protection Specifications

IP69K is a protection specification stipulated by DIN 40050 Part 9 of the German standards.

The test item is sprayed with 80°C water from a nozzle of a specified shape at a water pressure of 80 to 100 bar. The amount of water is 14 to 16 liters per minute.

The distance between the test item and the nozzle is 10 to 15 cm. The water is discharged at angles of 0°, 30°, 60°, and 90° from the horizontal plane for 30 seconds at each angle while the test item is rotated horizontally.

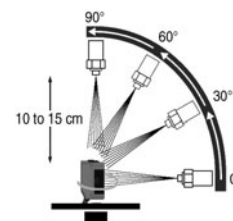

# Engineering Data (Typical)

## Parallel Operating Range Through-beam Models E3ZM-T□1(T□6)

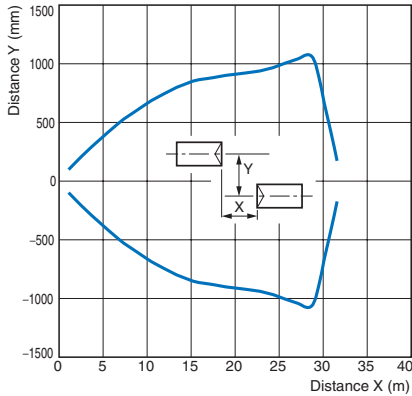

## E3ZM-T□3(T□8)

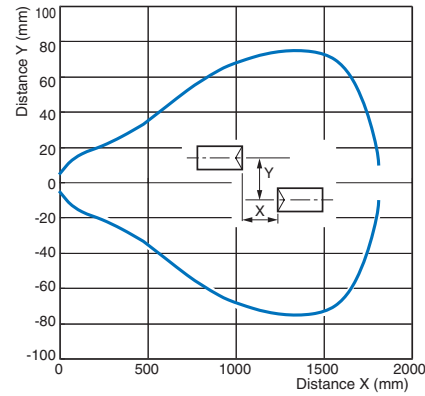

## Retro-reflective Models E3ZM-R□1(R□6)

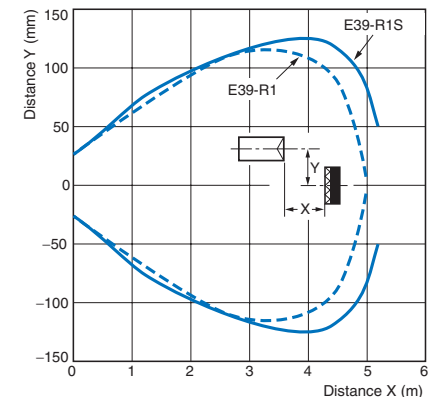

## Operating Range Diffuse-reflective Models E3ZM-D□2(D□7)

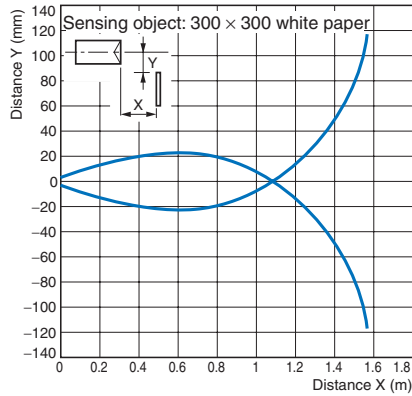

## BGS Reflective Models E3ZM-LS□1H(LS□6H), Top to Bottom

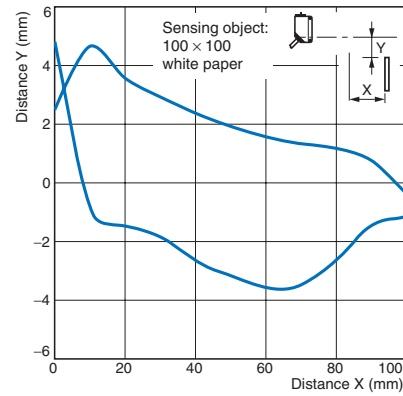

## E3ZM-LS□1H(LS□6H), Left to Right

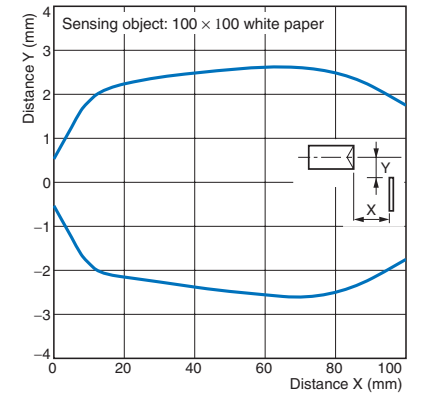

## E3ZM-LS□2H(LS□7H), Top to Bottom

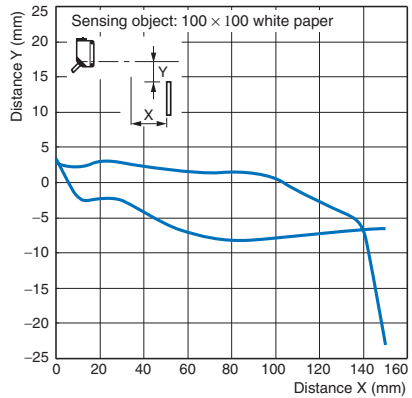

## E3ZM-LS□2H(LS□7H), Left to Right

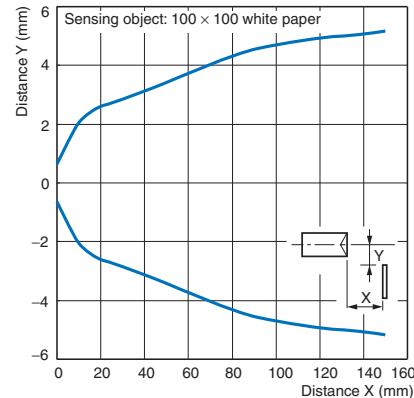

## E3ZM-LS□4H(LS□9H), Top to Bottom

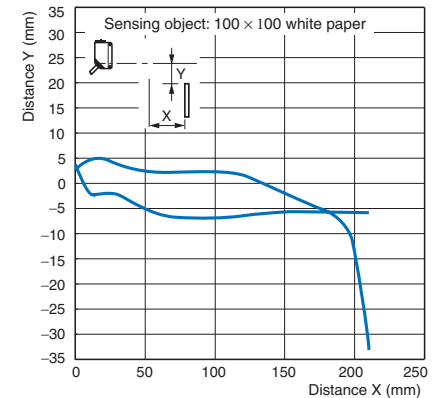

## E3ZM-LS□4H(LS□9H), Left to Right

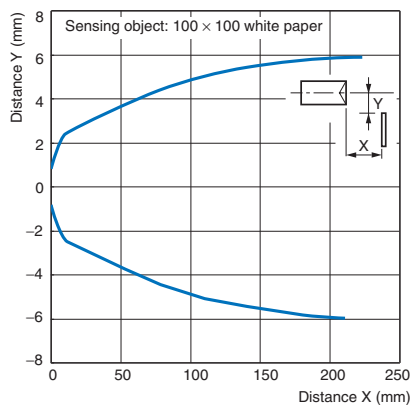

## Excess Gain vs. Distance

### Through-beam Models

#### E3ZM-T□1(T□6)

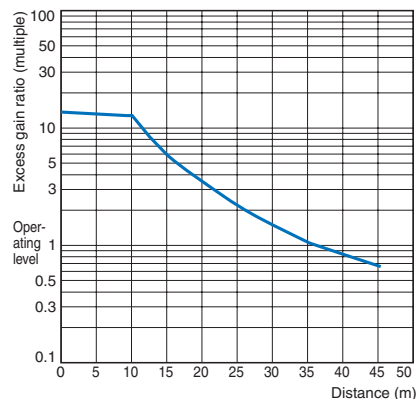

#### E3ZM-T□3(T□8)

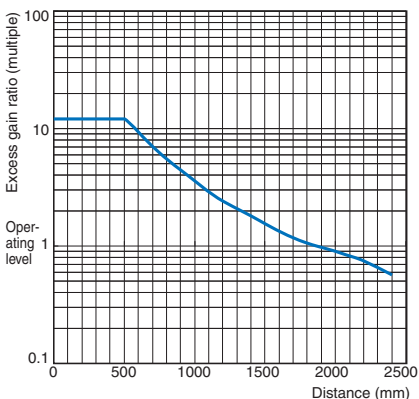

### Retro-reflective Models

#### E3ZM-R□1(R□6)

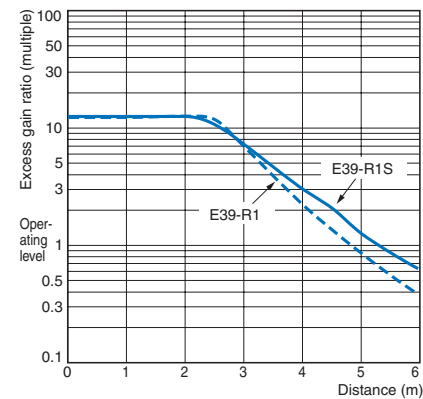

### Diffuse-reflective Models

#### E3ZM-D□2(D□7)

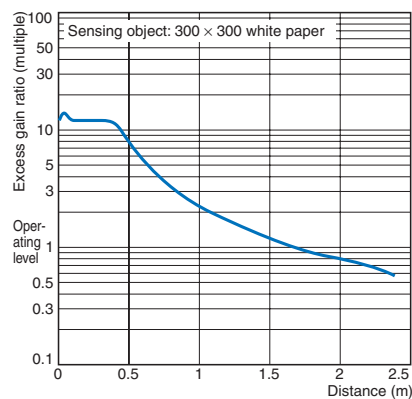

## Sensing Object Size vs. Distance

### Diffuse-reflective Models

#### E3ZM-D□2(D□7)

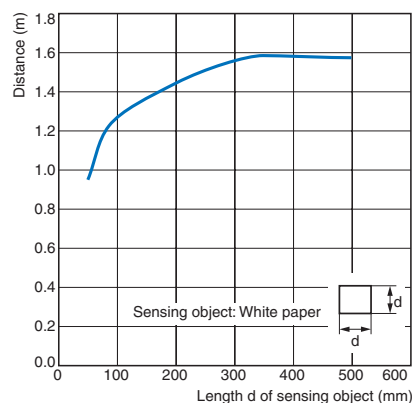

## Spot Diameter vs. Distance

### BGS Reflective Models

#### E3ZM-LS□1H(LS□6H)

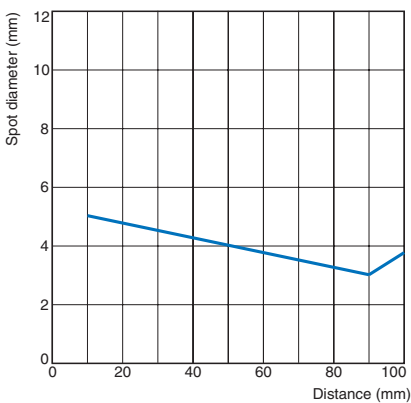

#### E3ZM-LS□2H/LS□4H(LS□7H/LS□9H)

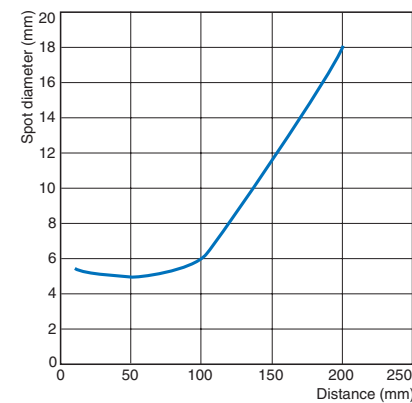



**Sensing Distance vs. Sensing Object Material**

**BGS Reflective Models**

**E3ZM-LS□1H(LS□6H)**

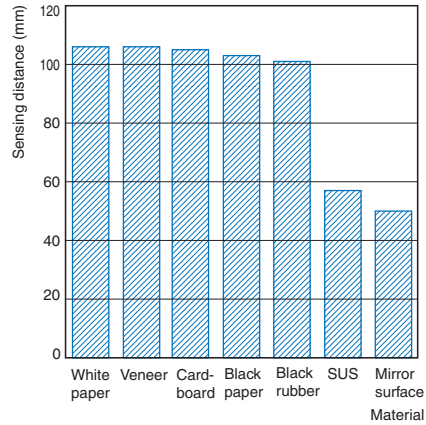

**E3ZM-LS□2H(LS□7H)**

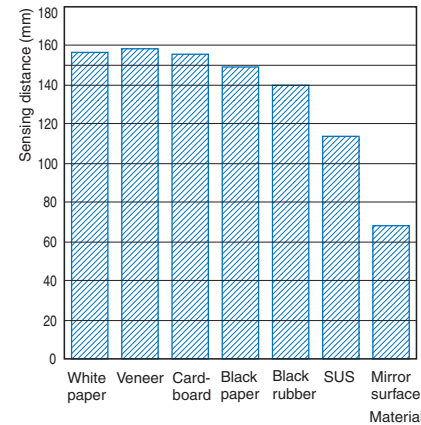

**E3ZM-LS□4H(LS□9H)**

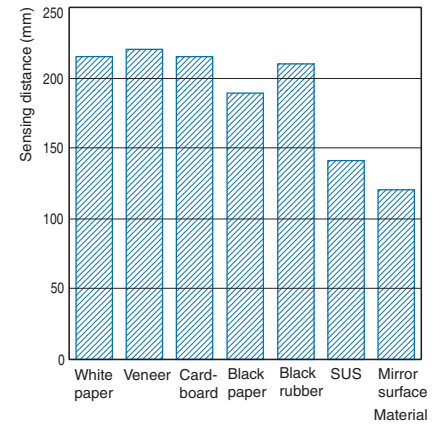

**Inclination Characteristics (Vertical)**

**BGS Reflective Models**

**E3ZM-LS□1H(LS□6H)**

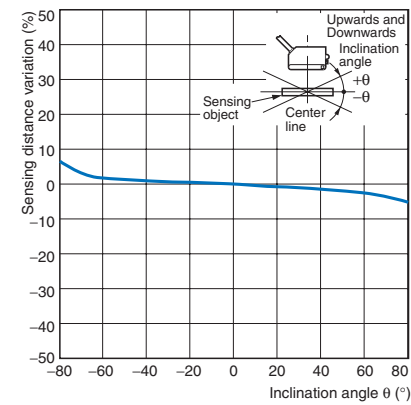

**E3ZM-LS□2H(LS□7H)**

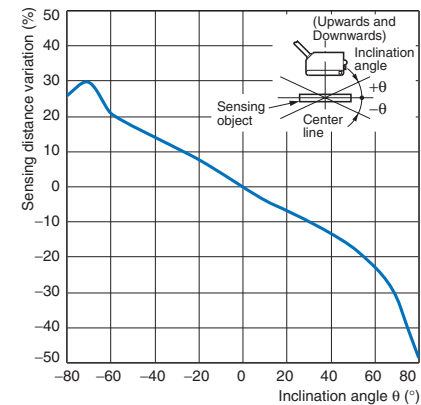

**E3ZM-LS□4H(LS□9H)**

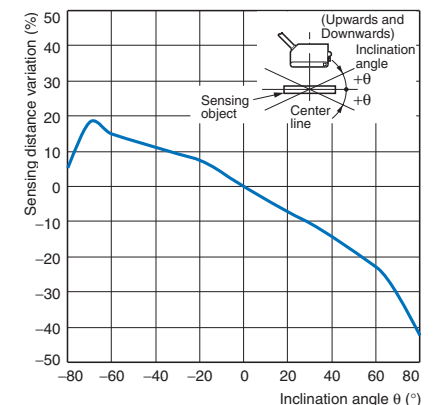

**Inclination Characteristics (Horizontal)**

**BGS Reflective Models**

**E3ZM-LS□1H(LS□6H)**

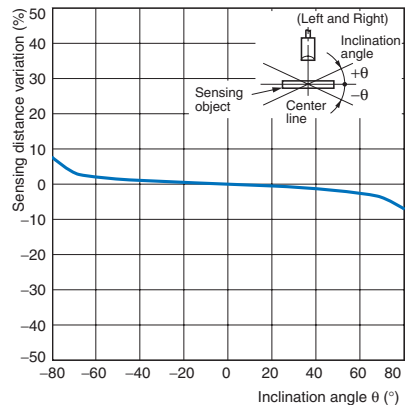

**E3ZM-LS□2H(LS□7H)**

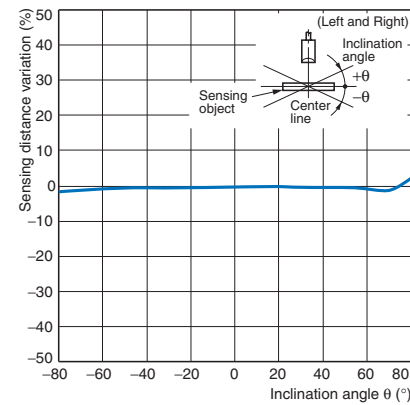

**E3ZM-LS□4H(LS□9H)**

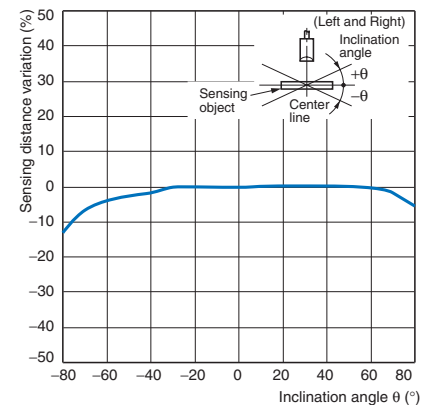

I/O Circuit Diagrams

NPN Output

Model	Operation mode	Timing charts	Operation selector	Output circuit
E3ZM-T61 E3ZM-T63 E3ZM-T66 E3ZM-R61 E3ZM-R66 E3ZM-D62 E3ZM-D67	Light-ON	Light incident: ON Light interrupted: OFF Operation indicator (yellow): ON Output transistor: ON Load (e.g., relay): Operate Reset: OFF (Between brown and black leads)	L side (LIGHT ON)	Through-beam Receivers, Retro-reflective Models, Diffuse-reflective Models 
	Dark-ON	Light incident: ON Light interrupted: OFF Operation indicator (yellow): ON Output transistor: OFF Load (e.g., relay): Operate Reset: OFF (Between brown and black leads)	D side (DARK ON)	
Through-beam Emitter 				
E3ZM-T61-G0 E3ZM-T63-G0 E3ZM-T66-G0 E3ZM-T68-G0	---	Light emission stop function: ON OFF: (Between blue (3) and pink (2) leads) Emitter LED: ON OFF: (Between blue (3) and pink (2) leads) Indicator (green): ON OFF: (Between blue (3) and pink (2) leads)	---	Through-beam Emitter 
E3ZM-LS61H E3ZM-LS66H E3ZM-LS62H E3ZM-LS67H E3ZM-LS64H E3ZM-LS69H	Light-ON	Operation indicator (yellow): ON Output transistor: ON Load (e.g., relay): Operate Reset: OFF (Between brown and black leads)	Connect pink lead (2) to brown lead (1).	
	Dark-ON	Operation indicator (yellow): ON Output transistor: OFF Load (e.g., relay): Operate Reset: OFF (Between brown and black leads)	Connect pink lead (2) to blue lead (3) or leave open.	

## PNP Output

Model	Operation mode	Timing charts	Operation selector	Output circuit
E3ZM-T81 E3ZM-T83 E3ZM-T86 E3ZM-T88 E3ZM-R81 E3ZM-R86 E3ZM-D82 E3ZM-D87	Light-ON		L side (LIGHT ON)	<p>Through-beam Receivers, Retro-reflective Models, Diffuse-reflective Models</p>
	Dark-ON		D side (DARK ON)	
<p>Through-beam Emitter</p>				
E3ZM-T81-G0 E3ZM-T83-G0 E3ZM-T86-G0 E3ZM-T88-G0	---		---	<p>Through-beam Emitter</p>
E3ZM-LS81H E3ZM-LS86H E3ZM-LS82H E3ZM-LS87H E3ZM-LS84H E3ZM-LS89H	Light-ON		Connect pink lead (2) to brown lead (1).	
	Dark-ON		Connect pink lead (2) to blue lead (3) or leave open.	

## Connector Pin Arrangement

### M8 Connector (-CN)/M8 Pre-wired Connector

M8 4-pin Connector Pin Arrangement



### M8 Pre-wired 3-pin Connector

M8 3-pin Connector Pin Arrangement



## Plugs (Sensor I/O Connectors)

### M8 4-pin Connectors

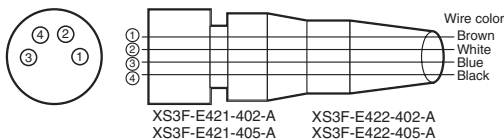

## Nomenclature

### Sensors with Sensitivity Adjustment and Mode Selector Switch

#### Through-beam Models

E3ZM-T□□-D (Receiver)

#### Retro-reflective Models

E3ZM-R□□

#### Diffuse-reflective Models

E3ZM-D□□

### Infinite Adjustment Emitter

#### BGS Reflective Models

E3ZM-LS□□H

#### Through-beam Models

E3ZM-T□□-L (Emitter)



## Safety Precautions

Refer to *Warranty and Limitations of Liability*.

### WARNING

This product is not designed or rated for ensuring safety of persons. Do not use it for such a purpose.



### CAUTION

Do not use the product with voltage in excess of the rated voltage. Excess voltage may result in malfunction or fire.



Never use the product with an AC power supply. Otherwise, explosion may result.



When cleaning the product, do not apply a concentrated spray of water to one part of the product. Otherwise, parts may become damaged and the degree of protection may be degraded.



High-temperature environments may result in burn injury.



### Precautions for Safe Use

The following precautions must be observed to ensure safe operation of the Sensor.

#### Operating Environment

Do not use the Sensor in an environment where explosive or flammable gas is present.

#### Connecting Connectors

Be sure to hold the connector cover when inserting or removing the connector.

If the XS3F is used, always tighten the connector cover by hand. Do not use pliers.

If the tightening is insufficient, the degree of protection will not be maintained and the Sensor may become loose due to vibration. The appropriate tightening torque is 0.3 to 0.4 N·m.

If other commercially available connectors are used, follow the recommended connector application conditions and recommended tightening torque specifications.

#### Load

Do not use a load that exceeds the rated load.

#### Low-temperature Environments

Do not touch the metal surface with your bare hands when the temperature is low. Touching the surface may result in a cold burn.

#### Rotation Torque for Sensitivity Adjustment and Selector Switch

Adjust with a torque of 0.06 N·m or less.

#### Oily Environments

Do not use the Sensor in oily environments.

#### Modifications

Do not attempt to disassemble, repair, or modify the Sensor.

#### Outdoor Use

Do not use the Sensor in locations subject to direct sunlight.

#### Cleaning

Do not use thinner, alcohol, or other organic solvents. Otherwise, the optical properties and degree of protection may be degraded.

#### Washing

Do not use highly concentrated detergents. They may cause malfunction. Do not use high-pressure water spray in excess of the specifications.

#### Surface Temperature

Burn injury may occur. The Sensor surface temperature rises depending on application conditions, such as the surrounding temperature and the power supply voltage. Use caution when operating or washing the Sensor.

## Precautions for Correct Use

### Do not install the Sensor in the following locations.

- (1) Locations subject to direct sunlight
- (2) Locations subject to condensation due to high humidity
- (3) Locations subject to corrosive gas
- (4) Locations where the Sensor may receive direct vibration or shock

### Connecting and Mounting

- (1) The maximum power supply voltage is 30 VDC. Before turning the power ON, make sure that the power supply voltage does not exceed the maximum voltage.
- (2) Laying Sensor wiring in the same conduit or duct as high-voltage wires or power lines may result in malfunction or damage due to induction. As a general rule, wire the Sensor in a separate conduit or use shielded cable.
- (3) Use an extension cable with a minimum thickness of 0.3 mm<sup>2</sup> and less than 100 m long.
- (4) Do not pull on the cable with excessive force.
- (5) Pounding the Photoelectric Sensor with a hammer or other tool during mounting will impair water resistance. Also, use M3 screws.
- (6) Mount the Sensor either using the bracket (sold separately) or on a flat surface.
- (7) Be sure to turn OFF the power supply before inserting or removing the connector.

### Cleaning

Never use thinner or other solvents. Otherwise, the Sensor surface may be dissolved.

### Power Supply

If a commercial switching regulator is used, ground the FG (frame ground) terminal.

### Power Supply Reset Time

The Sensor will be able to detect objects 100 ms after the power supply is turned ON. Start using the Sensor 100 ms or more after turning ON the power supply. If the load and the Sensor are connected to separate power supplies, be sure to turn ON the Sensor first.

### Turning OFF the Power Supply

Output pulses may be generated even when the power supply is OFF. Therefore, it is recommended to first turn OFF the power supply for the load or the load line.

### Load Short-circuit Protection

This Sensor is equipped with load short-circuit protection, but be sure to not short circuit the load. Be sure to not use an output current flow that exceeds the rated current. If a load short circuit occurs, the output will turn OFF, so check the wiring before turning ON the power supply again. The short-circuit protection circuit will be reset. The load short-circuit protection will operate when the current flow reaches 1.8 times the rated load current. When using a C load, use an inrush current of 1.8 times the rated load current or higher.

### Water Resistance

Do not use the Sensor in water, rainfall, or outdoors.

**When disposing of the Sensor, treat it as industrial waste.**

### Mounting Diagram

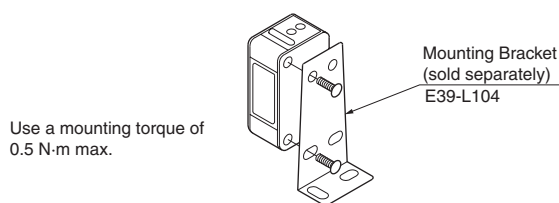

### Resistance to Detergents, Disinfectants, and Chemicals

- Performance is assured for typical detergents and disinfectants, but performance may not be maintained for some detergents and disinfectants. Refer to the following table when using these agents.
- The E3ZM passed testing for resistance to detergents and disinfectants performed using the items in the following table. Refer to this table when considering use of detergents and disinfectants.

Category	Product name	Concentration	Temperature	Time
Chemical	Sodium hydroxide (NaOH)	1.5%	70°C	240h
	Potassium hydroxide (KOH)	1.5%	70°C	240h
	Phosphoric acid (H <sub>3</sub> PO <sub>4</sub> )	2.5%	70°C	240h
	Sodium hypochlorite (NaClO)	0.3%	25°C	240h
	Hydrogen peroxide (H <sub>2</sub> O <sub>2</sub> )	6.5%	25°C	240h
Alkaline foam detergent	P3-topax-66s (Manufactured by Ecolab)	3.0%	70°C	240h
Acidic foam detergent	P3-topax-56 (Manufactured by Ecolab)	5.0%	70°C	240h
Disinfectant	P3-oxonia active 90 (Manufactured by Ecolab)	1.0%	25°C	240h
	TEK121 (Manufactured by ABC Compounding)	1.1%	25°C	240h

Note: The Sensor was immersed in the chemicals, detergents, and disinfectants listed above at the temperatures in the table for 240 hours and then passed an insulation resistance of 100 MΩ min.

## Dimensions

### Sensors

#### Through-beam Models

#### Pre-wired Models

E3ZM-T61(-G0)

E3ZM-T81(-G0)

E3ZM-T63(-G0)

E3ZM-T83(-G0)



Emitter

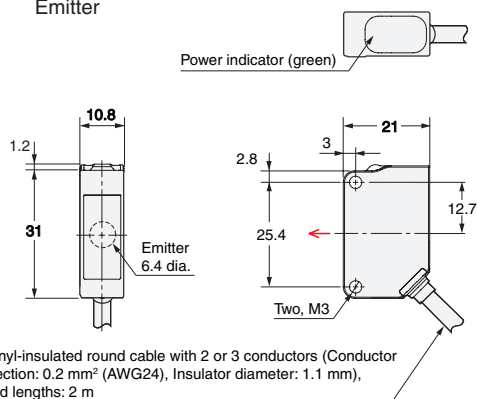

Receiver

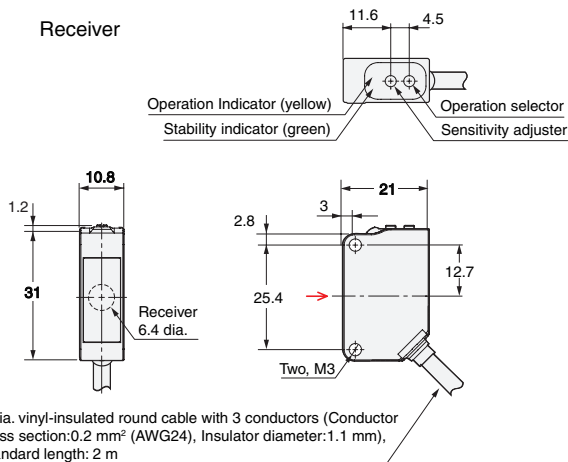

#### Through-beam Models

#### Standard Connector

E3ZM-T66(-G0)

E3ZM-T86(-G0)

E3ZM-T68(-G0)

E3ZM-T88(-G0)



Emitter

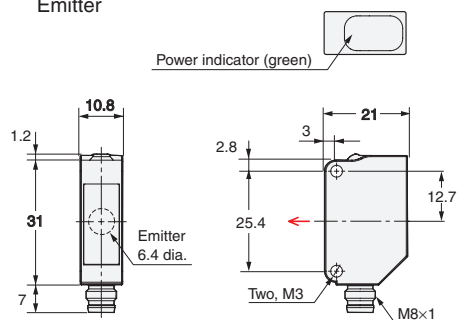

Terminal No.	Specifications
1	+V
2	Light emission stop input (-G0 only)
3	0 V
4	---

Receiver

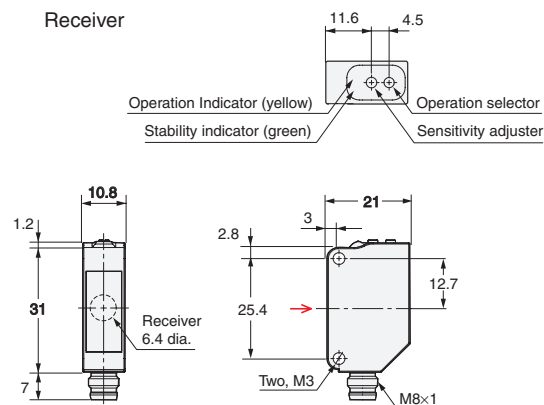

Terminal No.	Specifications
1	+V
2	---
3	0 V
4	Output

**Retro-reflective Models**

**Pre-wired Models**

E3ZM-R61

E3ZM-R81

**Diffuse-reflective Models**

**Standard Connector**

E3ZM-D62

E3ZM-D82

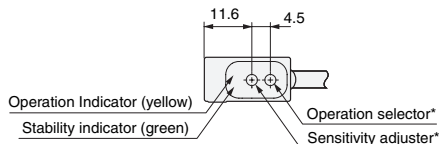

\*No sensitivity adjuster and operation selector with BGS reflective model

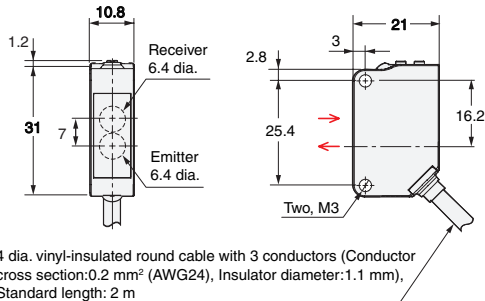

4 dia. vinyl-insulated round cable with 3 conductors (Conductor cross section:0.2 mm<sup>2</sup> (AWG24), Insulator diameter:1.1 mm), Standard length: 2 m

**Retro-reflective Models**

**Standard Connector**

E3ZM-R66

E3ZM-R86

**Diffuse-reflective Models**

**Standard Connector**

E3ZM-D67

E3ZM-D87

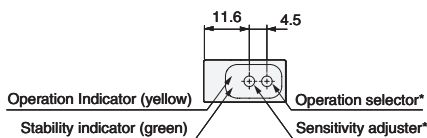

\*No sensitivity adjuster and operation selector with BGS reflective model

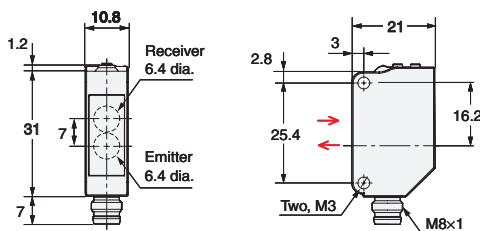

Terminal No.	Specifications
1	+V
2	—
3	0 V
4	Output



## Read and Understand This Catalog

Please read and understand this catalog before purchasing the products. Please consult your OMRON representative if you have any questions or comments.

## Warranty and Limitations of Liability

### WARRANTY

OMRON's exclusive warranty is that the products are free from defects in materials and workmanship for a period of one year (or other period if specified) from date of sale by OMRON.

OMRON MAKES NO WARRANTY OR REPRESENTATION, EXPRESS OR IMPLIED, REGARDING NON-INFRINGEMENT, MERCHANTABILITY, OR FITNESS FOR PARTICULAR PURPOSE OF THE PRODUCTS. ANY BUYER OR USER ACKNOWLEDGES THAT THE BUYER OR USER ALONE HAS DETERMINED THAT THE PRODUCTS WILL SUITABLY MEET THE REQUIREMENTS OF THEIR INTENDED USE. OMRON DISCLAIMS ALL OTHER WARRANTIES, EXPRESS OR IMPLIED.

### LIMITATIONS OF LIABILITY

OMRON SHALL NOT BE RESPONSIBLE FOR SPECIAL, INDIRECT, OR CONSEQUENTIAL DAMAGES, LOSS OF PROFITS OR COMMERCIAL LOSS IN ANY WAY CONNECTED WITH THE PRODUCTS, WHETHER SUCH CLAIM IS BASED ON CONTRACT, WARRANTY, NEGLIGENCE, OR STRICT LIABILITY.

In no event shall the responsibility of OMRON for any act exceed the individual price of the product on which liability is asserted.

IN NO EVENT SHALL OMRON BE RESPONSIBLE FOR WARRANTY, REPAIR, OR OTHER CLAIMS REGARDING THE PRODUCTS UNLESS OMRON'S ANALYSIS CONFIRMS THAT THE PRODUCTS WERE PROPERLY HANDLED, STORED, INSTALLED, AND MAINTAINED AND NOT SUBJECT TO CONTAMINATION, ABUSE, MISUSE, OR INAPPROPRIATE MODIFICATION OR REPAIR.

## Application Considerations

### SUITABILITY FOR USE

OMRON shall not be responsible for conformity with any standards, codes, or regulations that apply to the combination of products in the customer's application or use of the products.

At the customer's request, OMRON will provide applicable third party certification documents identifying ratings and limitations of use that apply to the products. This information by itself is not sufficient for a complete determination of the suitability of the products in combination with the end product, machine, system, or other application or use.

The following are some examples of applications for which particular attention must be given. This is not intended to be an exhaustive list of all possible uses of the products, nor is it intended to imply that the uses listed may be suitable for the products:

- Outdoor use, uses involving potential chemical contamination or electrical interference, or conditions or uses not described in this catalog.
- Nuclear energy control systems, combustion systems, railroad systems, aviation systems, medical equipment, amusement machines, vehicles, safety equipment, and installations subject to separate industry or government regulations.
- Systems, machines, and equipment that could present a risk to life or property.

Please know and observe all prohibitions of use applicable to the products.

NEVER USE THE PRODUCTS FOR AN APPLICATION INVOLVING SERIOUS RISK TO LIFE OR PROPERTY WITHOUT ENSURING THAT THE SYSTEM AS A WHOLE HAS BEEN DESIGNED TO ADDRESS THE RISKS, AND THAT THE OMRON PRODUCTS ARE PROPERLY RATED AND INSTALLED FOR THE INTENDED USE WITHIN THE OVERALL EQUIPMENT OR SYSTEM.

### PROGRAMMABLE PRODUCTS

OMRON shall not be responsible for the user's programming of a programmable product, or any consequence thereof.

## Disclaimers

### CHANGE IN SPECIFICATIONS

Product specifications and accessories may be changed at any time based on improvements and other reasons.

It is our practice to change model numbers when published ratings or features are changed, or when significant construction changes are made. However, some specifications of the products may be changed without any notice. When in doubt, special model numbers may be assigned to fix or establish key specifications for your application on your request. Please consult with your OMRON representative at any time to confirm actual specifications of purchased products.

### DIMENSIONS AND WEIGHTS

Dimensions and weights are nominal and are not to be used for manufacturing purposes, even when tolerances are shown.

### PERFORMANCE DATA

Performance data given in this catalog is provided as a guide for the user in determining suitability and does not constitute a warranty. It may represent the result of OMRON's test conditions, and the users must correlate it to actual application requirements. Actual performance is subject to the OMRON Warranty and Limitations of Liability.

### ERRORS AND OMISSIONS

The information in this document has been carefully checked and is believed to be accurate; however, no responsibility is assumed for clerical, typographical, or proofreading errors, or omissions.

2010.8

In the interest of product improvement, specifications are subject to change without notice.

**OMRON Corporation**  
Industrial Automation Company

<http://www.ia.omron.com/>

(c)Copyright OMRON Corporation 2010 All Right Reserved.

# Mouser Electronics

Authorized Distributor

Click to View Pricing, Inventory, Delivery & Lifecycle Information:

## Omron:

[E3ZM-LS64H 2M](#) [E3ZM-R61 2M](#) [E3ZM-T61 2M](#) [E3ZM-LS61H 2M](#) [E3ZM-D62 2M](#) [E3ZM-LS62H 2M](#) [E3ZM-D67](#)  
[E3ZM-D87](#) [E3ZM-LS66H](#) [E3ZM-LS67H](#) [E3ZM-LS69H](#) [E3ZM-LS81H 2M](#) [E3ZM-LS82H 2M](#) [E3ZM-LS84H 5M](#) [E3ZM-](#)  
[LS86H](#) [E3ZM-LS87H](#) [E3ZM-LS89H](#) [E3ZM-R66](#) [E3ZM-R86](#) [E3ZM-T66](#) [E3ZM-T81 5M](#) [E3ZM-T83 2M](#) [E3ZM-T86](#)  
[E3ZM-T88](#) [E3ZM-B86-C](#)



Компания «ЭлектроПласт» предлагает заключение долгосрочных отношений при поставках импортных электронных компонентов на взаимовыгодных условиях!

Наши преимущества:

- Оперативные поставки широкого спектра электронных компонентов отечественного и импортного производства напрямую от производителей и с крупнейших мировых складов;
- Поставка более 17-ти миллионов наименований электронных компонентов;
- Поставка сложных, дефицитных, либо снятых с производства позиций;
- Оперативные сроки поставки под заказ (от 5 рабочих дней);
- Экспресс доставка в любую точку России;
- Техническая поддержка проекта, помощь в подборе аналогов, поставка прототипов;
- Система менеджмента качества сертифицирована по Международному стандарту ISO 9001;
- Лицензия ФСБ на осуществление работ с использованием сведений, составляющих государственную тайну;
- Поставка специализированных компонентов (Xilinx, Altera, Analog Devices, Intersil, Interpoint, Microsemi, Aeroflex, Peregrine, Syfer, Eurofarad, Texas Instrument, Miteq, Cobham, E2V, MA-COM, Hittite, Mini-Circuits, General Dynamics и др.);

Помимо этого, одним из направлений компании «ЭлектроПласт» является направление «Источники питания». Мы предлагаем Вам помощь Конструкторского отдела:

- Подбор оптимального решения, техническое обоснование при выборе компонента;
- Подбор аналогов;
- Консультации по применению компонента;
- Поставка образцов и прототипов;
- Техническая поддержка проекта;
- Защита от снятия компонента с производства.



#### Как с нами связаться

**Телефон:** 8 (812) 309 58 32 (многоканальный)

**Факс:** 8 (812) 320-02-42

**Электронная почта:** [org@eplast1.ru](mailto:org@eplast1.ru)

**Адрес:** 198099, г. Санкт-Петербург, ул. Калинина, дом 2, корпус 4, литера А.