

Features

- Compact design, long life and high reliability
- Vertical and horizontal mount versions
- Momentary switch
- Dual LED design
- Flatted and knurled shaft styles
- Bushing and bushingless options



PEL12D - 12 mm Encoder with Switch and Illuminated Shaft

Electrical Characteristics

| | |
|---------------------------------|-----------------------|
| Output..... | 2-bit quadrature code |
| Closed Circuit Resistance | 3 ohms maximum |
| Contact Rating..... | 0.5 mA @ 5 VDC |
| Insulation Resistance | 100 megohms @ 250 VDC |
| Dielectric Withstanding Voltage | |
| Sea Level..... | 300 VAC minimum |
| Electrical Travel | Continuous |
| Contact Bounce (15 RPM)..... | 2.0 ms. maximum** |
| RPM (Operating) | 100 maximum** |

Environmental Characteristics

| | |
|-----------------------------------|--------------------------------------|
| Operating Temperature Range | -10 °C to +70 °C (+14 °F to +158 °F) |
| Storage Temperature Range | -40 °C to +85 °C (-40 °F to +185 °F) |
| Operating Humidity..... | 25 % to 85 % R.H. |
| Rotational Life..... | 30,000 cycles minimum |
| Switch Life | 20,000 cycles minimum |
| IP Rating..... | IP 40 |

Mechanical Characteristics

| | |
|-----------------------------|--|
| Mechanical Angle | 360 ° continuous |
| Detent Torque | 30 to 200 g-cm (0.42 to 2.77 oz.-in.) |
| Running Torque | 50 g-cm (0.69 oz.-in.) maximum |
| Shaft Strength (Push)..... | 5 kgf (11.0 lbs.) |
| Shaft Strength (Pull) | 10 kgf (22.0 lbs.) |
| Weight | 3 gm (0.1 oz.) maximum |
| Terminals..... | Printed circuit board terminals |
| Soldering Condition | |
| Wave Soldering..... | Sn95.5/Ag2.8/Cu0.7 solder with no-clean flux: 260 °C max. for 5 ± 1 seconds |
| Hand Soldering | Not recommended |
| Hardware..... | One flat washer and one mounting nut supplied with each encoder with bushing |

Switch Characteristics

| | |
|-------------------------------------|--------------------------------|
| Switch Type | Contact Push ON Momentary SPST |
| Power Rating (Resistive Load) | 10 mA at 5 V DC |
| Contact Resistance | 100 milliohms |
| Switch Travel | 0.5 +0.0/-0.3 mm |
| Switch Actuation Force..... | 450 ± 200 gf (15.9 ± 7.0 oz.) |

How To Order

PEL12D - 4 0 21 F - S 1 024

Model _____

Terminal Configuration _____
 2 = Vertical Mount/Side Exit PC Pin 4 = Horizontal Mount/Rear Exit PC Pin

Detent Option _____
 0 = No Detents 2 = 24 Detents

Standard Shaft Length _____
 Flatted: Knurled:
 16 = 16.0 mm 26 = 26.0 mm 25 = 25.0 mm
 18 = 18.5 mm 31 = 31.0 mm
 21 = 21.0 mm

Shaft Style _____
 F = Insulated Flatted Shaft S = Insulated Knurled Shaft (18 Teeth)
 G = Insulated Flatted Shaft w/Bushing*** T = Insulated Knurled Shaft (18 Teeth) w/Bushing

Switch Configuration _____
 S = Push Momentary Switch

LED Color _____
 Dual:
 1 = Blue/Orange
 2 = Green/Red
 3 = Blue/Green

Resolution _____
 024 = 24 Pulses per 360 ° Rotation

*** Available in 18.5, 21 and 26 mm shaft lengths

*RoHS Directive 2002/95/EC Jan. 27, 2003 including annex and RoHS Recast 2011/65/EU June 8, 2011.

** Devices are tested using standard noise reduction filters. For optimum performance, designers should use noise reduction filters in their circuits.

Specifications are subject to change without notice.

The device characteristics and parameters in this data sheet can and do vary in different applications and actual device performance may vary over time. Users should verify actual device performance in their specific applications.

Applications

Level control, tuning and timer settings in:

- Audio-visual equipment
- Consumer electric appliances
- Musical instrumentation
- Communications equipment

PEL12D - 12 mm Encoder with Switch and Illuminated Shaft BOURNS®

Product Dimensions

PEL12D-4xxxS-Sxxxx (Horizontal Mount w/Dual LED & Switch, Knurled Shaft)

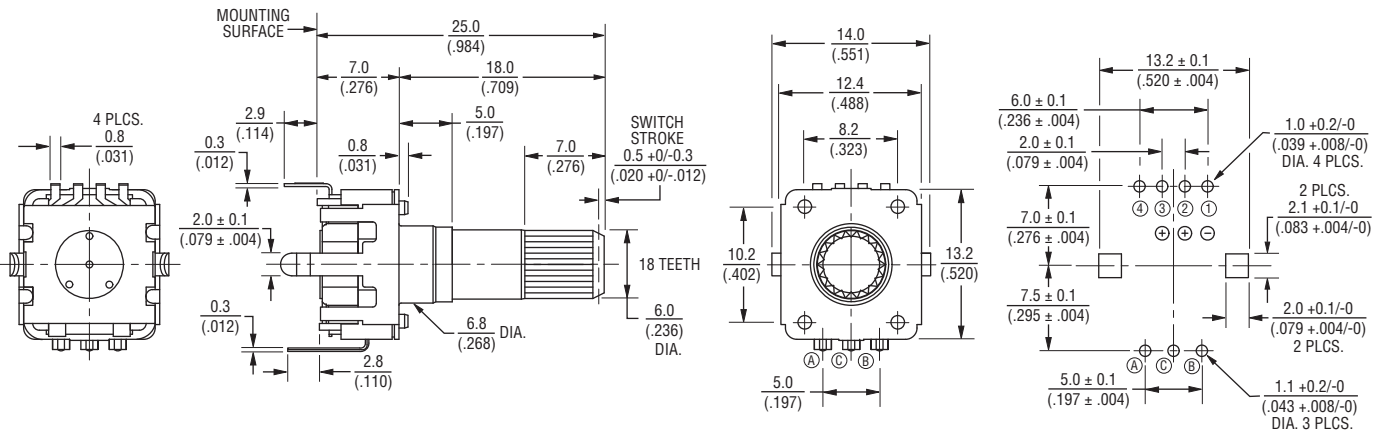

PEL12D-4xxxF-Sxxxx (Horizontal Mount w/Dual LED & Switch, Flatted Shaft)

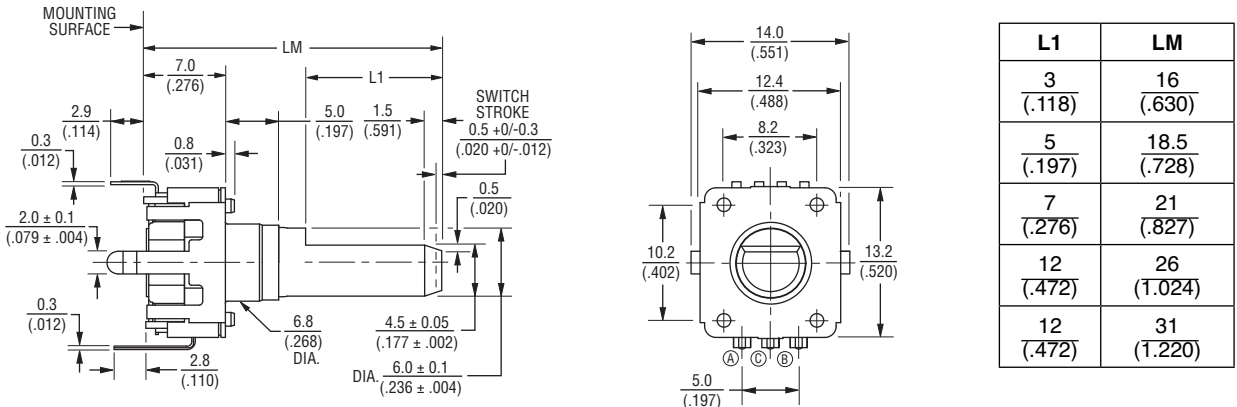

| L1 | LM |
|--------------|----------------|
| 3 (.118) | 16 (.630) |
| 5 (.197) | 18.5 (.728) |
| 7 (.276) | 21 (.827) |
| 12 (.472) | 26 (1.024) |
| 12 (.472) | 31 (1.220) |

DIMENSIONS: $\frac{\text{MM}}{\text{(INCHES)}}$

TOLERANCES:
 UNDER $\frac{10.0}{(.394)} = \frac{\pm 0.3}{(\pm .012)}$ $\frac{10.0 - 100}{(.394 - 3.937)} = \frac{\pm 0.5}{(\pm .020)}$

Dual LED Circuit

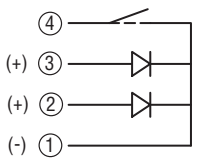

Specifications are subject to change without notice. The device characteristics and parameters in this data sheet can and do vary in different applications and actual device performance may vary over time. Users should verify actual device performance in their specific applications.

PEL12D - 12 mm Encoder with Switch and Illuminated Shaft

BOURNS®

Product Dimensions

PEL12D-2xxxS-Sxxxx (Vertical Mount w/Dual LED & Switch, Knurled Shaft)

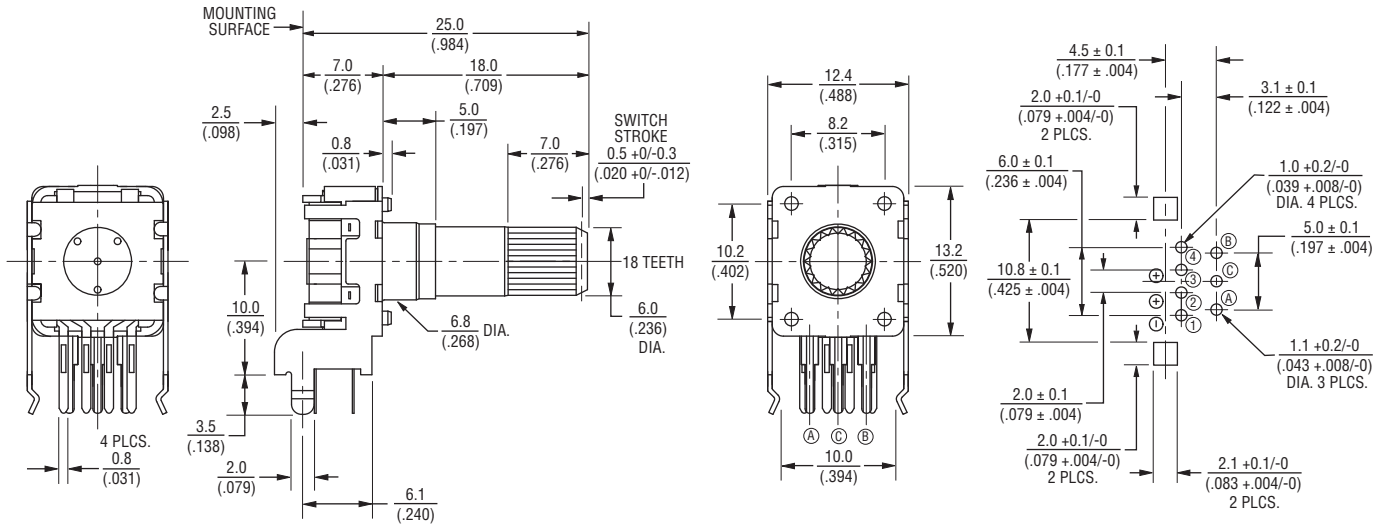

PEL12D-2xxxF-Sxxxx (Vertical Mount w/Dual LED & Switch, Flatted Shaft)

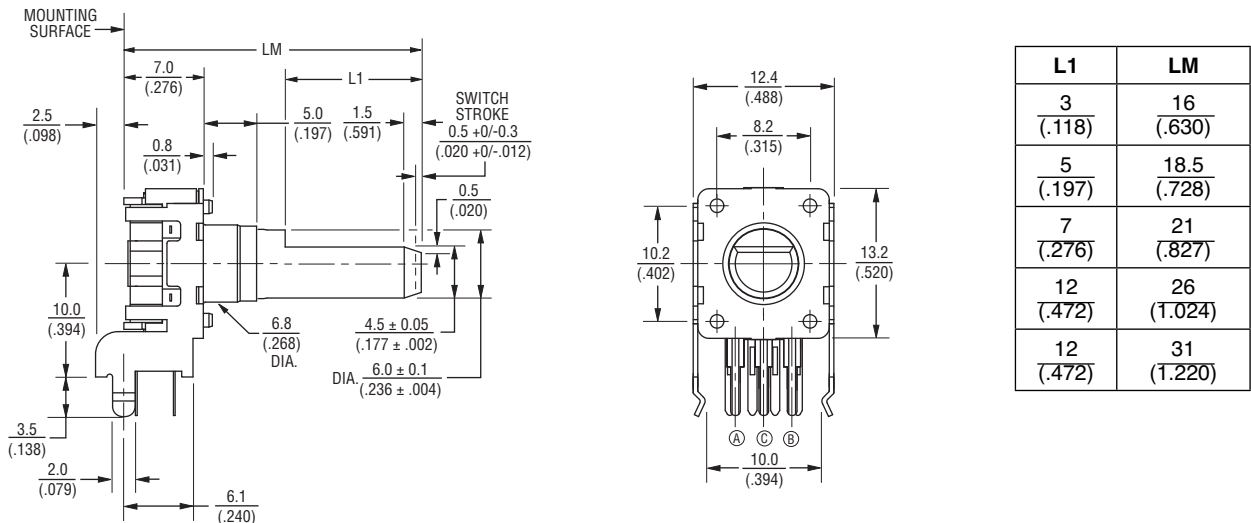

| L1 | LM |
|--------------|----------------|
| 3 (.118) | 16 (.630) |
| 5 (.197) | 18.5 (.728) |
| 7 (.276) | 21 (.827) |
| 12 (.472) | 26 (1.024) |
| 12 (.472) | 31 (1.220) |

DIMENSIONS: $\frac{\text{MM}}{\text{(INCHES)}}$

TOLERANCES:
 UNDER $\frac{10.0}{(.394)} = \frac{\pm 0.3}{(\pm 0.012)}$ $\frac{10.0 - 100}{(.394 - 3.937)} = \frac{\pm 0.5}{(\pm 0.020)}$

Specifications are subject to change without notice.
 The device characteristics and parameters in this data sheet can and do vary in different applications and actual device performance may vary over time.
 Users should verify actual device performance in their specific applications.

PEL12D - 12 mm Encoder with Switch and Illuminated Shaft



Product Dimensions

PEL12D-4xxxT-Sxxxx (Horizontal Mount w/Dual LED & Switch, Knurled Shaft w/Bushing)



PEL12D-4xxxG-Sxxxx (Horizontal Mount w/Dual LED & Switch, Flatted Shaft w/Bushing)



| L2 | L1 | LM |
|--------------|----------------|----------------|
| 5 (.197) | 11 (.433) | 18.5 (.728) |
| 7 (.276) | 13.5 (.532) | 21 (.827) |
| 12 (.472) | 18.5 (.728) | 26 (1.024) |

DIMENSIONS: $\frac{\text{MM}}{\text{(INCHES)}}$

TOLERANCES:
 UNDER $\frac{10.0}{(.394)} = \frac{\pm 0.3}{(\pm 0.012)}$ $\frac{10.0 - 100}{(.394 - 3.937)} = \frac{\pm 0.5}{(\pm 0.020)}$

Quadrature Output Table

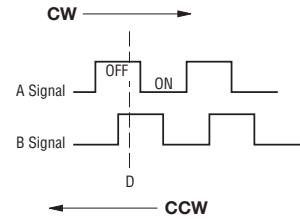

Suggested Filter Circuit

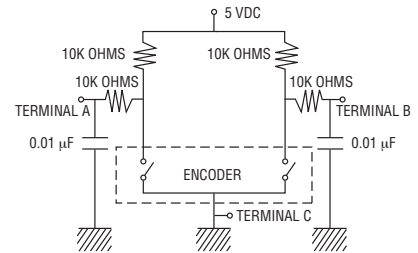

LED Terminal Decoder

| Code | Color | Terminals |
|------|---------------|-----------|
| 1 | Blue / Orange | ① ② / ① ③ |
| 2 | Green / Red | ① ② / ① ③ |
| 3 | Blue / Green | ① ② / ① ③ |

LED Characteristics (Dual)

| LED Color | | Power Dissipation (mW) | DC Forward Current (mA) | Forward Voltage (V) | |
|--------------|--------|------------------------|-------------------------|---------------------|------|
| | | | | Typ. | Max. |
| Blue/ Orange | Blue | 105 | 30 | 3.3 | 4.0 |
| | Orange | 75 | 30 | 2.1 | 2.5 |
| Green/ Red | Green | 120 | 30 | 3.2 | 4.0 |
| | Red | 75 | 30 | 1.95 | 2.5 |
| Blue/ Green | Blue | 120 | 30 | 3.3 | 4.0 |
| | Green | 120 | 30 | 3.2 | 4.0 |
| Red/ Green | Red | 75 | 30 | 1.95 | 2.5 |
| | Green | 120 | 30 | 3.2 | 4.0 |

Notes:

Reverse Current: 10 μ A
 Reverse Voltage: 5 VDC
 Test Condition (IF): 20 mA

The device characteristics and parameters in this data sheet can and do vary in different applications and actual device performance may vary over time. Users should verify actual device performance in their specific applications.



Asia-Pacific:
 Tel: +886-2 2562-4117
 Fax: +886-2 2562-4116

EMEA:
 Tel: +36 88 520 390
 Fax: +36 88 520 211

The Americas:
 Tel: +1-951 781-5500
 Fax: +1-951 781-5700

www.bourns.com



Компания «ЭлектроПласт» предлагает заключение долгосрочных отношений при поставках импортных электронных компонентов на взаимовыгодных условиях!

Наши преимущества:

- Оперативные поставки широкого спектра электронных компонентов отечественного и импортного производства напрямую от производителей и с крупнейших мировых складов;
- Поставка более 17-ти миллионов наименований электронных компонентов;
- Поставка сложных, дефицитных, либо снятых с производства позиций;
- Оперативные сроки поставки под заказ (от 5 рабочих дней);
- Экспресс доставка в любую точку России;
- Техническая поддержка проекта, помощь в подборе аналогов, поставка прототипов;
- Система менеджмента качества сертифицирована по Международному стандарту ISO 9001;
- Лицензия ФСБ на осуществление работ с использованием сведений, составляющих государственную тайну;
- Поставка специализированных компонентов (Xilinx, Altera, Analog Devices, Intersil, Interpoint, Microsemi, Aeroflex, Peregrine, Syfer, Eurofarad, Texas Instrument, Miteq, Cobham, E2V, MA-COM, Hittite, Mini-Circuits, General Dynamics и др.);

Помимо этого, одним из направлений компании «ЭлектроПласт» является направление «Источники питания». Мы предлагаем Вам помощь Конструкторского отдела:

- Подбор оптимального решения, техническое обоснование при выборе компонента;
- Подбор аналогов;
- Консультации по применению компонента;
- Поставка образцов и прототипов;
- Техническая поддержка проекта;
- Защита от снятия компонента с производства.



Как с нами связаться

Телефон: 8 (812) 309 58 32 (многоканальный)

Факс: 8 (812) 320-02-42

Электронная почта: org@eplast1.ru

Адрес: 198099, г. Санкт-Петербург, ул. Калинина, дом 2, корпус 4, литера А.