



## Features

- Compact design, long life and high reliability
- Vertical and horizontal mount versions
- Momentary switch
- Dual LED design
- Flatted and knurled shaft styles
- Bushing and bushingless options



## PEL12D - 12 mm Encoder with Switch and Illuminated Shaft

### Electrical Characteristics

Output.....	2-bit quadrature code
Closed Circuit Resistance .....	3 ohms maximum
Contact Rating.....	0.5 mA @ 5 VDC
Insulation Resistance .....	100 megohms @ 250 VDC
Dielectric Withstanding Voltage	
Sea Level.....	300 VAC minimum
Electrical Travel .....	Continuous
Contact Bounce (15 RPM).....	2.0 ms. maximum**
RPM (Operating) .....	100 maximum**

### Environmental Characteristics

Operating Temperature Range .....	-10 °C to +70 °C (+14 °F to +158 °F)
Storage Temperature Range .....	-40 °C to +85 °C (-40 °F to +185 °F)
Operating Humidity.....	25 % to 85 % R.H.
Rotational Life.....	30,000 cycles minimum
Switch Life .....	20,000 cycles minimum
IP Rating.....	IP 40

### Mechanical Characteristics

Mechanical Angle .....	360 ° continuous
Detent Torque .....	30 to 200 g-cm (0.42 to 2.77 oz.-in.)
Running Torque .....	50 g-cm (0.69 oz.-in.) maximum
Shaft Strength (Push).....	5 kgf (11.0 lbs.)
Shaft Strength (Pull) .....	10 kgf (22.0 lbs.)
Weight .....	3 gm (0.1 oz.) maximum
Terminals.....	Printed circuit board terminals
Soldering Condition	
Wave Soldering.....	Sn95.5/Ag2.8/Cu0.7 solder with no-clean flux: 260 °C max. for 5 ± 1 seconds
Hand Soldering .....	Not recommended
Hardware .....	One flat washer and one mounting nut supplied with each encoder with bushing

### Switch Characteristics

Switch Type .....	Contact Push ON Momentary SPST
Power Rating (Resistive Load) .....	10 mA at 5 V DC
Contact Resistance .....	100 milliohms
Switch Travel .....	0.5 +0.0/-0.3 mm
Switch Actuation Force .....	450 ± 200 gf (15.9 ± 7.0 oz.)

### How To Order

**PEL12D - 4 0 21 F - S 1 024**

Model \_\_\_\_\_

Terminal Configuration \_\_\_\_\_

  2 = Vertical Mount/Side Exit PC Pin      4 = Horizontal Mount/Rear Exit PC Pin

Detent Option \_\_\_\_\_

  0 = No Detents      2 = 24 Detents

Standard Shaft Length \_\_\_\_\_

  Flatted: \_\_\_\_\_      Knurled: \_\_\_\_\_

  16 = 16.0 mm      26 = 26.0 mm      25 = 25.0 mm

  18 = 18.5 mm      31 = 31.0 mm

  21 = 21.0 mm

Shaft Style \_\_\_\_\_

  F = Insulated Flatted Shaft      S = Insulated Knurled Shaft (18 Teeth)

  G = Insulated Flatted Shaft w/Bushing\*\*\*      T = Insulated Knurled Shaft (18 Teeth) w/Bushing

Switch Configuration \_\_\_\_\_

  S = Push Momentary Switch

LED Color \_\_\_\_\_

  Dual: \_\_\_\_\_

  1 = Blue/Orange

  2 = Green/Red

  3 = Blue/Green

Resolution \_\_\_\_\_

  024 = 24 Pulses per 360 ° Rotation

\*\*\* Available in 18.5, 21 and 26 mm shaft lengths

\*RoHS Directive 2002/95/EC Jan. 27, 2003 including annex and RoHS Recast 2011/65/EU June 8, 2011.

\*\* Devices are tested using standard noise reduction filters. For optimum performance, designers should use noise reduction filters in their circuits.

Specifications are subject to change without notice.

The device characteristics and parameters in this data sheet can and do vary in different applications and actual device performance may vary over time. Users should verify actual device performance in their specific applications.

## Applications

Level control, tuning and timer settings in:

- Audio-visual equipment
- Consumer electric appliances
- Musical instrumentation
- Communications equipment

# PEL12D - 12 mm Encoder with Switch and Illuminated Shaft

# BOURNS®

## Product Dimensions

### PEL12D-4xxxS-Sxxxx (Horizontal Mount w/Dual LED & Switch, Knurled Shaft)

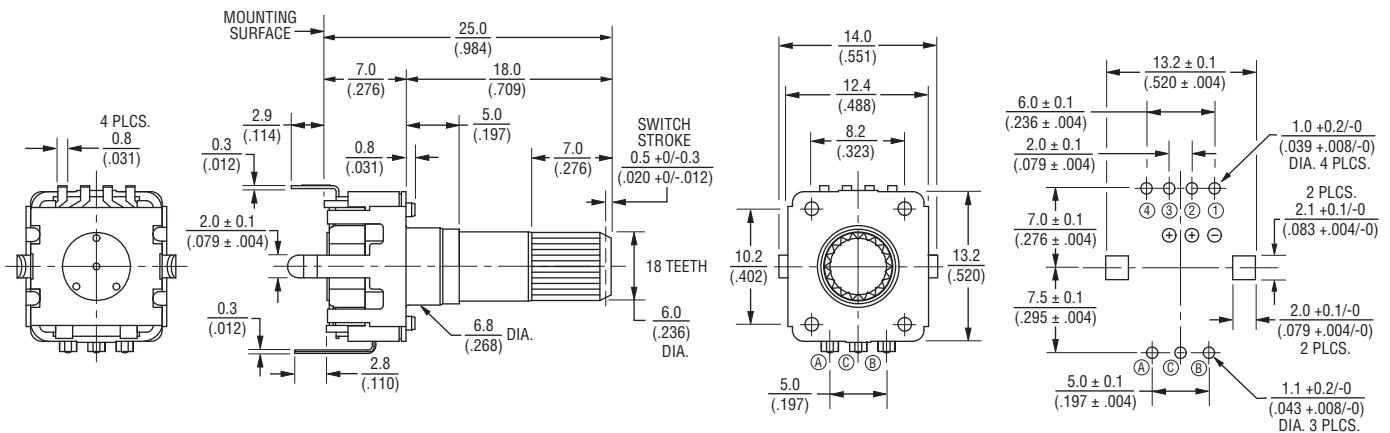

### PEL12D-4xxxF-Sxxxx (Horizontal Mount w/Dual LED & Switch, Flatted Shaft)

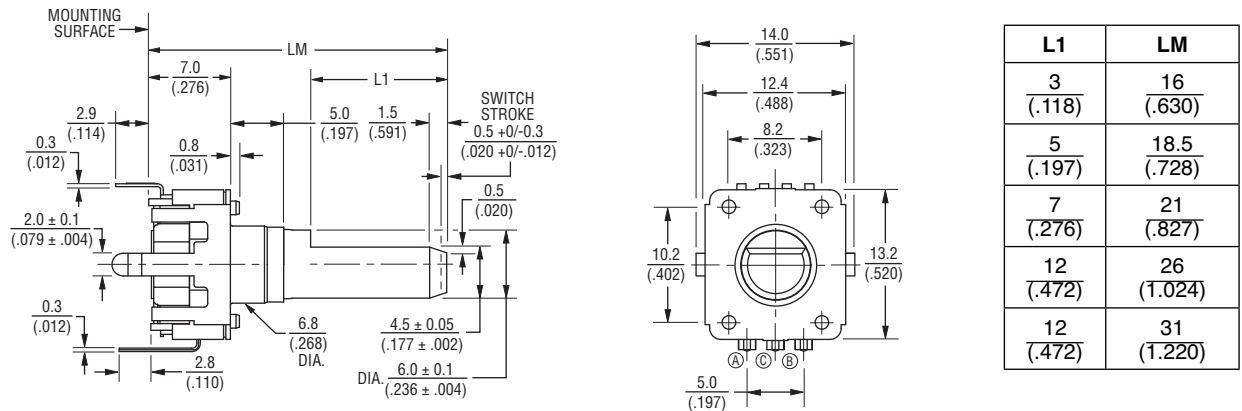

DIMENSIONS:  $\frac{MM}{(INCHES)}$

## Dual LED Circuit

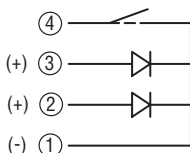

TOLERANCES:  
 UNDER  $\frac{10.0}{(3.94)} = \frac{\pm 0.3}{(\pm 0.012)}$   $\frac{10.0 - 100}{(3.94 - 3.937)} = \frac{\pm 0.5}{(\pm 0.020)}$

# PEL12D - 12 mm Encoder with Switch and Illuminated Shaft



## Product Dimensions

### PEL12D-2xxxS-Sxxxx (Vertical Mount w/Dual LED & Switch, Knurled Shaft)

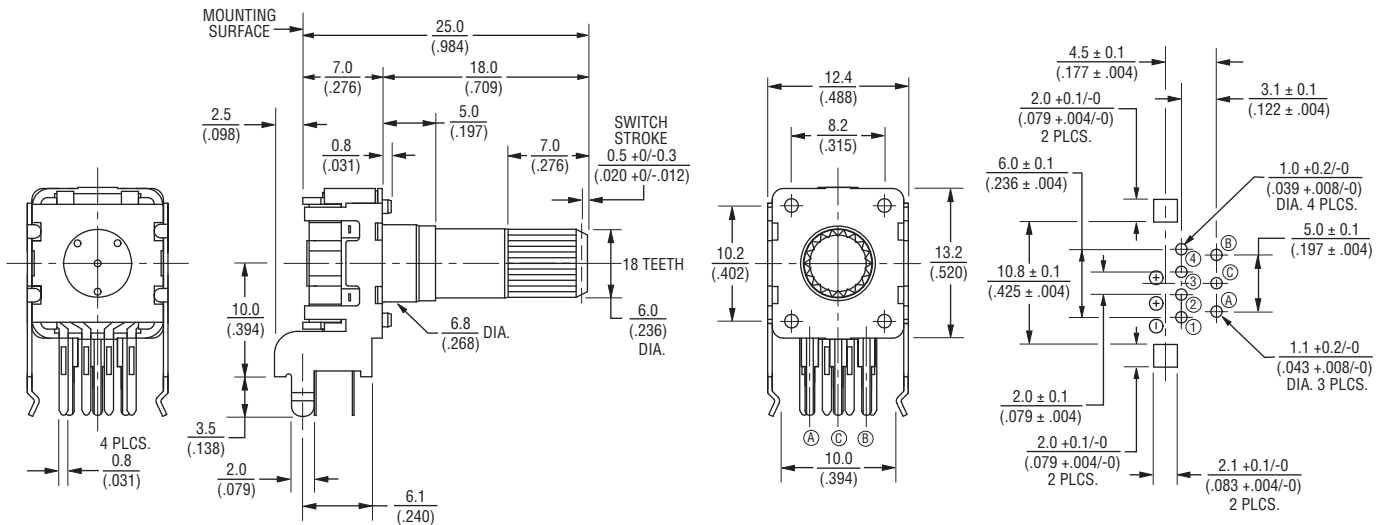

### PEL12D-2xxxF-Sxxxx (Vertical Mount w/Dual LED & Switch, Flatted Shaft)

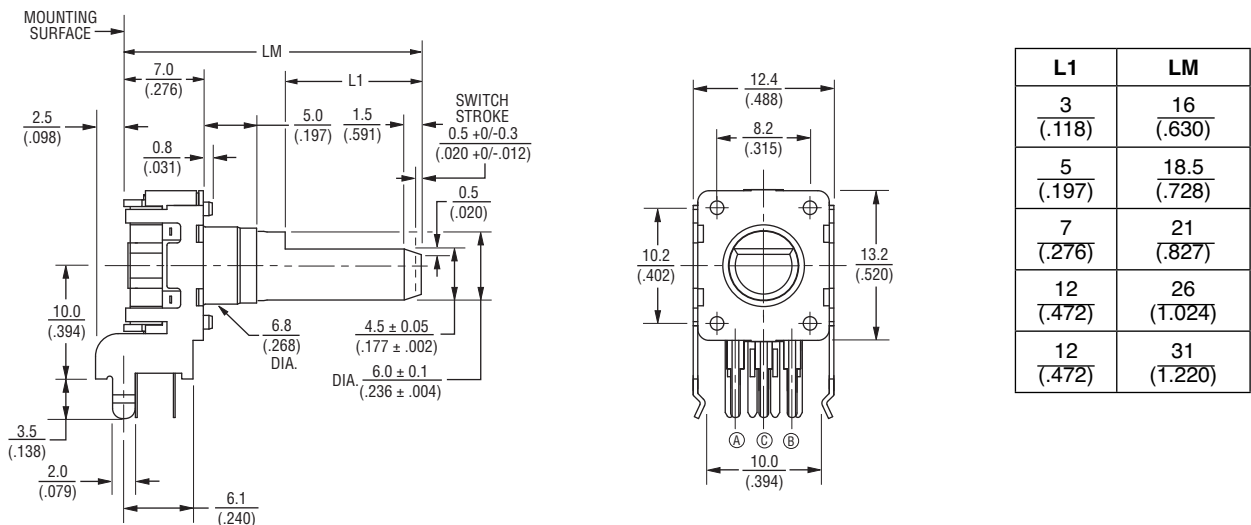

DIMENSIONS:  $\frac{\text{MM}}{\text{(INCHES)}}$

TOLERANCES:  
 UNDER  $\frac{10.0}{(.394)} = \frac{\pm 0.3}{(\pm 0.012)}$   $\frac{10.0 - 100}{(.394 - 3.937)} = \frac{\pm 0.5}{(\pm 0.020)}$

Specifications are subject to change without notice.

The device characteristics and parameters in this data sheet can and do vary in different applications and actual device performance may vary over time. Users should verify actual device performance in their specific applications.

# PEL12D - 12 mm Encoder with Switch and Illuminated Shaft



## Product Dimensions

PEL12D-4xxxT-Sxxxx (Horizontal Mount w/Dual LED & Switch, Knurled Shaft w/Bushing)

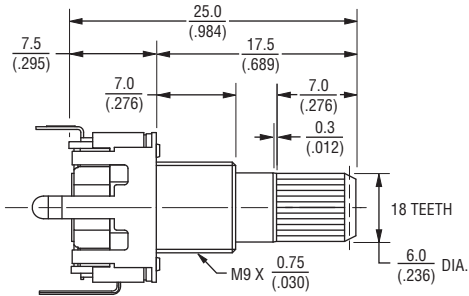

PEL12D-4xxxG-Sxxxx (Horizontal Mount w/Dual LED & Switch, Flatted Shaft w/Bushing)

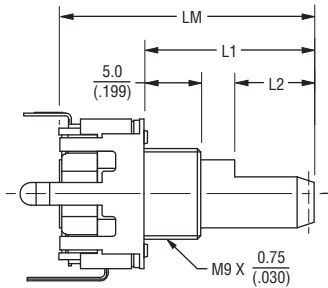

L2	L1	LM
5 (.197)	11 (.433)	18.5 (.728)
7 (.276)	13.5 (.532)	21 (.827)
12 (.472)	18.5 (.728)	26 (1.024)

DIMENSIONS:  $\frac{\text{MM}}{\text{(INCHES)}}$

TOLERANCES:  
 UNDER  $\frac{10.0}{(.394)} = \frac{\pm 0.3}{(\pm .012)}$   $\frac{10.0 - 100}{(.394 - 3.937)} = \frac{\pm 0.5}{(\pm .020)}$

## Quadrature Output Table

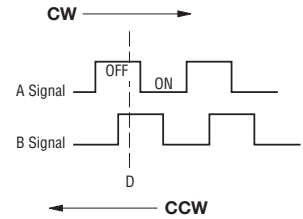

## Suggested Filter Circuit

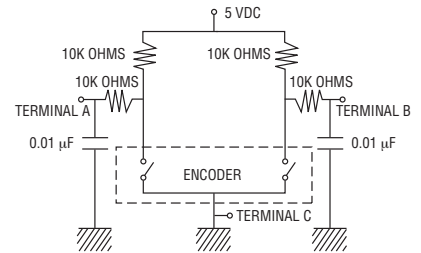

## LED Terminal Decoder

Code	Color	Terminals
1	Blue / Orange	① ② / ① ③
2	Green / Red	① ② / ① ③
3	Blue / Green	① ② / ① ③

## LED Characteristics (Dual)

LED Color		Power Dissipation (mW)	DC Forward Current (mA)	Forward Voltage (V)	
				Typ.	Max.
Blue/ Orange	Blue	105	30	3.3	4.0
	Orange	75	30	2.1	2.5
Green/ Red	Green	120	30	3.2	4.0
	Red	75	30	1.95	2.5
Blue/ Green	Blue	120	30	3.3	4.0
	Green	120	30	3.2	4.0
Red/ Green	Red	75	30	1.95	2.5
	Green	120	30	3.2	4.0

### Notes:

Reverse Current: 10  $\mu$ A  
 Reverse Voltage: 5 VDC  
 Test Condition (IF): 20 mA

The device characteristics and parameters in this data sheet can and do vary in different applications and actual device performance may vary over time. Users should verify actual device performance in their specific applications.



**Asia-Pacific:**  
 Tel: +886-2 2562-4117  
 Fax: +886-2 2562-4116

**EMEA:**  
 Tel: +36 88 520 390  
 Fax: +36 88 520 211

**The Americas:**  
 Tel: +1-951 781-5500  
 Fax: +1-951 781-5700

[www.bourns.com](http://www.bourns.com)



Компания «ЭлектроПласт» предлагает заключение долгосрочных отношений при поставках импортных электронных компонентов на взаимовыгодных условиях!

Наши преимущества:

- Оперативные поставки широкого спектра электронных компонентов отечественного и импортного производства напрямую от производителей и с крупнейших мировых складов;
- Поставка более 17-ти миллионов наименований электронных компонентов;
- Поставка сложных, дефицитных, либо снятых с производства позиций;
- Оперативные сроки поставки под заказ (от 5 рабочих дней);
- Экспресс доставка в любую точку России;
- Техническая поддержка проекта, помощь в подборе аналогов, поставка прототипов;
- Система менеджмента качества сертифицирована по Международному стандарту ISO 9001;
- Лицензия ФСБ на осуществление работ с использованием сведений, составляющих государственную тайну;
- Поставка специализированных компонентов (Xilinx, Altera, Analog Devices, Intersil, Interpoint, Microsemi, Aeroflex, Peregrine, Syfer, Eurofarad, Texas Instrument, Miteq, Cobham, E2V, MA-COM, Hittite, Mini-Circuits, General Dynamics и др.);

Помимо этого, одним из направлений компании «ЭлектроПласт» является направление «Источники питания». Мы предлагаем Вам помощь Конструкторского отдела:

- Подбор оптимального решения, техническое обоснование при выборе компонента;
- Подбор аналогов;
- Консультации по применению компонента;
- Поставка образцов и прототипов;
- Техническая поддержка проекта;
- Защита от снятия компонента с производства.



#### Как с нами связаться

**Телефон:** 8 (812) 309 58 32 (многоканальный)

**Факс:** 8 (812) 320-02-42

**Электронная почта:** [org@eplast1.ru](mailto:org@eplast1.ru)

**Адрес:** 198099, г. Санкт-Петербург, ул. Калинина, дом 2, корпус 4, литера А.