



**PNP SWITCHING SILICON TRANSISTOR**  
**Qualified per MIL-PRF-19500/290**

*Qualified Levels:*  
 JAN, JANTX, JANTXV  
 and JANS

**DESCRIPTION**

This family of 2N2904AL and 2N2905AL switching transistors are military qualified up to the JANS level for high-reliability applications. These devices are also available in a TO-39 package. Microsemi also offers numerous other transistor products to meet higher and lower power ratings with various switching speed requirements in both through-hole and surface-mount packages.

**Important:** For the latest information, visit our website <http://www.microsemi.com>.

**FEATURES**

- JEDEC registered 2N2904 through 2N2905 series.
- JAN, JANTX, JANTXV, and JANS qualifications are available per MIL-PRF-19500/290. (See [part nomenclature](#) for all available options.)
- RoHS compliant versions available (commercial grade only).

**APPLICATIONS / BENEFITS**

- General purpose transistors for high speed switching applications.
- Military and other high-reliability applications.

**MAXIMUM RATINGS**

Parameters / Test Conditions	Symbol	Value	Unit
Collector-Emitter Voltage	$V_{CEO}$	60	V
Collector-Base Voltage	$V_{CBO}$	60	V
Emitter-Base Voltage	$V_{EBO}$	5.0	V
Thermal Resistance Junction-to-Ambient	$R_{\theta JA}$	195	$^{\circ}C/W$
Thermal Resistance Junction-to-Case	$R_{\theta JC}$	50	$^{\circ}C/W$
Collector Current	$I_C$	600	mA
Total Power Dissipation	$P_T$	0.8 3.0	W
		@ $T_A = +25^{\circ}C$ <sup>(1)</sup> @ $T_C = +25^{\circ}C$ <sup>(2)</sup>	
Operating & Storage Junction Temperature Range	$T_J$ and $T_{stg}$	-65 to +200	$^{\circ}C$

- Notes:**
1. For derating, see [figures 1 and 2](#).
  2. For thermal impedance, see [figures 3 and 4](#).

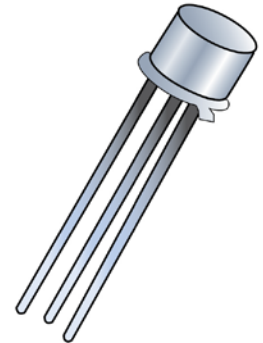

**TO-5 Package**

Also available in:

**TO-39 (TO-205AD) package**  
 (long-leaded)

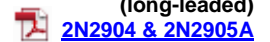

**MSC – Lawrence**  
 6 Lake Street,  
 Lawrence, MA 01841  
 Tel: 1-800-446-1158 or  
 (978) 620-2600  
 Fax: (978) 689-0803

**MSC – Ireland**  
 Gort Road Business Park,  
 Ennis, Co. Clare, Ireland  
 Tel: +353 (0) 65 6840044  
 Fax: +353 (0) 65 6822298

**Website:**  
[www.microsemi.com](http://www.microsemi.com)

**MECHANICAL and PACKAGING**

- CASE: Hermetically sealed, kovar base, nickel cap.
- TERMINALS: Tin/lead plate or RoHS compliant matte/tin (commercial grade only) over nickel.
- MARKING: Part number, date code, manufacturer's ID.
- POLARITY: PNP (see package outline).
- WEIGHT: Approximately 1.14 grams.
- See [Package Dimensions](#) on last page.

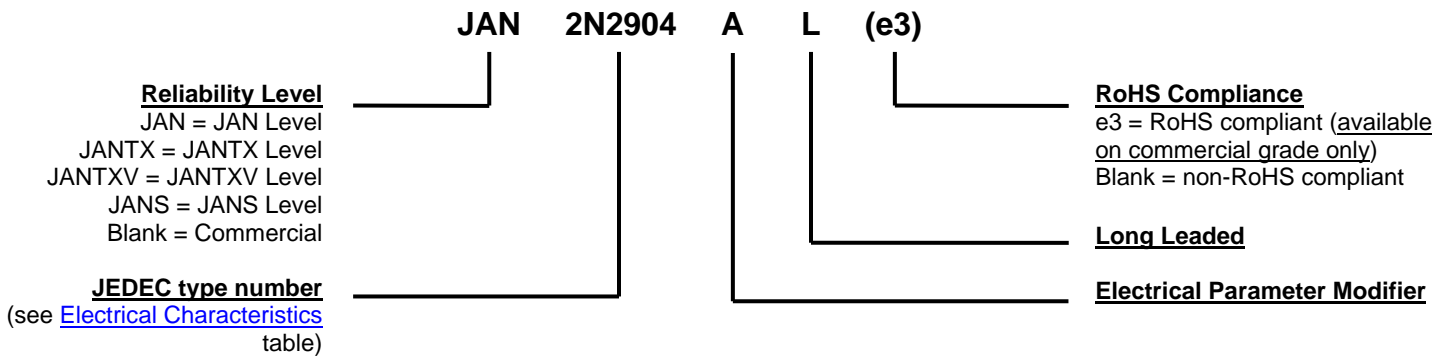
**PART NOMENCLATURE**

**SYMBOLS & DEFINITIONS**

Symbol	Definition
$C_{obo}$	Common-base open-circuit output capacitance.
$I_{CEO}$	Collector cutoff current, base open.
$I_{CEX}$	Collector cutoff current, circuit between base and emitter.
$I_{EBO}$	Emitter cutoff current, collector open.
$h_{FE}$	Common-emitter static forward current transfer ratio.
$V_{CEO}$	Collector-emitter voltage, base open.
$V_{CBO}$	Collector-emitter voltage, emitter open.
$V_{EBO}$	Emitter-base voltage, collector open.

**ELECTRICAL CHARACTERISTICS @  $T_A = +25\text{ }^\circ\text{C}$ , unless otherwise noted**

Parameters / Test Conditions	Symbol	Min.	Max.	Unit
<b>OFF CHARACTERISTICS</b>				
Collector-Emitter Breakdown Current $I_C = 10\text{ mA}$	$V_{(BR)CEO}$	60		V
Collector-Emitter Cutoff Voltage $V_{CE} = 60\text{ V}$	$I_{CES}$		1.0	$\mu\text{A}$
Collector-Base Cutoff Current $V_{CB} = 60\text{ V}$ All Types	$I_{CBO1}$		10	$\mu\text{A}$
$V_{CB} = 50\text{ V}$ 2N2904AL, 2N2905AL	$I_{CBO2}$		10	nA
$V_{CB} = 50\text{ V @ } T_A = +150\text{ }^\circ\text{C}$ 2N2904AL, 2N2905AL	$I_{CBO3}$		10	$\mu\text{A}$
Collector-Base Cutoff Current $V_{CB} = 50\text{ V}$	$I_{CBO}$		10	nA
$V_{CB} = 60\text{ V}$			10	$\mu\text{A}$
Emitter-Base Cutoff Current $V_{EB} = 3.5\text{ V}$	$I_{EBO}$		50	nA
$V_{EB} = 5.0\text{ V}$			10	$\mu\text{A}$

<b>ON CHARACTERISTICS <sup>(1)</sup></b>				
Forward-Current Transfer Ratio $I_C = 0.1\text{ mA}, V_{CE} = 10\text{ V}$	2N2904AL	$h_{FE}$	40	
	2N2905AL		75	
$I_C = 1.0\text{ mA}, V_{CE} = 10\text{ V}$	2N2904AL		40	175
	2N2905AL		100	450
$I_C = 10\text{ mA}, V_{CE} = 10\text{ V}$	2N2904AL		40	
	2N2905AL		100	
$I_C = 150\text{ mA}, V_{CE} = 10\text{ V}$	2N2904AL	40	120	
	2N2905AL	100	300	
$I_C = 500\text{ mA}, V_{CE} = 10\text{ V}$	2N2904AL	40		
	2N2905AL	50		
Collector-Emitter Saturation Voltage $I_C = 150\text{ mA}, I_B = 15\text{ mA}$	$V_{CE(sat)}$		0.4	V
$I_C = 500\text{ mA}, I_B = 50\text{ mA}$			1.6	
Base-Emitter Saturation Voltage $I_C = 150\text{ mA}, I_B = 15\text{ mA}$	$V_{BE(sat)}$		1.3	V
$I_C = 500\text{ mA}, I_B = 50\text{ mA}$			2.6	

(1) Pulse Test: Pulse Width = 300  $\mu\text{s}$ , duty cycle  $\leq 2.0\%$ .

**ELECTRICAL CHARACTERISTICS @  $T_A = +25\text{ }^\circ\text{C}$ , unless otherwise noted (continued)**
**DYNAMIC CHARACTERISTICS**

Parameters / Test Conditions	Symbol	Min.	Max.	Unit
Small-Signal Short-Circuit Forward-Current Transfer Ratio $I_C = 1.0\text{ mA}$ , $V_{CE} = 10\text{ V}$ , $f = 1.0\text{ kHz}$	$h_{fe}$		100	
Small-Signal Short-Circuit Forward-Current Transfer Ratio $I_C = 50\text{ mA}$ , $V_{CE} = 20\text{ V}$ , $f = 100\text{ MHz}$	$ h_{fe} $		2.0	
Output Capacitance $V_{CB} = 10\text{ V}$ , $I_E = 0$ , $100\text{ kHz} \leq f \leq 1.0\text{ MHz}$	$C_{obo}$		8.0	pF
Input Capacitance $V_{EB} = 2.0\text{ V}$ , $I_C = 0$ , $100\text{ kHz} \leq f \leq 1.0\text{ MHz}$	$C_{ibo}$		30	pF

**SWITCHING CHARACTERISTICS**

Parameters / Test Conditions	Symbol	Min.	Max.	Unit
Turn-On Time	$t_{on}$		45	ns
Turn-Off Time	$t_{off}$		300	ns

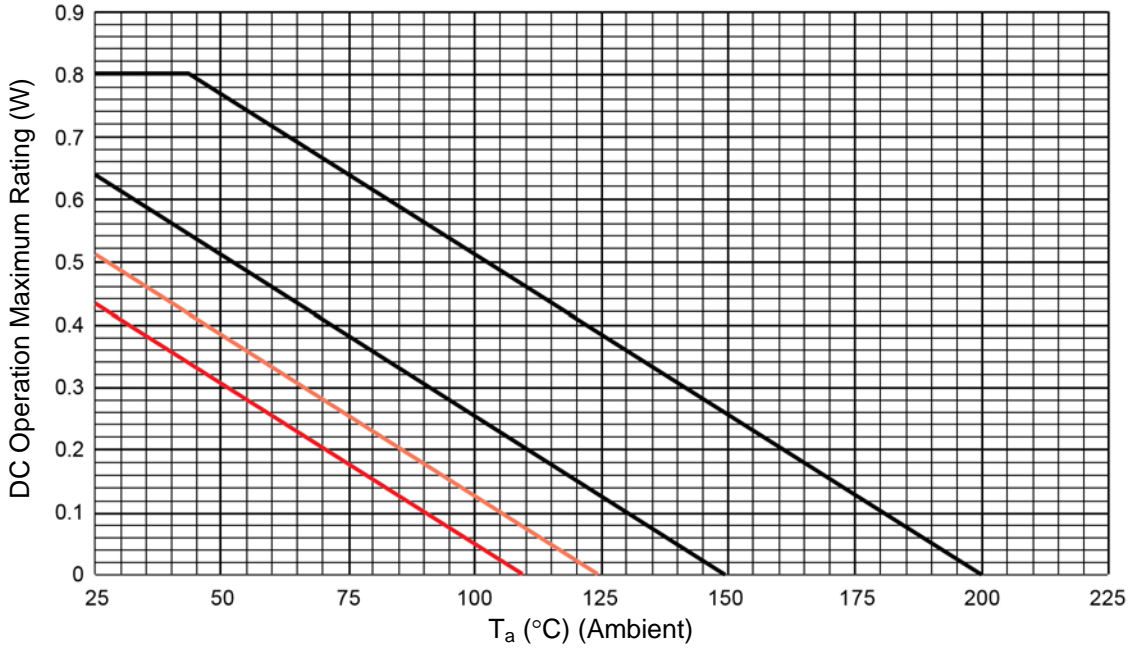
**GRAPHS**

**FIGURE 1**  
Derating (R<sub>θJA</sub>) PCB

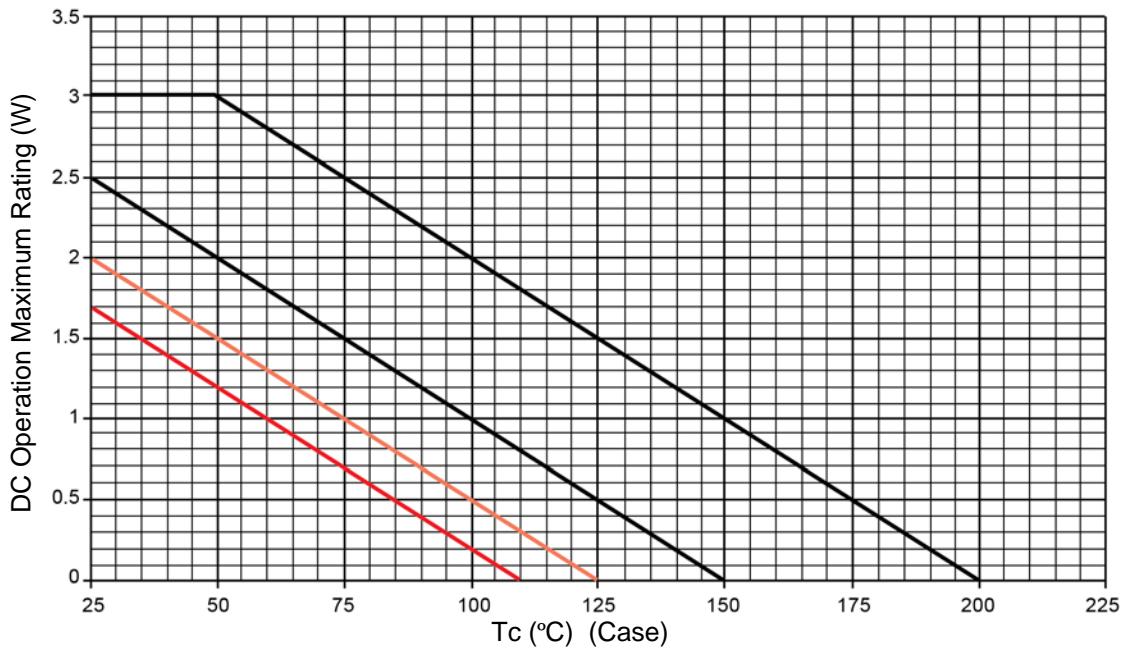

**FIGURE 2**  
Derating (R<sub>θJA</sub>) PCB

GRAPHS (continued)

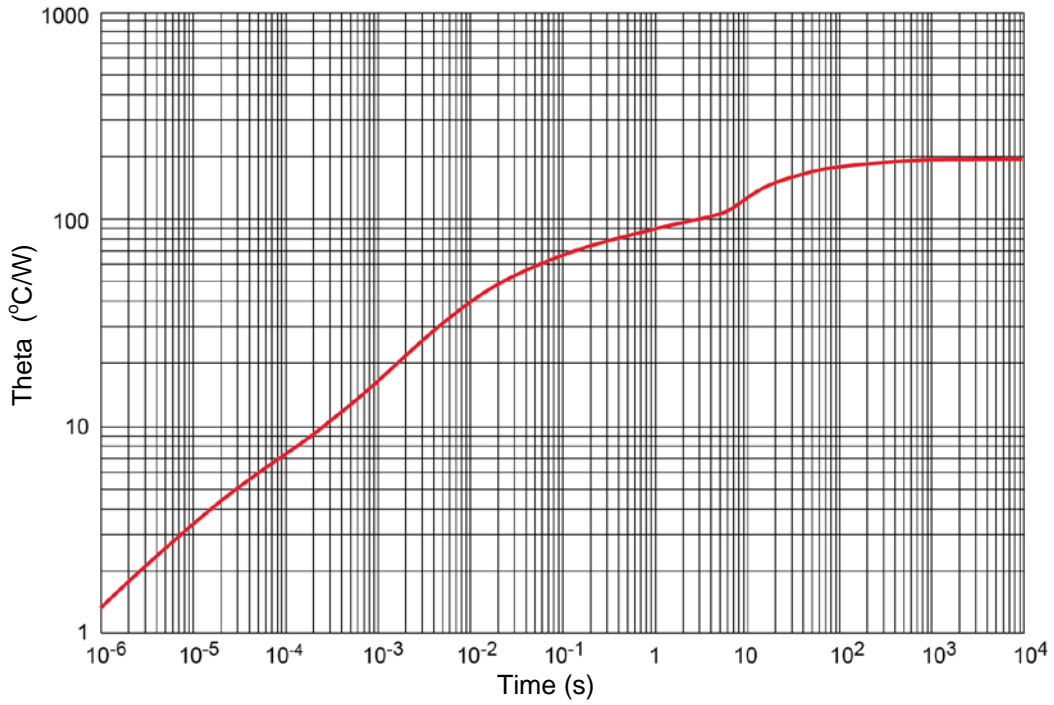

**FIGURE 3**

Thermal impedance graph ( $R_{\theta JA}$ )

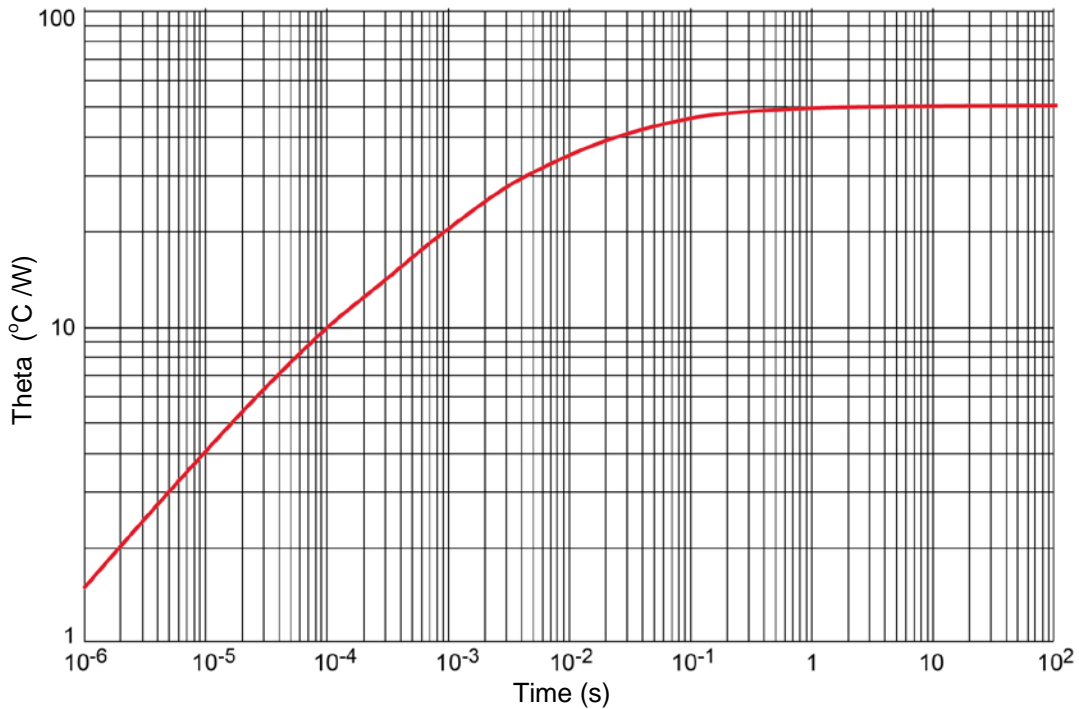

**FIGURE 4**

Thermal impedance graph ( $R_{\theta JA}$ )

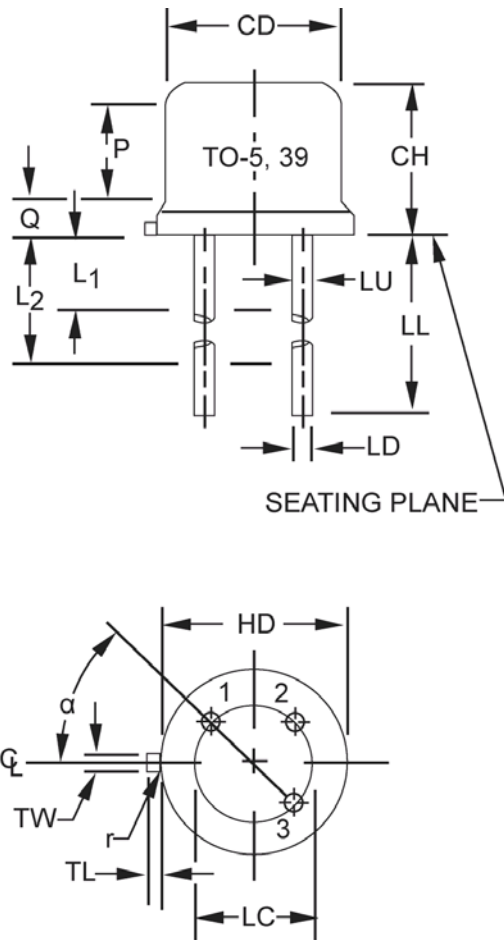
**PACKAGE DIMENSIONS**

Symbol	Dimensions				Note
	Inch		Millimeters		
	Min	Max	Min	Max	
<b>CD</b>	0.305	0.335	7.75	8.51	
<b>CH</b>	0.240	0.260	6.10	6.60	
<b>HD</b>	0.335	0.370	8.51	9.40	
<b>LC</b>	0.200 TP		5.08 TP		6
<b>LD</b>	0.016	0.021	0.41	0.53	7, 8
<b>LL</b>	0.500	0.750	12.70	19.05	7, 8, 12
<b>LU</b>	0.016	0.019	0.41	0.48	7, 8
<b>L1</b>		0.050		1.27	7, 8
<b>L2</b>	0.250		6.35		7, 8
<b>P</b>	0.100		2.54		
<b>Q</b>		0.050		1.27	5
<b>TL</b>	0.029	0.045	0.74	1.14	4
<b>TW</b>	0.028	0.034	0.71	0.86	3
<b>r</b>		0.010		0.25	10
<b><math>\alpha</math></b>	45° TP		45° TP		6

**NOTES:**

1. Dimensions are in inches.
2. Millimeters are given for general information only.
3. Beyond r (radius) maximum, TW shall be held for a minimum length of .011 (0.28 mm).
4. Dimension TL measured from maximum HD.
5. Body contour optional within zone defined by HD, CD, and Q.
6. Leads at gauge plane .054 +.001 -.000 inch (1.37 +0.03 -0.00 mm) below seating plane shall be within .007 inch (0.18 mm) radius of true position (TP) at maximum material condition (MMC) relative to tab at MMC.
7. Dimension LU applies between L1 and L2. Dimension LD applies between L2 and LL minimum. Diameter is uncontrolled in L1 and beyond LL minimum.
8. All three leads.
9. The collector shall be internally connected to the case.
10. Dimension r (radius) applies to both inside corners of tab.
11. In accordance with ASME Y14.5M, diameters are equivalent to  $\Phi$ x symbology.
12. For "L" suffix devices, dimension LL is 1.50 (38.10 mm) minimum, 1.75 (44.45 mm) maximum.
13. Lead 1 = emitter, lead 2 = base, lead 3 = collector.

# Mouser Electronics

Authorized Distributor

Click to View Pricing, Inventory, Delivery & Lifecycle Information:

[Microchip:](#)

[Jan2N2905AL/TR](#) [Jantxv2N2904AL/TR](#) [Jan2N2904AL/TR](#) [Jantx2N2905AL/TR](#) [Jantx2N2904AL/TR](#) [2N2904AL/TR](#)





Компания «ЭлектроПласт» предлагает заключение долгосрочных отношений при поставках импортных электронных компонентов на взаимовыгодных условиях!

Наши преимущества:

- Оперативные поставки широкого спектра электронных компонентов отечественного и импортного производства напрямую от производителей и с крупнейших мировых складов;
- Поставка более 17-ти миллионов наименований электронных компонентов;
- Поставка сложных, дефицитных, либо снятых с производства позиций;
- Оперативные сроки поставки под заказ (от 5 рабочих дней);
- Экспресс доставка в любую точку России;
- Техническая поддержка проекта, помощь в подборе аналогов, поставка прототипов;
- Система менеджмента качества сертифицирована по Международному стандарту ISO 9001;
- Лицензия ФСБ на осуществление работ с использованием сведений, составляющих государственную тайну;
- Поставка специализированных компонентов (Xilinx, Altera, Analog Devices, Intersil, Interpoint, Microsemi, Aeroflex, Peregrine, Syfer, Eurofarad, Texas Instrument, Miteq, Cobham, E2V, MA-COM, Hittite, Mini-Circuits, General Dynamics и др.);

Помимо этого, одним из направлений компании «ЭлектроПласт» является направление «Источники питания». Мы предлагаем Вам помощь Конструкторского отдела:

- Подбор оптимального решения, техническое обоснование при выборе компонента;
- Подбор аналогов;
- Консультации по применению компонента;
- Поставка образцов и прототипов;
- Техническая поддержка проекта;
- Защита от снятия компонента с производства.



#### Как с нами связаться

**Телефон:** 8 (812) 309 58 32 (многоканальный)

**Факс:** 8 (812) 320-02-42

**Электронная почта:** [org@eplast1.ru](mailto:org@eplast1.ru)

**Адрес:** 198099, г. Санкт-Петербург, ул. Калинина, дом 2, корпус 4, литера А.