

# MAX13234E–MAX13237E

# 3Mbps RS-232 Transceivers with Low-Voltage Interface, ±15kV HBM ESD

## General Description

The MAX13234E–MAX13237E are a family of 2x2 and 1x1 RS-232 and V.28/V.24 transceivers with high speed data rates up to 3Mbps that operate from either a 3.3V or 5V supply.

All devices achieve a 1µA supply current using Maxim's AutoShutdown Plus™ feature. These devices automatically enter a low-power shutdown mode when the RS-232 cable is disconnected or the devices driving the transmitter and receiver inputs are inactive for more than 30s.

The MAX13234E–MAX13237E are available in space-saving TQFN and TSSOP packages and operate over the -40°C to +85°C temperature range.

## Applications

- Telematics
- GPS Systems
- Industrial Systems
- Portable Devices
- Wireless Modules
- POS Systems
- Communication Systems
- Data Cables

## Benefits and Features

- Data Rate Up to 3Mbps for Faster Throughput
- Saves Board Space
  - Integrated Low-Voltage Logic for Easy Interface with ASICs and Microcontrollers
  - Integrated ±15kV HBM ESD Protection
  - Integrated Charge-Pump Circuitry Requiring Only Four External 0.1µF Capacitors for 3.3V Operation
- +3V to +5.5V Supply Voltage
- AutoShutdown Plus Achieves 1µA Shutdown Current Reduces Power Consumption
- Available in 20-pin TSSOP, TQFN-EP, and 16-pin TQFN
- -40°C to +85°C Operating Temperature

## Functional Diagrams



## Ordering Information/Selector Guide

PART	DRIVERS/RECEIVERS	MAXIMUM DATA RATE	TEMP RANGE	PIN-PACKAGE
<b>MAX13234E</b> EUP+	2 x 2	250kbps	-40°C to +85°C	20 TSSOP
MAX13234EEETP+	2 x 2	250kbps	-40°C to +85°C	20 TQFN-EP*
<b>MAX13235E</b> EUP+	2 x 2	3Mbps	-40°C to +85°C	20 TSSOP
MAX13235EEETP+	2 x 2	3Mbps	-40°C to +85°C	20 TQFN-EP*
<b>MAX13236E</b> EETE+	1 x 1	250kbps	-40°C to +85°C	16 TQFN-EP*
<b>MAX13237E</b> EETE+	1 x 1	3Mbps	-40°C to +85°C	16 TQFN-EP*

+Denotes a lead-free/RoHS-compliant package.

\*EP = Exposed pad.

### Absolute Maximum Ratings

(All voltages referenced to GND.)

V <sub>CC</sub> .....	-0.3V to +6.0V
V <sub>L</sub> .....	-0.3V to +6.0V
V <sub>+</sub> .....	-0.3V to +7.0V
V <sub>-</sub> .....	+0.3V to -7.0V
(V <sub>+</sub> ) +  I(V <sub>-</sub> )  .....	+13.0V
T <sub>IN</sub> , FORCEOFF, FORCEON .....	-0.3V to (V <sub>L</sub> + 0.3V)
R <sub>IN</sub> .....	±25V
T <sub>OUT</sub> .....	±13.2V
R <sub>OUT</sub> , READY .....	-0.3V to (V <sub>L</sub> + 0.3V)
Short-Circuit Duration	
T <sub>OUT</sub> to GND .....	Continuous
Continuous Power Dissipation (T <sub>A</sub> = +70°C)	
16-Pin TQFN (derate 20.8mW/°C above +70°C) .....	1666mW
20-Pin TSSOP (derate 10.9mW/°C above +70°C) .....	879mW
20-Pin TQFN (derate 21.3mW/°C above +70°C) .....	1702mW

Junction-to-Case Thermal Resistance (θ<sub>JC</sub>) (Note 1)

16-Pin TQFN .....	2°C/W
20-Pin TSSOP .....	20°C/W
20-Pin TQFN .....	2°C/W

Junction-to-Ambient Thermal Resistance (θ<sub>JA</sub>) (Note 1)

16-Pin TQFN .....	30°C/W
20-Pin TSSOP .....	73°C/W
20-Pin TQFN .....	29°C/W

Operating Temperature Range

MAX1323x Operating Temperature Range ....	-40°C to +85°C
MAX1323x Operating Temperature Range ..	-40°C to +105°C
Storage Temperature Range .....	-65°C to +160°C
Lead Temperature (soldering, 10s) .....	+300°C

**Note 1:** Package thermal resistances were obtained using the method described in JEDEC specification JESD51-7, using a four-layer board. For detailed information on package thermal considerations, refer to [www.maximintegrated.com/thermal-tutorial](http://www.maximintegrated.com/thermal-tutorial).

Stresses beyond those listed under “Absolute Maximum Ratings” may cause permanent damage to the device. These are stress ratings only, and functional operation of the device at these or any other conditions beyond those indicated in the operational sections of the specifications is not implied. Exposure to absolute maximum rating conditions for extended periods may affect device reliability.

### Electrical Characteristics

(V<sub>CC</sub> = +3V to +5.5V, V<sub>L</sub> = +1.62V to V<sub>CC</sub>, T<sub>A</sub> = -40°C to +85°C, C1–C4 = 0.1µF, V<sub>CC</sub> = V<sub>L</sub>, tested at 3.3V ±10%. Typical values are at T<sub>A</sub> = +25°C.) (Note 2)

PARAMETER	SYMBOL	CONDITIONS	MIN	TYP	MAX	UNITS
Supply Voltage	V <sub>CC</sub>		3		5.5	V
Logic Supply Voltage	V <sub>L</sub>		1.62		V <sub>CC</sub>	V
V <sub>CC</sub> Supply Current	I <sub>CC</sub>	FORCEOFF = FORCEON = V <sub>L</sub> , no loads		0.3	1	mA
		V <sub>L</sub> = 0V		1	10	
		AutoShutDown Plus, FORCEOFF = V <sub>L</sub> , FORCEON = GND, all R <sub>IN</sub> idle, all T <sub>IN</sub> idle.		1	10	µA
V <sub>CC</sub> Shutdown Current	I <sub>CCSH</sub>	FORCEOFF = GND		1	10	µA
V <sub>L</sub> Supply Current	I <sub>L</sub>	V <sub>CC</sub> = +5.5V		1	10	µA
V <sub>L</sub> Shutdown Current	I <sub>LSH</sub>	FORCEOFF = GND		1	10	µA
<b>LOGIC INPUTS (T<sub>IN</sub>, FORCEON, FORCEOFF, Referred to V<sub>L</sub>)</b>						
Input Threshold Low	V <sub>IL</sub>	Tested at room temperature only			1/3 x V <sub>L</sub>	V
Input Threshold High	V <sub>IH</sub>	Tested at room temperature only	2/3 x V <sub>L</sub>			V
Input Hysteresis				60		mV
Input Leakage Current				±0.01	±1	µA
<b>RECEIVER OUTPUTS (READY)</b>						
Output-Voltage Low	V <sub>OL</sub>	I <sub>OUT</sub> = 0.8mA			0.4	V
Output-Voltage High	V <sub>OH</sub>	I <sub>OUT</sub> = -0.5mA	V <sub>L</sub> - 0.6	V <sub>L</sub> - 0.1		V

**Electrical Characteristics (continued)**

( $V_{CC} = +3\text{V}$  to  $+5.5\text{V}$ ,  $V_L = +1.62\text{V}$  to  $V_{CC}$ ,  $T_A = -40^\circ\text{C}$  to  $+85^\circ\text{C}$ ,  $C_1\text{--}C_4 = 0.1\mu\text{F}$ ,  $V_{CC} = V_L$ , tested at  $3.3\text{V} \pm 10\%$ . Typical values are at  $T_A = +25^\circ\text{C}$ .) (Note 2)

PARAMETER	SYMBOL	CONDITIONS	MIN	TYP	MAX	UNITS	
<b>RECEIVER INPUTS</b>							
Input-Voltage Range			-25		+25	V	
Input Threshold Low	$V_{IL}$	$T_A = +25^\circ\text{C}$	$V_{CC} = +3.3\text{V}$	0.6	1.2	V	
			$V_{CC} = +5\text{V}$	0.8	1.5		
Input Threshold High	$V_{IH}$	$T_A = +25^\circ\text{C}$	$V_{CC} = +3.3\text{V}$		1.5	2.4	V
			$V_{CC} = +5\text{V}$		1.8	2.4	
Input Hysteresis				0.5		V	
Input Resistance			3	5	7	$\text{k}\Omega$	
<b>TRANSMITTER OUTPUTS</b>							
Output-Voltage Swing		All transmitter outputs loaded with $3\text{k}\Omega$ to GND	$\pm 5$	$\pm 5.4$		V	
Output Resistance		$V_{CC} = V_+ = V_- = 0\text{V}$ , transmitter outputs = $\pm 2\text{V}$	300	10M		$\Omega$	
Output Short-Circuit Current			-60		+60	mA	
Output Leakage Current		$V_{CC} = 0\text{V}$ or $+3\text{V}$ to $+5.5\text{V}$ , $V_{OUT} = \pm 12\text{V}$ , transmitters disabled	-25		+25	$\mu\text{A}$	
<b>AutoShutdown Plus (FORCEON = GND, FORCEOFF = <math>V_L</math>)</b>							
Receiver Input Threshold Valid Level		Positive threshold, Figure 1			2.7	V	
		Negative threshold, Figure 1	-2.7			V	
Receiver Input Threshold Invalid Level		Figure 1	-0.3		+0.3	V	
Receiver or Transmitter Edge-to-Transmitters Enabled	$t_{WU}$	$V_L = 5\text{V}$ , Figure 1 (Note 3)		100		$\mu\text{s}$	
Receiver or Transmitter Edge-to-Transmitters Shutdown	$t_{AUTOSHDN}$	$V_L = 5\text{V}$ , Figure 1 (Note 3)	15	30	60	s	
<b>TIMING CHARACTERISTICS (MAX13234E/MAX13236E)</b>							
Maximum Data Rate		$R_L = 3\text{k}\Omega$ , $C_L = 1000\text{pF}$ , one transmitter switching	250			kbps	
Receiver Propagation Delay	$t_{RPHL}$ , $t_{RPLH}$	$C_L = 150\text{pF}$ , Figures 2, 3		0.15		$\mu\text{s}$	
Transmitter Skew	$ t_{TPHL} - t_{TPLH} $	Figures 4, 5 (Note 4)		100		ns	
Receiver Skew	$ t_{RPHL} - t_{RPLH} $	Figures 2, 3		50		ns	

**Electrical Characteristics (continued)**

( $V_{CC} = +3\text{V}$  to  $+5.5\text{V}$ ,  $V_L = +1.62\text{V}$  to  $V_{CC}$ ,  $T_A = -40^\circ\text{C}$  to  $+85^\circ\text{C}$ ,  $C_1$ – $C_4 = 0.1\mu\text{F}$ ,  $V_{CC} = V_L$ , tested at  $3.3\text{V} \pm 10\%$ . Typical values are at  $T_A = +25^\circ\text{C}$ .) (Note 2)

PARAMETER	SYMBOL	CONDITIONS	MIN	TYP	MAX	UNITS
Transition-Region Slew Rate		$V_{CC} = +3.3\text{V}$ , $T_A = +25^\circ\text{C}$ , $R_L = 3\text{k}\Omega$ to $7\text{k}\Omega$ , measured from $+3\text{V}$ to $-3\text{V}$ or $-3\text{V}$ to $+3\text{V}$ , one transmitter switching, $C_L = 150\text{pF}$ to $1000\text{pF}$	6		30	$\text{V}/\mu\text{s}$
<b>TIMING CHARACTERISTICS (MAX13235E/MAX13237E)</b>						
Maximum Data Rate		$R_L = 3\text{k}\Omega$ , $C_L = 250\text{pF}$ , one transmitter switching	1			Mbps
		$R_L = 3\text{k}\Omega$ , $C_L = 150\text{pF}$ , one transmitter switching	3			
Receiver Propagation Delay	$t_{RPHL}$ , $t_{RPLH}$	$C_L = 150\text{pF}$ , Figures 2, 3		0.15		$\mu\text{s}$
Transmitter Skew	$ t_{TPHL} - t_{TPLH} $	Figures 4, 5 (Note 4)		25		ns
Receiver Skew	$ t_{RPHL} - t_{RPLH} $	Figures 2, 3		50		ns
Transition-Region Slew Rate		$V_{CC} = +3.3\text{V}$ , $T_A = +25^\circ\text{C}$ , $R_L = 3\text{k}\Omega$ to $7\text{k}\Omega$ , measured from $T_{OUT} = +3\text{V}$ to $-3\text{V}$ or $-3\text{V}$ to $+3\text{V}$ , one transmitter switching, $C_L = 150\text{pF}$ to $1000\text{pF}$	24		150	$\text{V}/\mu\text{s}$
<b>ESD PROTECTION</b>						
$R_{IN}$ , $T_{OUT}$ to GND		Human Body Model		$\pm 15$		kV
		IEC 61000-4-2 Air Discharge		$\pm 15$		
		IEC 61000-4-2 Contact Discharge		$\pm 8$		

**Note 2:** All devices are 100% production tested at  $T_A = +85^\circ\text{C}$ . All temperature limits are guaranteed by design.

**Note 3:** A transmitter/receiver edge is defined as a transition through the transmitter/receiver input-logic thresholds.

**Note 4:** Transmitter skew is measured at the transmitter zero cross points.

Test Circuits/Timing Diagram



Figure 1. AutoShutdown Plus, and READY Timing Diagram



Figure 2. Receiver Test Circuit

Test Circuits/Timing Diagram (continued)



Figure 3. Receiver Propagation Delay



Figure 4. Transmitter Test Circuit



Figure 5. Transmitter Propagation Delay

Typical Operating Characteristics

( $V_{CC} = V_L = 3.3\text{V}$ ,  $T_A = +25^\circ\text{C}$ , unless otherwise noted.)

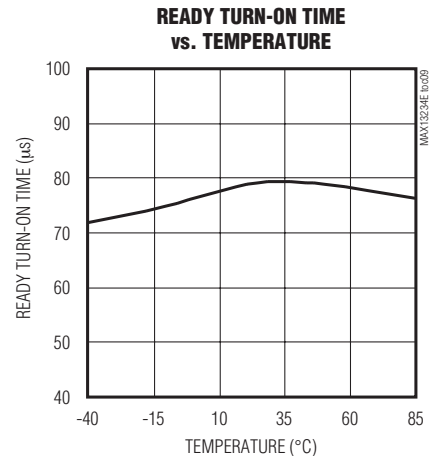
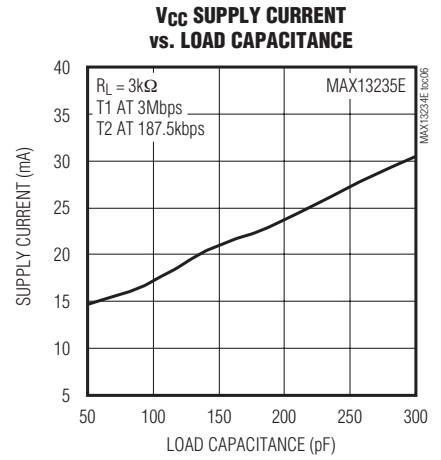
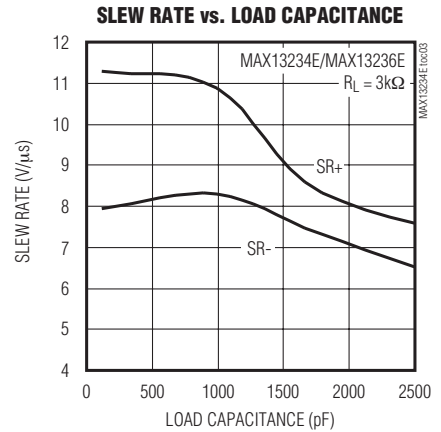

Typical Operating Characteristics (continued)

( $V_{CC} = V_L = 3.3V$ ,  $T_A = +25^\circ C$ , unless otherwise noted.)

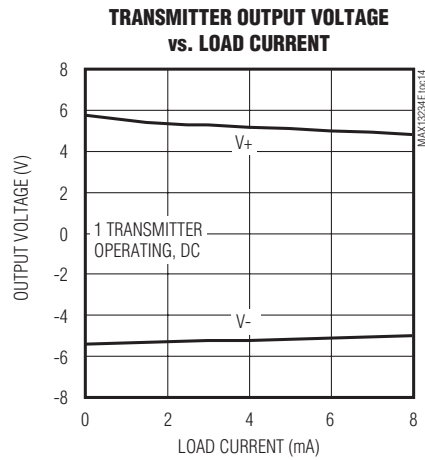
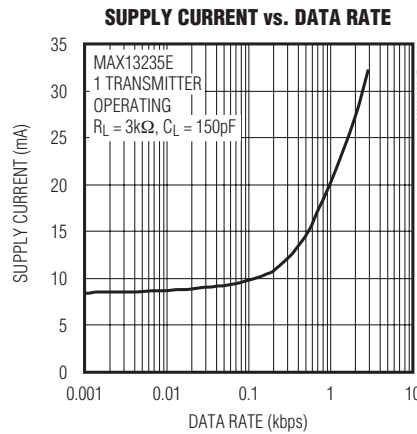
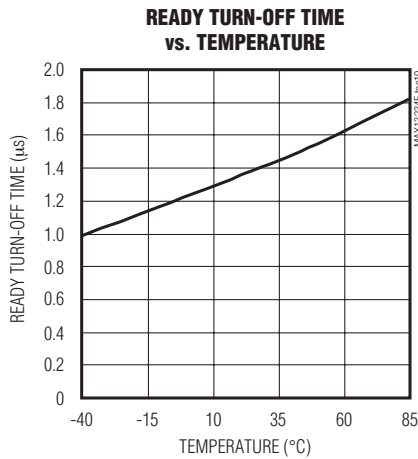



## Pin Descriptions

PIN			NAME	FUNCTION
MAX13234E/ MAX13235E		MAX13236E/ MAX13237E		
TSSOP	TQFN-EP	TQFN-EP		
1	19	14	READY	Ready to Transmit Output, Active-High. READY is enabled high when V- goes below -4V and the device is ready to transmit.
2	1	16	C1+	Positive Terminal of the Voltage Doubler Charge-Pump Capacitor
3	20	15	V+	+5.5V Generated by the Charge Pump
4	2	1	C1-	Negative Terminal of the Voltage Doubler Charge-Pump Capacitor
5	3	2	C2+	Positive Terminal of the Inverting Charge-Pump Capacitor
6	4	3	C2-	Negative Terminal of the Inverting Charge-Pump Capacitor
7	5	4	V-	-5.5V Generated by the Charge Pump
8	6	—	T2OUT	RS-232 Transmitter Output 2
—	—	5	RIN	RS-232 Receiver Input
9	7	—	R2IN	RS-232 Receiver Input 2
—	—	6	ROUT	CMOS Receiver Output. $V_L$ referred logic.
10	8	—	R2OUT	CMOS Receiver Output 2. $V_L$ referred logic.
11	9	7	$V_L$	Logic-Level Supply. All CMOS inputs and outputs are related to this supply.
—	—	8	TIN	CMOS Transmitter Input. $V_L$ referred logic.
12	10	—	T2IN	CMOS Transmitter Input 2. $V_L$ referred logic.
13	11	—	T1IN	CMOS Transmitter Input 1. $V_L$ referred logic.
14	12	9	FORCEON	FORCEON Input, Active-High. $V_L$ referenced logic. Drive FORCEON high to override automatic circuitry keeping transmitters on ( $\overline{\text{FORCEOFF}}$ must be high). See Table 1.
15	13	—	R1OUT	CMOS Receiver Output 1. $V_L$ referred logic.
—	—	10	TOUT	RS-232 Transmitter Output
16	14	—	R1IN	RS-232 Receiver Input 1
17	15	—	T1OUT	RS-232 Transmitter Output 1
18	16	11	GND	Ground
19	17	12	VCC	+3V to +5.5V Supply Voltage
20	18	13	$\overline{\text{FORCEOFF}}$	$\overline{\text{FORCEOFF}}$ Input, Active-Low. $V_L$ referenced logic. Drive $\overline{\text{FORCEOFF}}$ low to shut down transmitters and on-board charge pumps. All receiver and transmitter outputs are tri-stated. This overrides all automatic circuitry and FORCEON (Table 1).
—	—	—	EP	Exposed Pad. Connect EP to GND or leave unconnected.

## Detailed Description

### VL Logic Supply Input

The MAX13234E–MAX13237E feature a separate logic supply input ( $V_L$ ) that sets the receiver's output level ( $V_{OH}$ ), and sets the transmitter's input thresholds ( $V_{IL}$ ,  $V_{IH}$ ). This feature allows flexibility in interfacing to UARTs or communication controllers that have different logic levels. Connect this input to the host logic supply ( $1.62V \leq V_L \leq V_{CC}$ ).

### Dual Charge-Pump Voltage Converter

The internal power supply consists of a regulated dual charge pump that provides output voltages of +5.5V and -5.5V (inverting charge pump), over the +3.0V to +5.5V range. The charge pump operates in discontinuous mode: if the output voltages are less than +5.5V, the charge pump is enabled; if the output voltages exceed +5.5V, the charge-pump is disabled. The charge pumps require flying capacitors (C1, C2) and reservoir capacitors (C3, C4) to generate the  $V_+$  and  $V_-$  supplies. The READY output is low when the charge pumps are disabled in shutdown mode. The READY signal asserts high when  $V_-$  goes below -4V.

### RS-232 Transmitters

The transmitters are inverting level translators that convert CMOS-logic levels to ±5.0V EIA/TIA-232 levels. The MAX13234E/MAX13236E guarantee a 250kbps data rate with worst-case loads of 3kΩ in parallel with 1000pF. The MAX13235E/MAX13237E guarantee a 1Mbps data rate with worst-case loads of 3kΩ in parallel with 150pF. Transmitters can be paralleled to drive multiple receivers. When FORCEOFF is driven to ground or when the AutoShutdown Plus circuitry senses that all receiver and transmitter inputs are inactive for more than 30s, the transmitters are disabled and the outputs go into a high-impedance state. When powered off or shut down, the outputs can be driven to ±12V. The transmitter inputs do not have pullup resistors. Connect unused inputs to GND or  $V_L$ .

### RS-232 Receivers

The receivers convert RS-232 signals to CMOS-logic output levels. The MAX13234E–MAX13237E have inverting outputs that are active when in shutdown (FORCEOFF = GND) (Table 1).

### AutoShutdown Plus Mode

Drive FORCEOFF high and FORCEON low to invoke AutoShutdown Plus mode. When these devices do not sense a valid signal transition on any receiver and transmitter input for 30s, the onboard charge pumps are shut down, reducing supply current to 1μA. This occurs if the RS-232 cable is disconnected or if the devices driving the transmitter and receiver inputs are inactive for more than 30s. The MAX13234E–MAX13237E turn on again when a valid transition is applied to any RS-232 receiver or transmitter input. As a result, the system saves power without requiring any control.

Figure 6 and Table 1 summarize the MAX13234E–MAX13237E operating modes. The FORCEON and FORCEOFF inputs override AutoShutdown Plus circuitry. When neither control is asserted, the IC selects between these states automatically based on the last receiver or transmitter input edge received.

### Hardware-Controlled Shutdown

Drive FORCEOFF low to place the MAX13234E–MAX13237E into shutdown mode.

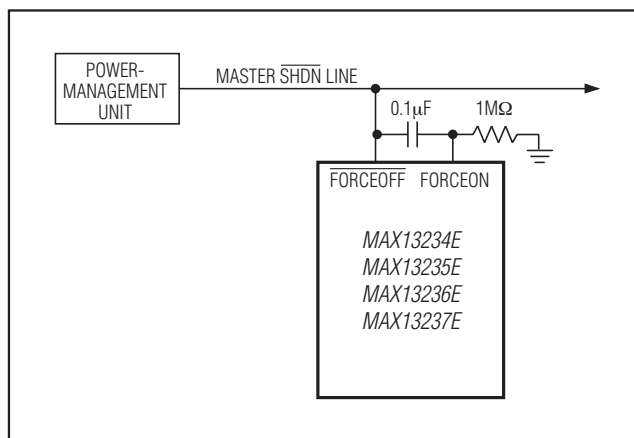

Figure 7. AutoShutdown Plus Initial Turn-On to Wake Up a Mouse or Another System



Figure 6. AutoShutdown Plus and Shutdown Logic

**Table 1. Transceiver Mode Control**

$\overline{\text{FORCEOFF}}$	FORCEON	R_IN or T_IN EDGE WITHIN 30s	T_OUT	R_OUT	TRANSCEIVER STATUS
0	X	X	High-Impedance	Active	Shutdown (Forced Off)
1	1	X	Active	Active	Normal Operation (Forced On)
1	0	Yes	Active	Active	Normal Operation in AutoShutdown Plus
1	0	No	High-Impedance	Active	Shutdown in AutoShutdown Plus

X = Don't Care.

# MAX13234E–MAX13237E

# 3Mbps RS-232 Transceivers with Low-Voltage Interface, $\pm 15\text{kV}$ HBM ESD

## $\pm 15\text{kV}$ ESD Protection

ESD-protection structures are incorporated on all pins to protect against electrostatic discharges encountered during handling and assembly. The driver outputs and receiver inputs of the MAX13234E–MAX13237E have extra protection against static electricity. Maxim's engineers have developed state-of-the-art structures to protect these pins against ESD of  $\pm 15\text{kV}$  without damage. The ESD structures withstand high ESD in all states: normal operation, shutdown, and powered down. After

an ESD event, Maxim's E versions keep working without latchup. ESD protection can be tested in various ways; the transmitter outputs and receiver inputs of this product family are characterized for protection to the following limits:

- 1)  $\pm 15\text{V}$  Using the Human Body Model
- 2)  $\pm 15\text{kV}$  Using IEC 61000-4-2 Air-Gap Method
- 3)  $\pm 8\text{kV}$  Using IEC 61000-4-2 Contact-Discharge Method



Figure 8a. Human Body ESD Test Model



Figure 9a. IEC61000-4-2 ESD Test Model



Figure 8b. Human Body Current Waveform



Figure 9b. IEC61000-4-2 ESD Generator Current Waveform

# MAX13234E–MAX13237E

## 3Mbps RS-232 Transceivers with Low-Voltage Interface, $\pm 15\text{kV}$ HBM ESD

### ESD Test Conditions

ESD performance depends on a variety of conditions. Contact Maxim for a reliability report that documents test setup, test methodology, and test results.

### Human Body Model

Figure 8a shows the Human Body Model and Figure 8b shows the current waveform it generates when discharged into a low impedance. This model consists of a 100pF capacitor charged to the ESD voltage of interest, which is then discharged into the test device through a 1.5k $\Omega$  resistor.

### IEC 61000-4-2

The IEC 61000-4-2 standard covers ESD testing and performance of finished equipment; it does not specifically refer to integrated circuits. The MAX13234E–MAX13237E helps design equipment that meets Level 4 (the highest level) of IEC 61000-4-2, without the need for additional ESD-protection components. The major difference between tests done using the Human Body Model and IEC 61000-4-2 is higher peak current in IEC 61000-4-2, because series resistance is lower in the IEC 61000-4-2 model. Hence, the ESD withstand voltage measured to IEC 61000-4-2 is generally lower than that measured using the Human Body Model. Figure 9a shows the IEC 61000-4-2 model and Figure 9b shows the current waveform for the 8kV, IEC 61000-4-2, Level 4, ESD Contact-Discharge Method.

The Air-Gap Method involves approaching the device with a charged probe. The Contact-Discharge Method connects the probe to the device before the probe is energized.

## Applications Information

### Capacitor Selection

The capacitor type used for C1–C4 is not critical for proper operation; polarized or non-polarized capacitors can be used. The charge pump requires 0.1 $\mu\text{F}$  capacitors for  $V_{CC} = +3.3\text{V}$  operation. For other supply voltages, see Table 2 for required capacitor values. Do not use values smaller than those listed in Table 2. Increasing the capacitor values (e.g., by a factor of 2) reduces ripple on the transmitter outputs and slightly reduces power consumption. C2, C3, and C4 can be increased without changing C1's value. **However, do not increase C1 without also increasing the values of C2, C3, C4, CBYPASS1, and CBYPASS2 to maintain the proper ratios (C1 to the other capacitors).** When using the minimum required capacitor values, make sure the capacitor value does not degrade excessively with temperature. If in doubt, use capacitors with a

larger nominal value. The capacitor's equivalent series resistance (ESR), usually rises at low temperatures influencing the amount of ripple on  $V_+$  and  $V_-$ .

**Table 2. Required Minimum Capacitance Values**

$V_{CC}$ (V)	C1, CBYPASS2 ( $\mu\text{F}$ )	CBYPASS1 ( $\mu\text{F}$ )	C2, C3, C4 ( $\mu\text{F}$ )
3.0 to 3.6	0.22	0.22	0.22
3.15 to 3.6	0.1	0.1	0.1
4.5 to 5.5	0.047	1	0.33
3.0 to 5.5	0.22	1	1

### Power-Supply Decoupling

In most circumstances, a 0.1 $\mu\text{F}$   $V_{CC}$  bypass capacitor and a 1 $\mu\text{F}$   $V_L$  bypass capacitor are adequate. In applications that are sensitive to power-supply noise, use capacitors of the same value as charge-pump capacitor C1. Connect bypass capacitors as close to the IC as possible.

### Transmitter Outputs when Exiting Shutdown

Figure 10 shows two transmitter outputs when exiting shutdown mode. As they become active, the two transmitter outputs are shown going to opposite RS-232 levels (one transmitter input is high, the other is low). Each transmitter is loaded with 3k $\Omega$  in parallel with 1000pF. The transmitter outputs display no ringing or undesirable transients as they come out of shutdown. Note that the transmitters are enabled only when the magnitude of  $V_-$  exceeds approximately -3V.

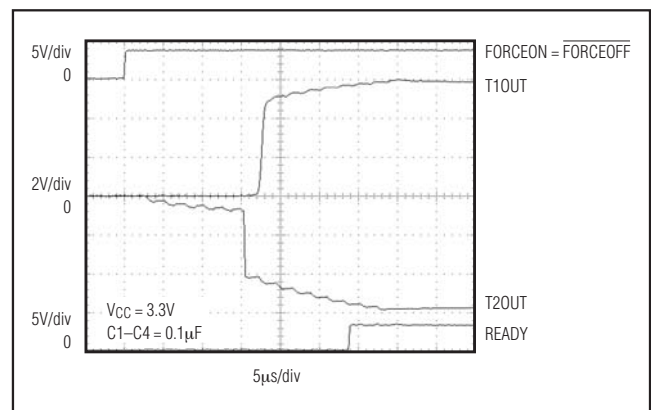

Figure 10. Transmitter Outputs when Exiting Shutdown or Powering Up

# MAX13234E–MAX13237E

## 3Mbps RS-232 Transceivers with Low-Voltage Interface, $\pm 15\text{kV}$ HBM ESD

### High Data Rates

The MAX13234E–MAX13237E maintain the RS-232  $\pm 5\text{V}$  minimum transmitter output voltage even at high data rates. Figure 11 shows a transmitter loopback test circuit. Figure 12 shows a loopback test result at 120kbps, and Figure 13 shows the same test at 3Mbps.



Figure 11. Loopback Test Circuit

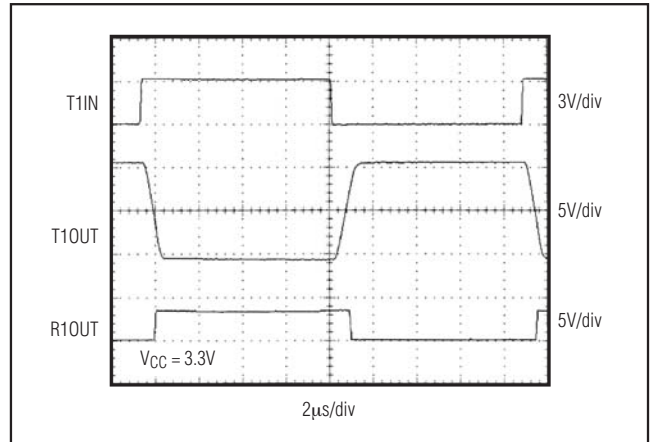

Figure 12. Loopback Test Results at 120kbps

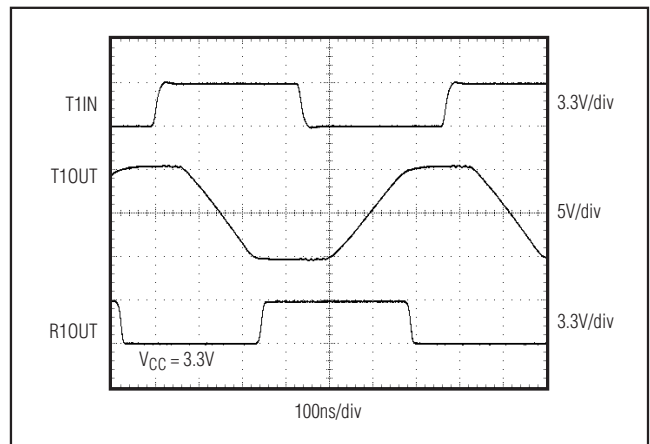

Figure 13. Loopback Test Results at 3Mbps

### Chip Information

PROCESS: BiCMOS

# MAX13234E–MAX13237E

3Mbps RS-232 Transceivers with  
Low-Voltage Interface,  $\pm 15kV$   
HBM ESD

## Pin Configurations

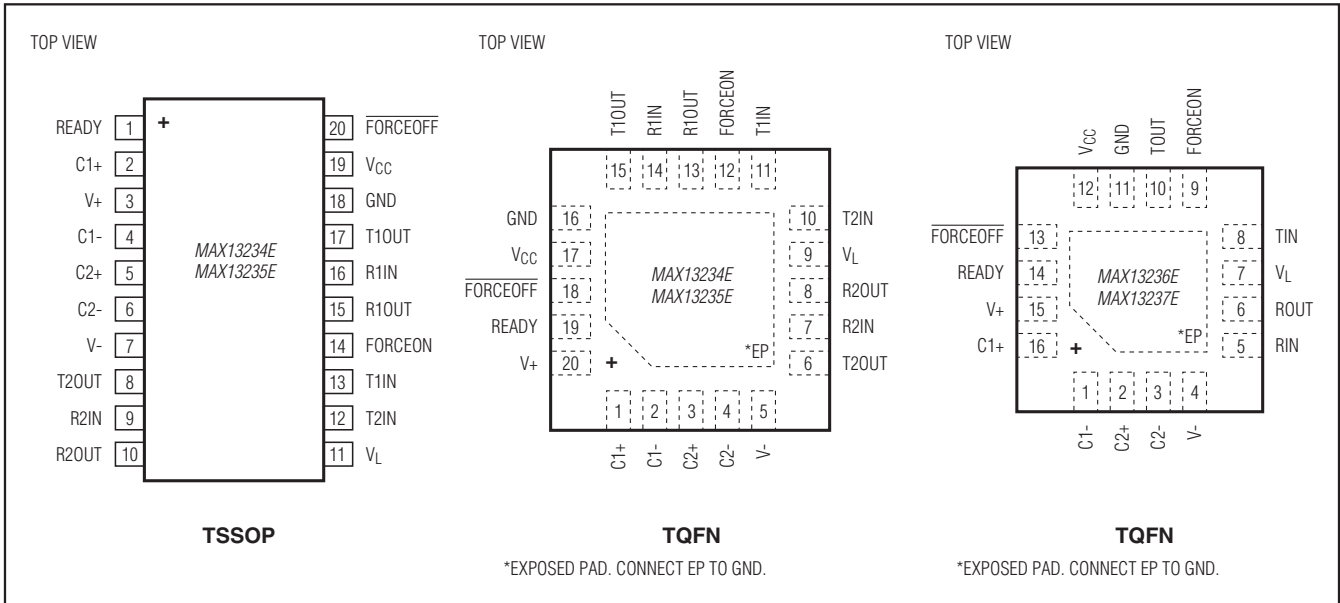

## Functional Diagrams (continued)

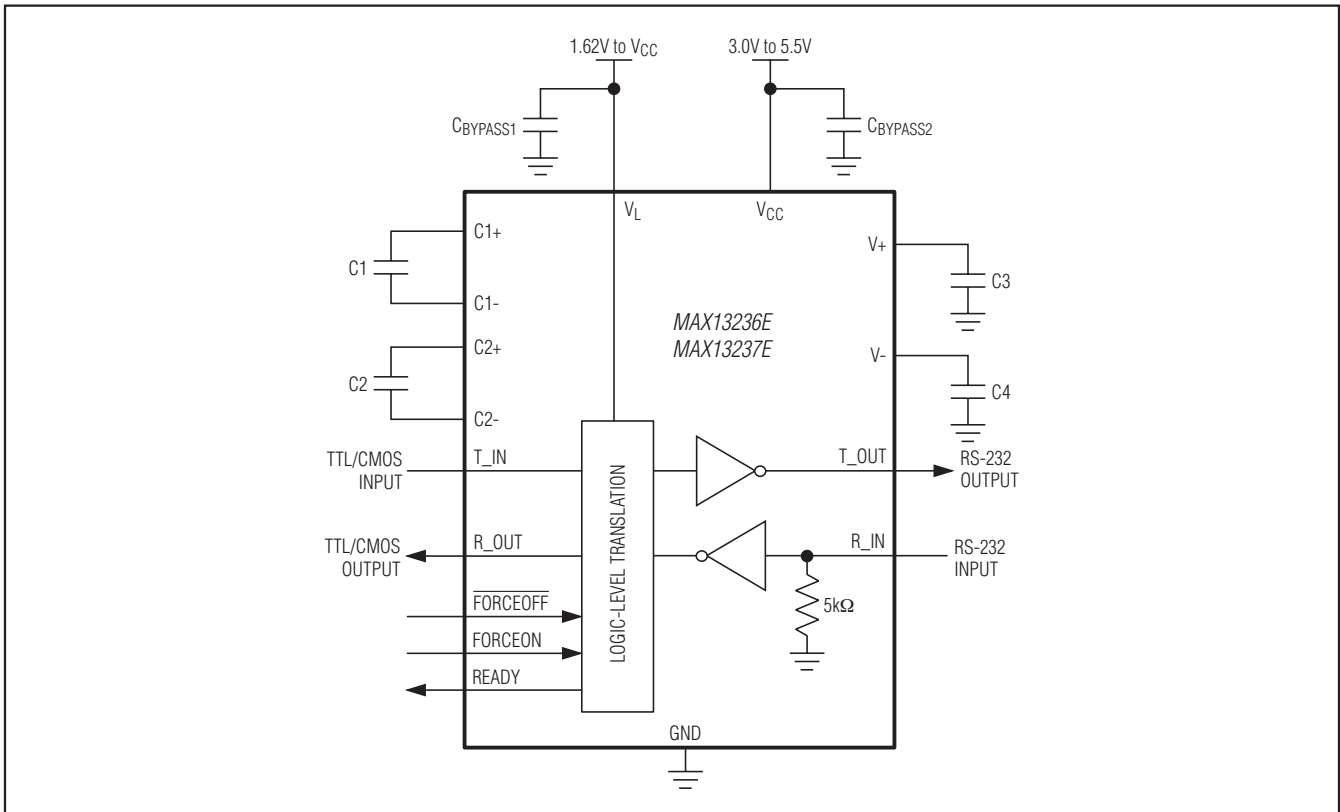

## Package Information

For the latest package outline information and land patterns (footprints), go to [www.maximintegrated.com/packages](http://www.maximintegrated.com/packages). Note that a "+", "#", or "-" in the package code indicates RoHS status only. Package drawings may show a different suffix character, but the drawing pertains to the package regardless of RoHS status.

PACKAGE TYPE	PACKAGE CODE	DOCUMENT NO.
20 TSSOP	U20-2	<a href="#">21-0066</a>
20 TQFN-EP*	T2055-5	<a href="#">21-0140</a>
16 TQFN-EP*	T1655-2	<a href="#">21-0140</a>

\*EP = Exposed Pad.



## Revision History

REVISION NUMBER	REVISION DATE	DESCRIPTION	PAGES CHANGED
0	10/08	Initial release	—
1	12/14	Updated <i>General Description</i> and <i>Benefits and Features</i> sections	1

For pricing, delivery, and ordering information, please contact Maxim Direct at 1-888-629-4642, or visit Maxim Integrated's website at [www.maximintegrated.com](http://www.maximintegrated.com).

*Maxim Integrated cannot assume responsibility for use of any circuitry other than circuitry entirely embodied in a Maxim Integrated product. No circuit patent licenses are implied. Maxim Integrated reserves the right to change the circuitry and specifications without notice at any time. The parametric values (min and max limits) shown in the Electrical Characteristics table are guaranteed. Other parametric values quoted in this data sheet are provided for guidance.*



Компания «ЭлектроПласт» предлагает заключение долгосрочных отношений при поставках импортных электронных компонентов на взаимовыгодных условиях!

Наши преимущества:

- Оперативные поставки широкого спектра электронных компонентов отечественного и импортного производства напрямую от производителей и с крупнейших мировых складов;
- Поставка более 17-ти миллионов наименований электронных компонентов;
- Поставка сложных, дефицитных, либо снятых с производства позиций;
- Оперативные сроки поставки под заказ (от 5 рабочих дней);
- Экспресс доставка в любую точку России;
- Техническая поддержка проекта, помощь в подборе аналогов, поставка прототипов;
- Система менеджмента качества сертифицирована по Международному стандарту ISO 9001;
- Лицензия ФСБ на осуществление работ с использованием сведений, составляющих государственную тайну;
- Поставка специализированных компонентов (Xilinx, Altera, Analog Devices, Intersil, Interpoint, Microsemi, Aeroflex, Peregrine, Syfer, Eurofarad, Texas Instrument, Miteq, Cobham, E2V, MA-COM, Hittite, Mini-Circuits, General Dynamics и др.);

Помимо этого, одним из направлений компании «ЭлектроПласт» является направление «Источники питания». Мы предлагаем Вам помощь Конструкторского отдела:

- Подбор оптимального решения, техническое обоснование при выборе компонента;
- Подбор аналогов;
- Консультации по применению компонента;
- Поставка образцов и прототипов;
- Техническая поддержка проекта;
- Защита от снятия компонента с производства.



#### Как с нами связаться

**Телефон:** 8 (812) 309 58 32 (многоканальный)

**Факс:** 8 (812) 320-02-42

**Электронная почта:** [org@eplast1.ru](mailto:org@eplast1.ru)

**Адрес:** 198099, г. Санкт-Петербург, ул. Калинина, дом 2, корпус 4, литера А.