

## HEIDI-RS

~8° spot beam

### TECHNICAL SPECIFICATIONS:

Dimensions	Ø 21.6 mm
Height	11.7 mm
Fastening	tape, pin
ROHS compliant	yes 

### MATERIAL SPECIFICATIONS:

Component	Type	Material	Colour	Finish
HEIDI-RS	Single lens	PMMA	clear	
HEIDI-TAPE	Tape	PU tape	black	



### ORDERING INFORMATION:

Component		Qty in box	MOQ	MPQ	Box weight (kg)
CA12537_HEIDI-RS	Single lens	3264	204	204	11.1
» Box size: 480 x 280 x 300 mm					

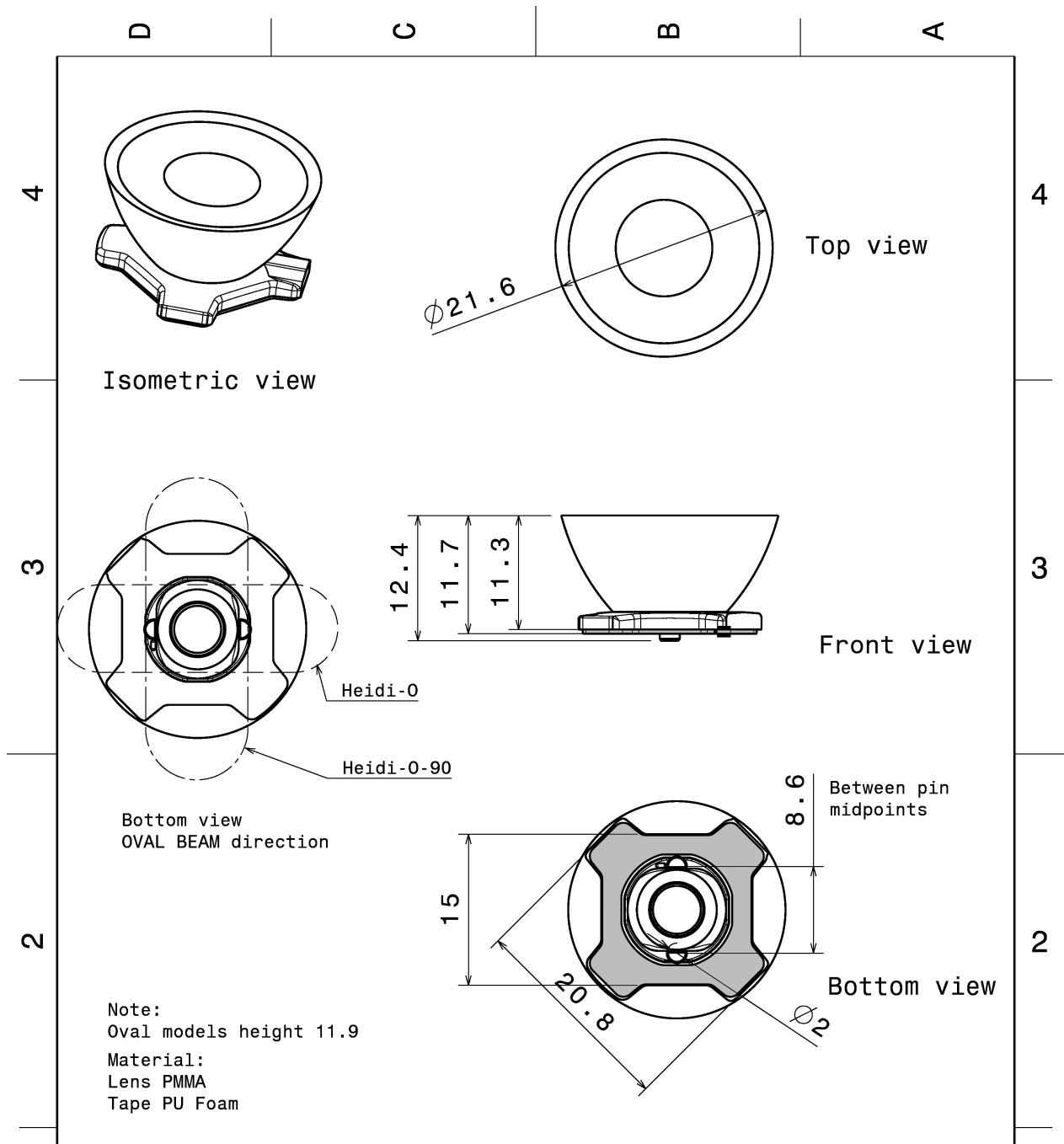

This drawing is our property. It can't be reproduced or communicated without our written agreement.		<b>LEDiL</b>		Ledil Oy Joensuunkatu 13 FIN-24100 SALO Finland	
DRAWING TITLE		<b>Datasheet Heidi-Series Assy</b>			
DRAWN BY ah	DATE 1.2.2012	SIZE A4	DRAWING NUMBER		REV 2
CHECKED BY	DATE	SCALE 2:1	WEIGHT (g)	SHEET 1/1	
DESIGNED BY	DATE				

#### PHOTOMETRIC DATA (MEASURED):

#### CREE

LED XP-G2  
 FWHM 10.0°  
 Efficiency 94 %  
 Peak intensity 20 cd/lm  
 LEDs/each optic 1  
 Light colour White  
 Required components:

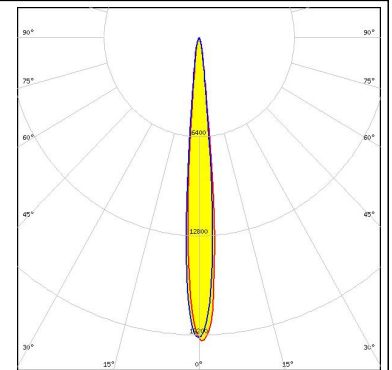

#### CREE

LED XP-G3  
 FWHM 12.0°  
 Efficiency 94 %  
 Peak intensity 13 cd/lm  
 LEDs/each optic 1  
 Light colour White  
 Required components:

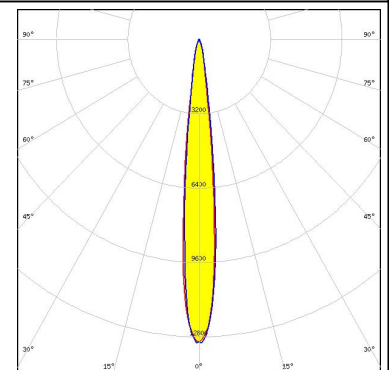

#### CREE

LED XP-L HD  
 FWHM 15.0°  
 Efficiency 89 %  
 Peak intensity 8.3 cd/lm  
 LEDs/each optic 1  
 Light colour White  
 Required components:

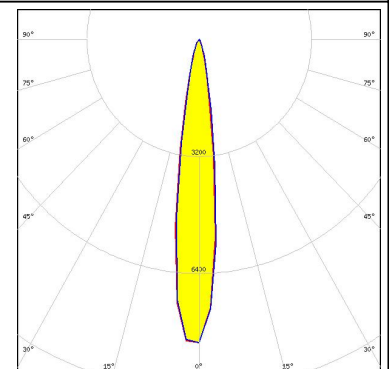
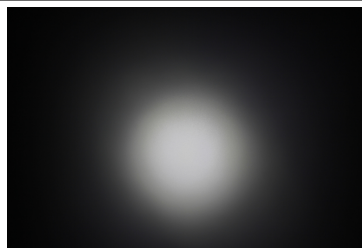

#### LUMILEDS

LED LUXEON A  
 FWHM 11.0°  
 Efficiency 87 %  
 Peak intensity 15.6 cd/lm  
 LEDs/each optic 1  
 Light colour White  
 Required components:

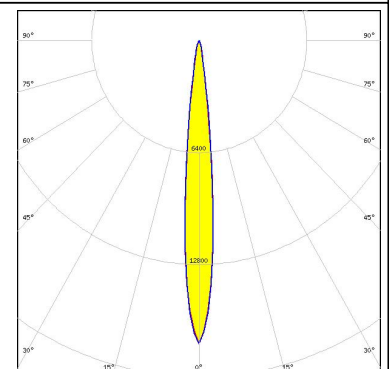

#### PHOTOMETRIC DATA (MEASURED):

##### LUMILEDS

LED LUXEON Rebel  
 FWHM 8.0°  
 Efficiency 88 %  
 Peak intensity 26 cd/Im  
 LEDs/each optic 1  
 Light colour White  
 Required components:

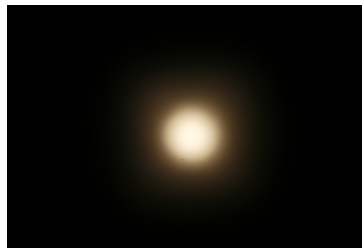

##### LUMILEDS

LED LUXEON Rebel ES  
 FWHM 11.0°  
 Efficiency 86 %  
 Peak intensity 15.1 cd/Im  
 LEDs/each optic 1  
 Light colour White  
 Required components:



##### LUMINUS

LED SST-10-B130  
 FWHM 8.0°  
 Efficiency 96 %  
 Peak intensity 27.9 cd/Im  
 LEDs/each optic 1  
 Light colour Blue  
 Required components:

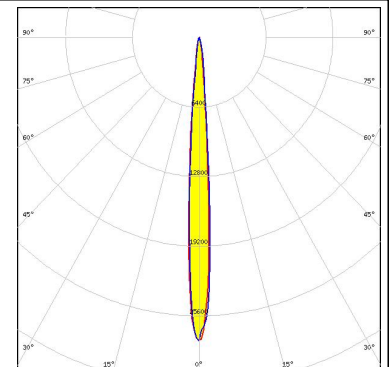
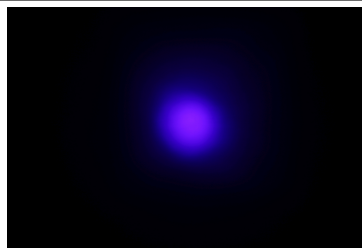





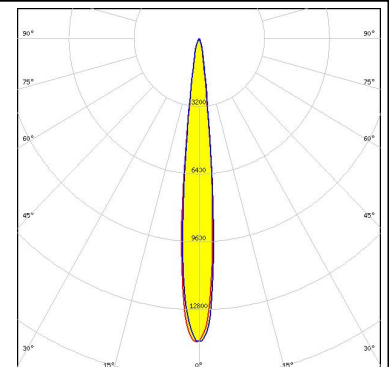

##### NICHIA

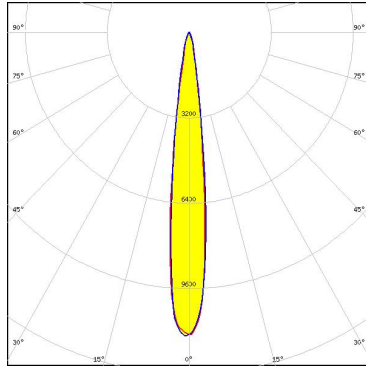

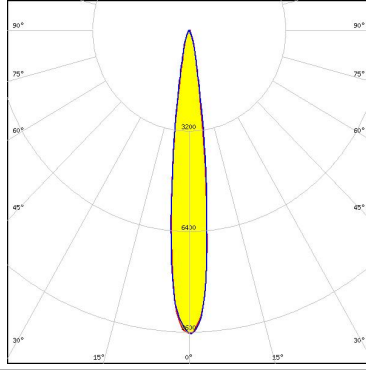
LED NVSW219D  
 FWHM 11.0°  
 Efficiency 94 %  
 Peak intensity 14.3 cd/Im  
 LEDs/each optic 1  
 Light colour White  
 Required components:

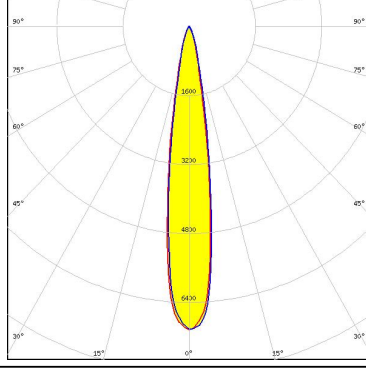

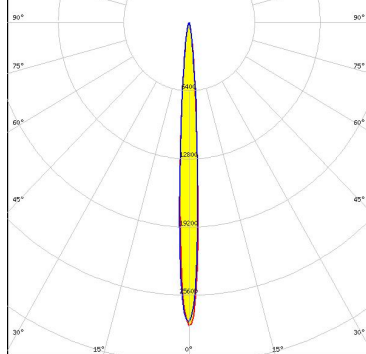
### PHOTOMETRIC DATA (MEASURED):

<p><b>NICHIA</b></p> <p>LED NVSW319B            FWHM 13.0°            Efficiency 94 %            Peak intensity 11.4 cd/lm            LEDs/each optic 1            Light colour White            Required components:</p>		
<p><b>NICHIA</b></p> <p>LED NVSW3x9A            FWHM 13.0°            Efficiency 92 %            Peak intensity 9.7 cd/lm            LEDs/each optic 1            Light colour White            Required components:</p>		
<p><b>NICHIA</b></p> <p>LED NWSx229A            FWHM 16.0°            Efficiency 87 %            Peak intensity 7 cd/lm            LEDs/each optic 1            Light colour White            Required components:</p>		
<p><b>OSRAM</b>  <small>Opto Semiconductors</small></p> <p>LED OSLOM SSL 150            FWHM 7.0°            Efficiency 89 %            Peak intensity 28.5 cd/lm            LEDs/each optic 1            Light colour White            Required components:</p>		

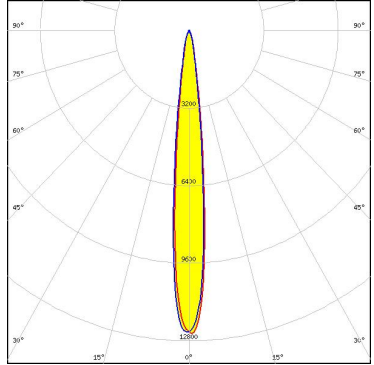
**PHOTOMETRIC DATA (MEASURED):**

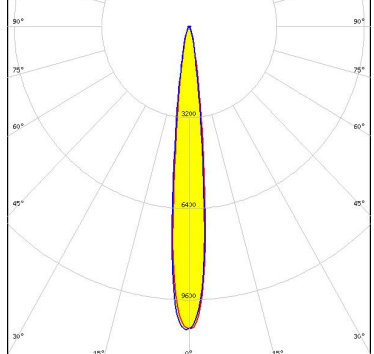
<p><b>OSRAM</b> Opto Semiconductors</p> <p>LED PLPVEC2 850A FWHM 6.0° Efficiency % LEDs/each optic 1 Light colour IR Required components:</p>	
<p><b>SEOL</b> SEOUL SEMICONDUCTOR</p> <p>LED Z5M3 FWHM 11.0° Efficiency 94 % Peak intensity 12.5 cd/lm LEDs/each optic 1 Light colour White Required components:</p>	 
<p><b>SEOL</b> SEOUL SEMICONDUCTOR</p> <p>LED Z8Y22P FWHM 12.0° Efficiency 94 % Peak intensity 10.7 cd/lm LEDs/each optic 1 Light colour White Required components:</p>	 

### PHOTOMETRIC DATA (SIMULATED):



LED XP-G2 HE  
 FWHM 12.0°  
 Efficiency 95 %  
 Peak intensity 12 cd/lm  
 LEDs/each optic 1  
 Light colour White  
 Required components:

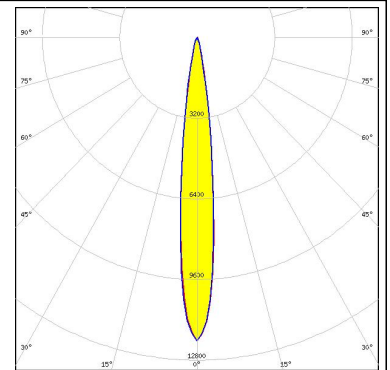

LED LUXEON IR Domed 150  
 FWHM 11.0°  
 Efficiency 94 %  
 LEDs/each optic 1  
 Light colour White  
 Required components:



LED LUXEON IR Domed 90  
 FWHM 11.0°  
 Efficiency 94 %  
 LEDs/each optic 1  
 Light colour White  
 Required components:



LED LUXEON R  
 FWHM 11.0°  
 Efficiency 92 %  
 Peak intensity 16.5 cd/lm  
 LEDs/each optic 1  
 Light colour White  
 Required components:

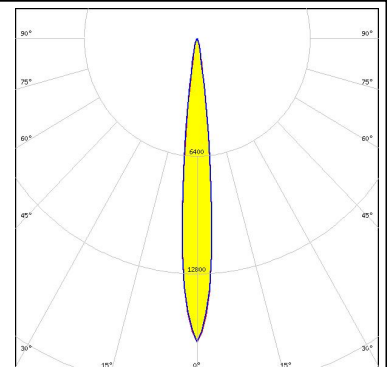

### PHOTOMETRIC DATA (SIMULATED):

<p><b>LUMILEDS</b></p> <p>LED LUXEON SunPlus 20 Line (120 deg)            FWHM 8.0°            Efficiency 96 %            Peak intensity 30.1 cd/lm            LEDs/each optic 1            Light colour White            Required components:</p>	
<p><b>LUMILEDS</b></p> <p>LED LUXEON SunPlus 20 Line (150 deg)            FWHM 7.8°            Efficiency 93 %            Peak intensity 29.8 cd/lm            LEDs/each optic 1            Light colour White            Required components:</p>	
<p><b>LUMILEDS</b></p> <p>LED LUXEON SunPlus 20 Line (150 deg)            FWHM 8.0°            Efficiency 92 %            Peak intensity 28.9 cd/lm            LEDs/each optic 1            Light colour White            Required components:</p>	
<p><b>LUMILEDS</b></p> <p>LED LUXEON SunPlus 35 Line            FWHM 7.8°            Efficiency 94 %            Peak intensity 31.4 cd/lm            LEDs/each optic 1            Light colour White            Required components:</p>	

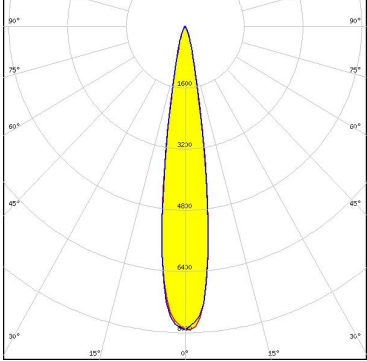
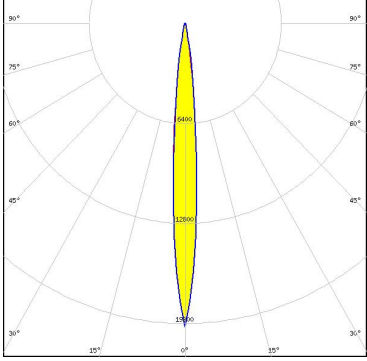
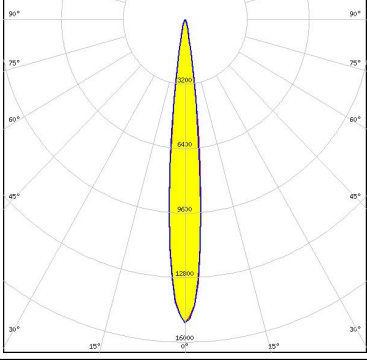
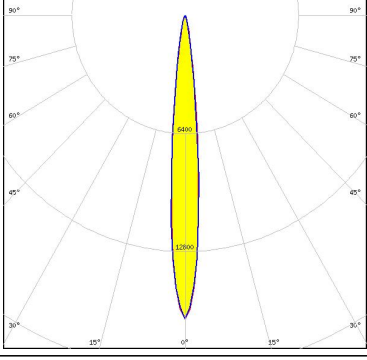

### PHOTOMETRIC DATA (SIMULATED):

<p><b>NICHIA</b></p> <p>LED NV4WB35AM            FWHM 16.0°            Efficiency 96 %            Peak intensity 8 cd/lm            LEDs/each optic 1            Light colour White            Required components:</p>	
<p><b>NICHIA</b></p> <p>LED NVSxE21A            FWHM 10.0°            Efficiency 94 %            Peak intensity 19.4 cd/lm            LEDs/each optic 1            Light colour White            Required components:</p>	
<p><b>NICHIA</b></p> <p>LED NVSxx19B/NVSxx19C            FWHM 12.0°            Efficiency 95 %            Peak intensity 15 cd/lm            LEDs/each optic 1            Light colour White            Required components:</p>	
<p><b>OSRAM</b>  <small>Opto Semiconductors</small></p> <p>LED OSCONIQ P 3737 Flat            FWHM 10.0°            Efficiency 96 %            Peak intensity 16.5 cd/lm            LEDs/each optic 1            Light colour White            Required components:</p>	

#### PHOTOMETRIC DATA (SIMULATED):

#### OSRAM

Opto Semiconductors

LED OSLOM Black  
 FWHM 11.0°  
 Efficiency 93 %  
 Peak intensity 16.8 cd/lm  
 LEDs/each optic 1  
 Light colour White  
 Required components:

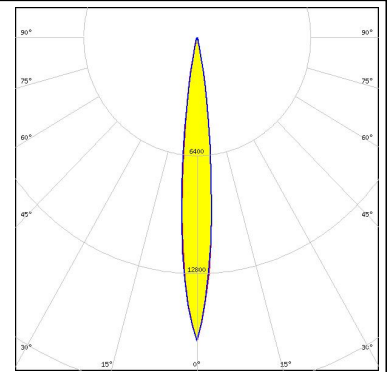

#### OSRAM

Opto Semiconductors

LED OSLOM Black Flat  
 FWHM 7.3°  
 Efficiency 94 %  
 Peak intensity 38.3 cd/lm  
 LEDs/each optic 1  
 Light colour White  
 Required components:

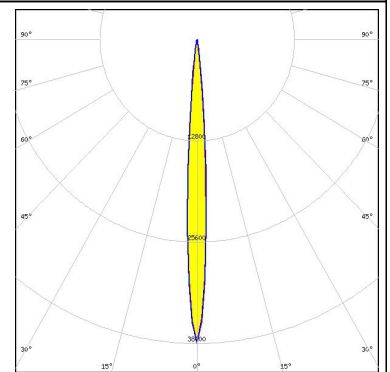

#### SAMSUNG

LED LH351D  
 FWHM 16.0°  
 Efficiency 94 %  
 Peak intensity 8.2 cd/lm  
 LEDs/each optic 1  
 Light colour White  
 Required components:

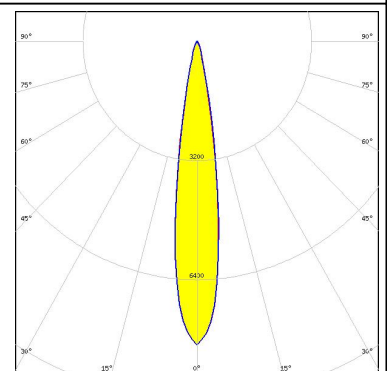

### GENERAL INFORMATION:

NOTE: The typical beam angle will be changed by different color, chip size and chip position tolerance. The typical total beam angle is the full angle measured where the luminous intensity is half of the peak value.

### MATERIALS:

As part of our continuous research and improvement processes, and to ensure the best possible quality and availability of our products, LEDiL reserves the right to change material grades without notice.

### PRODUCT DATA USER AGREEMENT AND DISCLAIMER:

The measured data in the provided downloadable LEDiL Product Datasheets and Mechanical 2D-Drawings is rounded and provided as reference for planning. LEDiL Oy's optical specifications have been verified by conducting performance testing of the products in accordance with the company's quality system. The reported data are averaged results of multiple measurements with typical variation. LEDiL Oy reserves the right to without prior notification make changes and improvements to its products.

LEDiL Oy assumes neither warranty, nor guarantee nor any other liability of any kind for the contents and correctness of the provided data. The provided data has been generated with highest diligence but the provided data may in reality not represent the complete possible variation range of all intrinsic parameters. Therefore, in certain cases a deviation from the provided data could occur.

LEDiL Oy reserves the right to undertake technical changes of its products without further notification which could lead to changes in the provided data. LEDiL Oy assumes no liability of any kind for the possible deviation from any provided data or any other damage resulting from the usage of the provided data.

The user agrees to this disclaimer and user agreement with the download or usage of the provided files.

#### LEDiL Oy

Joensuunkatu 13  
FI-24240 SALO  
Finland

#### LEDiL Inc.

228 West Page Street  
Suite D  
Sycamore IL 60178  
USA

#### Local sales and technical support

[www.ledil.com/  
where\\_to\\_buy](http://www.ledil.com/where_to_buy)

#### Shipping locations

Salo, Finland  
Hong Kong, China

#### Distribution Partners

[www.ledil.com/  
where\\_to\\_buy](http://www.ledil.com/where_to_buy)



Компания «ЭлектроПласт» предлагает заключение долгосрочных отношений при поставках импортных электронных компонентов на взаимовыгодных условиях!

Наши преимущества:

- Оперативные поставки широкого спектра электронных компонентов отечественного и импортного производства напрямую от производителей и с крупнейших мировых складов;
- Поставка более 17-ти миллионов наименований электронных компонентов;
- Поставка сложных, дефицитных, либо снятых с производства позиций;
- Оперативные сроки поставки под заказ (от 5 рабочих дней);
- Экспресс доставка в любую точку России;
- Техническая поддержка проекта, помощь в подборе аналогов, поставка прототипов;
- Система менеджмента качества сертифицирована по Международному стандарту ISO 9001;
- Лицензия ФСБ на осуществление работ с использованием сведений, составляющих государственную тайну;
- Поставка специализированных компонентов (Xilinx, Altera, Analog Devices, Intersil, Interpoint, Microsemi, Aeroflex, Peregrine, Syfer, Eurofarad, Texas Instrument, Miteq, Cobham, E2V, MA-COM, Hittite, Mini-Circuits, General Dynamics и др.);

Помимо этого, одним из направлений компании «ЭлектроПласт» является направление «Источники питания». Мы предлагаем Вам помощь Конструкторского отдела:

- Подбор оптимального решения, техническое обоснование при выборе компонента;
- Подбор аналогов;
- Консультации по применению компонента;
- Поставка образцов и прототипов;
- Техническая поддержка проекта;
- Защита от снятия компонента с производства.



#### Как с нами связаться

**Телефон:** 8 (812) 309 58 32 (многоканальный)

**Факс:** 8 (812) 320-02-42

**Электронная почта:** [org@eplast1.ru](mailto:org@eplast1.ru)

**Адрес:** 198099, г. Санкт-Петербург, ул. Калинина, дом 2, корпус 4, литера А.