

PKB 4000 series  
DC/DC converters, Input 36-75 V, Output 30 A/90 W

EN/LZT 146 394 R6A November 2017

© Flex

### Key Features

- Industry standard Eighth-brick  
58.4 x 22.7 x 8.10 mm (2.30 x 0.894 x 0.32 in.)
- Low profile, max 8.10 mm (0.32 in.)
- High efficiency, typ. 90.6 % at half load
- 2250 Vdc input to output isolation
- Meets isolation requirements equivalent to basic insulation according to IEC/EN/UL 60950
- More than 4.7 million hours predicted MTBF at +40°C ambient temperature

### General Characteristics

- Suited for narrow board pitch applications (15 mm/0.6 in)
- Output over voltage protection
- Input under voltage shutdown
- Over temperature protection
- Output short-circuit protection
- Remote sense
- Remote control
- Output voltage adjust function
- Highly automated manufacturing ensures quality
- ISO 9001/14001 certified supplier

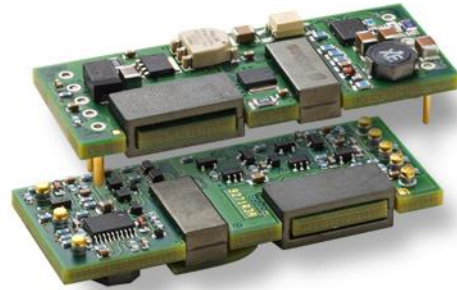

#### Safety Approvals



#### Design for Environment



Meets requirements in high-temperature lead-free soldering processes.

### Contents

General Information	2
Safety Specification	3
Absolute Maximum Ratings	4
Product Program	Ordering No.
1.0V, 30A / 30W Electrical Specification	PKB 4318N PINB..... 5
1.2V, 30A / 36W Electrical Specification	PKB 4318 PIOBNB ..... 8
1.5V, 30A / 45W Electrical Specification	PKB 4418 PIOANB ..... 11
1.8V, 25A / 45W Electrical Specification	PKB 4418 PINB ..... 14
2.5V, 25A / 62.5W Electrical Specification	PKB 4619 PINB ..... 17
3.3V, 20A / 66W Electrical Specification	PKB 4610 PINB ..... 20
3.3V, 25A / 82.5W Electrical Specification	PKB 4810 PINB ..... 23
5.0V, 15A / 75W Electrical Specification	PKB 4711 PINB ..... 26
12V, 6A / 72W Electrical Specification	PKB 4713 PINB ..... 29
12V, 7.5A / 90W Electrical Specification	PKB 4913 PINB ..... 32
15V, 5A / 75W Electrical Specification	PKB 4715 PINB ..... 35
EMC Specification	38
Operating Information	39
Thermal Consideration	40
Connections	41
Mechanical Information	42
Soldering Information	44
Delivery Information	45
Product Qualification Specification	46

PKB 4000 series  
DC/DC converters, Input 36-75 V, Output 30 A/90 W

EN/LZT 146 394 R6A November 2017

© Flex

## General Information

### Ordering Information

See Contents for individual product ordering numbers.

Option	Suffix	Ordering No.
Isolated Surface mount	SI	PKB 4711 SINB
Positive Remote Control Logic	P	PKB 4711 PIPNB
Increased stand-off height	M	PKB 4711 PINBM
Lead length 3.69 mm (0.145 in)	LA	PKB 4711 PINBLA
Lead length 4.57 mm (0.180 in)	LB	PKB 4711 PINBLB

Note : As an example a positive logic, increased standoff, short pin product would be PKB 4711 PIPNBMLA.

### Reliability

The failure rate ( $\lambda$ ) and mean time between failures (MTBF= $1/\lambda$ ) is calculated at max output power and an operating ambient temperature ( $T_A$ ) of +40°C. Flex uses Telcordia SR-332 Issue 2 Method 1 to calculate the mean steady-state failure rate and standard deviation ( $\sigma$ ).

Telcordia SR-332 Issue 2 also provides techniques to estimate the upper confidence levels of failure rates based on the mean and standard deviation.

Mean steady-state failure rate, $\lambda$	Std. deviation, $\sigma$
214 nFailures/h	34.5 nFailures/h

MTBF (mean value) for the PKB series = 4.7 Mh.

MTBF at 90% confidence level = 3.9 Mh

### Compatibility with RoHS requirements

The products are compatible with the relevant clauses and requirements of the RoHS directive 2002/95/EC and have a maximum concentration value of 0.1% by weight in homogeneous materials for lead, mercury, hexavalent chromium, PBB and PBDE and of 0.01% by weight in homogeneous materials for cadmium.

Exemptions in the RoHS directive utilized in Flex products are found in the Statement of Compliance document.

Flex fulfills and will continuously fulfill all its obligations under regulation (EC) No 1907/2006 concerning the registration, evaluation, authorization and restriction of chemicals (REACH) as they enter into force and is through product materials declarations preparing for the obligations to communicate information on substances in the products.

### Quality Statement

The products are designed and manufactured in an industrial environment where quality systems and methods like ISO 9000, Six Sigma, and SPC are intensively in use to boost the continuous improvements strategy. Infant mortality or early failures in the products are screened out and they are subjected to an ATE-based final test. Conservative design rules, design reviews and product

qualifications, plus the high competence of an engaged work force, contribute to the high quality of the products.

### Warranty

Warranty period and conditions are defined in Flex General Terms and Conditions of Sale.

### Limitation of Liability

Flex does not make any other warranties, expressed or implied including any warranty of merchantability or fitness for a particular purpose (including, but not limited to, use in life support applications, where malfunctions of product can cause injury to a person's health or life).

### © Flex 2017

The information and specifications in this technical specification is believed to be correct at the time of publication. However, no liability is accepted for inaccuracies, printing errors or for any consequences thereof. Flex reserves the right to change the contents of this technical specification at any time without prior notice.

PKB 4000 series

DC/DC converters, Input 36-75 V, Output 30 A/90 W

EN/LZT 146 394 R6A November 2017

© Flex

## Safety Specification

### General information

Flex DC/DC converters and DC/DC regulators are designed in accordance with safety standards IEC/EN/UL 60950-1 *Safety of Information Technology Equipment*.

IEC/EN/UL 60950-1 contains requirements to prevent injury or damage due to the following hazards:

- Electrical shock
- Energy hazards
- Fire
- Mechanical and heat hazards
- Radiation hazards
- Chemical hazards

On-board DC/DC converters and DC/DC regulators are defined as component power supplies. As components they cannot fully comply with the provisions of any safety requirements without "Conditions of Acceptability". Clearance between conductors and between conductive parts of the component power supply and conductors on the board in the final product must meet the applicable safety requirements. Certain conditions of acceptability apply for component power supplies with limited stand-off (see Mechanical Information for further information). It is the responsibility of the installer to ensure that the final product housing these components complies with the requirements of all applicable safety standards and regulations for the final product.

Component power supplies for general use should comply with the requirements in IEC 60950-1, EN 60950-1 and UL 60950-1 *Safety of Information Technology Equipment*. There are other more product related standards, e.g. IEEE 802.3 *CSMA/CD (Ethernet) Access Method*, and ETS-300132-2 *Power supply interface at the input to telecommunications equipment, operated by direct current (dc)*, but all of these standards are based on IEC/EN/UL 60950-1 with regards to safety.

Flex DC/DC converters and DC/DC regulators are UL 60950-1 recognized and certified in accordance with EN 60950-1.

The flammability rating for all construction parts of the products meet requirements for V-0 class material according to IEC 60695-11-10, *Fire hazard testing, test flames* – 50 W horizontal and vertical flame test methods.

The products should be installed in the end-use equipment, in accordance with the requirements of the ultimate application. Normally the output of the DC/DC converter is considered as SELV (Safety Extra Low Voltage) and the input source must be isolated by minimum Double or Reinforced Insulation from the primary

circuit (AC mains) in accordance with IEC/EN/UL 60950-1. **Isolated DC/DC converters**

It is recommended that a slow blow fuse is to be used at the input of each DC/DC converter. If an input filter is used in the circuit the fuse should be placed in front of the input filter.

In the rare event of a component problem that imposes a short circuit on the input source, this fuse will provide the following functions:

- Isolate the fault from the input power source so as not to affect the operation of other parts of the system.
- Protect the distribution wiring from excessive current and power loss thus preventing hazardous overheating.

The galvanic isolation is verified in an electric strength test. The test voltage ( $V_{iso}$ ) between input and output is 1500 Vdc or 2250 Vdc (refer to product specification).

### 24 V DC systems

The input voltage to the DC/DC converter is SELV (Safety Extra Low Voltage) and the output remains SELV under normal and abnormal operating conditions.

### 48 and 60 V DC systems

If the input voltage to the DC/DC converter is 75 Vdc or less, then the output remains SELV (Safety Extra Low Voltage) under normal and abnormal operating conditions.

Single fault testing in the input power supply circuit should be performed with the DC/DC converter connected to demonstrate that the input voltage does not exceed 75 Vdc.

If the input power source circuit is a DC power system, the source may be treated as a TNV-2 circuit and testing has demonstrated compliance with SELV limits in accordance with IEC/EN/UL60950-1.

### Non-isolated DC/DC regulators

The input voltage to the DC/DC regulator is SELV (Safety Extra Low Voltage) and the output remains SELV under normal and abnormal operating conditions.

PKB 4000 series  
DC/DC converters, Input 36-75 V, Output 30 A/90 W

EN/LZT 146 394 R6A November 2017

© Flex

### Absolute Maximum Ratings

Characteristics		min	typ	max	Unit
$T_{ref}$	Operating Temperature (see Thermal Consideration section)	-40		+120	°C
$T_s$	Storage temperature	-55		+125	°C
$V_I$	Input voltage	-0.5		+80	V
$V_{iso}$	Isolation voltage (input to output test voltage)			2250	Vdc
$V_{tr}$	Input voltage transient ( $t_p$ 100 ms)			100	V
$V_{RC}$	Remote Control pin voltage (see Operating Information section)	Positive logic option		6	V
		Negative logic option		40	V
$V_{adj}$	Adjust pin voltage (see Operating Information section)	-0.5		$2 \times V_{oi}$	V

Stress in excess of Absolute Maximum Ratings may cause permanent damage. Absolute Maximum Ratings, sometimes referred to as no destruction limits, are normally tested with one parameter at a time exceeding the limits of Output data or Electrical Characteristics. If exposed to stress above these limits, function and performance may degrade in an unspecified manner.

### Fundamental Circuit Diagram

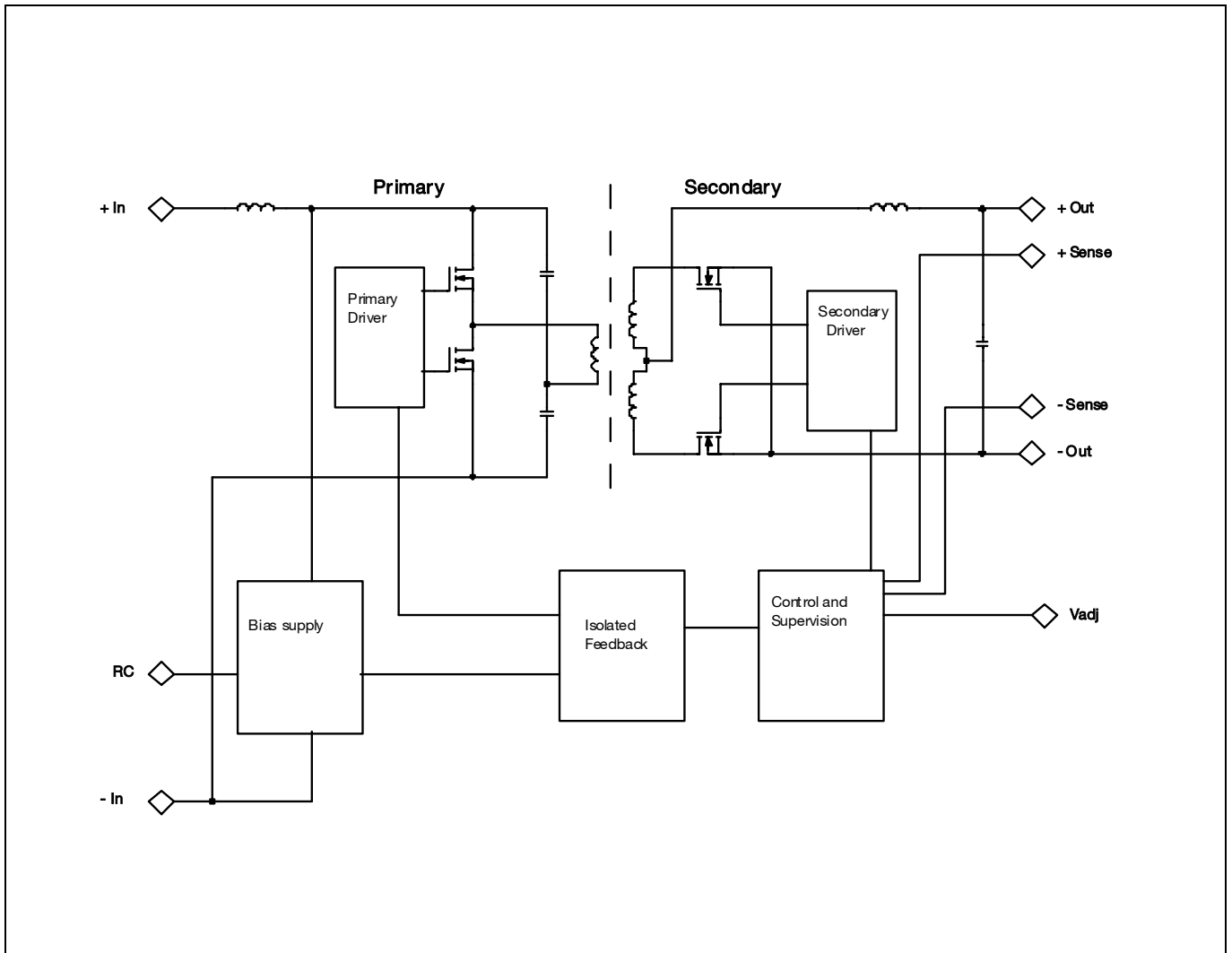

PKB 4000 series  
DC/DC converters, Input 36-75 V, Output 30 A/90 W

EN/LZT 146 394 R6A November 2017

© Flex

### 1.0 V/30 A Electrical Specification

### PKB 4318N PINB

$T_{ref} = -40$  to  $+90^{\circ}\text{C}$ ,  $V_I = 36$  to  $75$  V, sense pins connected to output pins unless otherwise specified under Conditions.

Typical values given at:  $T_{ref} = +25^{\circ}\text{C}$ ,  $V_I = 53$  V,  $I_O = \text{max } I_O$ , unless otherwise specified under Conditions.

Additional  $C_{in} = 0$   $\mu\text{F}$  and  $C_{out} = 0$   $\mu\text{F}$ . See Operating Information section for selection of capacitor types.

Characteristics		Conditions	min	typ	max	Unit
$V_I$	Input voltage range		36		75	V
$V_{loff}$	Turn-off input voltage	Decreasing input voltage	30	31	32	V
$V_{lon}$	Turn-on input voltage	Increasing input voltage	33	34	35	V
$C_I$	Internal input capacitance			2.65		$\mu\text{F}$
$P_O$	Output power	Output voltage initial setting	0		30	W
$\eta$	Efficiency	50 % of max $I_O$		85.1		%
		max $I_O$		81.6		
		50 % of max $I_O$ , $V_I = 48$ V		85.3		
		max $I_O$ , $V_I = 48$ V		81.3		
$P_d$	Power Dissipation	max $I_O$		6.9	8.3	W
$P_{li}$	Input idling power	$I_O = 0$ A, $V_I = 53$ V		1		W
$P_{RC}$	Input standby power	$V_I = 53$ V (turned off with RC)		0.12		W
$f_s$	Switching frequency	0-100 % of max $I_O$		170		kHz

$V_{Oi}$	Output voltage initial setting and accuracy	$T_{ref} = +25^{\circ}\text{C}$ , $V_I = 53$ V, $I_O = 30$ A	0.97	1.00	1.03	V
$V_O$	Output adjust range	See operating information	0.90		1.10	V
	Output voltage tolerance band	10-100 % of max $I_O$	0.96		1.04	V
	Idling voltage	$I_O = 0$ A	0.96		1.04	V
	Line regulation	max $I_O$		0.2	10	mV
	Load regulation	$V_I = 53$ V, 0-100 % of max $I_O$		3	10	mV
$V_{tr}$	Load transient voltage deviation	$V_I = 53$ V, Load step 25-75-25 % of max $I_O$ , $di/dt = 1$ A/ $\mu\text{s}$		$\pm 120$	$\pm 250$	mV
$t_{tr}$	Load transient recovery time	see Note 1		40	160	$\mu\text{s}$
$t_r$	Ramp-up time (from 10-90 % of $V_O$ )	10-100 % of max $I_O$	0.1	0.5	2	ms
$t_s$	Start-up time (from $V_I$ connection to 90 % of $V_O$ )		1	2.4	7	ms
$t_f$	$V_I$ shut-down fall time (from $V_I$ off to 10 % of $V_O$ )	max $I_O$		0.06		ms
		$I_O = 0$ A		8.1		s
$t_{RC}$	RC start-up time	max $I_O$		2.1		ms
	RC shut-down fall time (from RC off to 10 % of $V_O$ )	max $I_O$		0.06		ms
		$I_O = 0$ A		9.1		s
$I_O$	Output current		0		30	A
$I_{lim}$	Current limit threshold	$T_{ref} < \text{max } T_{ref}$	31	36	38	A
$I_{sc}$	Short circuit current	$T_{ref} = 25^{\circ}\text{C}$ , see Note 2		38.5	41	A
$V_{Oac}$	Output ripple & noise	See ripple & noise section, max $I_O$ , $V_{Oi}$		40	80	mVp-p
OVP	Over voltage protection	$T_{ref} = +25^{\circ}\text{C}$ , $V_I = 53$ V, 0-100 % of max $I_O$	1.15	1.3	1.6	V

Note 1: (Cout used at load transient test; 15\*470uF Polymer+1\*470uF electrolytic)

Note 2: See Operating Information section.

PKB 4000 series  
DC/DC converters, Input 36-75 V, Output 30 A/90 W

EN/LZT 146 394 R6A November 2017

© Flex

## 1.0 V/30 A Typical Characteristics

PKB 4318N PINB

### Efficiency

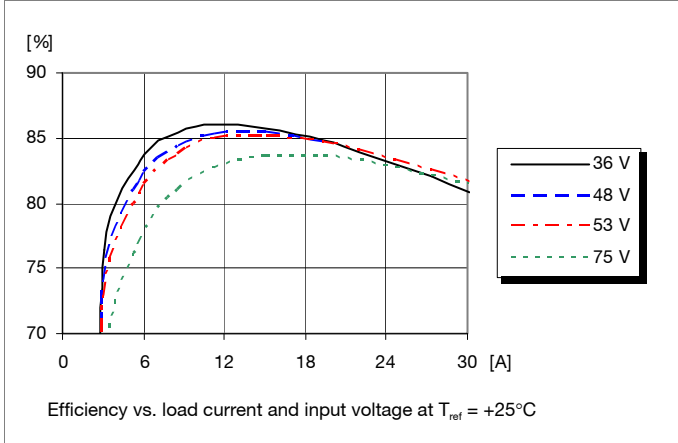

### Power Dissipation

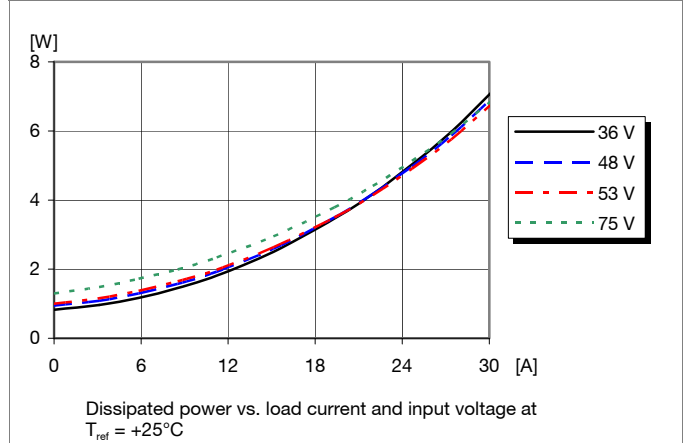

### Output Current Derating

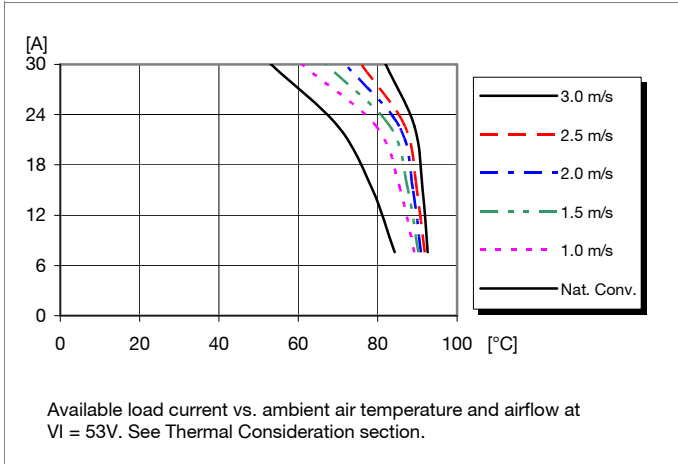

### Thermal Resistance

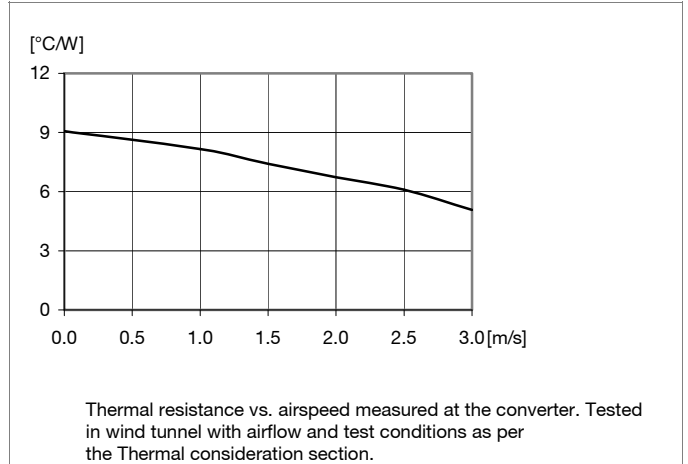

### Output Characteristics

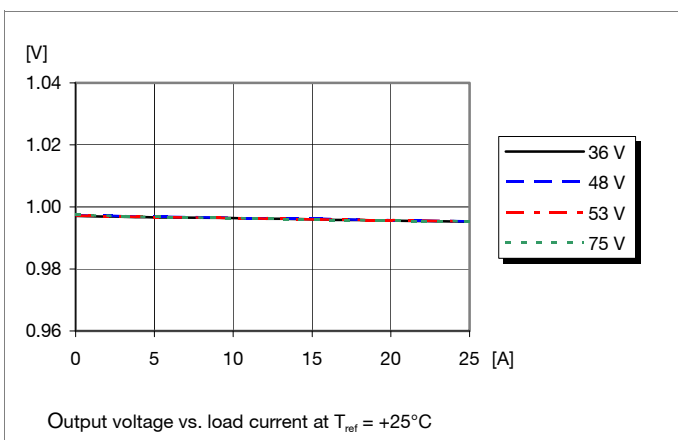

### Current Limit Characteristics

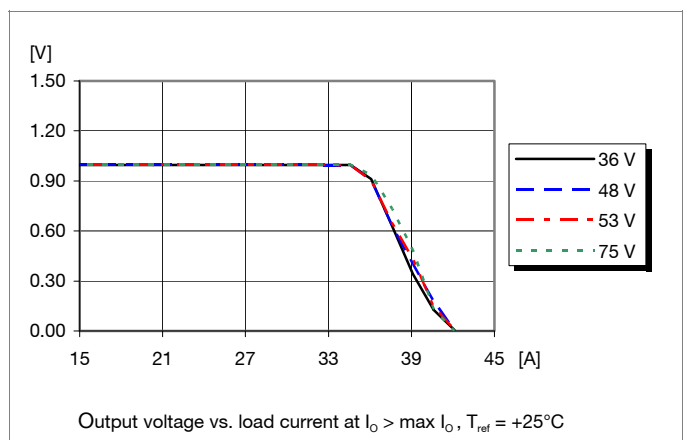

PKB 4000 series  
DC/DC converters, Input 36-75 V, Output 30 A/90 W

EN/LZT 146 394 R6A November 2017

© Flex

### 1.0 V/30 A Typical Characteristics

PKB 4318N PINB

#### Start-up

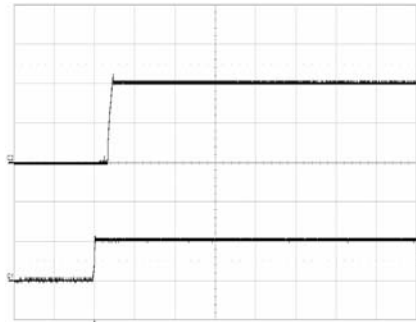

Start-up enabled by connecting  $V_i$  at:  
 $T_{ref} = +25^\circ\text{C}$ ,  $V_i = 53\text{ V}$ ,  
 $I_o = 30\text{ A}$  resistive load.

Top trace: output voltage (0.5 V/div.).  
Bottom trace: input voltage (50 V/div.).  
Time scale: (5 ms/div.).

#### Shut-down

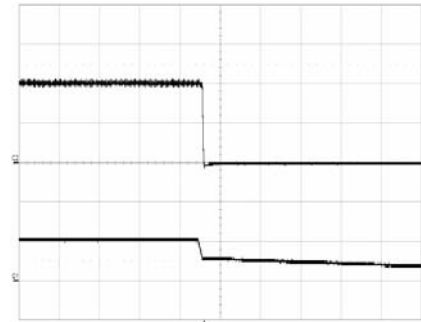

Shut-down enabled by disconnecting  $V_i$  at:  
 $T_{ref} = +25^\circ\text{C}$ ,  $V_i = 53\text{ V}$ ,  
 $I_o = 30\text{ A}$  resistive load.

Top trace: output voltage (0.5 V/div.).  
Bottom trace: input voltage (50 V/div.).  
Time scale: (0.5 ms/div.).

#### Output Ripple & Noise

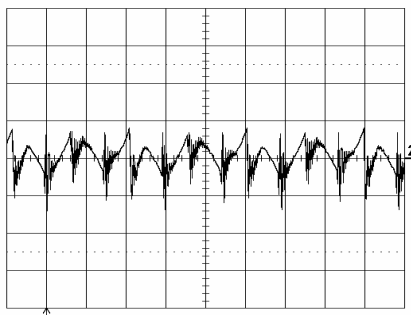

Output voltage ripple at:  
 $T_{ref} = +25^\circ\text{C}$ ,  $V_i = 53\text{ V}$ ,  
 $I_o = 30\text{ A}$  resistive load.

Trace: output voltage (20 mV/div.).  
Time scale: (2 μs/div.).

#### Output Load Transient Response

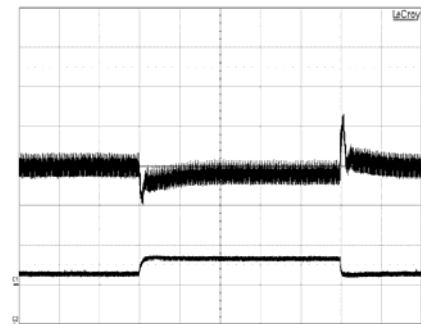

Output voltage response to load current step-  
change (7.5-22.5-7.5 A) at:  
 $T_{ref} = +25^\circ\text{C}$ ,  $V_i = 53\text{ V}$ .

Top trace: output voltage (100 mV/div.).  
Bottom trace: load current (30 A/div.).  
Time scale: (0.1 ms/div.).

#### Output Voltage Adjust (see operating information)

##### Passive adjust

The resistor value for an adjusted output voltage is calculated by using the following equations:

For a desired change of the nominal output voltage, the value of the resistor should be

$$R_{adj} = \left| \frac{V_{adj}}{V_{oi} - V_{adj}} \right| - 1 (k\Omega)$$

Where  $V_{adj}$  is adjusted output voltage, and  $V_{oi}$  is initial output voltage.

Vertical bars indicate absolute value.

PKB 4000 series  
 DC/DC converters, Input 36-75 V, Output 30 A/90 W

EN/LZT 146 394 R6A November 2017

© Flex

**1.2 V/30 A Electrical Specification**
**PKB 4318 PIOBNB**
 $T_{ref} = -40$  to  $+90^{\circ}\text{C}$ ,  $V_I = 36$  to  $75$  V, sense pins connected to output pins unless otherwise specified under Conditions.

 Typical values given at:  $T_{ref} = +25^{\circ}\text{C}$ ,  $V_I = 53$  V,  $I_O = \text{max } I_O$ , unless otherwise specified under Conditions.

 Additional  $C_{in} = 0$   $\mu\text{F}$  and  $C_{out} = 0$   $\mu\text{F}$ . See Operating Information section for selection of capacitor types.

Characteristics		Conditions	min	typ	max	Unit
$V_I$	Input voltage range		36		75	V
$V_{loff}$	Turn-off input voltage	Decreasing input voltage	30.6	30.9	31.1	V
$V_{lon}$	Turn-on input voltage	Increasing input voltage	33.6	34.0	34.2	V
$C_I$	Internal input capacitance			2.65		$\mu\text{F}$
$P_O$	Output power	Output voltage initial setting	0		36	W
$\eta$	Efficiency	50 % of max $I_O$		87		%
		max $I_O$		85		
		50 % of max $I_O$ , $V_I = 48$ V		87		
		max $I_O$ , $V_I = 48$ V		85		
$P_d$	Power Dissipation	max $I_O$		6.4	7.7	W
$P_{li}$	Input idling power	$I_O = 0$ A, $V_I = 53$ V		1.2		W
$P_{RC}$	Input standby power	$V_I = 53$ V (turned off with RC)		0.14		W
$f_s$	Switching frequency	0-100 % of max $I_O$		170		kHz

$V_{Oi}$	Output voltage initial setting and accuracy	$T_{ref} = +25^{\circ}\text{C}$ , $V_I = 53$ V, $I_O = 20$ A	1.18	1.20	1.22	V
$V_O$	Output adjust range	See operating information	1.08		1.32	V
	Output voltage tolerance band	10-100 % of max $I_O$	1.16		1.23	V
	Idling voltage	$I_O = 0$ A	1.16		1.23	V
	Line regulation	max $I_O$		3	10	mV
	Load regulation	$V_I = 53$ V, 0-100 % of max $I_O$		3	10	mV
$V_{tr}$	Load transient voltage deviation	$V_I = 53$ V, Load step 25-75-25 % of max $I_O$ , $di/dt = 1$ A/ $\mu\text{s}$		$\pm 260$	$\pm 320$	mV
$t_{tr}$	Load transient recovery time			50	150	$\mu\text{s}$
$t_r$	Ramp-up time (from 10-90 % of $V_O$ )	10-100 % of max $I_O$	4	7	10	ms
$t_s$	Start-up time (from $V_I$ connection to 90 % of $V_O$ )		7	13	43	ms
$t_f$	$V_I$ shut-down fall time (from $V_I$ off to 10 % of $V_O$ )	max $I_O$		0.04		ms
		$I_O = 0$ A		8.1		s
$t_{RC}$	RC start-up time	max $I_O$		11.4		ms
	RC shut-down fall time (from RC off to 10 % of $V_O$ )	max $I_O$		0.01		ms
		$I_O = 0$ A		11		s
$I_O$	Output current		0		30	A
$I_{lim}$	Current limit threshold	$T_{ref} < \text{max } T_{ref}$	32	34	37	A
$I_{sc}$	Short circuit current	$T_{ref} = 25^{\circ}\text{C}$ , see Note 1		38.5	39	A
$V_{Oac}$	Output ripple & noise	See ripple & noise section, max $I_O$ , $V_{Oi}$		50	80	mVp-p
OVP	Over voltage protection	$T_{ref} = +25^{\circ}\text{C}$ , $V_I = 53$ V, 0-100 % of max $I_O$	1.4	1.5	1.8	V

 Note 1:  $V_O < 0.5$  V



PKB 4000 series  
DC/DC converters, Input 36-75 V, Output 30 A/90 W

EN/LZT 146 394 R6A November 2017

© Flex

### 1.2V/30 A Typical Characteristics

PKB 4318 PIOBNB

#### Efficiency

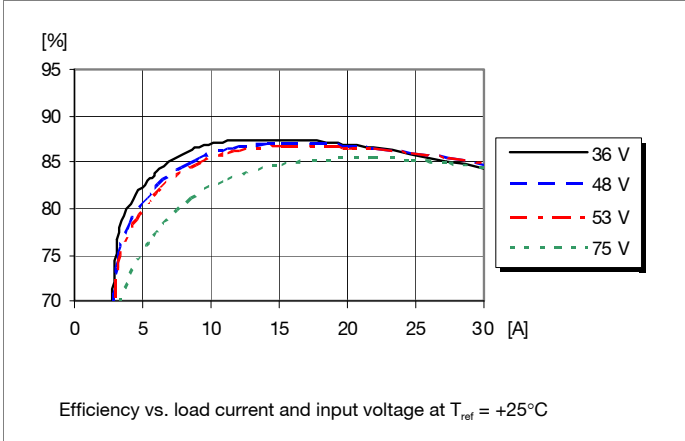

#### Power Dissipation

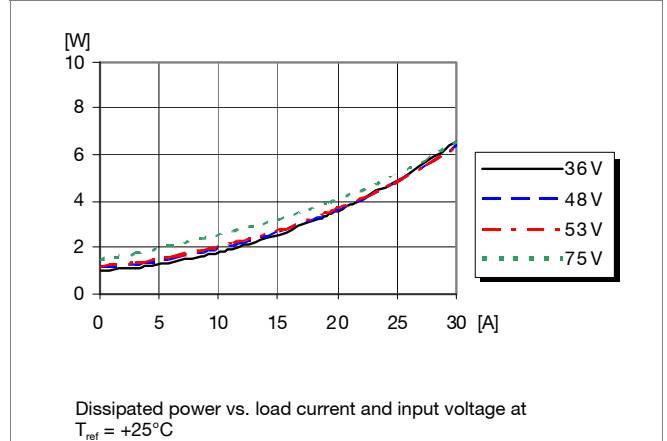

#### Output Current Derating

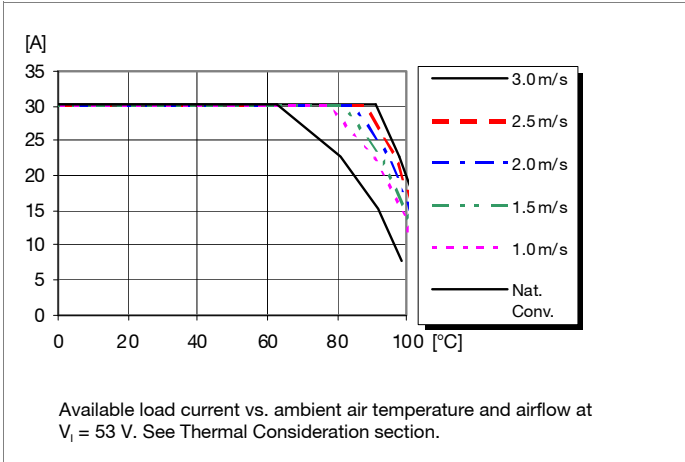

#### Thermal Resistance

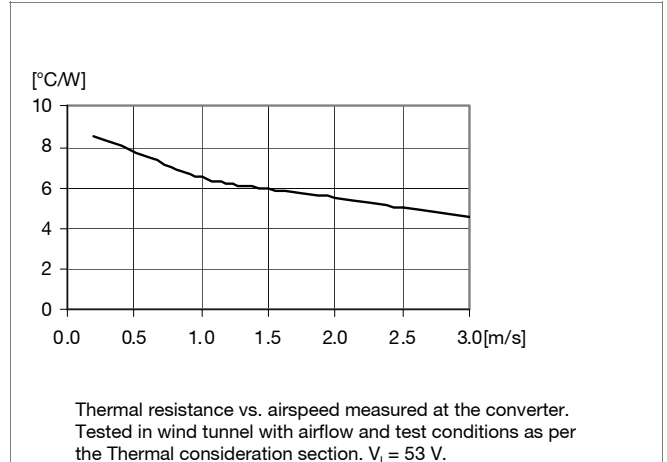

#### Output Characteristics

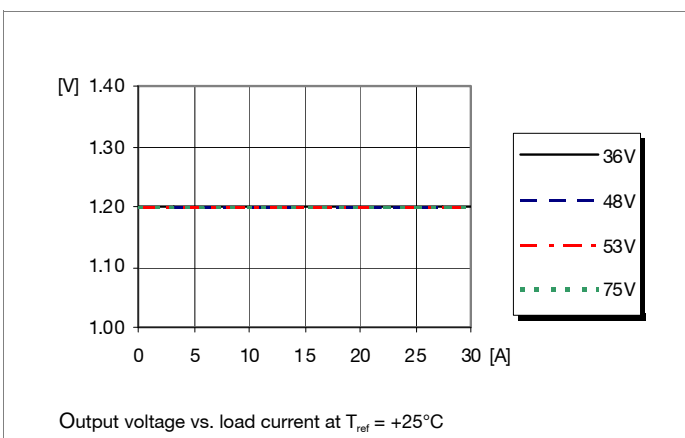

#### Current Limit Characteristics

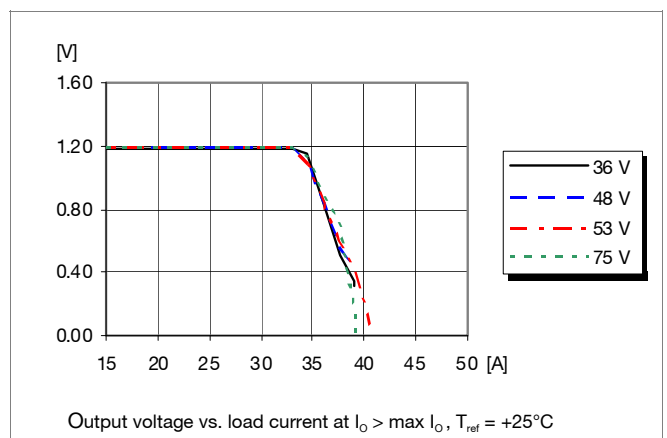

PKB 4000 series  
DC/DC converters, Input 36-75 V, Output 30 A/90 W

EN/LZT 146 394 R6A November 2017

© Flex

### 1.2V/30 A Typical Characteristics

PKB 4318 PIOBNB

#### Start-up



Start-up enabled by connecting  $V_i$  at:  
 $T_{ref} = +25^\circ\text{C}$ ,  $V_i = 53\text{ V}$ ,  
 $I_o = 30\text{ A}$  resistive load.

Top trace: output voltage (0.5 V/div.).  
Bottom trace: input voltage (50 V/div.).  
Time scale: (5 ms/div.).

#### Shut-down

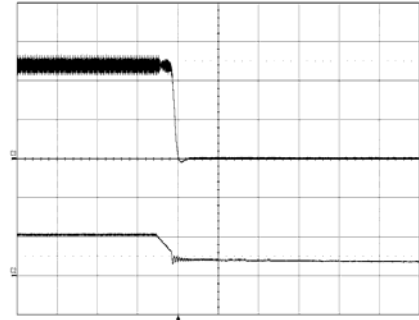

Shut-down enabled by disconnecting  $V_i$  at:  
 $T_{ref} = +25^\circ\text{C}$ ,  $V_i = 53\text{ V}$ ,  
 $I_o = 30\text{ A}$  resistive load.

Top trace: output voltage (0.5 V/div.).  
Bottom trace: input voltage (50 V/div.).  
Time scale: (0.1 ms/div.).

#### Output Ripple & Noise

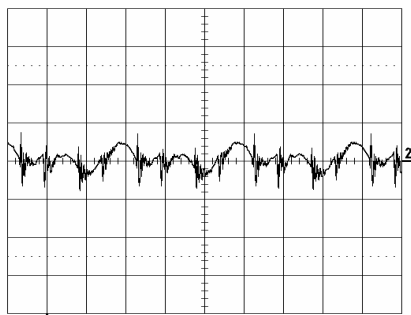

Output voltage ripple at:  
 $T_{ref} = +25^\circ\text{C}$ ,  $V_i = 53\text{ V}$ ,  
 $I_o = 30\text{ A}$  resistive load.

Trace: output voltage (20 mV/div.).  
Time scale: (2 μs/div.).

#### Output Load Transient Response

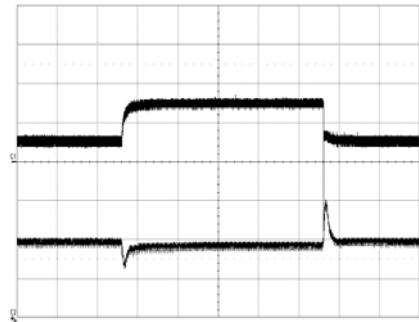

Output voltage response to load current step-change (5.5-17.5-5.5 A) at:  
 $T_{ref} = +25^\circ\text{C}$ ,  $V_i = 53\text{ V}$ .

Top trace: output voltage (200 mV/div.).  
Bottom trace: load current (10 A/div.).  
Time scale: (0.1 ms/div.).

#### Output Voltage Adjust (see operating information)

##### Passive adjust

The resistor value for an adjusted output voltage is calculated by using the following equations:

Output Voltage Adjust Upwards, Increase:

$$R_{adj} = \left( \frac{5.11 \times 1.2 (100 + \Delta\%) - 511}{0.6 \times \Delta\%} - 10.22 \right) \text{ k}\Omega$$

Output Voltage Adjust Downwards, Decrease:

$$R_{adj} = 5.11 \times \left( \frac{100}{\Delta\%} - 2 \right) \text{ k}\Omega$$

Example: Increase 4%  $\Rightarrow V_{out} = 1.25\text{ Vdc}$

$$\left( \frac{5.11 \times 1.2 (100 + 4) - 511}{0.6 \times 4} - 10.22 \right) \text{ k}\Omega = 127.7 \text{ k}\Omega$$

Decrease 4%  $\Rightarrow V_{out} = 1.15\text{ Vdc}$

$$5.11 \times \left( \frac{100}{4} - 2 \right) \text{ k}\Omega = 117.5 \text{ k}\Omega$$

PKB 4000 series  
DC/DC converters, Input 36-75 V, Output 30 A/90 W

EN/LZT 146 394 R6A November 2017

© Flex

## 1.5 V/30 A Electrical Specification

## PKB 4418 PIOANB

$T_{ref} = -40$  to  $+90^{\circ}\text{C}$ ,  $V_I = 36$  to  $75$  V, sense pins connected to output pins unless otherwise specified under Conditions.

Typical values given at:  $T_{ref} = +25^{\circ}\text{C}$ ,  $V_I = 53$  V,  $I_O = \text{max } I_O$ , unless otherwise specified under Conditions.

Additional  $C_{in} = 0$   $\mu\text{F}$  and  $C_{out} = 0$   $\mu\text{F}$ . See Operating Information section for selection of capacitor types.

Characteristics		Conditions	min	typ	max	Unit
$V_I$	Input voltage range		36		75	V
$V_{loff}$	Turn-off input voltage	Decreasing input voltage	30	31	32	V
$V_{Ion}$	Turn-on input voltage	Increasing input voltage	33	34	35	V
$C_I$	Internal input capacitance			2.65		$\mu\text{F}$
$P_O$	Output power	Output voltage initial setting	0		45	W
$\eta$	Efficiency	50 % of $\text{max } I_O$		88.5		%
		$\text{max } I_O$		86.6		
		50 % of $\text{max } I_O$ , $V_I = 48$ V		88.8		
		$\text{max } I_O$ , $V_I = 48$ V		86.5		
$P_d$	Power Dissipation	$\text{max } I_O$		7.0	8.4	W
$P_{li}$	Input idling power	$I_O = 0$ A, $V_I = 53$ V		1.3		W
$P_{RC}$	Input standby power	$V_I = 53$ V (turned off with RC)		0.11		W
$f_s$	Switching frequency	0-100 % of $\text{max } I_O$		167		kHz

$V_{Oi}$	Output voltage initial setting and accuracy	$T_{ref} = +25^{\circ}\text{C}$ , $V_I = 53$ V, $I_O = 20$ A	1.48	1.50	1.53	V
$V_O$	Output adjust range	See operating information	1.20		1.65	V
	Output voltage tolerance band	10-100 % of $\text{max } I_O$	1.47		1.54	V
	Idling voltage	$I_O = 0$ A	1.47		1.54	V
	Line regulation	$\text{max } I_O$		3	10	mV
	Load regulation	$V_I = 53$ V, 0-100 % of $\text{max } I_O$		3	10	mV
$V_{tr}$	Load transient voltage deviation	$V_I = 53$ V, Load step 25-75-25 % of $\text{max } I_O$ , $di/dt = 3$ A/ $\mu\text{s}$		$\pm 350$	$\pm 400$	mV
$t_{tr}$	Load transient recovery time			40	130	$\mu\text{s}$
$t_r$	Ramp-up time (from 10-90 % of $V_{Oi}$ )	10-100 % of $\text{max } I_O$	1	9	14	ms
$t_s$	Start-up time (from $V_I$ connection to 90 % of $V_{Oi}$ )		4	12	22	ms
$t_f$	$V_I$ shut-down fall time (from $V_I$ off to 10 % of $V_{Oi}$ )	$\text{max } I_O$		0.04		ms
		$I_O = 0$ A		13.9		s
$t_{RC}$	RC start-up time	$\text{max } I_O$		13.4		ms
	RC shut-down fall time (from RC off to 10 % of $V_{Oi}$ )	$\text{max } I_O$		0.02		ms
		$I_O = 0$ A		17		s
$I_O$	Output current		0		30	A
$I_{lim}$	Current limit threshold	$T_{ref} < \text{max } T_{ref}$	31	33	39	A
$I_{sc}$	Short circuit current	$T_{ref} = 25^{\circ}\text{C}$ , see Note 1		38	43	A
$V_{Oac}$	Output ripple & noise	See ripple & noise section, $\text{max } I_O$ , $V_{Oi}$		50	80	mVp-p
OVP	Over voltage protection	$T_{ref} = +25^{\circ}\text{C}$ , $V_I = 53$ V, 0-100 % of $\text{max } I_O$	1.8	1.9	2.1	V

Note 1:  $V_o < 0.5$  V

PKB 4000 series  
DC/DC converters, Input 36-75 V, Output 30 A/90 W

EN/LZT 146 394 R6A November 2017

© Flex

## 1.5V/30 A Typical Characteristics

PKB 4418 PIOANB

### Efficiency

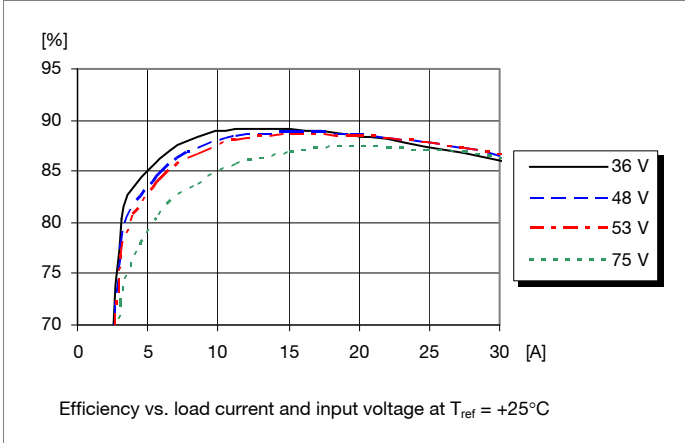

### Power Dissipation

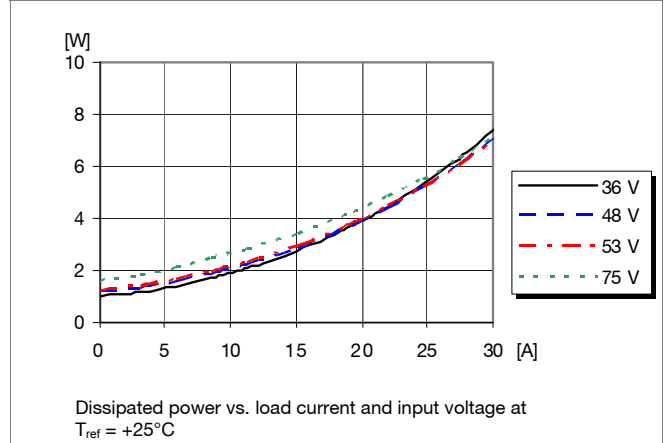

### Output Current Derating

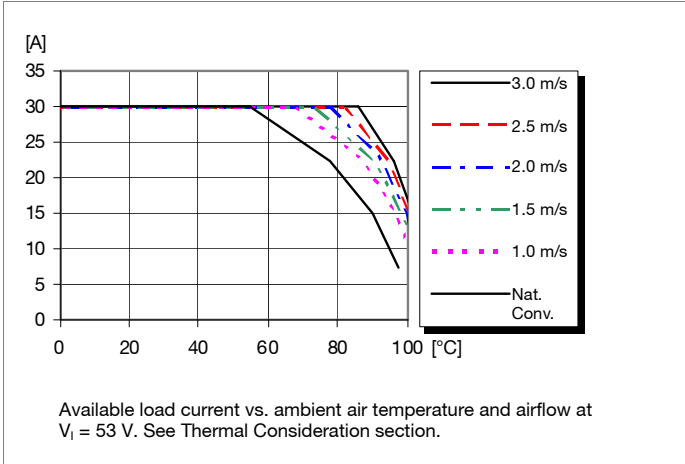

### Thermal Resistance

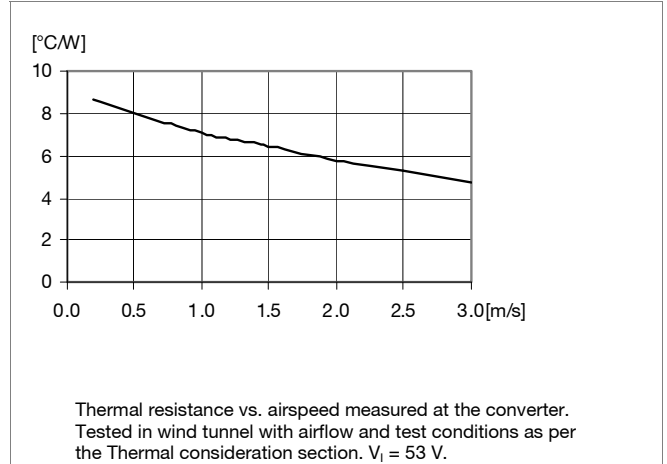

### Output Characteristics

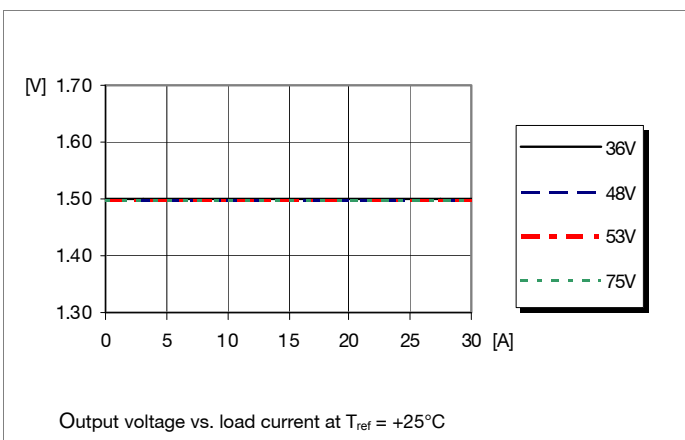

### Current Limit Characteristics

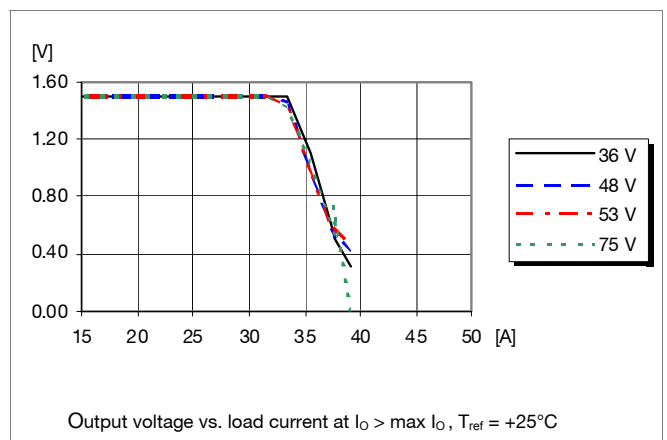

PKB 4000 series  
DC/DC converters, Input 36-75 V, Output 30 A/90 W

EN/LZT 146 394 R6A November 2017

© Flex

### 1.5V/30 A Typical Characteristics

### PKB 4418 PIOANB

#### Start-up

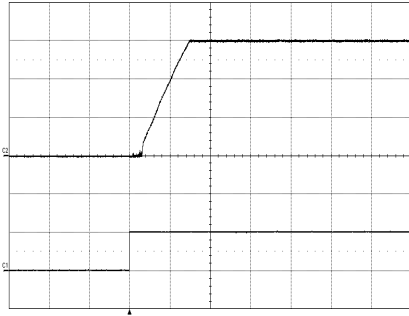

Start-up enabled by connecting  $V_i$  at:  
 $T_{ref} = +25^\circ\text{C}$ ,  $V_i = 53\text{ V}$ ,  
 $I_o = 30\text{ A}$  resistive load.

Top trace: output voltage (0.5 V/div.).  
Bottom trace: input voltage (20 V/div.).  
Time scale: (5 ms/div.).

#### Shut-down

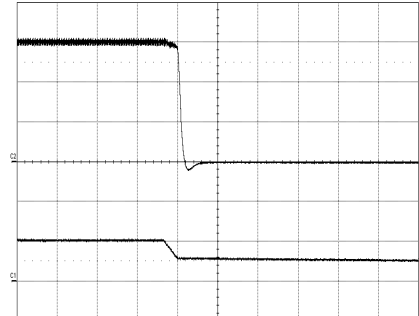

Shut-down enabled by disconnecting  $V_i$  at:  
 $T_{ref} = +25^\circ\text{C}$ ,  $V_i = 53\text{ V}$ ,  
 $I_o = 30\text{ A}$  resistive load.

Top trace: output voltage (0.5 V/div.).  
Bottom trace: input voltage (50 V/div.).  
Time scale: (0.1 ms/div.).

#### Output Ripple & Noise

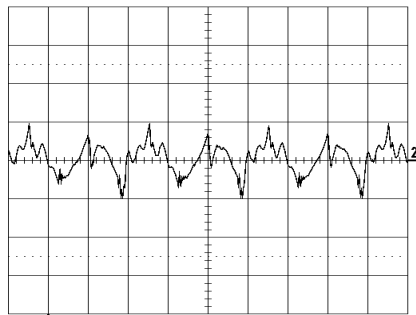

Output voltage ripple at:  
 $T_{ref} = +25^\circ\text{C}$ ,  $V_i = 53\text{ V}$ ,  
 $I_o = 30\text{ A}$  resistive load.

Trace: output voltage (20 mV/div.).  
Time scale: (2  $\mu\text{s}$ /div.).

#### Output Load Transient Response



Output voltage response to load current step-  
change (7.5-22.5-7.5 A) at:  
 $T_{ref} = +25^\circ\text{C}$ ,  $V_i = 53\text{ V}$ .

Top trace: output voltage (200 mV/div.).  
Bottom trace: load current (10 A/div.).  
Time scale: (0.1 ms/div.).

#### Output Voltage Adjust (see operating information)

##### Passive adjust

The resistor value for an adjusted output voltage is calculated by using the following equations:

Output Voltage Adjust Upwards, Increase:

$$R_{adj} = \left( \frac{5.11 \times 1.5 (100 + \Delta\%) - 511}{1.225 \times \Delta\%} - 10.22 \right) \text{ k}\Omega$$

Output Voltage Adjust Downwards, Decrease:

$$R_{adj} = 5.11 \times \left( \frac{100}{\Delta\%} - 2 \right) \text{ k}\Omega$$

Example: Increase 4%  $\Rightarrow V_{out} = 1.56\text{ Vdc}$

$$\left( \frac{5.11 \times 1.5 (100 + 4)}{1.225 \times 4} - \frac{511}{4} - 10.22 \right) \text{ k}\Omega = 24.7 \text{ k}\Omega$$

Decrease 4%  $\Rightarrow V_{out} = 1.44\text{ Vdc}$

$$5.11 \times \left( \frac{100}{4} - 2 \right) \text{ k}\Omega = 117.5 \text{ k}\Omega$$

PKB 4000 series DC/DC converters, Input 36-75 V, Output 30 A/90 W	EN/LZT 146 394 R6A November 2017
	© Flex

## 1.8 V/25 A Electrical Specification

## PKB 4418 PINB

$T_{ref} = -40$  to  $+90^{\circ}\text{C}$ ,  $V_I = 36$  to  $75$  V, sense pins connected to output pins unless otherwise specified under Conditions.

Typical values given at:  $T_{ref} = +25^{\circ}\text{C}$ ,  $V_I = 53$  V,  $I_O = \text{max } I_O$ , unless otherwise specified under Conditions.

Additional  $C_{in} = 0$   $\mu\text{F}$  and  $C_{out} = 0$   $\mu\text{F}$ . See Operating Information section for selection of capacitor types.

Characteristics		Conditions	min	typ	max	Unit
$V_I$	Input voltage range		36		75	V
$V_{loff}$	Turn-off input voltage	Decreasing input voltage	30	31	32	V
$V_{lon}$	Turn-on input voltage	Increasing input voltage	33	34	35	V
$C_I$	Internal input capacitance			3.35		$\mu\text{F}$
$P_O$	Output power	Output voltage initial setting	0		45	W
$\eta$	Efficiency	50 % of $\text{max } I_O$		90		%
		$\text{max } I_O$		89		
		50 % of $\text{max } I_O$ , $V_I = 48$ V		89.5		
		$\text{max } I_O$ , $V_I = 48$ V		89		
$P_d$	Power Dissipation	$\text{max } I_O$		5.5	7.5	W
$P_{ii}$	Input idling power	$I_O = 0$ A, $V_I = 53$ V		1.5		W
$P_{RC}$	Input standby power	$V_I = 53$ V (turned off with RC)		0.12		W
$f_s$	Switching frequency	0-100 % of $\text{max } I_O$		195		kHz

$V_{Oi}$	Output voltage initial setting and accuracy	$T_{ref} = +25^{\circ}\text{C}$ , $V_I = 53$ V, $I_O = 25$ A	1.76	1.8	1.83	V
$V_O$	Output adjust range	See operating information	1.44		1.98	V
	Output voltage tolerance band	10-100 % of $\text{max } I_O$	1.76		1.84	V
	Idling voltage	$I_O = 0$ A	1.77		1.84	V
	Line regulation	$\text{max } I_O$		3	10	mV
	Load regulation	$V_I = 53$ V, 0-100 % of $\text{max } I_O$		3	10	mV
$V_{tr}$	Load transient voltage deviation	$V_I = 53$ V, Load step 25-75-25 % of $\text{max } I_O$ , $di/dt = 1$ A/ $\mu\text{s}$		$\pm 250$	$\pm 350$	mV
$t_{tr}$	Load transient recovery time			30	100	$\mu\text{s}$
$t_r$	Ramp-up time (from 10-90 % of $V_{O_i}$ )	10-100 % of $\text{max } I_O$	3	8	15	ms
$t_s$	Start-up time (from $V_I$ connection to 90 % of $V_{O_i}$ )		6	14	25	ms
$t_f$	$V_I$ shut-down fall time (from $V_I$ off to 10 % of $V_{O_i}$ )	$\text{max } I_O$		0.05		ms
		$I_O = 0$ A		2.5		s
$t_{RC}$	RC start-up time	$\text{max } I_O$		12		ms
	RC shut-down fall time (from RC off to 10 % of $V_{O_i}$ )	$\text{max } I_O$		0.04		ms
		$I_O = 0$ A		2.5		s
$I_O$	Output current		0		25	A
$I_{lim}$	Current limit threshold	$T_{ref} < \text{max } T_{ref}$	26	30	35	A
$I_{sc}$	Short circuit current	$T_{ref} = 25^{\circ}\text{C}$ , see Note 1		35	38	A
$V_{Oac}$	Output ripple & noise	See ripple & noise section, $\text{max } I_O$ , $V_{O_i}$		30	70	mVp-p
OVP	Over voltage protection	$T_{ref} = +25^{\circ}\text{C}$ , $V_I = 53$ V, 0-100 % of $\text{max } I_O$	2.1	2.2	2.5	V

Note 1:  $V_o < 0.5$  V

PKB 4000 series  
DC/DC converters, Input 36-75 V, Output 30 A/90 W

EN/LZT 146 394 R6A November 2017

© Flex

## 1.8 V/25 A Typical Characteristics

PKB 4418 PINB

### Efficiency

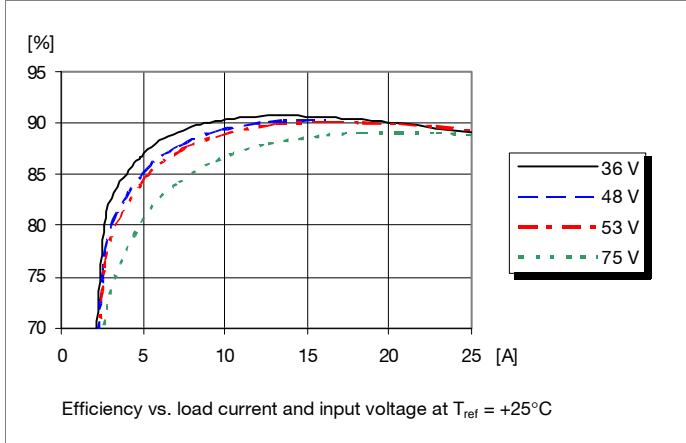

### Power Dissipation

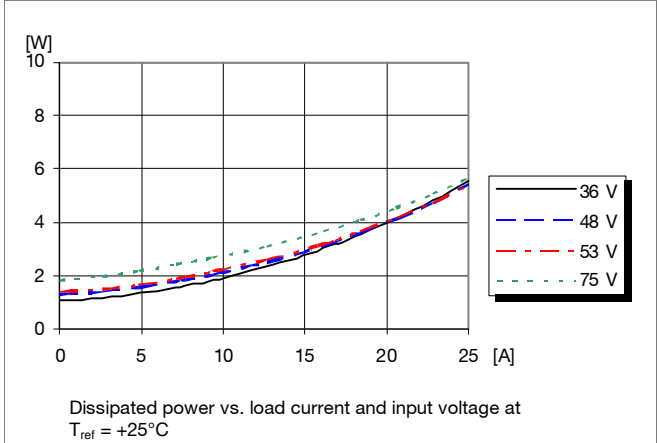

### Output Current Derating

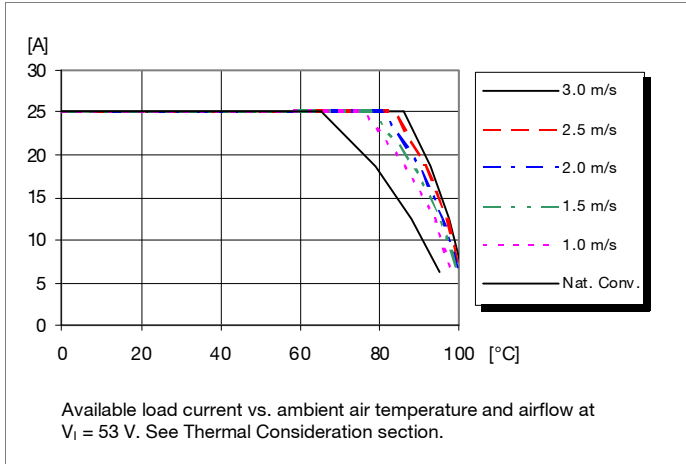

### Thermal Resistance

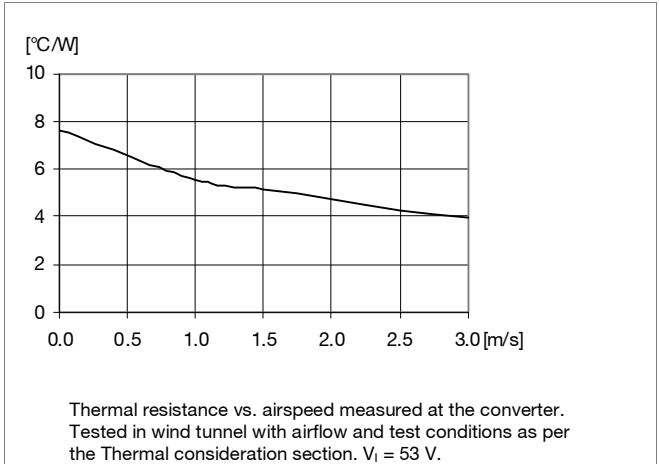

### Output Characteristics

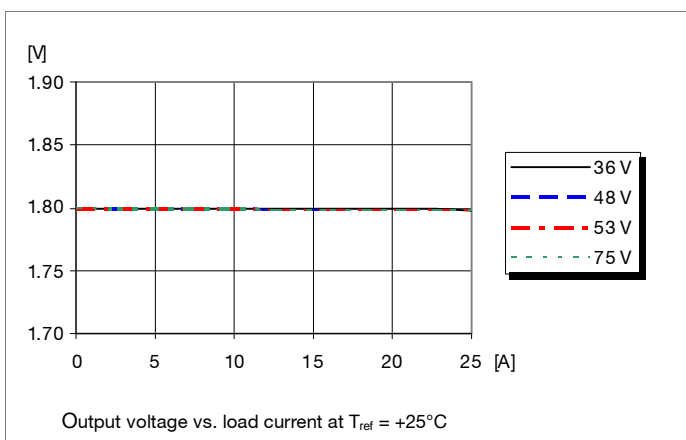

### Current Limit Characteristics

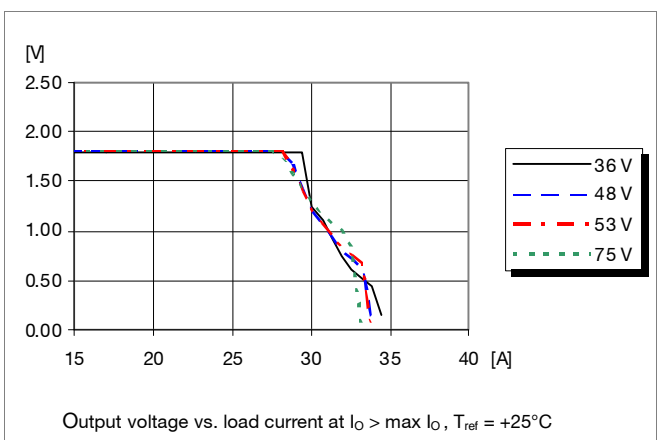

PKB 4000 series  
DC/DC converters, Input 36-75 V, Output 30 A/90 W

EN/LZT 146 394 R6A November 2017

© Flex

### 1.8 V/25 A Typical Characteristics

PKB 4418 PINB

#### Start-up

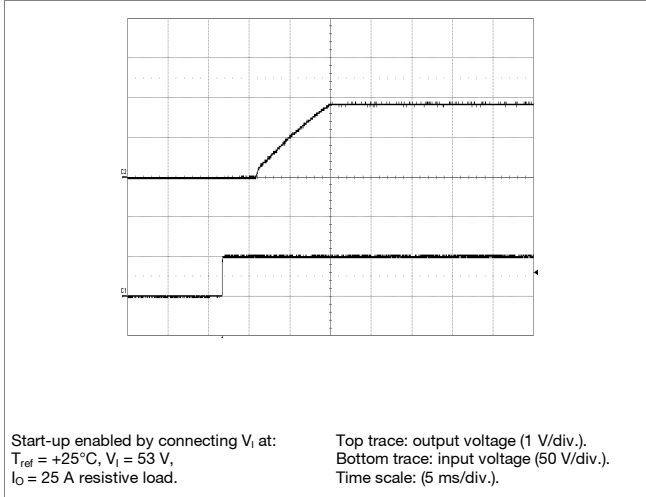

#### Shut-down

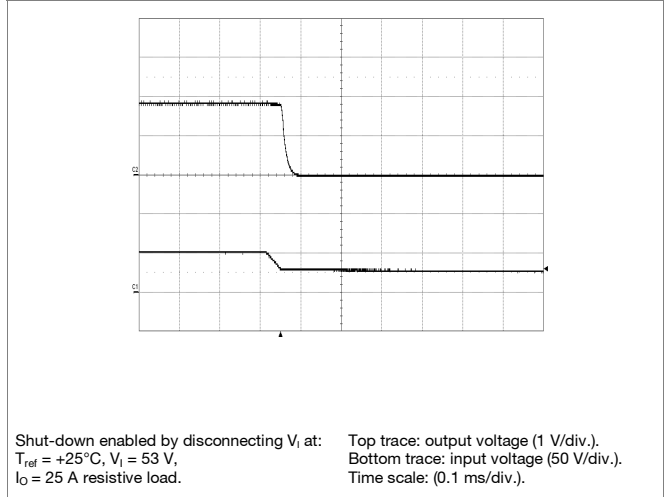

#### Output Ripple & Noise

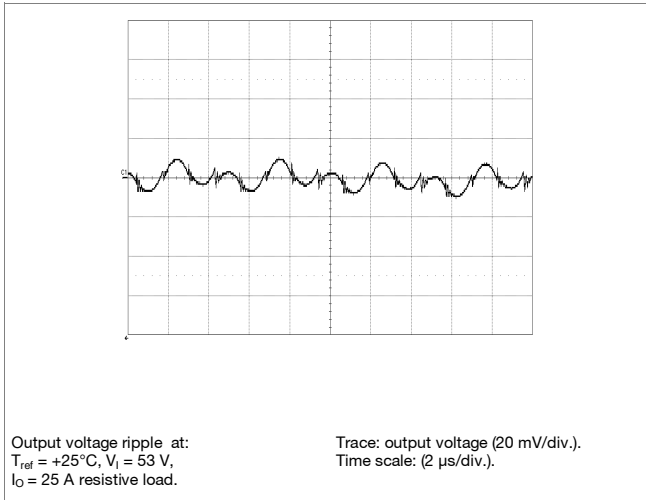

#### Output Load Transient Response

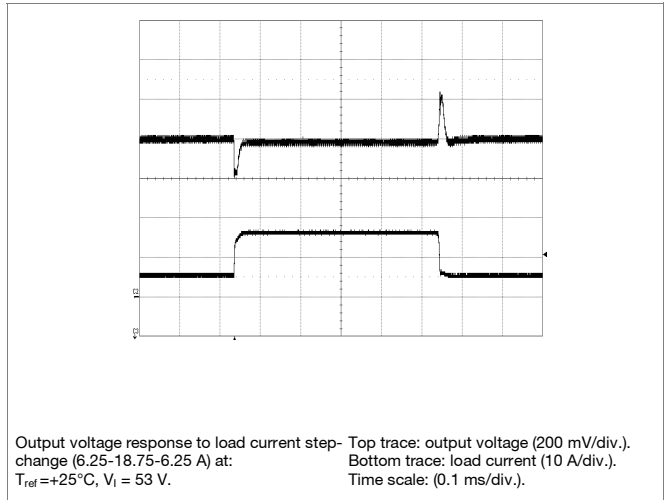

### Output Voltage Adjust (see operating information)

#### Passive adjust

The resistor value for an adjusted output voltage is calculated by using the following equations:

Output Voltage Adjust Upwards, Increase:

$$R_{adj} = \left( \frac{5.11 \times 1.8(100 + \Delta\%)}{1.225 \times \Delta\%} - \frac{511}{\Delta\%} - 10.22 \right) \text{ k}\Omega$$

Example: Increase 4%  $\Rightarrow V_{out} = 1.872\text{ Vdc}$

$$\left( \frac{5.11 \times 1.8(100 + 4)}{1.225 \times 4} - \frac{511}{4} - 10.22 \right) \text{ k}\Omega = 57.3\text{ k}\Omega$$

Output Voltage Adjust Downwards, Decrease:

$$R_{adj} = 5.11 \left( \frac{100}{\Delta\%} - 2 \right) \text{ k}\Omega$$

Example: Decrease 20%  $\Rightarrow V_{out} = 1.44\text{ Vdc}$

$$5.11 \left( \frac{100}{20} - 2 \right) \text{ k}\Omega = 15.3\text{ k}\Omega$$



PKB 4000 series DC/DC converters, Input 36-75 V, Output 30 A/90 W	EN/LZT 146 394 R6A November 2017
	© Flex

## 2.5 V/25 A Electrical Specification

**PKB4619 PINB**
 $T_{ref} = -40$  to  $+90^{\circ}\text{C}$ ,  $V_I = 36$  to  $75$  V, sense pins connected to output pins unless otherwise specified under Conditions.

 Typical values given at:  $T_{ref} = +25^{\circ}\text{C}$ ,  $V_I = 53$  V, max  $I_O$ , unless otherwise specified under Conditions.

 Additional  $C_{in} = 0\mu\text{F}$  and  $C_{out} = 0\mu\text{F}$ . See Operating Information section for selection of capacitor types.

Characteristics		Conditions	min	typ	max	Unit
$V_I$	Input voltage range		36		75	V
$V_{loff}$	Turn-off input voltage	Decreasing input voltage	30	31	32	V
$V_{lon}$	Turn-on input voltage	Increasing input voltage	33	34	35	V
$C_I$	Internal input capacitance			3.35		$\mu\text{F}$
$P_O$	Output power	Output voltage initial setting	0		62.5	W
$\eta$	Efficiency	50 % of max $I_O$		89.6		%
		max $I_O$		89.5		
		50 % of max $I_O$ , $V_I = 48$ V		90.0		
		max $I_O$ , $V_I = 48$ V		89.5		
$P_d$	Power Dissipation	max $I_O$		7.4	9.4	W
$P_{li}$	Input idling power	$I_O = 0$ A, $V_I = 53$ V		2.1		W
$P_{RC}$	Input standby power	$V_I = 53$ V (turned off with RC)		0.118		W
$f_s$	Switching frequency	0-100 % of max $I_O$		198		kHz

$V_{Oi}$	Output voltage initial setting and accuracy	$T_{ref} = +25^{\circ}\text{C}$ , $V_I = 53$ V, $I_O = 15$ A	2.45	2.5	2.55	V
$V_O$	Output adjust range	See operating information	2.00		2.75	V
	Output voltage tolerance band	10-100 % of max $I_O$	2.40		2.60	V
	Idling voltage	$I_O = 0$ A	2.45		2.55	V
	Line regulation	max $I_O$		3	10	mV
	Load regulation	$V_I = 53$ V, 0-100 % of max $I_O$		3	10	mV
$V_{tr}$	Load transient voltage deviation	$V_I = 53$ V, Load step 25-75-25 % of max $I_O$ , $di/dt = 1$ A/ $\mu\text{s}$		$\pm 300$	$\pm 400$	mV
$t_{tr}$	Load transient recovery time			50	200	$\mu\text{s}$
$t_r$	Ramp-up time (from 10-90 % of $V_{Oi}$ )	10-100 % of max $I_O$	3	11	17	ms
$t_s$	Start-up time (from $V_I$ connection to 90 % of $V_{Oi}$ )		6	14	21	ms
$t_f$	$V_I$ shut-down fall time (from $V_I$ off to 10 % of $V_{Oi}$ )	max $I_O$		0.062		ms
		$I_O = 0$ A		8		s
$t_{RC}$	RC start-up time	max $I_O$		12		ms
	RC shut-down fall time (from RC off to 10 % of $V_{Oi}$ )	max $I_O$		0.13		ms
		$I_O = 0$ A		8		s
$I_O$	Output current		0		25	A
$I_{lim}$	Current limit threshold	$T_{ref} < \text{max } T_{ref}$	27	31	35	A
$I_{sc}$	Short circuit current	$T_{ref} = 25^{\circ}\text{C}$ ,		37	41	A
$V_{Oac}$	Output ripple & noise	See ripple & noise section, max $I_O$ , $V_{Oi}$		40	80	mVp-p
OVP	Over voltage protection	$T_{ref} = +25^{\circ}\text{C}$ , $V_I = 53$ V, 0-100 % of max $I_O$	2.9	3.1	4.0	V

PKB 4000 series  
DC/DC converters, Input 36-75 V, Output 30 A/90 W

EN/LZT 146 394 R6A November 2017

© Flex

## 2.5 V/25 A Typical Characteristics

PKB4619 PINB

### Efficiency

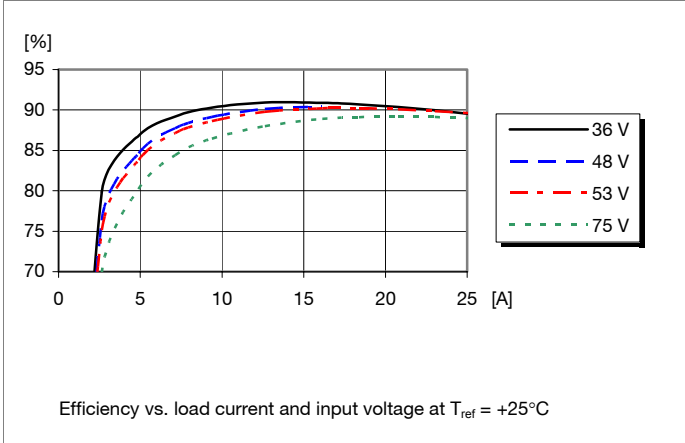

### Power Dissipation

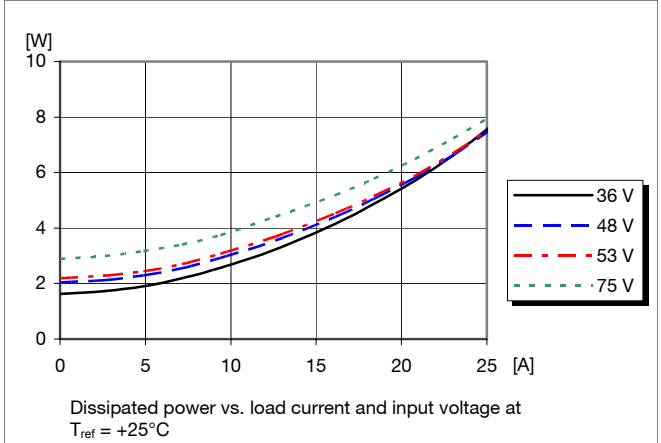

### Output Current Derating

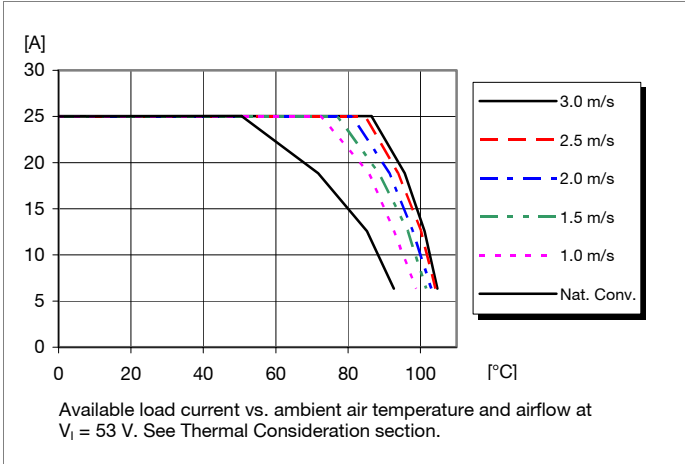

### Thermal Resistance

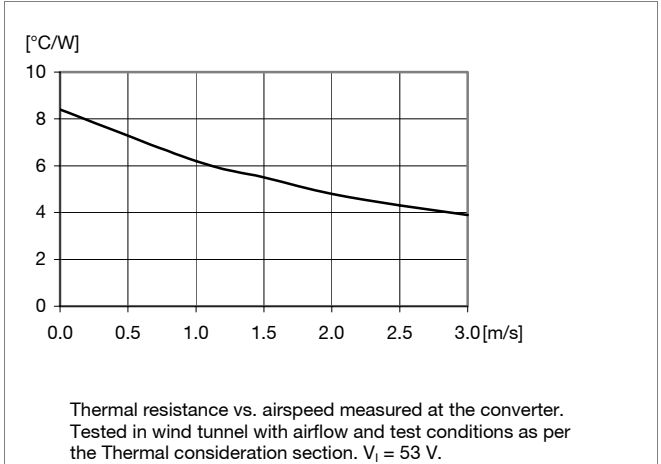

### Output Characteristics

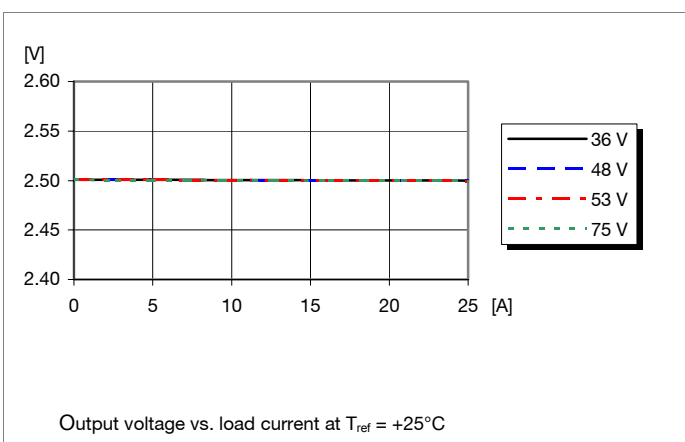

### Current Limit Characteristics

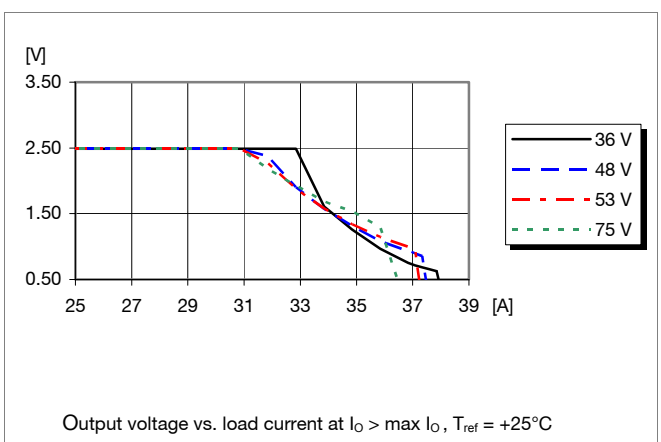

PKB 4000 series  
DC/DC converters, Input 36-75 V, Output 30 A/90 W

EN/LZT 146 394 R6A November 2017

© Flex

### 2.5 V/25 A Typical Characteristics

PKB4619 PINB

#### Start-up

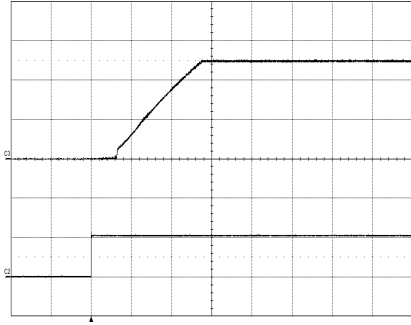

Start-up enabled by connecting  $V_i$  at:  
 $T_{ref} = +25^\circ\text{C}$ ,  $V_i = 53\text{ V}$ ,  
 $I_O = 25\text{ A}$  resistive load.

Top trace: output voltage (2 V/div.).  
Bottom trace: input voltage (50 V/div.).  
Time scale: (5 ms/div.).

#### Shut-down

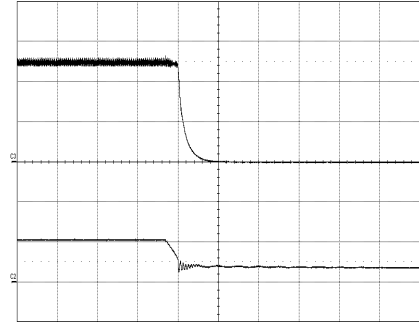

Shut-down enabled by disconnecting  $V_i$  at:  
 $T_{ref} = +25^\circ\text{C}$ ,  $V_i = 53\text{ V}$ ,  
 $I_O = 25\text{ A}$  resistive load.

Top trace: output voltage (2 V/div.).  
Bottom trace: input voltage (50 V/div.).  
Time scale: (0.2 ms/div.).

#### Output Ripple & Noise

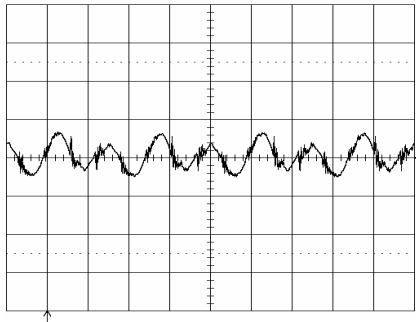

Output voltage ripple at:  
 $T_{ref} = +25^\circ\text{C}$ ,  $V_i = 53\text{ V}$ ,  
 $I_O = 25\text{ A}$  resistive load.

Trace: output voltage (20 mV/div.).  
Time scale: (2  $\mu\text{s}$ /div.).

#### Output Load Transient Response

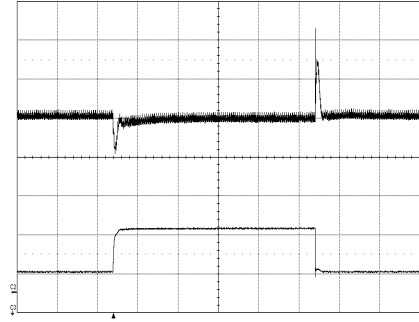

Output voltage response to load current step-change (6.25-18.75-6.25 A) at:  
 $T_{ref} = +25^\circ\text{C}$ ,  $V_i = 53\text{ V}$ .

Top trace: output voltage (200 mV/div.).  
Bottom trace: load current (10 A/div.).  
Time scale: (0.1 ms/div.).

### Output Voltage Adjust (see operating information)

#### Passive adjust

The resistor value for an adjusted output voltage is calculated by using the following equations:

Output Voltage Adjust Upwards, Increase:

$$R_{adj} = \left( \frac{5.11 \times 2.5(100 + \Delta\%)}{1.225 \times \Delta\%} - \frac{511}{\Delta\%} - 10.22 \right) \text{ k}\Omega$$

Example: Increase 10%  $\Rightarrow V_{out} = 2.75\text{ Vdc}$

$$\left( \frac{5.11 \times 2.5(100 + 10)}{1.225 \times 10} - \frac{511}{10} - 10.22 \right) \text{ k}\Omega = 53.39 \text{ k}\Omega$$

Output Voltage Adjust Downwards, Decrease:

$$R_{adj} = 5.11 \left( \frac{100}{\Delta\%} - 2 \right) \text{ k}\Omega$$

Example: Decrease 20%  $\Rightarrow V_{out} = 2.00\text{ Vdc}$

$$5.11 \left( \frac{100}{20} - 2 \right) \text{ k}\Omega = 15.33 \text{ k}\Omega$$

PKB 4000 series  
 DC/DC converters, Input 36-75 V, Output 30 A/90 W

EN/LZT 146 394 R6A November 2017

© Flex

**PKB 4610 PINB**
**3.3 V/20 A Electrical Specification**
 $T_{ref} = -40$  to  $+90^{\circ}\text{C}$ ,  $V_I = 36$  to  $75$  V, sense pins connected to output pins unless otherwise specified under Conditions.

 Typical values given at:  $T_{ref} = +25^{\circ}\text{C}$ ,  $V_I = 53$  V,  $I_O = \text{max } I_O$ , unless otherwise specified under Conditions.

 Additional  $C_{in} = 0$   $\mu\text{F}$  and  $C_{out} = 0$   $\mu\text{F}$ . See Operating Information section for selection of capacitor types.

Characteristics		Conditions	min	typ	max	Unit
$V_I$	Input voltage range		36		75	V
$V_{loff}$	Turn-off input voltage	Decreasing input voltage	30	30.8	32	V
$V_{lon}$	Turn-on input voltage	Increasing input voltage	33	34.0	35	V
$C_I$	Internal input capacitance			2.65		$\mu\text{F}$
$P_O$	Output power	Output voltage initial setting	0		66	W
$\eta$	Efficiency	50 % of max $I_O$		91.3		%
		max $I_O$		90.5		
		50 % of max $I_O$ , $V_I = 48$ V		91.6		
		max $I_O$ , $V_I = 48$ V		90.5		
$P_d$	Power Dissipation	max $I_O$		6.9	9.2	W
$P_{ii}$	Input idling power	$I_O = 0$ A, $V_I = 53$ V		1.6		W
$P_{RC}$	Input standby power	$V_I = 53$ V (turned off with RC)		0.13		W
$f_s$	Switching frequency	0-100 % of max $I_O$		164		kHz

$V_{Oi}$	Output voltage initial setting and accuracy	$T_{ref} = +25^{\circ}\text{C}$ , $V_I = 53$ V, $I_O = 25$ A	3.23	3.30	3.37	V
$V_O$	Output adjust range	See operating information	2.64		3.63	V
	Output voltage tolerance band	10-100 % of max $I_O$	3.20		3.40	V
	Idling voltage	$I_O = 0$ A	3.20		3.40	V
	Line regulation	max $I_O$		0.2	10	mV
	Load regulation	$V_I = 53$ V, 0-100 % of max $I_O$		0.4	10	mV
$V_{tr}$	Load transient voltage deviation	$V_I = 53$ V, Load step 25-75-25 % of max $I_O$ , $di/dt = 1$ A/ $\mu\text{s}$		$\pm 320$	$\pm 500$	mV
$t_{tr}$	Load transient recovery time			32	50	$\mu\text{s}$
$t_r$	Ramp-up time (from 10-90 % of $V_{Oi}$ )	10-100 % of max $I_O$	2	8	30	ms
$t_s$	Start-up time (from $V_I$ connection to 90 % of $V_{Oi}$ )		7	12	60	ms
$t_f$	$V_I$ shut-down fall time (from $V_I$ off to 10 % of $V_O$ )	max $I_O$		0.08		ms
		$I_O = 0$ A		5.2		s
$t_{RC}$	RC start-up time	max $I_O$		12		ms
	RC shut-down fall time (from RC off to 10 % of $V_O$ )	max $I_O$		0.06		ms
		$I_O = 0$ A		5.4		s
$I_O$	Output current		0		20	A
$I_{lim}$	Current limit threshold	$T_{ref} < \text{max } T_{ref}$	22	25	31	A
$I_{sc}$	Short circuit current	$T_{ref} = 25^{\circ}\text{C}$ , see Note 1		29	33	A
$V_{Oac}$	Output ripple & noise	See ripple & noise section, max $I_O$ , $V_{Oi}$		43	80	mVp-p
OVP	Over voltage protection	$T_{ref} = +25^{\circ}\text{C}$ , $V_I = 53$ V, 0-100 % of max $I_O$	3.7	4.1	4.7	V

Note 1: See Operating Information section.

PKB 4000 series  
DC/DC converters, Input 36-75 V, Output 30 A/90 W

EN/LZT 146 394 R6A November 2017

© Flex

### 3.3 V/20A Typical Characteristics

PKB 4610 PINB

#### Efficiency

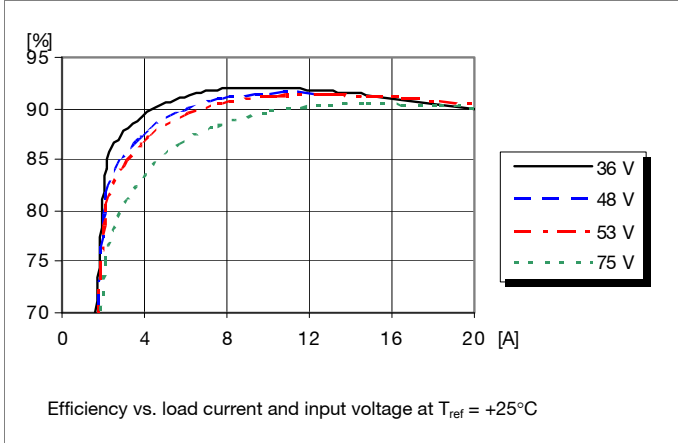

#### Power Dissipation

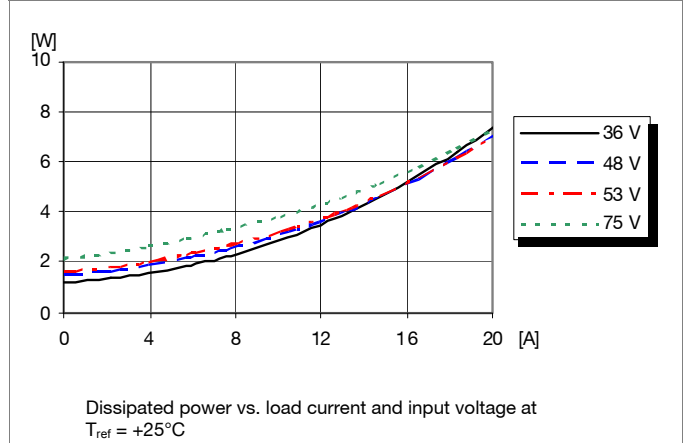

#### Output Current Derating

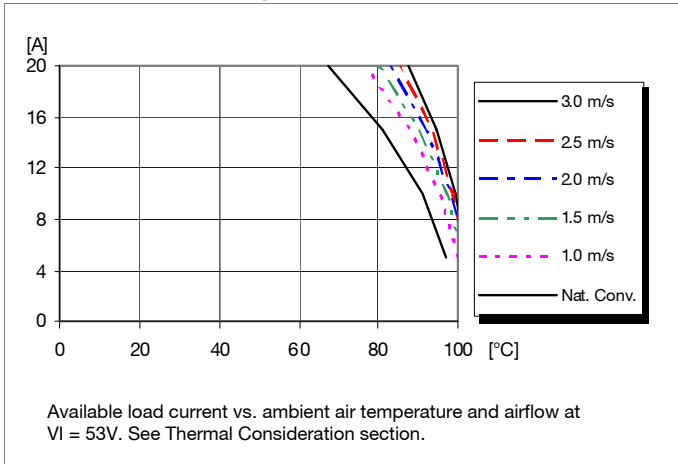

#### Thermal Resistance

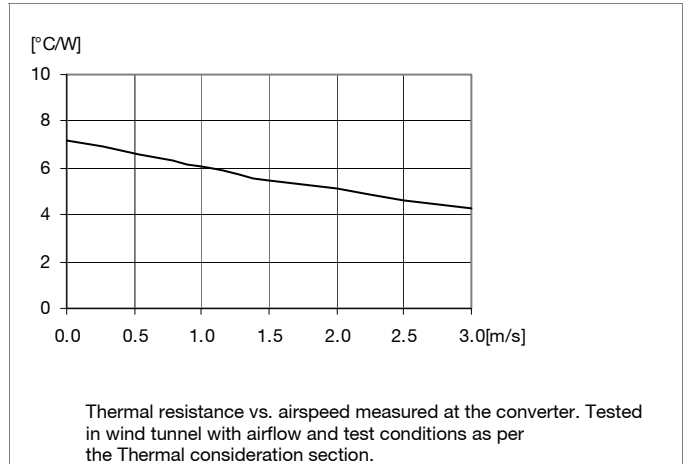

#### Output Characteristics

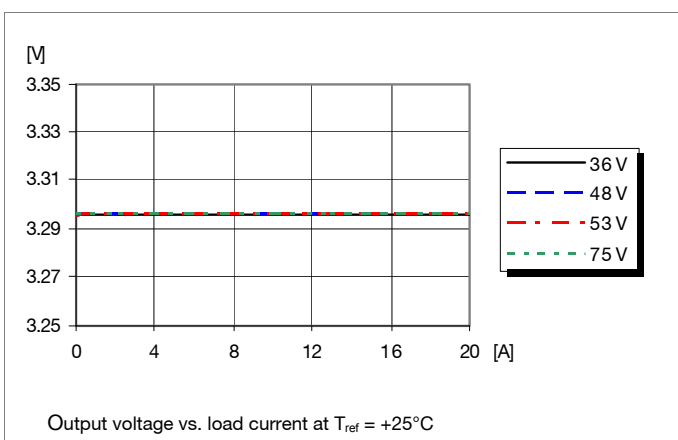

#### Current Limit Characteristics

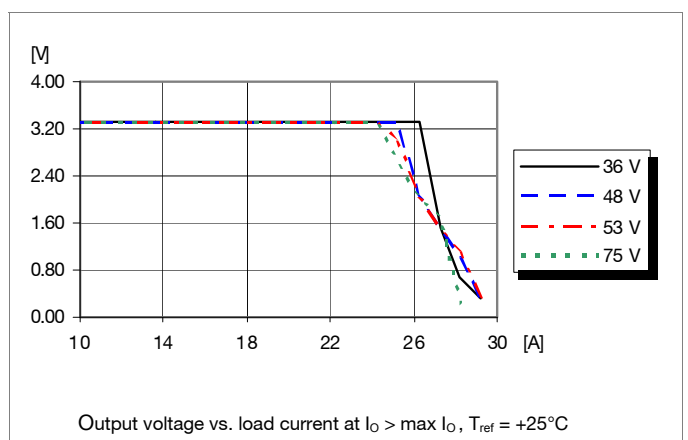

PKB 4000 series  
DC/DC converters, Input 36-75 V, Output 30 A/90 W

EN/LZT 146 394 R6A November 2017

© Flex

### 3.3 V/20 A Typical Characteristics

PKB 4610 PINB

#### Start-up

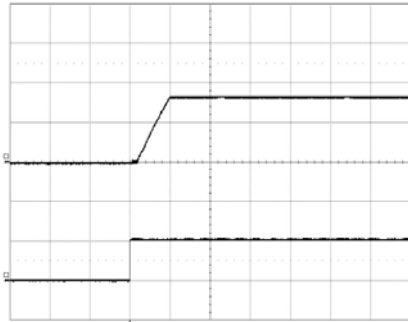

Start-up enabled by connecting  $V_i$  at:  
 $T_{PI} = +25^\circ\text{C}$ ,  $V_i = 53\text{ V}$ ,  
 $I_o = 20\text{ A}$  resistive load.

Top trace: output voltage (2 V/div.).  
Bottom trace: input voltage (50 V/div.).  
Time scale: (10 ms/div.).

#### Shut-down

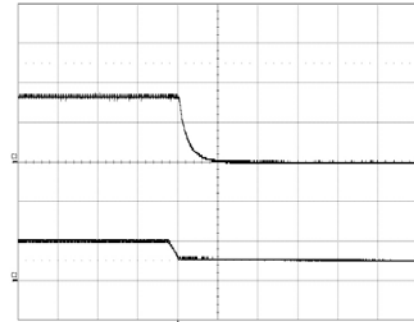

Shut-down enabled by disconnecting  $V_i$  at:  
 $T_{PI} = +25^\circ\text{C}$ ,  $V_i = 53\text{ V}$ ,  
 $I_o = 20\text{ A}$  resistive load.

Top trace: output voltage (2 V/div.).  
Bottom trace: input voltage (50 V/div.).  
Time scale: (0.1 ms/div.).

#### Output Ripple & Noise

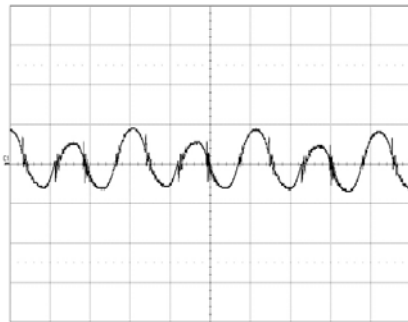

Output voltage ripple at:  
 $T_{PI} = +25^\circ\text{C}$ ,  $V_i = 53\text{ V}$ ,  
 $I_o = 20\text{ A}$  resistive load.

Trace: output voltage (20 mV/div.).  
Time scale: (2  $\mu\text{s}$ /div.).

#### Output Load Transient Response

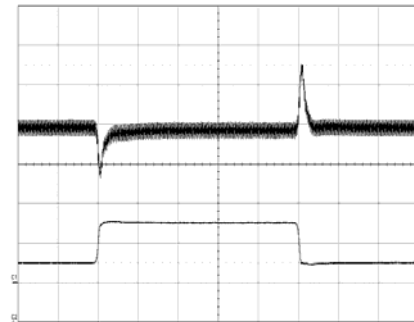

Output voltage response to load current step-  
change (5-15 A) at:  
 $T_{PI} = +25^\circ\text{C}$ ,  $V_i = 53\text{ V}$ .

Top trace: output voltage (200 mV/div.).  
Bottom trace: load current (10 A/div.).  
Time scale: (0.1 ms/div.).

#### Output Voltage Adjust (see operating information)

##### Passive adjust

The resistor value for an adjusted output voltage is calculated by using the following equations:

Output Voltage Adjust Upwards, Increase:  
$$R_{adj} = \left( \frac{5.11 \times 3.30(100 + \Delta\%)}{1.225 \times \Delta\%} - \frac{511}{\Delta\%} - 10.22 \right) \text{ k}\Omega$$

Example: Increase 4%  $\Rightarrow V_{out} = 3.432\text{ Vdc}$   
$$\left( \frac{5.11 \times 3.30(100 + 4)}{1.225 \times 4} - \frac{511}{4} - 10.22 \right) \text{ k}\Omega = 220\text{ k}\Omega$$

Output Voltage Adjust Downwards, Decrease:

$$R_{adj} = 5.11 \times \left( \frac{100}{\Delta\%} - 2 \right) \text{ k}\Omega$$

Example: Decrease 4%  $\Rightarrow V_{out} = 3.168\text{ Vdc}$

$$5.11 \times \left( \frac{100}{4} - 2 \right) \text{ k}\Omega = 117.5\text{ k}\Omega$$

##### Active adjust

The output voltage may be adjusted using a {current/voltage} applied to the Vadj pin. This {current/voltage} is calculated by using the following equations:

$$V_{adj} = \left( 1.225 + 2.45 \times \frac{V_{desired} - 3.3}{3.3} \right) \text{ V}$$

Example: Upwards  $\Rightarrow 3.40\text{ V}$

$$\left( 1.225 + 2.45 \times \frac{3.40 - 3.30}{3.3} \right) \text{ V} = 1.2992\text{ V}$$

Example: Downwards  $\Rightarrow 3.20\text{ V}$

$$\left( 1.225 + 2.45 \times \frac{3.20 - 3.30}{3.3} \right) \text{ V} = 1.1508\text{ V}$$

PKB 4000 series DC/DC converters, Input 36-75 V, Output 30 A/90 W	EN/LZT 146 394 R6A November 2017
	© Flex

### 3.3 V/25 A Electrical Specification

### PKB 4810 PINB

$T_{ref} = -40$  to  $+90^{\circ}\text{C}$ ,  $V_I = 36$  to  $75$  V, sense pins connected to output pins unless otherwise specified under Conditions.

Typical values given at:  $T_{ref} = +25^{\circ}\text{C}$ ,  $V_I = 53$  V,  $I_O = \text{max } I_O$ , unless otherwise specified under Conditions.

Additional  $C_{in} = 0$   $\mu\text{F}$  and  $C_{out} = 0$   $\mu\text{F}$ . See Operating Information section for selection of capacitor types.

Characteristics		Conditions	min	typ	max	Unit
$V_I$	Input voltage range		36		75	V
$V_{loff}$	Turn-off input voltage	Decreasing input voltage	30	30.9	32	V
$V_{lon}$	Turn-on input voltage	Increasing input voltage	33	34.1	35	V
$C_I$	Internal input capacitance			3.35		$\mu\text{F}$
$P_O$	Output power	Output voltage initial setting	0		82.5	W
$\eta$	Efficiency	50 % of $\text{max } I_O$		91.5		%
		$\text{max } I_O$		89.6		
		50 % of $\text{max } I_O$ , $V_I = 48$ V		91.7		
		$\text{max } I_O$ , $V_I = 48$ V		89.4		
$P_d$	Power Dissipation	$\text{max } I_O$		9.6	12	W
$P_{li}$	Input idling power	$I_O = 0$ A, $V_I = 53$ V		1.6		W
$P_{RC}$	Input standby power	$V_I = 53$ V (turned off with RC)		0.12		W
$f_s$	Switching frequency	0-100 % of $\text{max } I_O$		166		kHz

$V_{Oi}$	Output voltage initial setting and accuracy	$T_{ref} = +25^{\circ}\text{C}$ , $V_I = 53$ V, $I_O = 25$ A	3.23	3.30	3.37	V
$V_O$	Output adjust range	See operating information	2.64		3.63	V
	Output voltage tolerance band	10-100 % of $\text{max } I_O$	3.20		3.40	V
	Idling voltage	$I_O = 0$ A	3.20		3.40	V
	Line regulation	$\text{max } I_O$		0.3	10	mV
	Load regulation	$V_I = 53$ V, 0-100 % of $\text{max } I_O$		3	10	mV
$V_{tr}$	Load transient voltage deviation	$V_I = 53$ V, Load step 25-75-25 % of $\text{max } I_O$ , $di/dt = 1$ A/ $\mu\text{s}$		$\pm 265$	$\pm 500$	mV
$t_{tr}$	Load transient recovery time			35	130	$\mu\text{s}$
$t_r$	Ramp-up time (from 10-90 % of $V_O$ )	10-100 % of $\text{max } I_O$	2	9	30	ms
$t_s$	Start-up time (from $V_I$ connection to 90 % of $V_O$ )		7	12	60	ms
$t_f$	$V_I$ shut-down fall time (from $V_I$ off to 10 % of $V_O$ )	$\text{max } I_O$		0.06		ms
		$I_O = 0$ A		6.2		s
$t_{RC}$	RC start-up time	$\text{max } I_O$		12		ms
	RC shut-down fall time (from RC off to 10 % of $V_O$ )	$\text{max } I_O$		0.05		ms
		$I_O = 0$ A		6.6		s
$I_O$	Output current		0		25	A
$I_{lim}$	Current limit threshold	$T_{ref} < \text{max } T_{ref}$	26	31	36	A
$I_{sc}$	Short circuit current	$T_{ref} = 25^{\circ}\text{C}$ , see Note 1		35	39	A
$V_{Oac}$	Output ripple & noise	See ripple & noise section, $\text{max } I_O$ , $V_{Oi}$		40	80	mVp-p
OVP	Over voltage protection	$T_{ref} = +25^{\circ}\text{C}$ , $V_I = 53$ V, 0-100 % of $\text{max } I_O$	3.7	4.1	4.7	V

Note 1: See Operating Information section.

PKB 4000 series  
DC/DC converters, Input 36-75 V, Output 30 A/90 W

EN/LZT 146 394 R6A November 2017

© Flex

### 3.3 V/25A Typical Characteristics

### PKB 4810 PINB

#### Efficiency

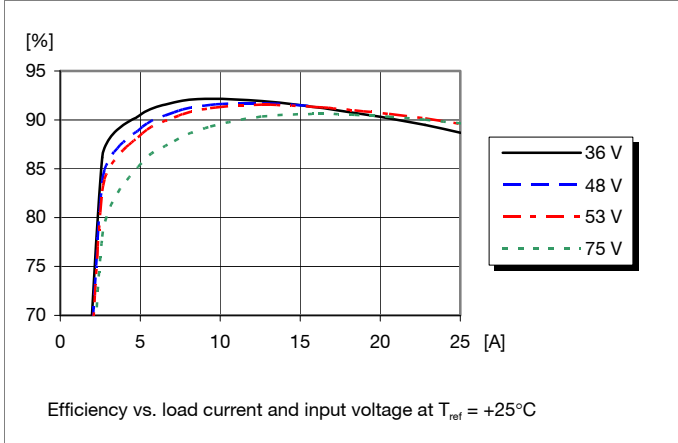

#### Power Dissipation

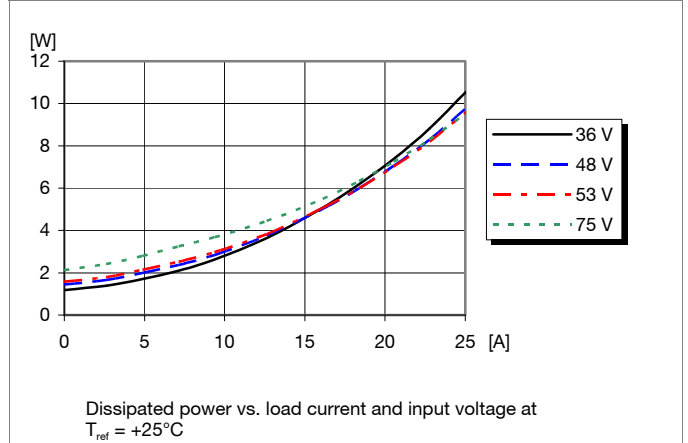

#### Output Current Derating

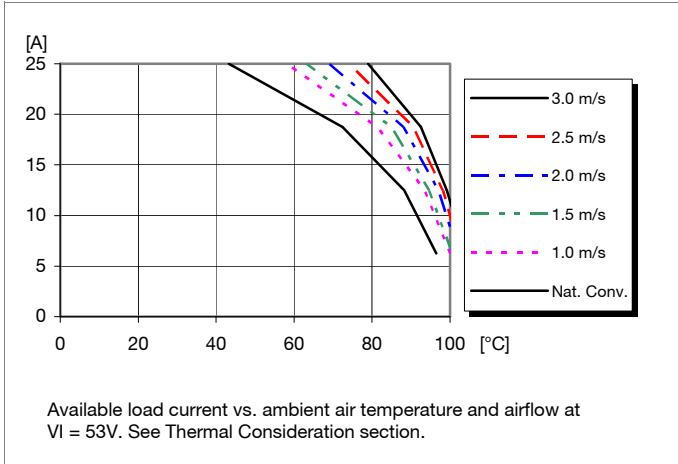

#### Thermal Resistance

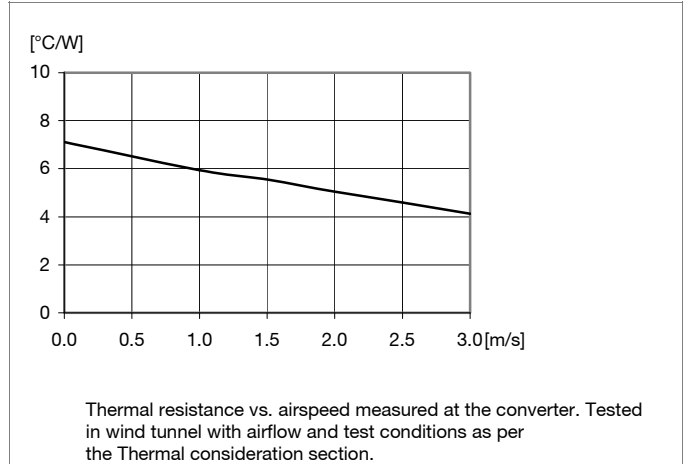

#### Output Characteristics

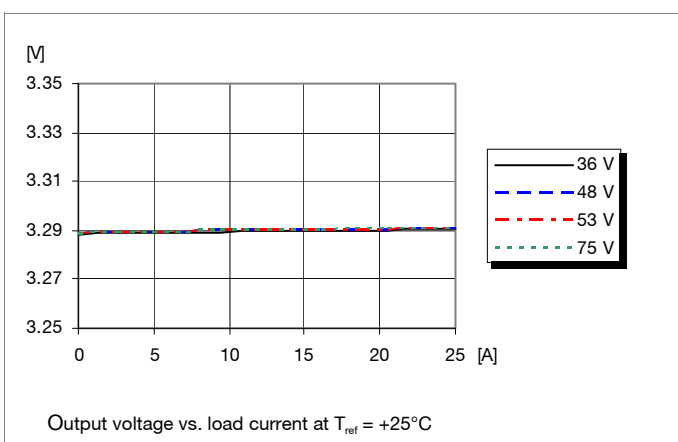

#### Current Limit Characteristics

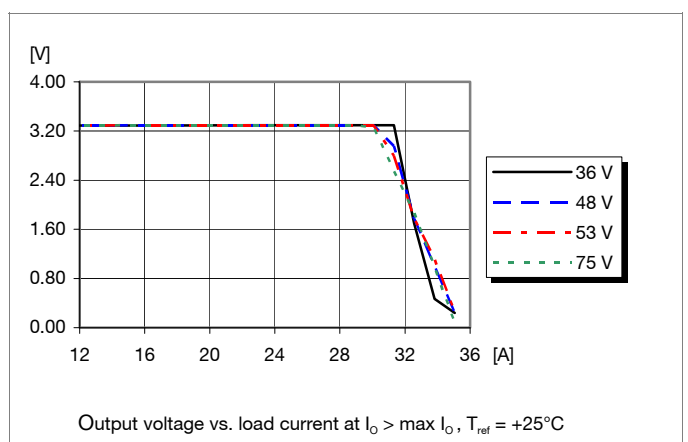



PKB 4000 series  
DC/DC converters, Input 36-75 V, Output 30 A/90 W

EN/LZT 146 394 R6A November 2017

© Flex

### 3.3 V/25 A Typical Characteristics

PKB 4810 PINB

#### Start-up

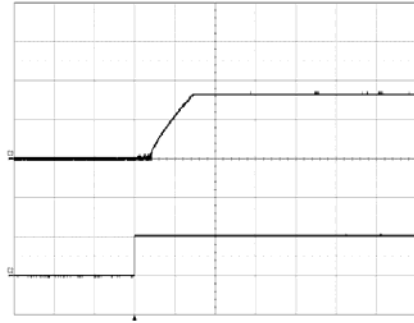

Start-up enabled by connecting  $V_i$  at:  
 $T_{PI} = +25^\circ\text{C}$ ,  $V_i = 53\text{ V}$ ,  
 $I_o = 25\text{ A}$  resistive load.

Top trace: output voltage (2 V/div.),  
Bottom trace: input voltage (50 V/div.).  
Time scale: (10 ms/div.).

#### Shut-down

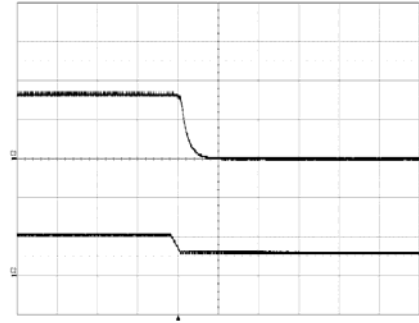

Shut-down enabled by disconnecting  $V_i$  at:  
 $T_{PI} = +25^\circ\text{C}$ ,  $V_i = 53\text{ V}$ ,  
 $I_o = 25\text{ A}$  resistive load.

Top trace: output voltage (2 V/div.),  
Bottom trace: input voltage (50 V/div.).  
Time scale: (0.1 ms/div.).

#### Output Ripple & Noise

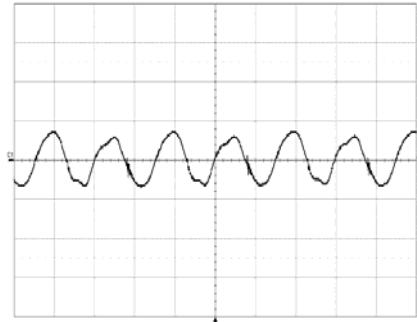

Output voltage ripple at:  
 $T_{PI} = +25^\circ\text{C}$ ,  $V_i = 53\text{ V}$ ,  
 $I_o = 25\text{ A}$  resistive load.

Trace: output voltage (20 mV/div.).  
Time scale: (2 μs/div.).

#### Output Load Transient Response



Output voltage response to load current step-change (6.25-18.75-6.25 A) at:  
 $T_{PI} = +25^\circ\text{C}$ ,  $V_i = 53\text{ V}$ .

Top trace: output voltage (200 mV/div.).  
Bottom trace: load current (10 A/div.).  
Time scale: (0.1 ms/div.).

#### Output Voltage Adjust (see operating information)

##### Passive adjust

The resistor value for an adjusted output voltage is calculated by using the following equations:

Output Voltage Adjust Upwards, Increase:

$$R_{adj} = \left( \frac{5.11 \times 3.30(100 + \Delta\%)}{1.225 \times \Delta\%} - \frac{511}{\Delta\%} - 10.22 \right) \text{ k}\Omega$$

Example: Increase 4% =>  $V_{out} = 3.432\text{ Vdc}$

$$\left( \frac{5.11 \times 3.30(100 + 4)}{1.225 \times 4} - \frac{511}{4} - 10.22 \right) \text{ k}\Omega = 220 \text{ k}\Omega$$

Output Voltage Adjust Downwards, Decrease:

$$R_{adj} = 5.11 \times \left( \frac{100}{\Delta\%} - 2 \right) \text{ k}\Omega$$

Example: Decrease 4% =>  $V_{out} = 3.168\text{ Vdc}$

$$5.11 \times \left( \frac{100}{4} - 2 \right) \text{ k}\Omega = 117.5\text{ k}\Omega$$

##### Active adjust

The output voltage may be adjusted using a current/voltage applied to the  $V_{adj}$  pin. This current/voltage is calculated by using the following equations:

$$V_{adj} = \left( 1.225 + 2.45 \times \frac{V_{desired} - 3.30}{3.30} \right) \text{ V}$$

Example: Upwards => 3.40 V

$$\left( 1.225 + 2.45 \times \frac{3.40 - 3.30}{3.30} \right) \text{ V} = 1.2992 \text{ V}$$

Example: Downwards => 3.20 V

$$\left( 1.225 + 2.45 \times \frac{3.20 - 3.30}{3.30} \right) \text{ V} = 1.1508 \text{ V}$$

PKB 4000 series  
 DC/DC converters, Input 36-75 V, Output 30 A/90 W

EN/LZT 146 394 R6A November 2017

© Flex

**5.0 V/15 A Electrical Specification**
**PKB4711 PINB**
 $T_{ref} = -40$  to  $+90^{\circ}\text{C}$ ,  $V_I = 36$  to  $75$  V, sense pins connected to output pins unless otherwise specified under Conditions.

 Typical values given at:  $T_{ref} = +25^{\circ}\text{C}$ ,  $V_I = 53$  V,  $I_O$ , unless otherwise specified under Conditions.

 Additional  $C_{in} = 0\mu\text{F}$  and  $C_{out} = 0\mu\text{F}$ . See Operating Information section for selection of capacitor types.

Characteristics		Conditions	min	typ	max	Unit
$V_I$	Input voltage range		36		75	V
$V_{loff}$	Turn-off input voltage	Decreasing input voltage	29.9	31.0	32.2	V
$V_{lon}$	Turn-on input voltage	Increasing input voltage	33.2	34.2	35.0	V
$C_I$	Internal input capacitance			2.65		$\mu\text{F}$
$P_O$	Output power	Output voltage initial setting	0		75	W
$\eta$	Efficiency	50 % of max $I_O$		90.5		%
		max $I_O$		89.9		
		50 % of max $I_O$ , $V_I = 48$ V		90.9		
		max $I_O$ , $V_I = 48$ V		89.9		
$P_d$	Power Dissipation	max $I_O$		8.5	10.9	W
$P_{li}$	Input idling power	$I_O = 0$ A, $V_I = 53$ V		2.2		W
$P_{RC}$	Input standby power	$V_I = 53$ V (turned off with RC)		0.125		W
$f_s$	Switching frequency	0-100 % of max $I_O$		198		kHz

$V_{Oi}$	Output voltage initial setting and accuracy	$T_{ref} = +25^{\circ}\text{C}$ , $V_I = 53$ V, $I_O = 15$ A	4.90	5.0	5.10	V
$V_O$	Output adjust range	See operating information	4.00		5.50	V
	Output voltage tolerance band	10-100 % of max $I_O$	4.97		5.14	V
	Idling voltage	$I_O = 0$ A	4.97		5.14	V
	Line regulation	max $I_O$		1	3.1	mV
	Load regulation	$V_I = 53$ V, 0-100 % of max $I_O$		1	2.7	mV
$V_{tr}$	Load transient voltage deviation	$V_I = 53$ V, Load step 25-75-25 % of max $I_O$ , $di/dt = 1$ A/ $\mu\text{s}$		$\pm 300$	490	mV
$t_{tr}$	Load transient recovery time			25	50	$\mu\text{s}$
$t_r$	Ramp-up time (from 10-90 % of $V_O$ )	10-100 % of max $I_O$	7	10	12	ms
$t_s$	Start-up time (from $V_I$ connection to 90 % of $V_O$ )		10	12	14	ms
$t_f$	$V_I$ shut-down fall time (from $V_I$ off to 10 % of $V_O$ )	max $I_O$	0.12	0.14	0.16	ms
		$I_O = 0$ A	4.2	4.5	5.2	s
$t_{RC}$	RC start-up time	max $I_O$		10		ms
	RC shut-down fall time (from RC off to 10 % of $V_O$ )	max $I_O$		0.13		ms
		$I_O = 0$ A		4.5		s
$I_O$	Output current		0		15	A
$I_{lim}$	Current limit threshold	$T_{ref} < \max T_{ref}$		19		A
$I_{sc}$	Short circuit current	$T_{ref} = 25^{\circ}\text{C}$ ,		22	25	A
$V_{Oac}$	Output ripple & noise	See ripple & noise section, max $I_O$ , $V_{Oi}$		50	80	mVp-p
OVP	Over voltage protection	$T_{ref} = +25^{\circ}\text{C}$ , $V_I = 53$ V, 0-100 % of max $I_O$	6		7	V

PKB 4000 series  
DC/DC converters, Input 36-75 V, Output 30 A/90 W

EN/LZT 146 394 R6A November 2017

© Flex

## 5.0 V/15 A Typical Characteristics

PKB4711 PINB

### Efficiency

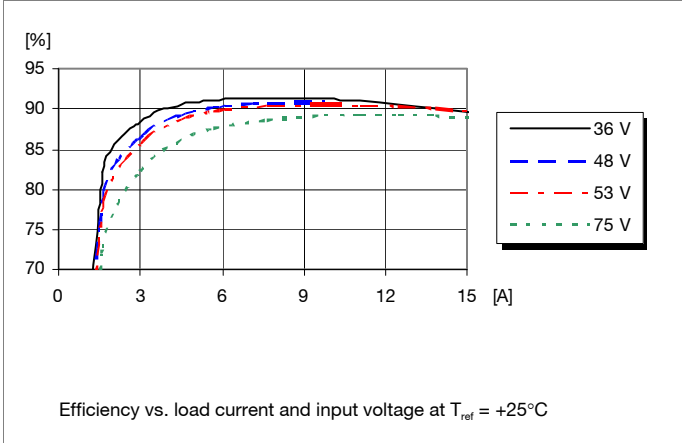

### Power Dissipation

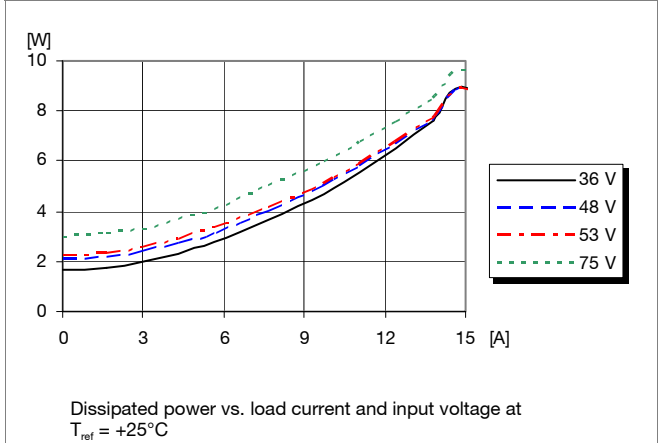

### Output Current Derating

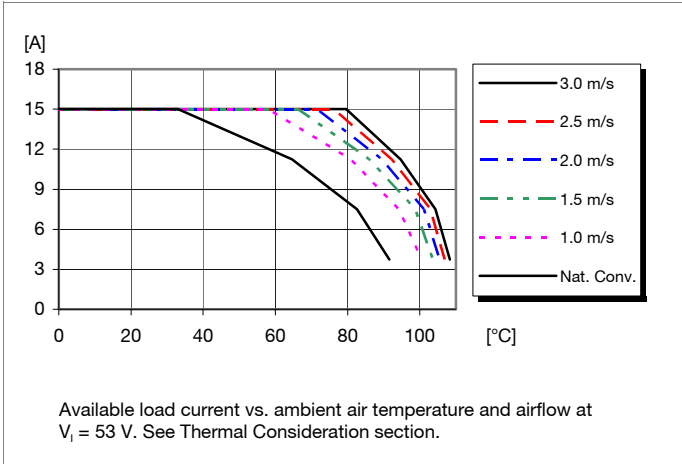

### Thermal Resistance

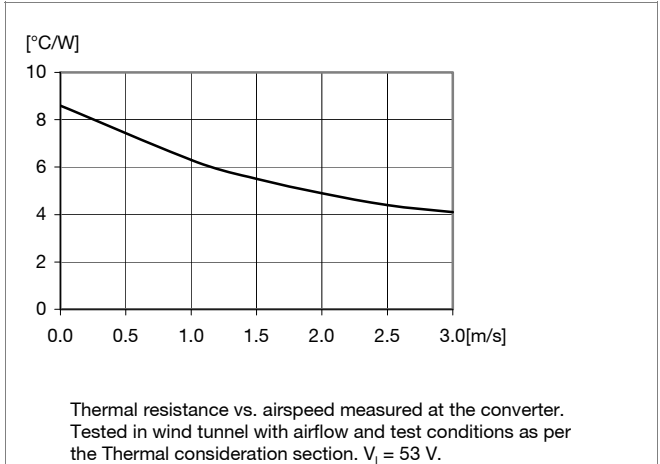

### Output Characteristics

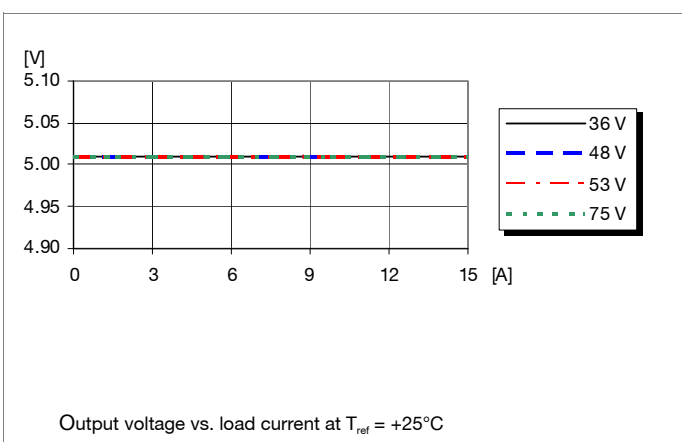

### Current Limit Characteristics

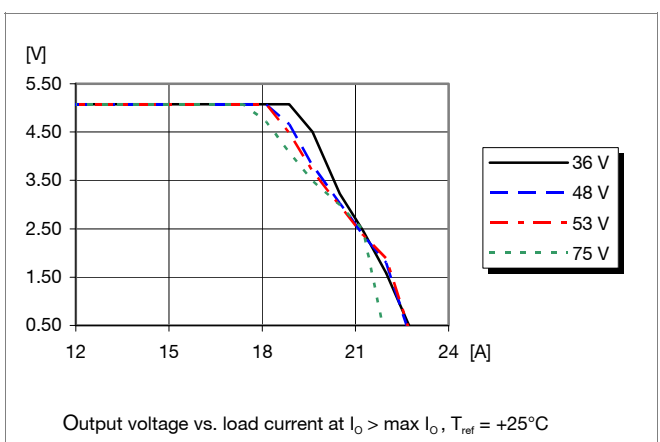

PKB 4000 series  
DC/DC converters, Input 36-75 V, Output 30 A/90 W

EN/LZT 146 394 R6A November 2017

© Flex

### 5.0 V/15 A Typical Characteristics

PKB4711 PINB

#### Start-up

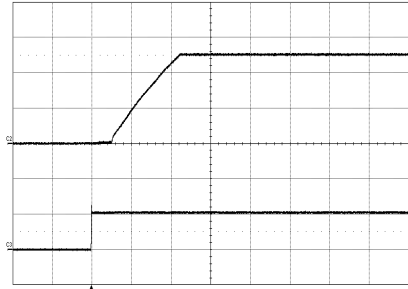

Start-up enabled by connecting  $V_i$  at:  
 $T_{ref} = +25^\circ\text{C}$ ,  $V_i = 53\text{ V}$ ,  
 $I_o = 15\text{ A}$  resistive load.

Top trace: output voltage (2 V/div.).  
Bottom trace: input voltage (50 V/div.).  
Time scale: (5 ms/div.).

#### Shut-down

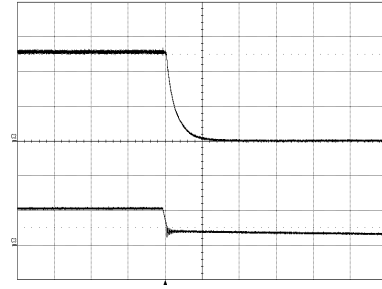

Shut-down enabled by disconnecting  $V_i$  at:  
 $T_{ref} = +25^\circ\text{C}$ ,  $V_i = 53\text{ V}$ ,  
 $I_o = 15\text{ A}$  resistive load.

Top trace: output voltage (2 V/div.).  
Bottom trace: input voltage (50 V/div.).  
Time scale: (0.2 ms/div.).

#### Output Ripple & Noise

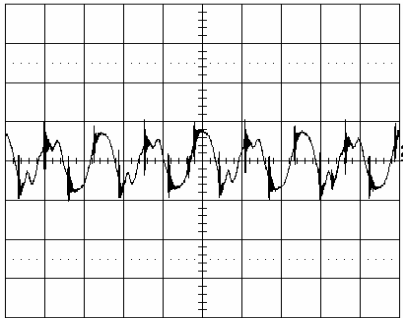

Output voltage ripple at:  
 $T_{ref} = +25^\circ\text{C}$ ,  $V_i = 53\text{ V}$ ,  
 $I_o = 15\text{ A}$  resistive load.

Trace: output voltage (20 mV/div.).  
Time scale: (2  $\mu\text{s}$ /div.).

#### Output Load Transient Response

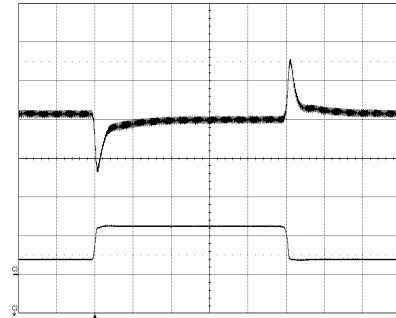

Output voltage response to load current step-  
change (3.75-11.25-3.75 A) at:  
 $T_{ref} = +25^\circ\text{C}$ ,  $V_i = 53\text{ V}$ .

Top trace: output voltage (200 mV/div.).  
Bottom trace: load current (10 A/div.).  
Time scale: (0.1 ms/div.).

#### Output Voltage Adjust (see operating information)

##### Passive adjust

The resistor value for an adjusted output voltage is calculated by using the following equations:

Output Voltage Adjust Upwards, Increase:

$$R_{adj} = 5.11 \times \left( \frac{V_o \cdot (100 + \Delta\%) - 100 + 2 \cdot \Delta\%}{1.225 \cdot \Delta\%} \right) \text{ k}\Omega$$

Example: Increase 4% =>  $V_{out} = 5.2\text{ Vdc}$

$$5.11 \times \left( \frac{5.0(100 + 4) - 100 + 2 \times 4}{1.225 \times 4} \right) \text{ k}\Omega = 404.3 \text{ k}\Omega$$

Output Voltage Adjust Downwards, Decrease:

$$R_{adj} = 5.11 \times \left( \frac{100}{\Delta\%} - 2 \right) \text{ k}\Omega$$

Example: Decrease 4% =>  $V_{out} = 4.8\text{ Vdc}$

$$5.11 \times \left( \frac{100}{4} - 2 \right) \text{ k}\Omega = 117.5 \text{ k}\Omega$$

##### Active adjust

The output voltage may be adjusted using a {current/voltage} applied to the  $V_{adj}$  pin. This {current/voltage} is calculated by using the following equations:

$$V_{adj} = \left( 1.225 + 2.45 \times \frac{V_{desired} - 5}{5} \right) \text{ V}$$

Example: Upwards => 5.1 V

$$\left( 1.225 + 2.45 \times \frac{5.1 - 5}{5} \right) \text{ V} = 1.274 \text{ V}$$

Example: Downwards => 4.9 V

$$\left( 1.225 + 2.45 \times \frac{4.9 - 5}{5} \right) \text{ V} = 1.176 \text{ V}$$

PKB 4000 series  
DC/DC converters, Input 36-75 V, Output 30 A/90 W

EN/LZT 146 394 R6A November 2017

© Flex

### 12 V/6 A Electrical Specification

### PKB 4713 PINB

$T_{ref} = -40$  to  $+90^{\circ}\text{C}$ ,  $V_I = 36$  to  $75$  V, sense pins connected to output pins unless otherwise specified under Conditions.

Typical values given at:  $T_{ref} = +25^{\circ}\text{C}$ ,  $V_I = 53$  V,  $I_O = \text{max } I_O$ , unless otherwise specified under Conditions.

Additional  $C_{in} = 0$   $\mu\text{F}$  and  $C_{out} = 0$   $\mu\text{F}$ . See Operating Information section for selection of capacitor types.

Characteristics		Conditions	min	typ	max	Unit
$V_I$	Input voltage range		36		75	V
$V_{loff}$	Turn-off input voltage	Decreasing input voltage	30	31.1	32	V
$V_{lon}$	Turn-on input voltage	Increasing input voltage	33	34.1	35	V
$C_I$	Internal input capacitance			3.35		$\mu\text{F}$
$P_O$	Output power	Output voltage initial setting	0		72	W
$\eta$	Efficiency	50 % of max $I_O$		90.6		%
		max $I_O$		90.7		
		50 % of max $I_O$ , $V_I = 48$ V		91.1		
		max $I_O$ , $V_I = 48$ V		90.8		
$P_d$	Power Dissipation	max $I_O$		7.5	11	W
$P_{li}$	Input idling power	$I_O = 0$ A, $V_I = 53$ V		2.4		W
$P_{RC}$	Input standby power	$V_I = 53$ V (turned off with RC)		0.12		W
$f_s$	Switching frequency	0-100 % of max $I_O$		200		kHz

$V_{O1}$	Output voltage initial setting and accuracy	$T_{ref} = +25^{\circ}\text{C}$ , $V_I = 53$ V, $I_O = 6$ A	11.80	12.0	12.25	V
$V_O$	Output adjust range	See operating information	9.6		13.2	V
	Output voltage tolerance band	10-100 % of max $I_O$	11.75		12.30	V
	Idling voltage	$I_O = 0$ A	11.75		12.30	V
	Line regulation	max $I_O$		2	20	mV
	Load regulation	$V_I = 53$ V, 0-100 % of max $I_O$		1	10	mV
$V_{tr}$	Load transient voltage deviation	$V_I = 53$ V, Load step 25-75-25 % of max $I_O$ , $di/dt = 1$ A/ $\mu\text{s}$		$\pm 380$	$\pm 500$	mV
$t_{tr}$	Load transient recovery time			20	100	$\mu\text{s}$
$t_r$	Ramp-up time (from 10-90 % of $V_O$ )	10-100 % of max $I_O$	6	9.5	18	ms
$t_s$	Start-up time (from $V_I$ connection to 90 % of $V_O$ )		8	13	20	ms
$t_f$	$V_I$ shut-down fall time (from $V_I$ off to 10 % of $V_O$ )	max $I_O$		0.4		ms
		$I_O = 0$ A		2.1		s
$t_{RC}$	RC start-up time	max $I_O$		10.5		ms
	RC shut-down fall time (from RC off to 10 % of $V_O$ )	max $I_O$		0.4		ms
		$I_O = 0$ A		2.1		s
$I_O$	Output current		0		6	A
$I_{lim}$	Current limit threshold	$T_{ref} < \text{max } T_{ref}$	6.6	7.4	9	A
$I_{sc}$	Short circuit current	$T_{ref} = 25^{\circ}\text{C}$ , see Note 1		8.2	10	A
$V_{Oac}$	Output ripple & noise	See ripple & noise section, max $I_O$ , $V_{O1}$		70	100	mVp-p
OVP	Over voltage protection	$T_{ref} = +25^{\circ}\text{C}$ , $V_I = 53$ V, 0-100 % of max $I_O$	14	15	16	V

Note 1: See Operating Information section.

PKB 4000 series  
DC/DC converters, Input 36-75 V, Output 30 A/90 W

EN/LZT 146 394 R6A November 2017

© Flex

### 12 V/6 A Typical Characteristics

### PKB 4713 PINB

#### Efficiency

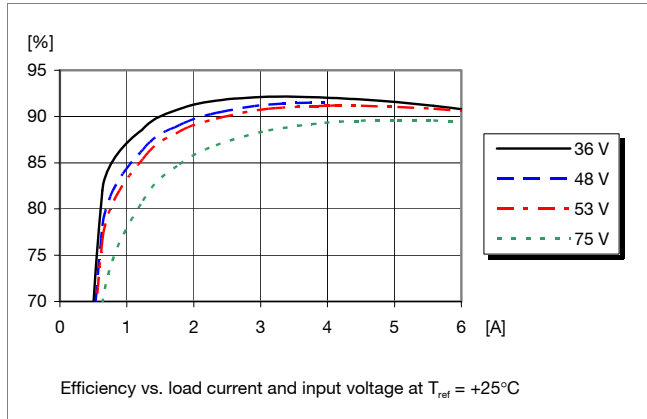

#### Power Dissipation

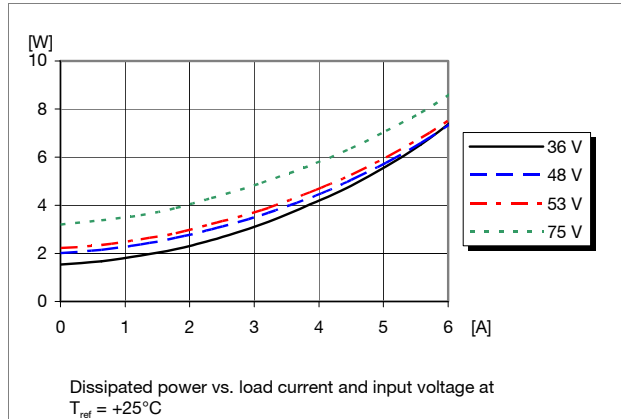

#### Output Current Derating

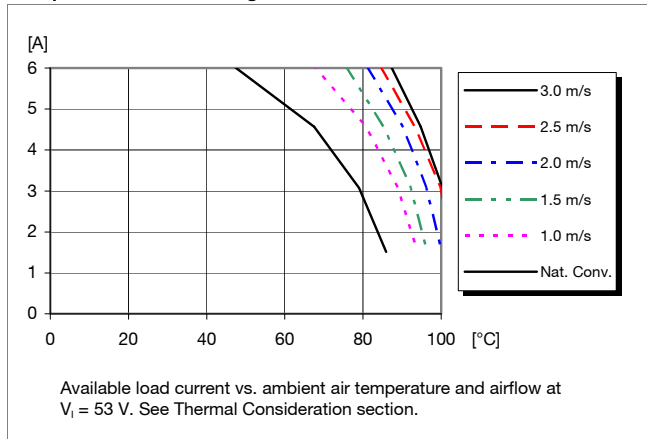

#### Thermal Resistance

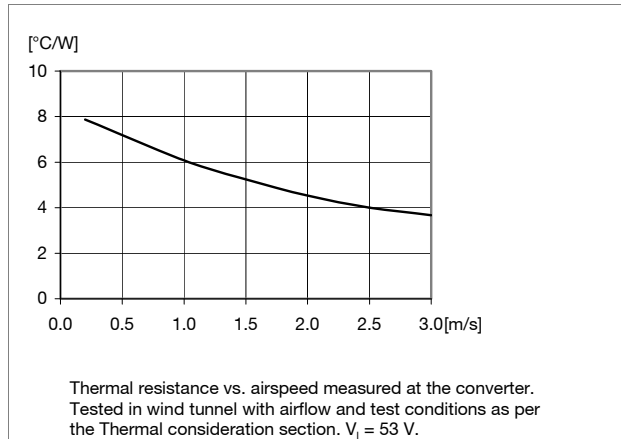

#### Output Characteristics

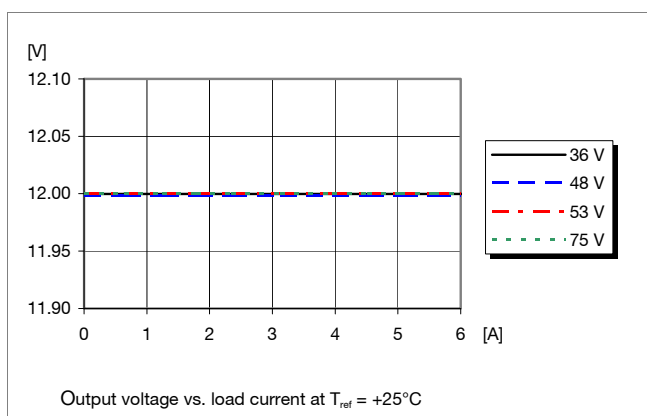

#### Current Limit Characteristics

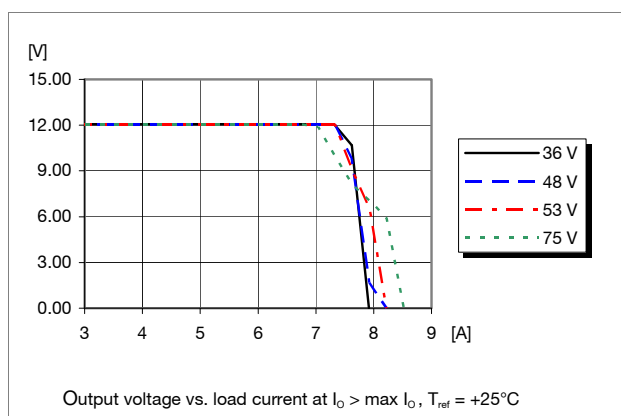

PKB 4000 series  
DC/DC converters, Input 36-75 V, Output 30 A/90 W

EN/LZT 146 394 R6A November 2017

© Flex

### 12 V/6 A Typical Characteristics

### PKB 4713 PINB

#### Start-up

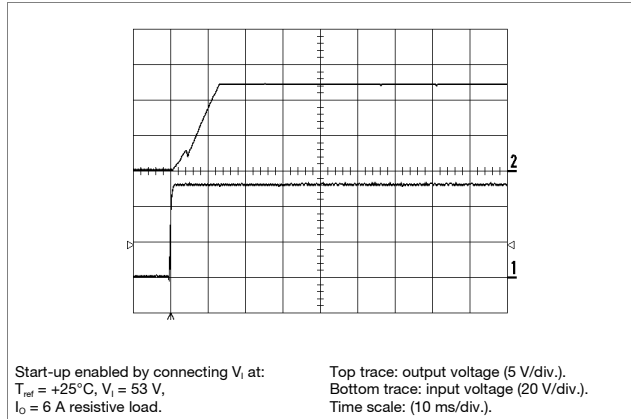

#### Shut-down

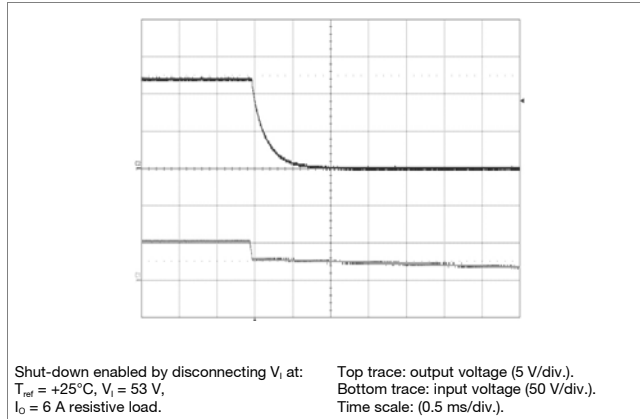

#### Output Ripple & Noise

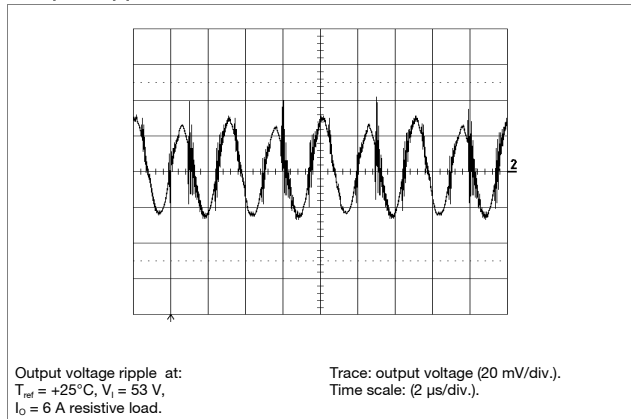

#### Output Load Transient Response

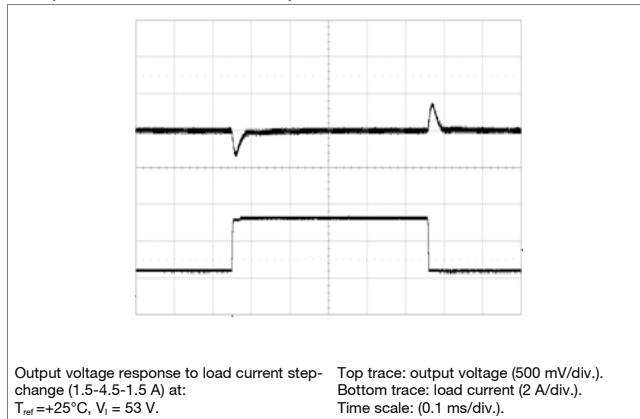

### Output Voltage Adjust (see operating information)

#### Passive adjust

The resistor value for an adjusted output voltage is calculated by using the following equations:

#### Output Voltage Adjust Upwards, Increase:

$$R_{adj} = 5.11 \left( \frac{12(100 + \Delta\%)}{1.225 \times \Delta\%} - \frac{(100 + 2\Delta\%)}{\Delta\%} \right) \text{ k}\Omega$$

Example: Increase 2% =>  $V_{out} = 12.24\text{ Vdc}$

$$R_{adj} = 5.11 \left( \frac{12(100 + 2)}{1.225 \times 2} - \frac{(100 + 2 \times 2)}{2} \right) \text{ k}\Omega = 2287.2 \text{ k}\Omega$$

#### Output Voltage Adjust Downwards, Decrease:

$$R_{adj} = 5.11 \times \left( \frac{100}{\Delta\%} - 2 \right) \text{ k}\Omega$$

Example: Decrease 4% =>  $V_{out} = 11.52\text{ Vdc}$

$$5.11 \times \left( \frac{100}{4} - 2 \right) \text{ k}\Omega = 117.5 \text{ k}\Omega$$

#### Active adjust

The output voltage may be adjusted using a {current/voltage} applied to the  $V_{adj}$  pin. This {current/voltage} is calculated by using the following equations:

$$V_{adj} = \left( 1.225 + 2.45 \times \frac{V_{desired} - 12}{12} \right) \text{ V}$$

Example: Upwards => 12.50 V

$$\left( 1.225 + 2.45 \times \frac{12.50 - 12}{12} \right) \text{ V} = 1.327 \text{ V}$$

Example: Downwards => 12.50 V

$$\left( 1.225 + 2.45 \times \frac{11.50 - 12}{12} \right) \text{ V} = 1.123 \text{ V}$$

PKB 4000 series  
 DC/DC converters, Input 36-75 V, Output 30 A/90 W

EN/LZT 146 394 R6A November 2017

© Flex

**12 V/7.5 A Electrical Specification**
**PKB 4913 PINB**
 $T_{ref} = -40$  to  $+90^{\circ}\text{C}$ ,  $V_I = 36$  to  $75$  V, sense pins connected to output pins unless otherwise specified under Conditions.

 Typical values given at:  $T_{ref} = +25^{\circ}\text{C}$ ,  $V_I = 53$  V,  $I_O = \text{max } I_O$ , unless otherwise specified under Conditions.

 Additional  $C_{in} = 0$   $\mu\text{F}$  and  $C_{out} = 0$   $\mu\text{F}$ . See Operating Information section for selection of capacitor types.

Characteristics		Conditions	min	typ	max	Unit
$V_I$	Input voltage range		36		75	V
$V_{loff}$	Turn-off input voltage	Decreasing input voltage	30	31.7	32	V
$V_{lon}$	Turn-on input voltage	Increasing input voltage	33	34.0	35	V
$C_I$	Internal input capacitance			3.35		$\mu\text{F}$
$P_O$	Output power	Output voltage initial setting	0		90	W
$\eta$	Efficiency	50 % of max $I_O$		90.5		%
		max $I_O$		89.4		
		50 % of max $I_O$ , $V_I = 48$ V		91.2		
		max $I_O$ , $V_I = 48$ V		89.5		
$P_d$	Power Dissipation	max $I_O$		10.8		W
$P_{li}$	Input idling power	$I_O = 0$ A, $V_I = 53$ V		2.4		W
$P_{RC}$	Input standby power	$V_I = 53$ V (turned off with RC)		0.1		W
$f_s$	Switching frequency	0-100 % of max $I_O$		200		kHz

$V_{Oi}$	Output voltage initial setting and accuracy	$T_{ref} = +25^{\circ}\text{C}$ , $V_I = 53$ V, $I_O = 6$ A	11.80	12	12.25	V
$V_O$	Output adjust range	See operating information	9.6		13.2	V
	Output voltage tolerance band	10-100 % of max $I_O$	11.75		12.30	V
	Idling voltage	$I_O = 0$ A	11.75		12.30	V
	Line regulation	max $I_O$		1.6	20	mV
	Load regulation	$V_I = 53$ V, 0-100 % of max $I_O$		1	10	mV
$V_{tr}$	Load transient voltage deviation	$V_I = 53$ V, Load step 25-75-25 % of max $I_O$ , $di/dt = 1$ A/ $\mu\text{s}$		$\pm 380$	$\pm 550$	mV
$t_{tr}$	Load transient recovery time			20	100	$\mu\text{s}$
$t_r$	Ramp-up time (from 10-90 % of $V_{Oi}$ )	10-100 % of max $I_O$	5	7.7	18	ms
$t_s$	Start-up time (from $V_I$ connection to 90 % of $V_{Oi}$ )		7	11.3	20	ms
$t_f$	$V_I$ shut-down fall time (from $V_I$ off to 10 % of $V_O$ )	max $I_O$		0.3		ms
		$I_O = 0$ A		2.2		s
$t_{RC}$	RC start-up time	max $I_O$		9		ms
	RC shut-down fall time (from RC off to 10 % of $V_O$ )	max $I_O$		0.3		ms
		$I_O = 0$ A		2.2		s
$I_O$	Output current		0		7.5	A
$I_{lim}$	Current limit threshold	$T_{ref} < \text{max } T_{ref}$	7.9	9.6	12	A
$I_{sc}$	Short circuit current	$T_{ref} = 25^{\circ}\text{C}$ , see Note 1		10	13	A
$V_{Oac}$	Output ripple & noise	See ripple & noise section, max $I_O$ , $V_{Oi}$		50	100	mVp-p
OVP	Over voltage protection	$T_{ref} = +25^{\circ}\text{C}$ , $V_I = 53$ V, 0-100 % of max $I_O$	14	15	17	V

Note 1: See Operating Information section.



PKB 4000 series  
DC/DC converters, Input 36-75 V, Output 30 A/90 W

EN/LZT 146 394 R6A November 2017

© Flex

## 12 V/7.5A Typical Characteristics

PKB 4913 PINB

### Efficiency

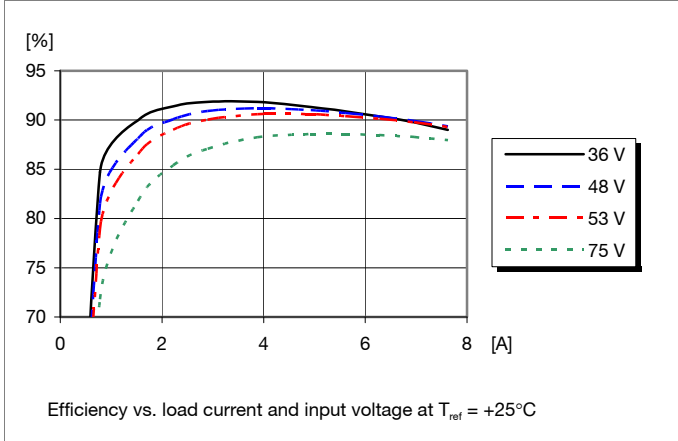

### Power Dissipation

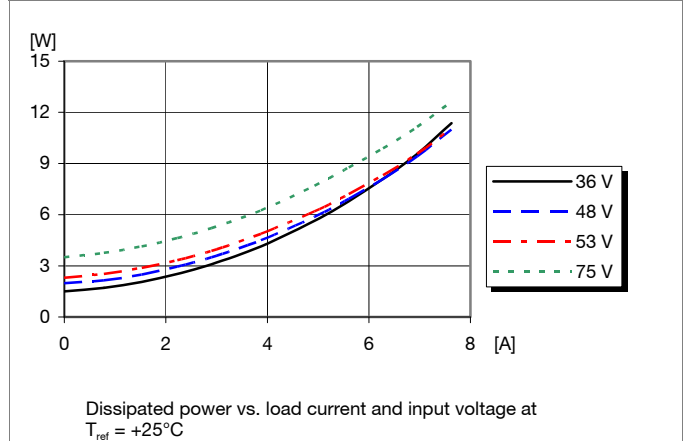

### Output Current Derating

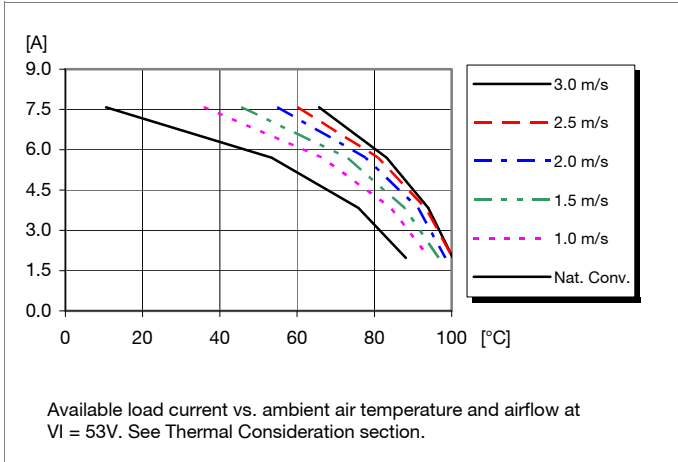

### Thermal Resistance

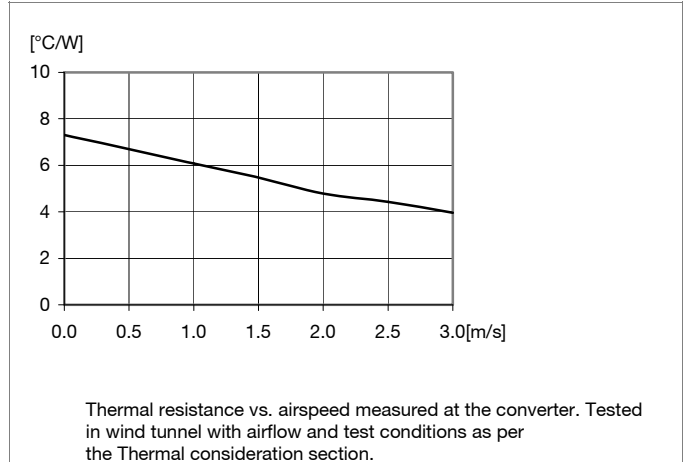

### Output Characteristics

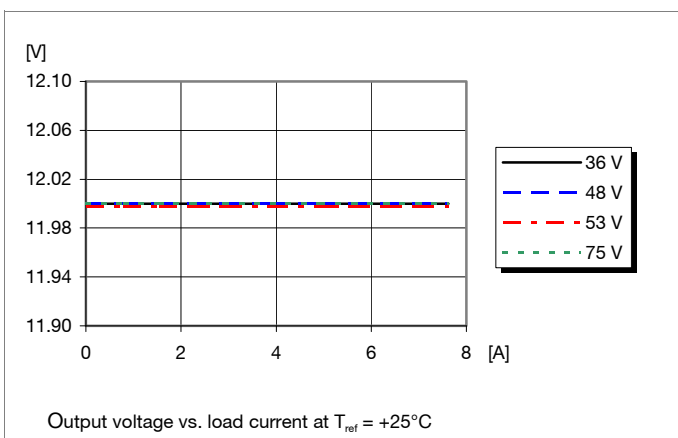

### Current Limit Characteristics

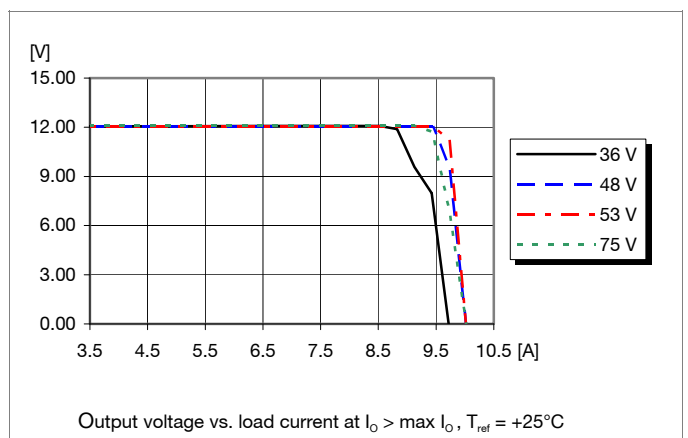

PKB 4000 series  
DC/DC converters, Input 36-75 V, Output 30 A/90 W

EN/LZT 146 394 R6A November 2017

© Flex

### 12 V/7.5 A Typical Characteristics

PKB 4913 PINB

#### Start-up

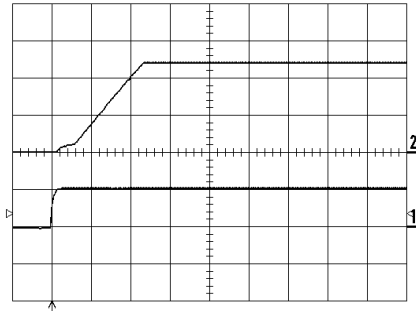

Start-up enabled by connecting VI at:  
Tref = +25°C, VI = 53 V,  
IO = 7.5 A resistive load.

Top trace: output voltage 5 V/div..  
Bottom trace: input voltage 50 V/div..  
Time scale: 5 ms/div..

#### Shut-down

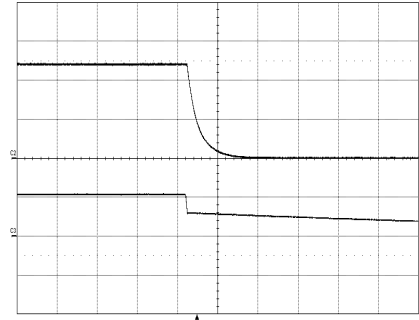

Shut-down enabled by disconnecting VI at:  
Tref = +25°C, VI = 53 V,  
IO = 7.5 A resistive load.

Top trace: output voltage 5 V/div..  
Bottom trace: input voltage 50 V/div..  
Time scale: 0.5 ms/div..

#### Output Ripple & Noise

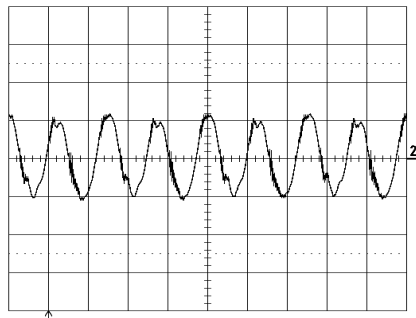

Output voltage ripple at:  
Tref = +25°C, VI = 53 V,  
IO = 7.5 A resistive load.

Trace: output voltage 20 mV/div.  
Time scale: 2 µs/div.

#### Output Load Transient Response

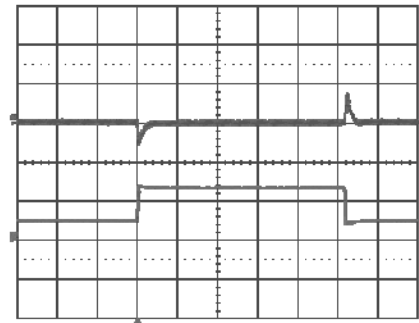

Output voltage response to load current step-  
change 1.875A-5.625A-1.875A at:  
Tref = +25°C, VI = 53 V.

Top trace: output voltage 500 mV/div.  
Bottom trace: load current 5 A/div).  
Time scale: 0.1 ms/div..

#### Output Voltage Adjust (see operating information)

##### Passive adjust

The resistor value for an adjusted output voltage is calculated by using the following equations:

Output Voltage Adjust Upwards, Increase:

$$R_{adj} = 5.11 \left( \frac{12(100 + \Delta\%)}{1.225 \times \Delta\%} - \frac{(100 + 2\Delta\%)}{\Delta\%} \right) \text{ k}\Omega$$

Example: Increase 2% => Vout = 12.24 Vdc

$$R_{adj} = 5.11 \left( \frac{12(100 + 2)}{1.225 \times 2} - \frac{(100 + 2 \times 2)}{2} \right) \text{ k}\Omega = 2287.2 \text{ k}\Omega$$

Output Voltage Adjust Downwards, Decrease:

$$R_{adj} = 5.11 \times \left( \frac{100}{\Delta\%} - 2 \right) \text{ k}\Omega$$

Example: Decrease 4% => Vout = 11.52Vdc

$$5.11 \times \left( \frac{100}{4} - 2 \right) \text{ k}\Omega = 117.5 \text{ k}\Omega$$

##### Active adjust

The output voltage may be adjusted using a {current/voltage} applied to the Vadj pin. This {current/voltage} is calculated by using the following equations:

$$V_{adj} = \left( 1.225 + 2.45 \times \frac{V_{desired} - 12}{12} \right) \text{ V}$$

Example: Upwards => 12.50 V

$$\left( 1.225 + 2.45 \times \frac{12.50 - 12}{12} \right) \text{ V} = 1.327 \text{ V}$$

Example: Downwards => 11.50 V

$$\left( 1.225 + 2.45 \times \frac{11.50 - 12}{12} \right) \text{ V} = 1.123 \text{ V}$$

PKB 4000 series DC/DC converters, Input 36-75 V, Output 30 A/90 W	EN/LZT 146 394 R6A November 2017
	© Flex

**15 V/5 A Electrical Specification**
**PKB 4715 PINB**

$T_{ref} = -40$  to  $+90^{\circ}\text{C}$ ,  $V_I = 36$  to  $75$  V, sense pins connected to output pins unless otherwise specified under Conditions.

Typical values given at:  $T_{ref} = +25^{\circ}\text{C}$ ,  $V_I = 53$  V, max  $I_O$ , unless otherwise specified under Conditions.

Additional  $C_{in} = 0$   $\mu\text{F}$  and  $C_{out} = 0$   $\mu\text{F}$ . See Operating Information section for selection of capacitor types.

Characteristics		Conditions	min	typ	max	Unit
$V_I$	Input voltage range		36		75	V
$V_{loff}$	Turn-off input voltage	Decreasing input voltage	30	31	32	V
$V_{lon}$	Turn-on input voltage	Increasing input voltage	33	34	35	V
$C_I$	Internal input capacitance			3.35		$\mu\text{F}$
$P_O$	Output power	Output voltage initial setting	0		75	W
$\eta$	Efficiency	50 % of max $I_O$		91.0		%
		max $I_O$		92.0		
		50 % of max $I_O$ , $V_I = 48$ V		91.5		
		max $I_O$ , $V_I = 48$ V		92.1		
$P_d$	Power Dissipation	max $I_O$		6.7	10	W
$P_{li}$	Input idling power	$I_O = 0$ A, $V_I = 53$ V		2.4		W
$P_{RC}$	Input standby power	$V_I = 53$ V (turned off with RC)		0.15		W
$f_s$	Switching frequency	0-100 % of max $I_O$		195		kHz

$V_{Oi}$	Output voltage initial setting and accuracy	$T_{ref} = +25^{\circ}\text{C}$ , $V_I = 53$ V, $I_O = 20$ A	14.70	15	15.30	V
$V_O$	Output adjust range	See operating information	12.00		16.50	V
	Output voltage tolerance band	10-100 % of max $I_O$	14.55		15.45	V
	Idling voltage	$I_O = 0$ A	14.55		15.45	V
	Line regulation	max $I_O$		3	10	mV
	Load regulation	$V_I = 53$ V, 0-100 % of max $I_O$		3	10	mV
$V_{tr}$	Load transient voltage deviation	$V_I = 53$ V, Load step 25-75-25 % of max $I_O$ , $di/dt = 3$ A/ $\mu\text{s}$		$\pm 400$	$\pm 520$	mV
$t_{tr}$	Load transient recovery time			10	20	$\mu\text{s}$
$t_r$	Ramp-up time (from 10-90 % of $V_{Oi}$ )	10-100 % of max $I_O$	5	10	15	ms
$t_s$	Start-up time (from $V_I$ connection to 90 % of $V_{Oi}$ )		4	15	80	ms
$t_f$	$V_I$ shut-down fall time (from $V_I$ off to 10 % of $V_{Oi}$ )	max $I_O$		0.5		ms
		$I_O = 0$ A		1.5		s
$t_{RC}$	RC start-up time	max $I_O$		10		ms
	RC shut-down fall time (from RC off to 10 % of $V_{Oi}$ )	max $I_O$		0.5		ms
		$I_O = 0$ A		1.5		s
$I_O$	Output current		0		5	A
$I_{lim}$	Current limit threshold	$T_{ref} < \text{max } T_{ref}$	5.3	6	6.8	A
$I_{sc}$	Short circuit current	$T_{ref} = 25^{\circ}\text{C}$ , see Note 1		8.4	8.5	A
$V_{Oac}$	Output ripple & noise	See ripple & noise section, max $I_O$ , $V_{Oi}$		70	150	mVp-p
OVP	Over voltage protection	$T_{ref} = +25^{\circ}\text{C}$ , $V_I = 53$ V, 0-100 % of max $I_O$	18	19	20	V

Note 1:  $V_o < 0.5$  V

PKB 4000 series  
DC/DC converters, Input 36-75 V, Output 30 A/90 W

EN/LZT 146 394 R6A November 2017

© Flex

## 15 V/5 A Typical Characteristics

PKB 4715 PINB

### Efficiency

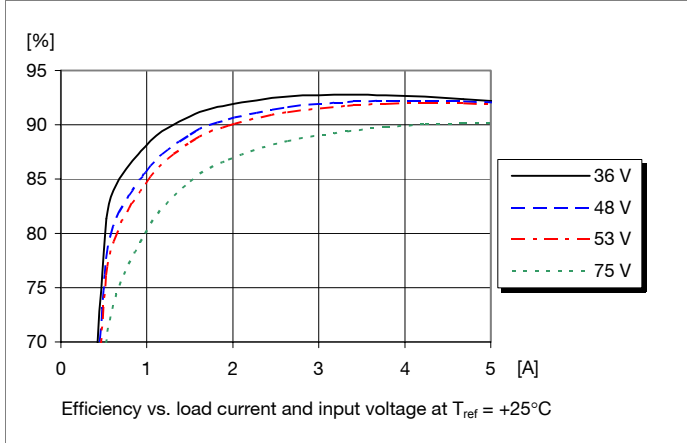

### Power Dissipation

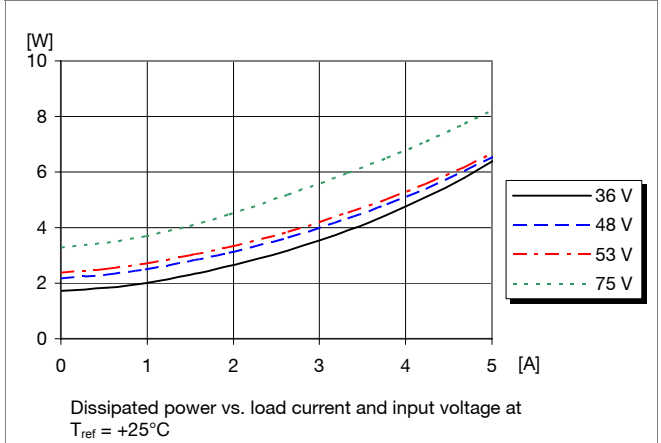

### Output Current Derating

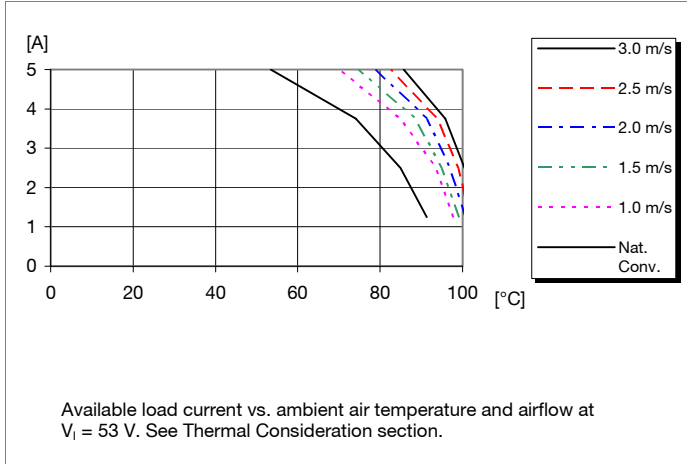

### Thermal Resistance

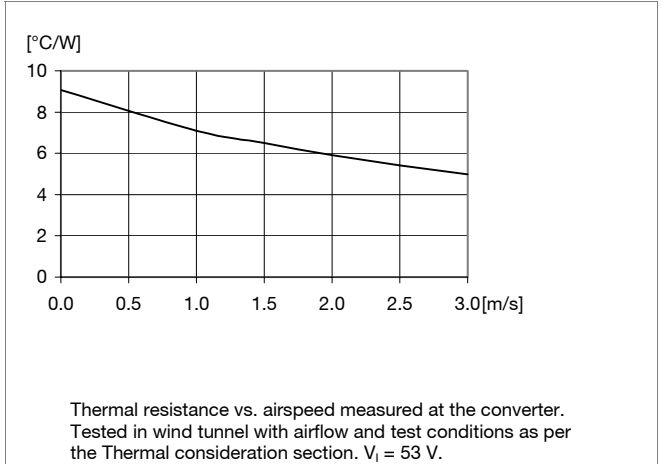

### Output Characteristics

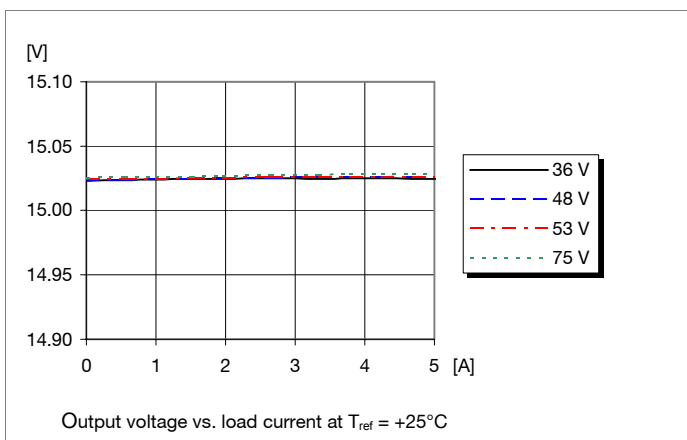

### Current Limit Characteristics

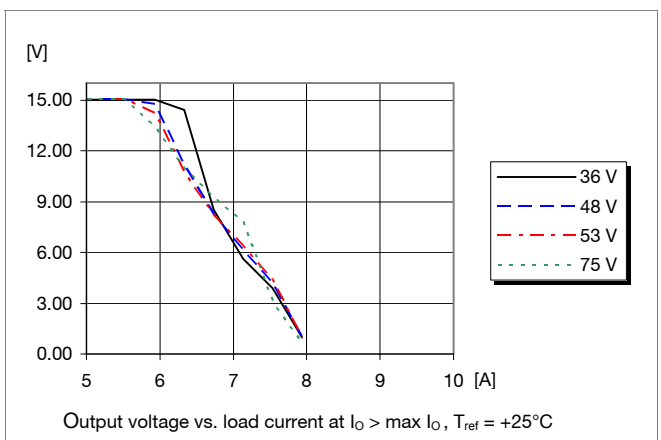

PKB 4000 series  
DC/DC converters, Input 36-75 V, Output 30 A/90 W

EN/LZT 146 394 R6A November 2017

© Flex

## 15 V/5 A Typical Characteristics

PKB 4715 PINB

### Start-up

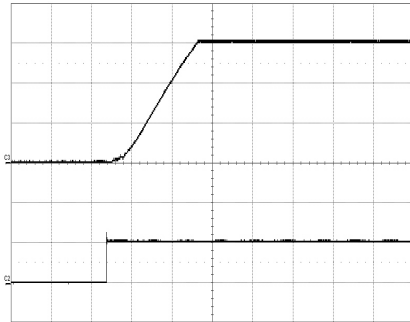

Start-up enabled by connecting  $V_i$  at:  
 $T_{ref} = +25^\circ\text{C}$ ,  $V_i = 53\text{ V}$ ,  
 $I_o = 5\text{ A}$  resistive load.

Top trace: output voltage (5 V/div.).  
Bottom trace: input voltage (50 V/div.).  
Time scale: (5 ms/div.).

### Shut-down

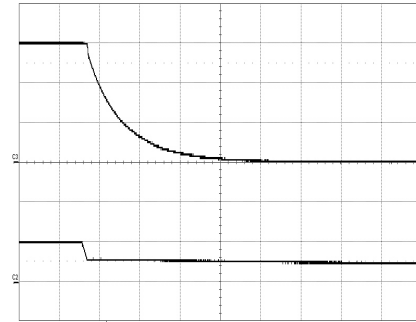

Shut-down enabled by disconnecting  $V_i$  at:  
 $T_{ref} = +25^\circ\text{C}$ ,  $V_i = 53\text{ V}$ ,  
 $I_o = 5\text{ A}$  resistive load.

Top trace: output voltage (5 V/div.).  
Bottom trace: input voltage (50 V/div.).  
Time scale: (0.2 ms/div.).

### Output Ripple & Noise

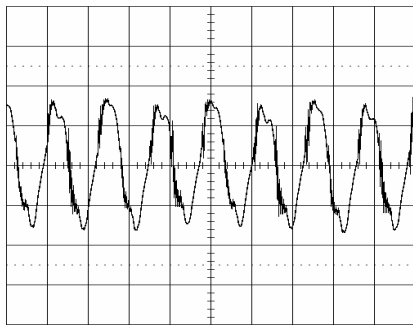

Output voltage ripple at:  
 $T_{ref} = +25^\circ\text{C}$ ,  $V_i = 53\text{ V}$ ,  
 $I_o = 5\text{ A}$  electrical load.

Trace: output voltage (20 mV/div.).  
Time scale: (2  $\mu\text{s}$ /div.).

### Output Load Transient Response

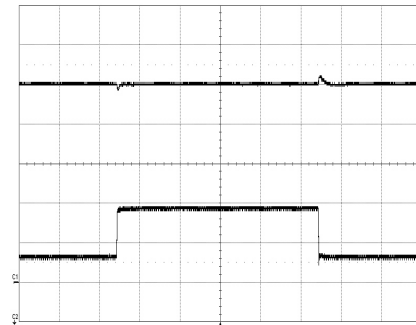

Output voltage response to load current step-change ((1.25-3.75-1.25A) at:  
 $T_{ref} = +25^\circ\text{C}$ ,  $V_i = 53\text{ V}$ .

Top trace: output voltage (2 V/div.).  
Bottom trace: load current (2 A/div.).  
Time scale: (0.1 ms/div.).

### Output Voltage Adjust (see operating information)

#### Passive adjust

The resistor value for an adjusted output voltage is calculated by using the following equations:

Output Voltage Adjust Upwards, Increase:

$$R_{adj} = \left( \frac{5.11 \times 15(100 + \Delta\%)}{1.225 \times \Delta\%} - \frac{511}{\Delta\%} - 10.22 \right) \text{ k}\Omega$$

Output Voltage Adjust Downwards, Decrease:

$$R_{adj} = 5.11 \times \left( \frac{100}{\Delta\%} - 2 \right) \text{ k}\Omega$$

Example: Increase 4%  $\Rightarrow V_{out} = 15.6\text{ Vdc}$

$$\left( \frac{5.11 \times 15(100 + 4)}{1.225 \times 4} - \frac{511}{4} - 10.22 \right) \text{ k}\Omega = 1488.90 \text{ k}\Omega$$

Decrease 4%  $\Rightarrow V_{out} = 14.4\text{ Vdc}$

$$5.11 \times \left( \frac{100}{4} - 2 \right) \text{ k}\Omega = 117.5 \text{ k}\Omega$$

PKB 4000 series  
DC/DC converters, Input 36-75 V, Output 30 A/90 W

EN/LZT 146 394 R6A November 2017

© Flex

### EMC Specification

Conducted EMI measured according to EN55022, CISPR 22 and FCC part 15J (see test set-up). See Design Note 009 for further information. The fundamental switching frequency is 198 kHz for PKB4711 SINB @  $V_I = 53$  V, max  $I_o$ .

#### Conducted EMI Input terminal value (typ)

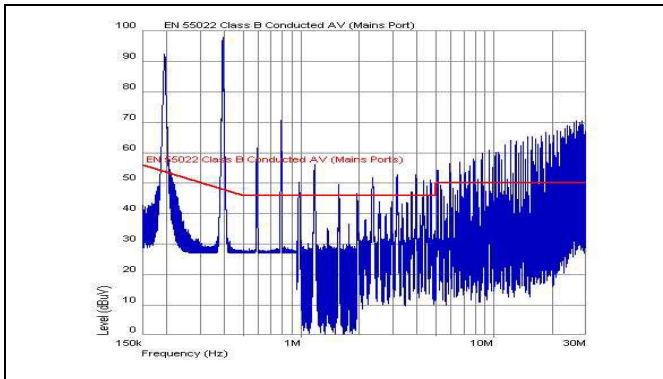

EMI without filter

#### External filter (class B)

Required external input filter in order to meet class B in EN 55022, CISPR 22 and FCC part 15J.

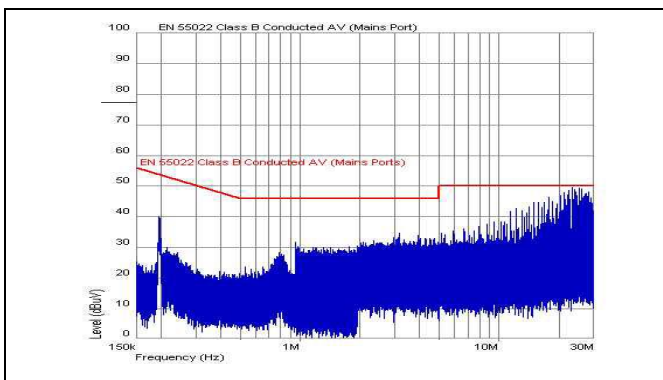
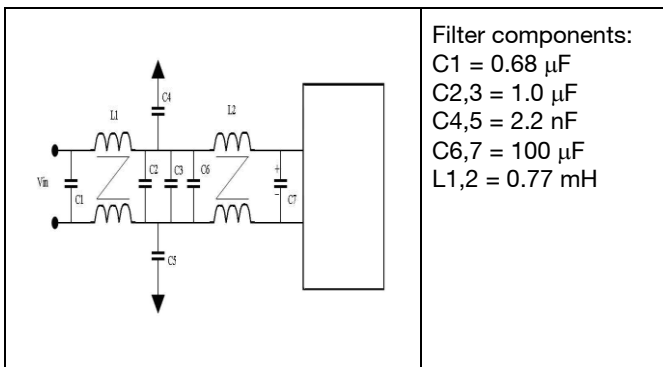

EMI with filter

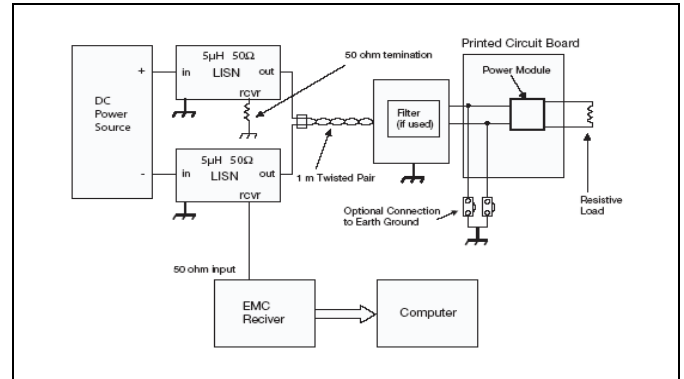

Test set-up

#### Layout recommendation

The radiated EMI performance of the DC/DC converter will depend on the PCB layout and ground layer design. It is also important to consider the stand-off of the DC/DC converter.

If a ground layer is used, it should be connected to the output of the DC/DC converter and the equipment ground or chassis.

A ground layer will increase the stray capacitance in the PCB and improve the high frequency EMC performance.

#### Output ripple and noise

Output ripple and noise measured according to figure below. See Design Note 022 for detailed information.

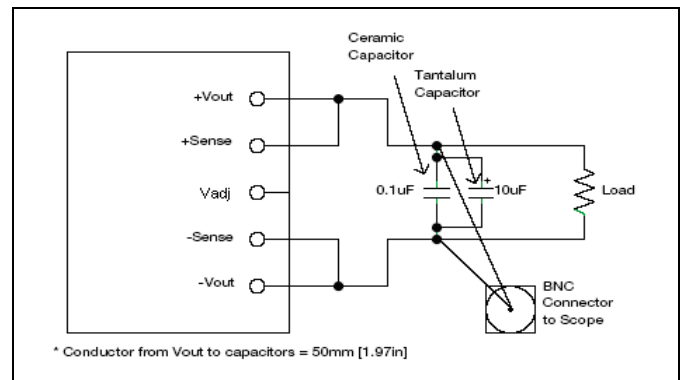

Output ripple and noise test setup

PKB 4000 series  
DC/DC converters, Input 36-75 V, Output 30 A/90 W

EN/LZT 146 394 R6A November 2017

© Flex

## Operating information

### Input Voltage

The input voltage range 36 to 75Vdc meets the requirements of the European Telecom Standard ETS 300 132-2 for normal input voltage range in -48 and -60 Vdc systems, -40.5 to -57.0 V and -50.0 to -72 V respectively.

At input voltages exceeding 75 V, the power loss will be higher than at normal input voltage and  $T_{ref}$  must be limited to absolute max +110°C. The absolute maximum continuous input voltage is 80 Vdc.

### Turn-off Input Voltage

The DC/DC converters monitor the input voltage and will turn on and turn off at predetermined levels.

The minimum hysteresis between turn on and turn off input voltage is 3V.

### Remote Control (RC)

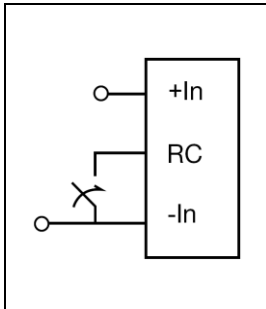

The products are fitted with a remote control function referenced to the primary negative input connection (- In), with negative and positive logic options available. The RC function allows the converter to be turned on/off by an external device like a semiconductor or mechanical switch. The RC pin has an internal pull up resistor to  $V_{cc}$  pin of controller IC.

The maximum required sink current is 1 mA. When the RC pin is left open, the voltage generated on the RC pin is around 6 V. The second option is “positive logic” remote control, which can be ordered by adding the suffix “P” to the end of the part number. The converter will turn on when the input voltage is applied with the RC pin open. Turn off is achieved by connecting the RC pin to the - In. To ensure safe turn off the voltage difference between RC pin and the - In pin shall be less than 1V. The converter will restart automatically when this connection is opened.

See Design Note 021 for detailed information.

### Input and Output Impedance

The impedance of both the input source and the load will interact with the impedance of the DC/DC converter. It is important that the input source has low characteristic impedance. The converters are designed for stable operation without external capacitors connected to the input or output. The performance in some applications can be enhanced by addition of external capacitance as described under External Decoupling Capacitors. If the input voltage source contains significant inductance, the addition of a 100  $\mu$ F capacitor across the input of the converter will ensure stable operation. The capacitor is not required when powering the DC/DC converter from an input source with an inductance below 10  $\mu$ H.

### External Decoupling Capacitors

When powering loads with significant dynamic current requirements, the voltage regulation at the point of load can be improved by addition of decoupling capacitors at the load. The most effective technique is to locate low ESR ceramic and electrolytic capacitors as close to the load as possible, using several parallel capacitors to lower the effective ESR. The ceramic capacitors will handle high-frequency dynamic load changes while the electrolytic capacitors are used to handle low frequency dynamic load changes. Ceramic capacitors will also reduce any high frequency noise at the load.

It is equally important to use low resistance and low inductance PCB layouts and cabling.

External decoupling capacitors will become part of the control loop of the DC/DC converter and may affect the stability margins. As a “rule of thumb”, 100  $\mu$ F/A of output current can be added without any additional analysis. The ESR of the capacitors is a very important parameter. Power Modules guarantee stable operation with a verified ESR value of >10 m $\Omega$  across the output connections.

For further information please contact your local Flex representative.

### Output Voltage Adjust ( $V_{adj}$ )

The DC/DC converters have an Output Voltage Adjust pin ( $V_{adj}$ ). This pin can be used to adjust the output voltage above or below Output voltage initial setting.

When increasing the output voltage, the voltage at the output pins (including any remote sense compensation ) must be kept below the threshold of the over voltage protection, (OVP) to prevent the converter from shutting down. At increased output voltages the maximum power rating of the converter remains the same, and the max output current must be decreased correspondingly.

To increase the voltage the resistor should be connected between the  $V_{adj}$  pin and +Sense pin. The resistor value of the Output voltage adjust function is according to information given under the Output section for the respective product.

To decrease the output voltage, the resistor should be connected between the  $V_{adj}$  pin and -Sense pin.

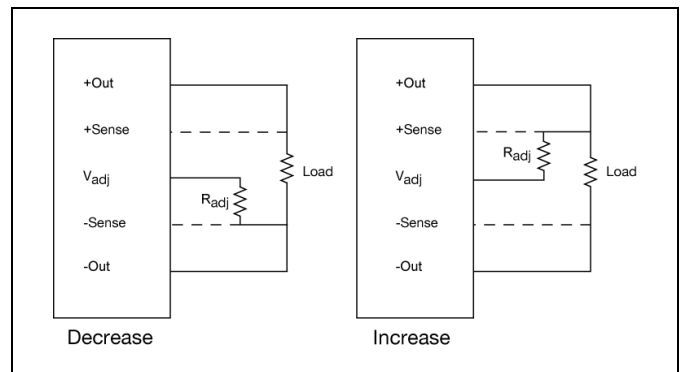

PKB 4000 series  
DC/DC converters, Input 36-75 V, Output 30 A/90 W

EN/LZT 146 394 R6A November 2017

© Flex

### Operating information continued

#### Parallel Operation

Two converters may be paralleled for redundancy if the total power is equal or less than  $P_o$  max. It is not recommended to parallel the converters without using external current sharing circuits.

See Design Note 006 for detailed information.

#### Remote Sense

The DC/DC converters have remote sense that can be used to compensate for voltage drops between the output and the point of load. The sense traces should be located close to the PCB ground layer to reduce noise susceptibility. The remote sense circuitry will compensate for up to 10% voltage drop between output pins and the point of load.

If the remote sense is not needed +Sense should be connected to +Out and -Sense should be connected to -Out.

#### Over Temperature Protection (OTP)

The converters are protected from thermal overload by the control IC.

When  $T_{ref}$  as defined in thermal consideration section exceeds 135°C the converter will shut down. The DC/DC converter will make continuous attempts to start up (non-latching mode) and resume normal operation automatically when the temperature has dropped >10°C below the temperature threshold.

#### Over Voltage Protection (OVP)

The converters have output over voltage protection that will shut down the converter in over voltage conditions. The converter will make continuous attempts to start up (non-latching mode) and resume normal operation automatically after removal of the over voltage condition.

#### Over Current Protection (OCP)

The converters include current limiting circuitry for protection at continuous overload.

The output voltage will decrease towards zero for output currents in excess of max output current ( $I_o$ ). The converter will resume normal operation after removal of the overload. The load distribution should be designed for the maximum output short circuit current specified.

### Thermal Consideration

#### General

The converters are designed to operate in different thermal environments and sufficient cooling must be provided to ensure reliable operation.

Cooling is achieved mainly by conduction, from the pins to the host board, and convection, which is dependant on the airflow across the converter. Increased airflow enhances the cooling of the converter.

The Output Current Derating graph found in the Output section for each model provides the available output current vs. ambient air temperature and air velocity at  $V_{in} = 53$  V.

The DC/DC converter is tested on a 254 x 254 mm, 35  $\mu$ m (1 oz), 8-layer test board mounted vertically in a wind tunnel with a cross-section of 305 x 305 mm.

Proper cooling of the DC/DC converter can be verified by measuring the temperature at positions P1, P2 and P3. The temperature at these positions should not exceed the max values provided in the table below.

Note that the max value is the absolute maximum rating (non destruction) and that the electrical Output data is guaranteed up to  $T_{ref} + 90^\circ\text{C}$ .

See Design Note 019 for further information.

Position	Device	Designation	max value
P <sub>1</sub>	Pcb		110° C
P <sub>2</sub>	Mosfet		120° C
P <sub>3</sub>	Mosfet	$T_{ref}$	120° C

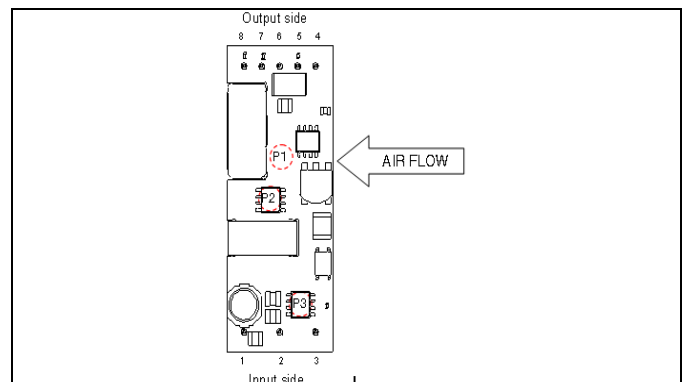



PKB 4000 series  
DC/DC converters, Input 36-75 V, Output 30 A/90 W

EN/LZT 146 394 R6A November 2017

© Flex

### Thermal Consideration continued

#### Definition of reference temperature ( $T_{ref}$ )

The reference temperature is used to monitor the temperature limits of the product. Temperatures above maximum  $T_{ref}$  are not allowed and may cause degradation or permanent damage to the product.  $T_{ref}$  is also used to define the temperature range for normal operating conditions.  $T_{ref}$  is defined by the design and used to guarantee safety margins, proper operation and high reliability of the module.

#### Ambient Temperature Calculation

By using the thermal resistance the maximum allowed ambient temperature can be calculated.

- The power loss is calculated by using the formula  $((1/\eta) - 1) \times \text{output power} = \text{power losses (Pd)}$ .  
 $\eta$  = efficiency of converter. E.g 89.0 % = 0.89
- Find the thermal resistance ( $R_{th}$ ) in the Thermal Resistance graph found in the Output section for each model. Calculate the temperature increase ( $\Delta T$ ).  
 $\Delta T = R_{th} \times P_d$
- Max allowed ambient temperature is:  
Max  $T_{ref} - \Delta T$ .

E.g PKB 4711 SINB at 1m/s:

- $((\frac{1}{0.89}) - 1) \times 75 \text{ W} = 9.26 \text{ W}$
- $9.26 \text{ W} \times 6.3^\circ\text{C/W} = 58.3^\circ\text{C}$
- $120^\circ\text{C} - 58.3^\circ\text{C} = \text{max ambient temperature is } 61.6^\circ\text{C}$

The actual temperature will be dependent on several factors such as the PCB size, number of layers and direction of airflow.

### Connections

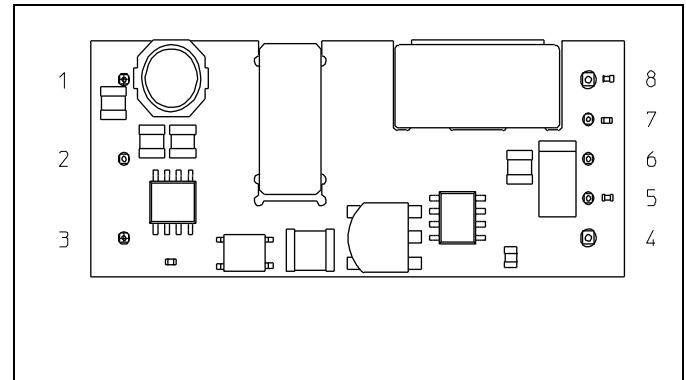

Pin	Designation	Function
1	+In	Positive input
2	RC	Remote control
3	-In	Negative input
4	-Out	Negative output
5	-Sen	Negative remote sense
6	Vadj	Output voltage adjust
7	+Sen	Positive remote sense
8	+Out	Positive output

PKB 4000 series  
DC/DC converters, Input 36-75 V, Output 30 A/90 W

EN/LZT 146 394 R6A November 2017

© Flex

### Mechanical Information - Surface mount version

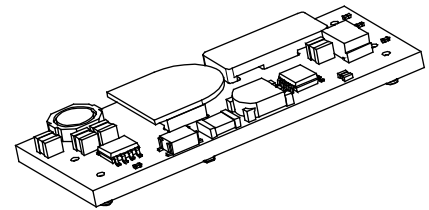
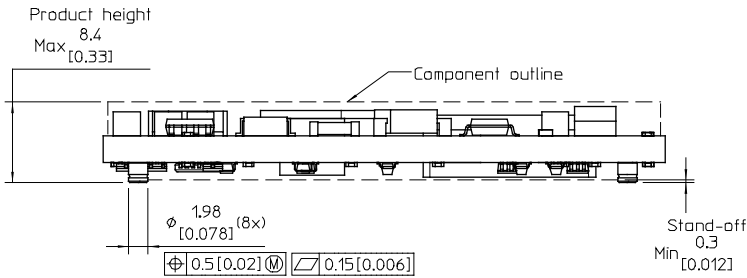

TOP VIEW

Pin positions according to recommended footprint

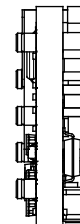
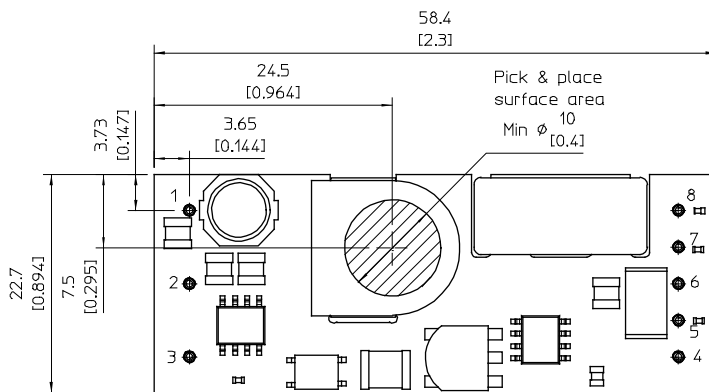

RECOMMENDED FOOTPRINT  
TOP VIEW

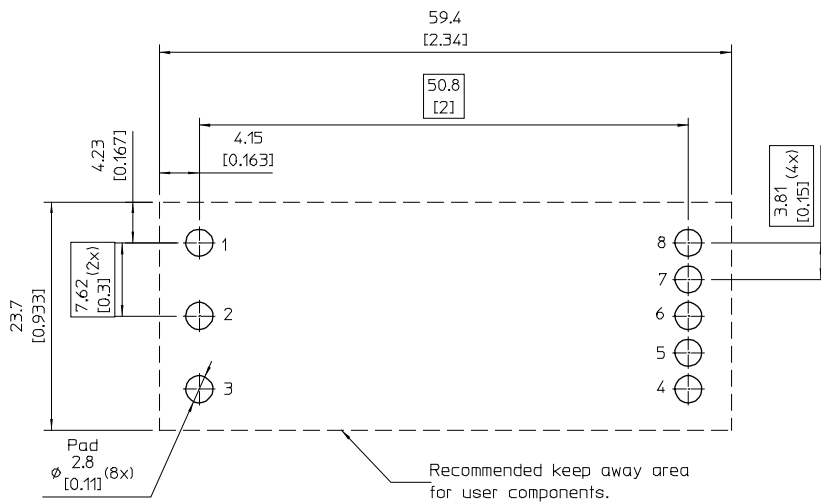

**Layout considerations:**

User sufficient numbers of vias connected to output pin pads for good thermal and current conductivity.

**Pins:**

Material: Copper alloy  
Plating: 0.1  $\mu$ m Au over 2  $\mu$ m Ni

Weight: typical 20 g

All dimensions in mm [inch].

Tolerances unless specified

x.x mm  $\pm$  0.5 mm [0.02]

x.xx mm  $\pm$  0.25 mm [0.01]

(not applied on footprint or typical values)



PKB 4000 series  
DC/DC converters, Input 36-75 V, Output 30 A/90 W

EN/LZT 146 394 R6A November 2017

© Flex

### Mechanical Information- Through hole mount version

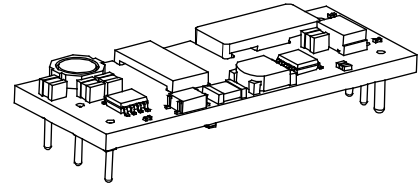
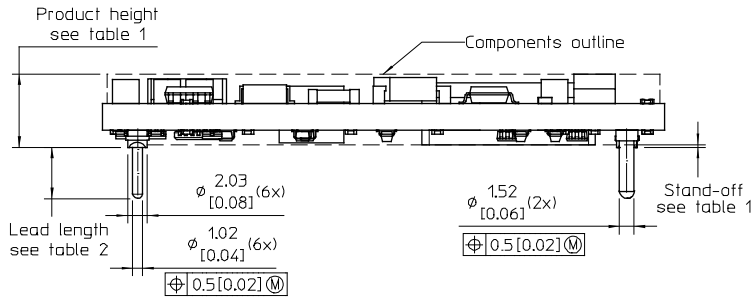

#### TOP VIEW

Pin positions according to recommended footprint

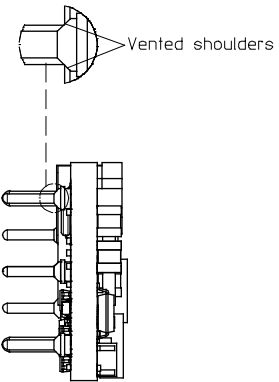
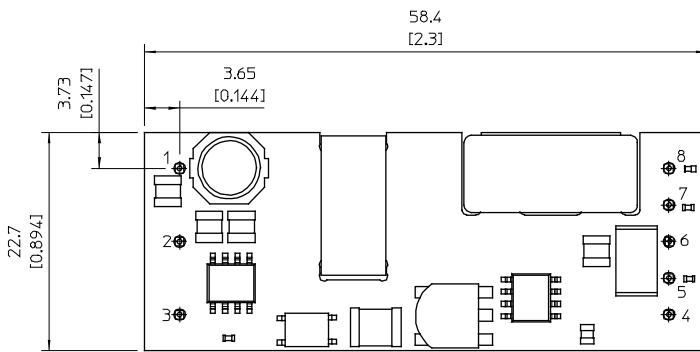

#### RECOMMENDED FOOTPRINT

##### TOP VIEW

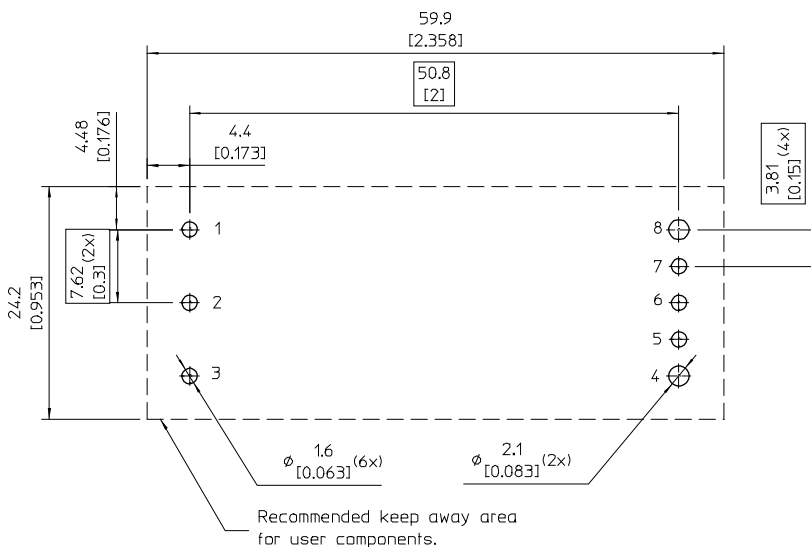

Table 1

Height option	Max. Product height	Min. Stand-off
Standard	8.10 [0.32]	0 [0.0]
M-option	9.15 [0.36]	1.0 [0.04]

Table 2

Pin option	Lead Length
Standard	5.33 [0.21]
LA	3.69 [0.145]
LB	4.57 [0.18]

Pins:  
Material, pins 1-3, 5-7: Brass  
Material, pins 4, 8: Copper alloy  
Plating: 0.1  $\mu$ m Au over 2  $\mu$ m Ni

Weight: typical 21 g

All dimensions in mm [inch].  
Tolerances unless specified  
x.x mm  $\pm$  0.5 mm [0.02]  
x.xx mm  $\pm$  0.25 mm [0.01]  
(not applied on footprint or typical values)



PKB 4000 series  
DC/DC converters, Input 36-75 V, Output 30 A/90 W

EN/LZT 146 394 R6A November 2017

© Flex

### Soldering Information - Surface Mounting

The surface mount version of the product is intended for convection or vapor phase reflow SnPb and Pb-free processes. To achieve a good and reliable soldering result, make sure to follow the recommendations from the solder paste supplier, to use state-of-the-art reflow equipment and reflow profiling techniques as well as the following guidelines.

A no-clean flux is recommended to avoid entrapment of cleaning fluids in cavities inside the product or between the product and the host board. The cleaning residues may affect long time reliability and isolation voltage.

### Minimum Pin Temperature Recommendations

Pin number 4 is chosen as reference location for the minimum pin temperature recommendations since this will likely be the coolest solder joint during the reflow process.

Pin 2 for measurement of maximum peak product reflow temperature,  $T_p$

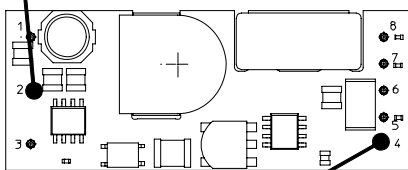

Pin 4 for measurement of minimum solder joint temperature,  $T_{PIN}$

### SnPb solder processes

For SnPb solder processes, a pin temperature ( $T_{PIN}$ ) in excess of the solder melting temperature, ( $T_L$ , +183°C for Sn63/Pb37) for more than 30 seconds, and a peak temperature of +210°C is recommended to ensure a reliable solder joint.

### Lead-free (Pb-free) solder processes

For Pb-free solder processes, a pin temperature ( $T_{PIN}$ ) in excess of the solder melting temperature ( $T_L$ , +217 to +221°C for Sn/Ag/Cu solder alloys) for more than 30 seconds, and a peak temperature of +235°C on all solder joints is recommended to ensure a reliable solder joint.

### Peak Product Temperature Requirements

Pin number 2 is chosen as reference location for the maximum (peak) allowed product temperature ( $T_p$ ) since this will likely be the warmest part of the product during the reflow process.

To avoid damage or performance degradation of the product, the reflow profile should be optimized to avoid excessive heating. A sufficiently extended preheat time is recommended to ensure an even temperature across the host PCB, for both small and large devices. To reduce the risk of excessive heating is also recommended to reduce the time in the reflow zone as much as possible.

### SnPb solder processes

For SnPb solder processes, the product is qualified for MSL 1 according to IPC/JEDEC standard J-STD-020C.

During reflow,  $T_p$  must not exceed +225°C at any time.

### Lead-free (Pb-free) solder processes

For Pb-free solder processes, the product is qualified for MSL 3 according to IPC/JEDEC standard J-STD-020C.

During reflow,  $T_p$  must not exceed +260°C at any time.

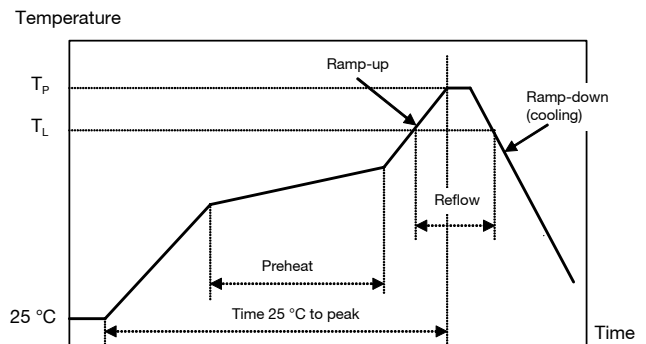

Reflow process specifications		Sn/Pb eutectic	Pb-free
Average ramp-up rate		3°C/s max	3°C/s max
Solder melting temperature (typical)	$T_L$	+183°C	+221°C
Minimum time above $T_L$		30 s	30 s
Minimum pin temperature	$T_{PIN}$	+210°C	+235°C
Peak product temperature	$T_p$	+225°C	+260°C
Average ramp-down rate		6°C/s max	6°C/s max
Time 25°C to peak		6 minutes max	8 minutes max

PKB 4000 series  
DC/DC converters, Input 36-75 V, Output 30 A/90 W

EN/LZT 146 394 R6A November 2017

© Flex

### Soldering Information – Through Hole Mounting

The through hole mount version of the product is intended for manual or wave soldering. When wave soldering is used, the temperature on the pins is specified to maximum 270°C for maximum 10 seconds.

A maximum preheat rate of 4°C/s and a temperature of max +150°C is suggested. When soldering by hand, care should be taken to avoid direct contact between the hot soldering iron tip and the pins for more than a few seconds in order to prevent overheating.

A no-clean flux is recommended to avoid entrapment of cleaning fluids in cavities inside the product or between the product and the host board. The cleaning residues may affect long time reliability and isolation voltage.

### Delivery Package Information, Surface Mount Version

The surface mount versions of the products are delivered in antistatic injection molded trays (Jedec design guide 4.10D standard).

Tray Specifications	
<b>Material</b>	PPE, Antistatic
<b>Surface resistance</b>	$10^5 < \text{Ohm/square} < 10^{12}$
<b>Bakability</b>	The trays can be baked at maximum 125°C for 48 hours
<b>Tray capacity</b>	20 products/tray
<b>Tray thickness</b>	13.4 mm [0.528 inch]
<b>Box capacity</b>	100 products (5 full trays/box)
<b>Tray weight</b>	110 g empty, 530 g full tray

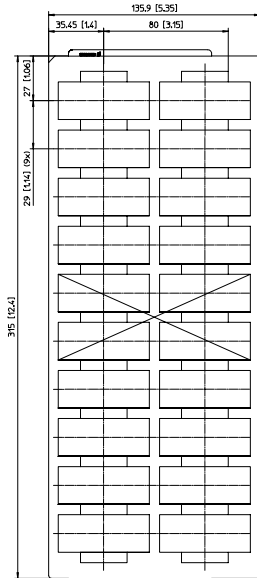

X = Vacuum pickup area.

### Delivery Package Information, Through Hole Mounting Version

The products are delivered in antistatic clamshell.

Clamshell Specifications	
<b>Material</b>	PET with antistatic coated
<b>Surface resistance</b>	$10^6 < \text{Ohm/square} < 10^{12}$
<b>Bake ability</b>	The clamshells are not bake-able.
<b>Clamshell capacity</b>	20 products/clamshell
<b>Clamshell thickness</b>	20 mm [0.787 inch]
<b>Box capacity</b>	100 products (5 full trays/box)
<b>Clamshell weight</b>	130 g empty, 530 g full tray

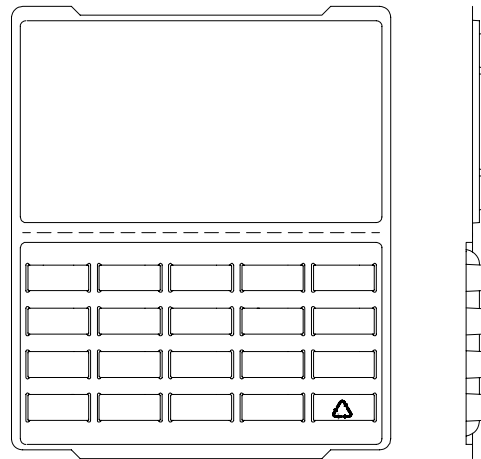

### Non-Dry Pack Information

The through hole mount version of product is delivered in non-dry packing clamshells.

### Dry Pack Information

The surface mount versions of the products are delivered in trays. These inner shipment containers are dry packed in standard moisture barrier bags according to IPC/JEDEC standard J-STD-033 (Handling, packing, shipping and use of moisture/reflow sensitivity surface mount devices).

Using products in high temperature Pb-free soldering processes requires dry pack storage and handling. In case the products have been stored in an uncontrolled environment and no longer can be considered dry, the modules must be baked according to J-STD-033.

PKB 4000 series DC/DC converters, Input 36-75 V, Output 30 A/90 W	EN/LZT 146 394 R6A November 2017
	© Flex

**Product Qualification Specification**

Characteristics			
External visual inspection	IPC-A-610		
Change of temperature (Temperature cycling)	IEC 60068-2-14 Na	Temperature range Number of cycles Dwell/transfer time	-40 to +100°C 1000 15 min/0-1 min
Cold (in operation)	IEC 60068-2-1 Ad	Temperature T <sub>A</sub> Duration	-45°C 72 h
Damp heat	IEC 60068-2-67 Cy	Temperature Humidity Duration	+85°C 85 % RH 1000 hours
Dry heat	IEC 60068-2-2 Bd	Temperature Duration	+125°C 1000 h
Electrostatic discharge susceptibility	IEC 61340-3-1, JESD 22-A114 IEC 61340-3-2, JESD 22-A115	Human body model (HBM) Machine Model (MM)	Class 2, 2000 V Class 3, 200 V
Immersion in cleaning solvents	IEC 60068-2-45 XA Method 2	Water Glycol ether Isopropyl alcohol	+55°C +35°C +35°C
Mechanical shock	IEC 60068-2-27 Ea	Peak acceleration Duration	100 g 6 ms
Moisture reflow sensitivity <sup>1</sup>	J-STD-020C	Level 1 (SnPb-eutectic) Level 3 (Pb Free)	225°C 260°C
Operational life test	MIL-STD-202G method 108A	Duration	1000 h
Resistance to soldering heat <sup>2</sup>	IEC 60068-2-20 Tb Method 1A	Solder temperature Duration	270°C 10-13 s
Robustness of terminations	IEC 60068-2-21 Test Ua1 IEC 60068-2-21 Test Ue1	Through hole mount products Surface mount products	All leads All leads
Solderability	IEC 60068-2-58 test Td <sup>1</sup>	Preconditioning Temperature, SnPb Eutectic Temperature, Pb-free	150°C dry bake 16 h 215°C 235°C
	IEC 60068-2-20 test Ta <sup>2</sup>	Preconditioning Temperature, SnPb Eutectic Temperature, Pb-free	Steam ageing 235°C 245°C
Vibration, broad band random	IEC 60068-2-64 Fh, method 1	Frequency Spectral density Duration	10 to 500 Hz 0.07 g <sup>2</sup> /Hz 10 min in each perpendicular direction

Note 1: Only for products intended for reflow soldering (surface mount products)

Note 2: Only for products intended for wave soldering (plated through hole products)



Компания «ЭлектроПласт» предлагает заключение долгосрочных отношений при поставках импортных электронных компонентов на взаимовыгодных условиях!

Наши преимущества:

- Оперативные поставки широкого спектра электронных компонентов отечественного и импортного производства напрямую от производителей и с крупнейших мировых складов;
- Поставка более 17-ти миллионов наименований электронных компонентов;
- Поставка сложных, дефицитных, либо снятых с производства позиций;
- Оперативные сроки поставки под заказ (от 5 рабочих дней);
- Экспресс доставка в любую точку России;
- Техническая поддержка проекта, помощь в подборе аналогов, поставка прототипов;
- Система менеджмента качества сертифицирована по Международному стандарту ISO 9001;
- Лицензия ФСБ на осуществление работ с использованием сведений, составляющих государственную тайну;
- Поставка специализированных компонентов (Xilinx, Altera, Analog Devices, Intersil, Interpoint, Microsemi, Aeroflex, Peregrine, Syfer, Eurofarad, Texas Instrument, Miteq, Cobham, E2V, MA-COM, Hittite, Mini-Circuits, General Dynamics и др.);

Помимо этого, одним из направлений компании «ЭлектроПласт» является направление «Источники питания». Мы предлагаем Вам помощь Конструкторского отдела:

- Подбор оптимального решения, техническое обоснование при выборе компонента;
- Подбор аналогов;
- Консультации по применению компонента;
- Поставка образцов и прототипов;
- Техническая поддержка проекта;
- Защита от снятия компонента с производства.



#### Как с нами связаться

**Телефон:** 8 (812) 309 58 32 (многоканальный)

**Факс:** 8 (812) 320-02-42

**Электронная почта:** [org@eplast1.ru](mailto:org@eplast1.ru)

**Адрес:** 198099, г. Санкт-Петербург, ул. Калинина, дом 2, корпус 4, литера А.