

DPDT SWITCH GaAs MMIC

■GENERAL DESCRIPTION

NJG1528HD3 is a GaAs high power DPDT switch MMIC for antenna switch of tri- and dual-mode cellular phone application such as CDMA, AMPS and PCS.

This switch features low loss, high isolation at high power.

The ultra small & ultra thin USB6-D3 package is applied.

■PACKAGE OUTLINE

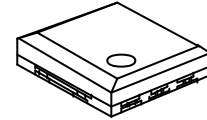

NJG1528HD3

■FEATURES

- Low voltage operation 2.5V min.
- Pin at 0.2dB compression point 36dBm typ. @f=1.9GHz, $V_{CTL}=2.8V$
- Low insertion loss 0.60dB typ. @f=0.9GHz, $P_{IN}=31dBm$, $V_{CTL}=2.8V$
0.70dB typ. @f=1.9GHz, $P_{IN}=25dBm$, $V_{CTL}=2.8V$
- High isolation 23dB typ. @f=0.9GHz, $P_{IN}=31dBm$, $V_{CTL}=2.8V$
17dB typ. @f=1.9GHz, $P_{IN}=25dBm$, $V_{CTL}=2.8V$
- Low control current 10uA typ. @f=0.9GHz, $P_{IN}=31dBm$, $V_{CTL}=2.8V$
- Ultra small & ultra thin package USB6-D3 (Package size: 2.0x1.8x0.8mm)

■PIN CONFIGURATION

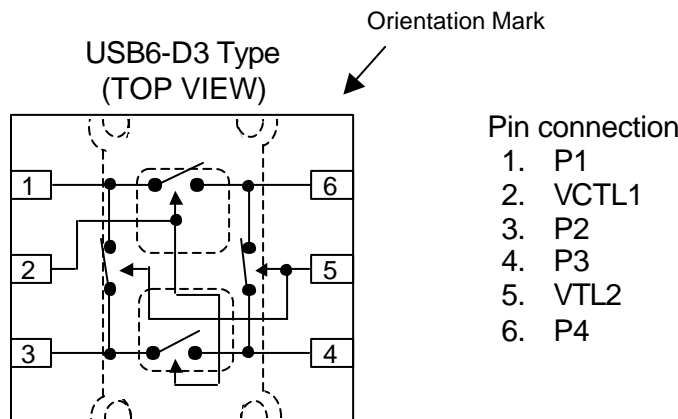

■TRUTH TABLE

ON Pass	VCTL1	VCTL2
P1-P2	L	H
P3-P4	L	H
P1-P4	H	L
P2-P3	H	L

NOTE: Please note that any information on this catalog is subject to change.

NJG1528HD3

■ABSOLUTE MAXIMUM RATINGS

($T_a=+25^{\circ}\text{C}$, $Z_s=Z_l=50\Omega$)

PARAMETER	SYMBOL	CONDITIONS	RATINGS	UNITS
RF Input Power	P_{IN}	$V_{CTL(L)}=0\text{V}$, $V_{CTL(H)}=3\text{V}$	37.5	dBm
Operating Voltage	V_{CTL}	$V_{CTL(H)}-V_{CTL(L)}$	12	V
Power Dissipation	P_D		200	mW
Operating Temp.	T_{opr}		-40~+85	$^{\circ}\text{C}$
Storage Tempe.	T_{stg}		-55~+150	$^{\circ}\text{C}$

■ELECTRICAL CHARACTERISTICS

(General conditions: $T_a=+25^{\circ}\text{C}$, $Z_s=Z_l=50\Omega$, $V_{CTL(L)}=0\text{V}$, $V_{CTL(H)}=2.8\text{V}$)

PARAMETER	SYMBOL	CONDITIONS	MIN	TYP	MAX	UNITS
Control Voltage (Low)	$V_{CTL(L)}$	$f=0.01\sim 2.5\text{GHz}$	-0.2	0	0.2	V
Control Voltage (High)	$V_{CTL(H)}$	$f=0.01\sim 2.5\text{GHz}$	2.5	2.8	6.5	V
Control Current	I_{CTL}	$f=0.9\text{GHz}$, $P_{IN}=31\text{dBm}$	-	10	20	μA
Insertion loss 1	LOSS1	$f=0.9\text{GHz}$, $P_{IN}=31\text{dBm}$	-	0.60	0.75	dB
Insertion loss 2	LOSS2	$f=1.9\text{GHz}$, $P_{IN}=25\text{dBm}$	-	0.75	0.90	dB
Isolation 1 (P1-P2, P3-P4, P1-P4 P2-P3, P1-P3, P2-P4)	ISL1	$f=0.9\text{GHz}$, $P_{IN}=31\text{dBm}$	21	23	-	dB
Isolation 2 (P1-P2, P3-P4, P1-P4 P2-P3, P1-P3, P2-P4)	ISL2	$f=0.9\text{GHz}$, $P_{IN}=31\text{dBm}$	16	17	-	dB
Pin at 0.2dB Compression point	$P_{-0.2\text{dB}}$	$f=1.9\text{GHz}$	33.5	36	-	dBm
2nd Harmonics 1	$2fo(1)$	$f=0.9\text{GHz}$, $P_{IN}=25\text{dBm}$	-	-	-70	dBc
2nd Harmonics 2	$2fo(2)$	$f=1.9\text{GHz}$, $P_{IN}=25\text{dBm}$	-	-	-65	dBc
3rd Harmonics 1	$3fo(1)$	$f=0.9\text{GHz}$, $P_{IN}=25\text{dBm}$	-	-	-65	dBc
3rd Harmonics 2	$3fo(2)$	$f=1.9\text{GHz}$, $P_{IN}=25\text{dBm}$	-	-	-65	dBc
Input 3 rd order intercept Point 1	IIP3(1)	$f=900+901\text{MHz}$, $P_{in}=25\text{dBm}$ *1	-	60	-	dBm
Input 3 rd order intercept Point 2	IIP3(2)	$f=1900+1901\text{MHz}$, $P_{in}=25\text{dBm}$ *1	-	60	-	dBm
VSWR	VSWR _i	on-state ports, $f=1.9\text{GHz}$	-	1.2	1.4	
Switching time	T_{SW}	$f=0.1\sim 2.5\text{GHz}$	-	100	-	ns

*1: The input IP3 is defined as following equation.

$$\text{IIP3}=(3 \times P_{out} - \text{IM3}) / 2 + \text{LOSS}$$

■ TERMINAL INFORMATION

No.	SYMBOL	EXPLANATION
1	P1	RF port. This port is connected with P2 port by controlling 2pin- $V_{CTL(H)}$ (+2.5~+6.5V) and 5pin- $V_{CTL(L)}$ (-0.2~+0.2V). This port is connected with P4 port by controlling 2pin- $V_{CTL(L)}$ (-0.2~+0.2V) and 5pin- $V_{CTL(H)}$ (+2.5~+6.5V). A DC cut capacitor 56pF is required at this terminal to block DC voltage of inner circuit.
2	VCTL1	Control port1. Please connect bypass capacitor (10pF) between this terminal and GND close to this IC.
3	VCTL2	Control port2. Please connect bypass capacitor (10pF) between this terminal and GND close to this IC.
4	P2	RF port. This port is connected with P1 port by controlling 2pin- $V_{CTL(L)}$ (-0.2~+0.2V) and 5pin- $V_{CTL(H)}$ (+2.5~+6.5V). This port is connected with P3 port by controlling 2pin- $V_{CTL(H)}$ (+2.5~+6.5V) and 5pin- $V_{CTL(L)}$ (-0.2~+0.2V). A DC cut capacitor 56pF is required at this terminal to block DC voltage of inner circuit.
5	P3	RF port. This port is connected with P2 port by controlling 2pin- $V_{CTL(H)}$ (+2.5~+6.5V) and 5pin- $V_{CTL(L)}$ (-0.2~+0.2V). This port is connected with P4 port by controlling 2pin- $V_{CTL(L)}$ (-0.2~+0.2V) and 5pin- $V_{CTL(H)}$ (+2.5~+6.5V). A DC cut capacitor 56pF is required at this terminal to block DC voltage of inner circuit.
6	P4	RF port. This port is connected with P1 port by controlling 2pin- $V_{CTL(H)}$ (+2.5~+6.5V) and 5pin- $V_{CTL(L)}$ (-0.2~+0.2V). This port is connected with P3 port by controlling 2pin- $V_{CTL(L)}$ (-0.2~+0.2V) and 5pin- $V_{CTL(H)}$ (+2.5~+6.5V). A DC cut capacitor 56pF is required at this terminal to block DC voltage of inner circuit.

NJG1528HD3

ELECTRICAL CHARACTERISTICS

(with application circuit, losses of PCB, connector and DC blocking capacitor are excluded)

P1-P2 Insertion Loss vs. Frequency

(P1-P2/P3-P4 ON, VCTL=0V/2.8V, Pin=-10dBm)

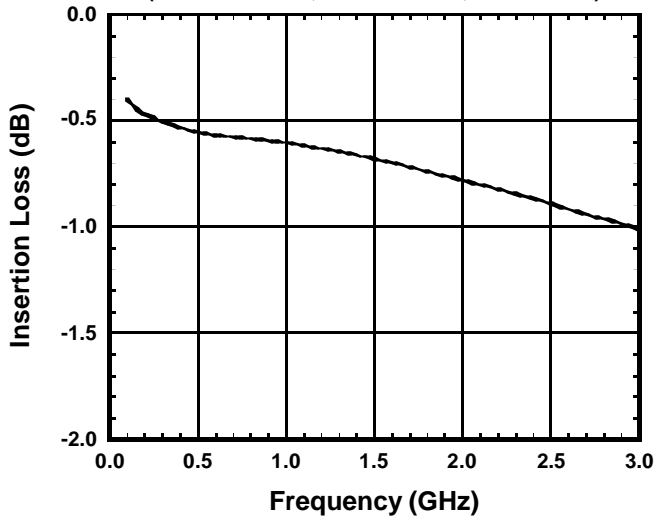

P3-P4 Insertion Loss vs. Frequency

(P1-P2/P3-P4 ON, VCTL=0V/2.8V, Pin=-10dBm)

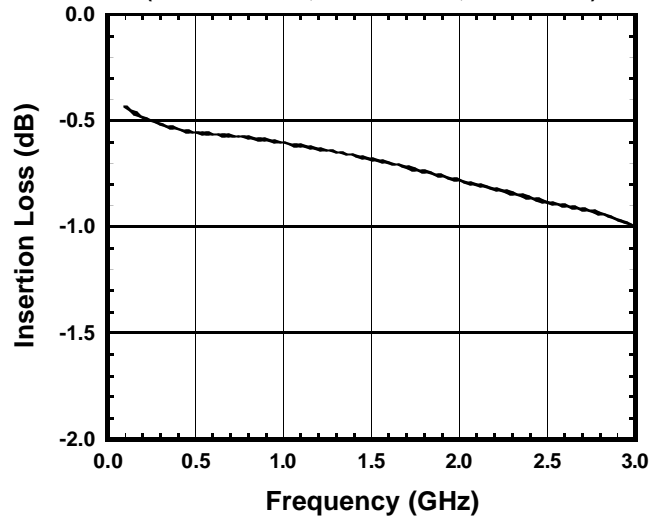

P1-P2 Isolation vs. Frequency

(P1-P4/P3-P2 ON, VCTL=0V/2.8V, Pin=-10dBm)

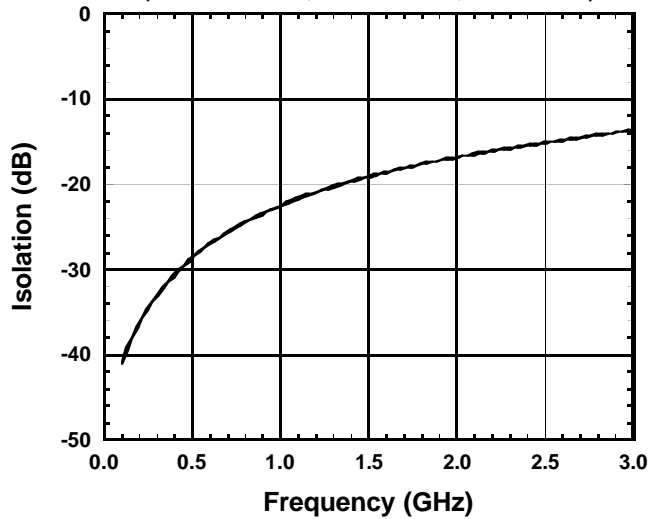

P3-P4 Isolation vs. Frequency

(P1-P4/P3-P2 ON, VCTL=0V/2.8V, Pin=-10dBm)

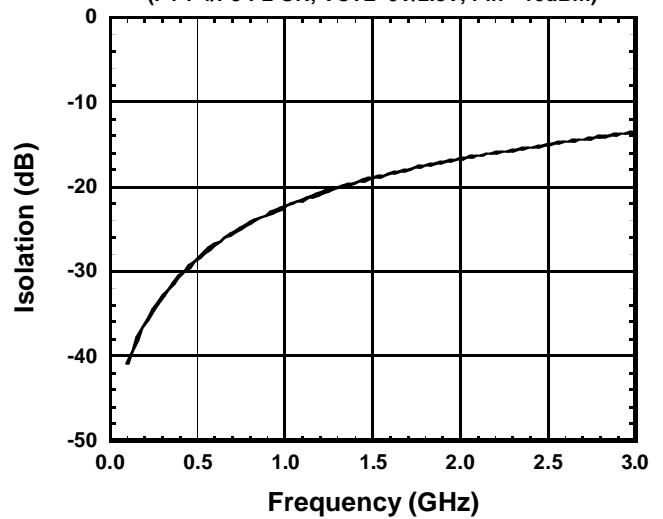

P1-P2 VSWR vs. Frequency

(P1-P2/P3-P4 ON, VCTL=0V/2.8V, Pin=-10dBm)

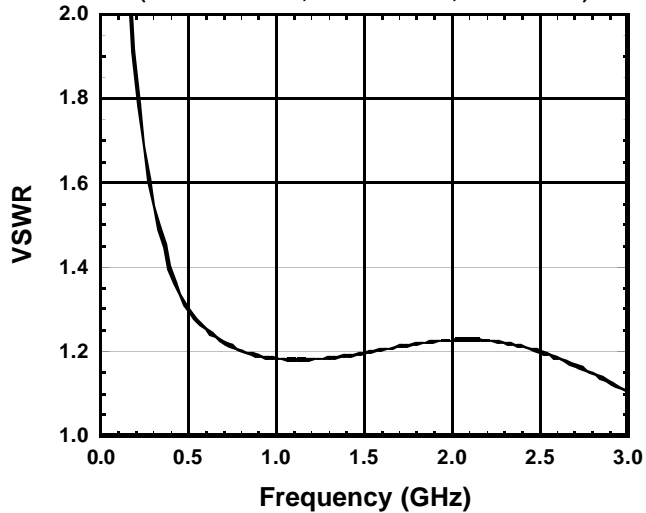

P3-P4 VSWR vs. Frequency

(P1-P2/P3-P4 ON, VCTL=0V/2.8V, Pin=-10dBm)

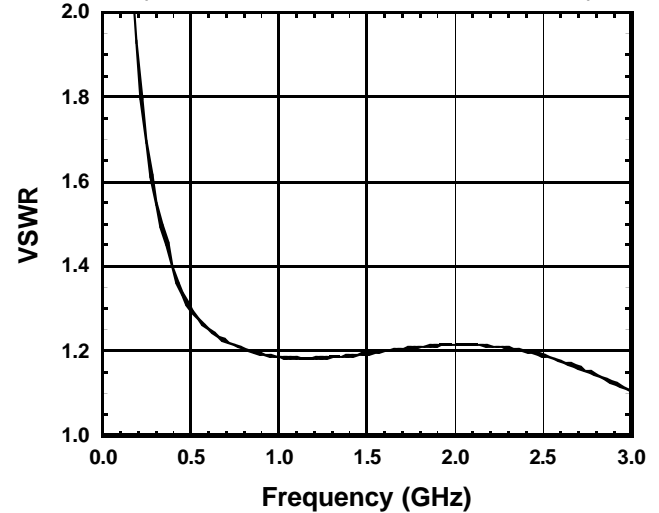

ELECTRICAL CHARACTERISTICS

(with application circuit, losses of PCB, connector and DC blocking capacitor are excluded)

P1-P4 Insertion Loss vs. Frequency

(P1-P4/P3-P2 ON, VCTL=0V/2.8V, Pin=-10dBm)

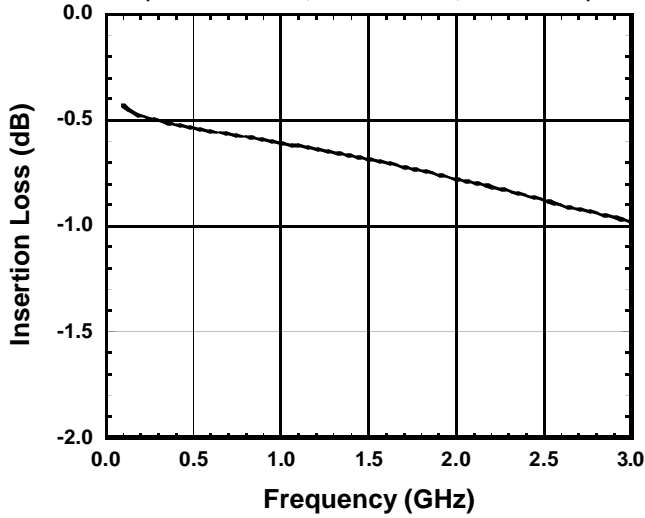

P3-P2 Insertion Loss vs. Frequency

(P1-P4/P3-P2 ON, VCTL=0V/2.8V, Pin=-10dBm)

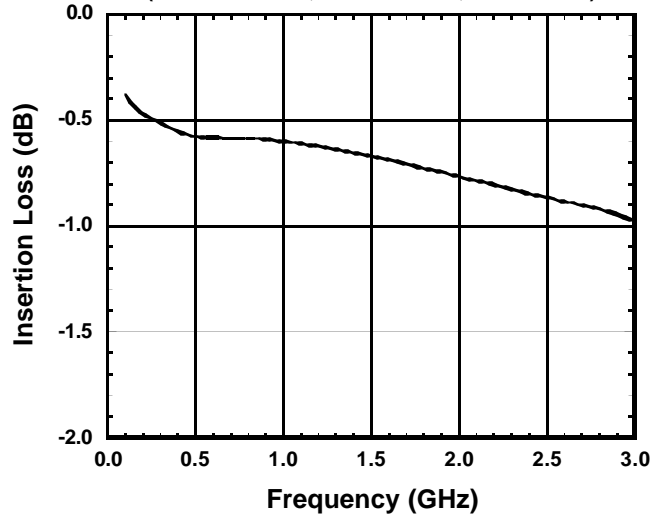

P1-P4 Isolation vs. Frequency

(P1-P2/P3-P4 ON, VCTL=0V/2.8V, Pin=-10dBm)

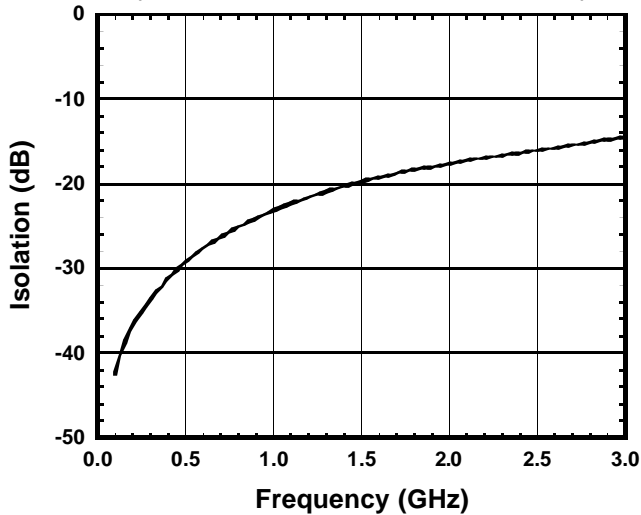

P3-P2 Isolation vs. Frequency

(P1-P2/P3-P4 ON, VCTL=0V/2.8V, Pin=-10dBm)

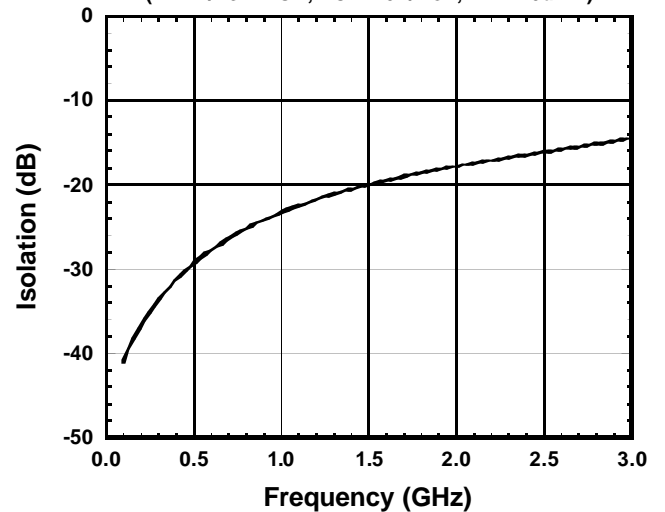

P1-P4 VSWR vs. Frequency

(P1-P4/P3-P2 ON, VCTL=0V/2.8V, Pin=-10dBm)

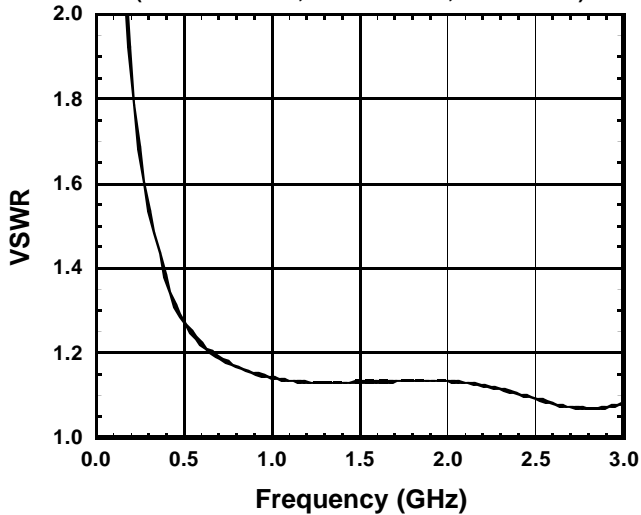

P3-P2 VSWR vs. Frequency

(P1-P4/P3-P2 ON, VCTL=0V/2.8V, Pin=-10dBm)

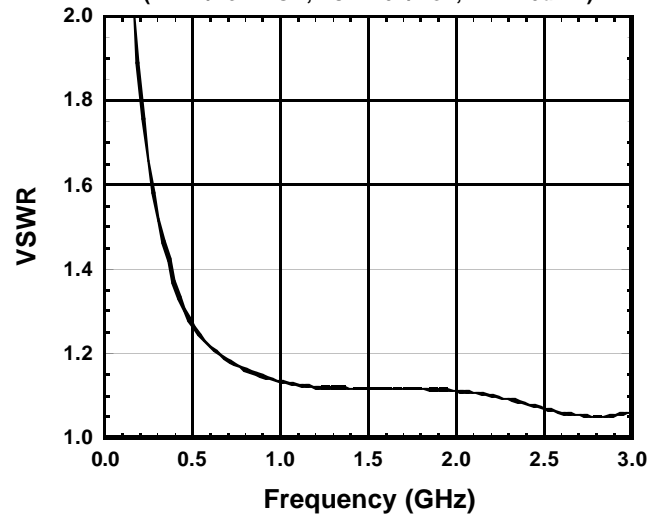

NJG1528HD3

ELECTRICAL CHARACTERISTICS

(with application circuit, losses of PCB, connector and DC blocking capacitor are excluded)

P1-P2 Insertion Loss vs. Input Power

(P1-P2/P3-P4 ON, fin=900MHz)

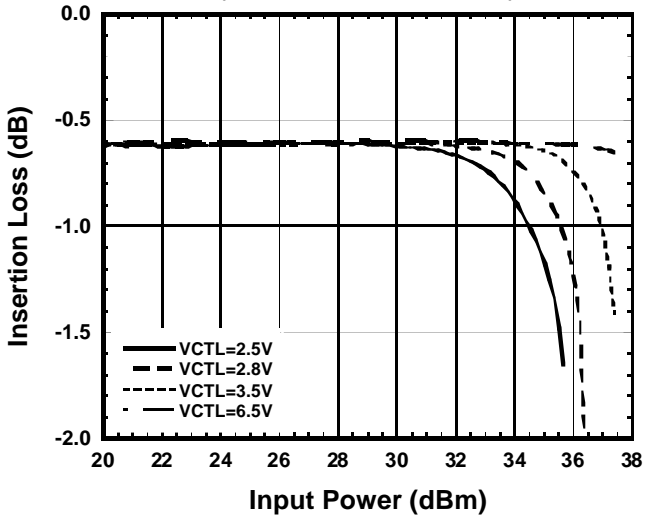

P1-P2 Output Power, ICTL vs. Input Power

(P1-P2/P3-P4 ON, fin=900MHz)

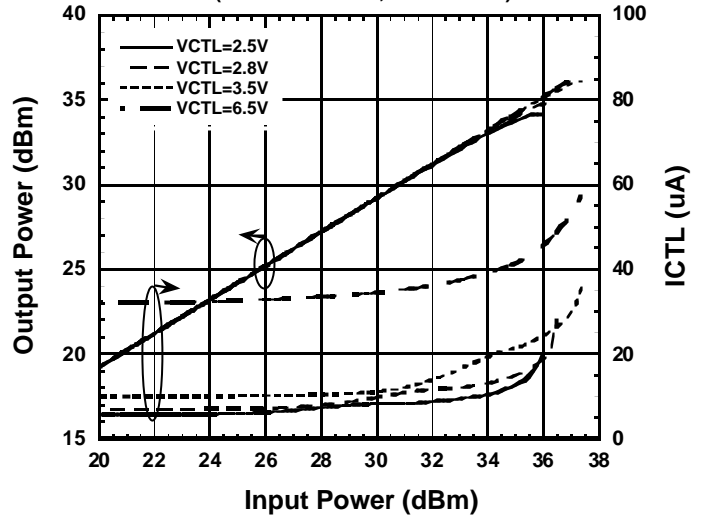

P1-P2 Insertion Loss vs. Input Power

(P1-P2/P3-P4 ON, fin=1.9GHz)

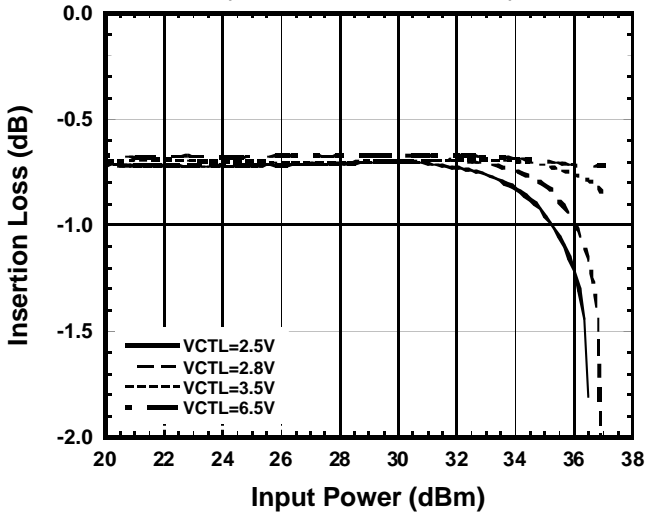

P1-P2 Output Power, ICTL vs. Input Power

(P1-P2/P3-P4 ON, fin=1.9GHz)

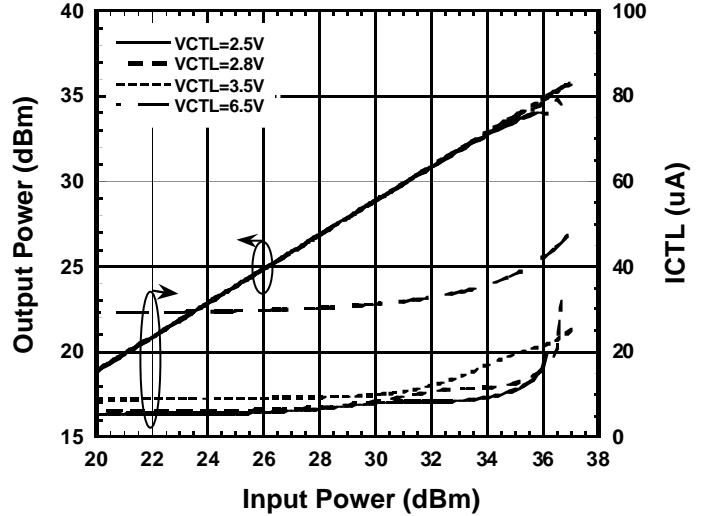

APPLICATION CIRCUIT

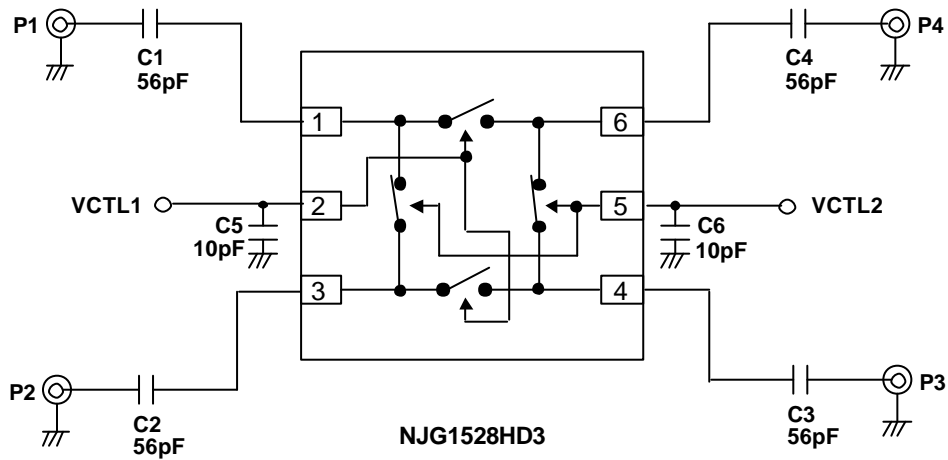

PARTS LIST

Parts No.	f=0.05-0.1GHz	f=0.1-0.5GHz	f=0.5-2.5GHz	Comment
C1 ~ C4	0.01uF	1000pF	56pF	MURATA (GRM36)
C5 ,C6	10pF	10pF	10pF	MURATA (GRM36)

RECOMMENDED PCB DESIGN

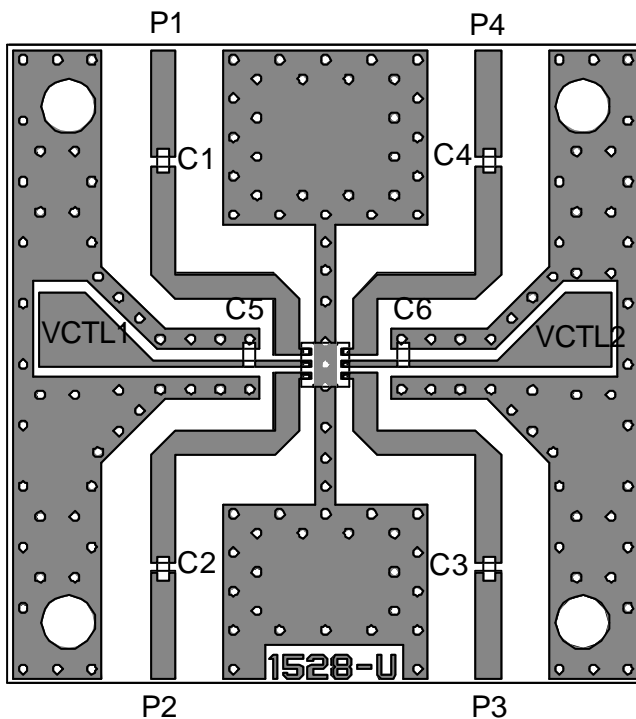

PCB SIZE=26x26mm
 PCB:FR-4 t=0.5mm
 CAPACITOR:size 1005
 MICROSTRIP LINE WIDTH=1.0mm($Z_0=50\text{ohm}$)

NJG1528HD3

■ PACKAGE OUTLINE (USB10-D3)

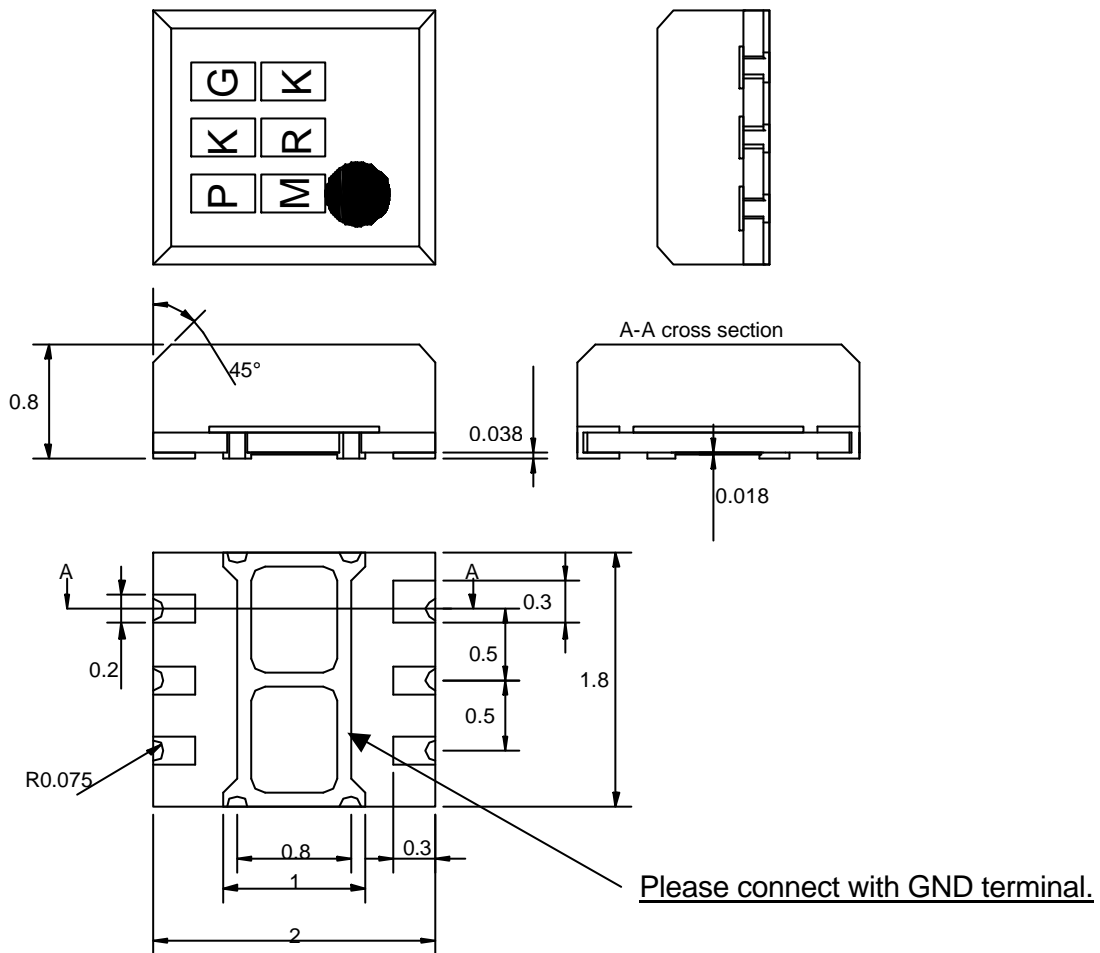

TERMINAL TREAT :Au
 PCB :FR5
 Molding material : Epoxy resin
 UNIT :mm
 WEIGHT :13mg

Cautions on using this product

This product contains Gallium-Arsenide (GaAs) which is a harmful material.

- Do NOT eat or put into mouth.
- Do NOT dispose in fire or break up this product.
- Do NOT chemically make gas or powder with this product.
- To waste this product, please obey the relating law of your country.

[CAUTION]

The specifications on this databook are only given for information, without any guarantee as regards either mistakes or omissions. The application circuits in this databook are described only to show representative usages of the product and not intended for the guarantee or permission of any right including the industrial rights.

This product may be damaged with electric static discharge (ESD) or spike voltage. Please handle with care to avoid these damages.

Mouser Electronics

Authorized Distributor

Click to View Pricing, Inventory, Delivery & Lifecycle Information:

[NJR:](#)

[NJG1528HD3-TE1](#)



Компания «ЭлектроПласт» предлагает заключение долгосрочных отношений при поставках импортных электронных компонентов на взаимовыгодных условиях!

Наши преимущества:

- Оперативные поставки широкого спектра электронных компонентов отечественного и импортного производства напрямую от производителей и с крупнейших мировых складов;
- Поставка более 17-ти миллионов наименований электронных компонентов;
- Поставка сложных, дефицитных, либо снятых с производства позиций;
- Оперативные сроки поставки под заказ (от 5 рабочих дней);
- Экспресс доставка в любую точку России;
- Техническая поддержка проекта, помощь в подборе аналогов, поставка прототипов;
- Система менеджмента качества сертифицирована по Международному стандарту ISO 9001;
- Лицензия ФСБ на осуществление работ с использованием сведений, составляющих государственную тайну;
- Поставка специализированных компонентов (Xilinx, Altera, Analog Devices, Intersil, Interpoint, Microsemi, Aeroflex, Peregrine, Syfer, Eurofarad, Texas Instrument, Miteq, Cobham, E2V, MA-COM, Hittite, Mini-Circuits, General Dynamics и др.);

Помимо этого, одним из направлений компании «ЭлектроПласт» является направление «Источники питания». Мы предлагаем Вам помощь Конструкторского отдела:

- Подбор оптимального решения, техническое обоснование при выборе компонента;
- Подбор аналогов;
- Консультации по применению компонента;
- Поставка образцов и прототипов;
- Техническая поддержка проекта;
- Защита от снятия компонента с производства.



Как с нами связаться

Телефон: 8 (812) 309 58 32 (многоканальный)

Факс: 8 (812) 320-02-42

Электронная почта: org@eplast1.ru

Адрес: 198099, г. Санкт-Петербург, ул. Калинина, дом 2, корпус 4, литера А.