

# PLASTIC CONNECTORS



SERIES



## Precision modular connectors to suit your application

Since its creation in Switzerland in 1946 the LEMO Group has been recognized as a global leader of circular Push-Pull connectors and connector solutions. Today LEMO and its affiliated companies, REDEL and COELVER, are active in more than 80 countries with the help of over 40 subsidiaries and distributors.

### Over 5'000 REDEL connectors



The modular design of the REDEL range provides over 5'000 connectors from  $\varnothing$  14 mm to  $\varnothing$  21 mm, capable of handling cable diameters up to 9.5 mm and up to 32 contacts.

This vast portfolio enables you to select the ideal connector configuration to suit almost any specific requirement in most markets, including medical devices, test and measurement instruments, machinery, audio video broadcast, telecommunications and military.

### REDEL's Push-Pull Self-Latching Connection System

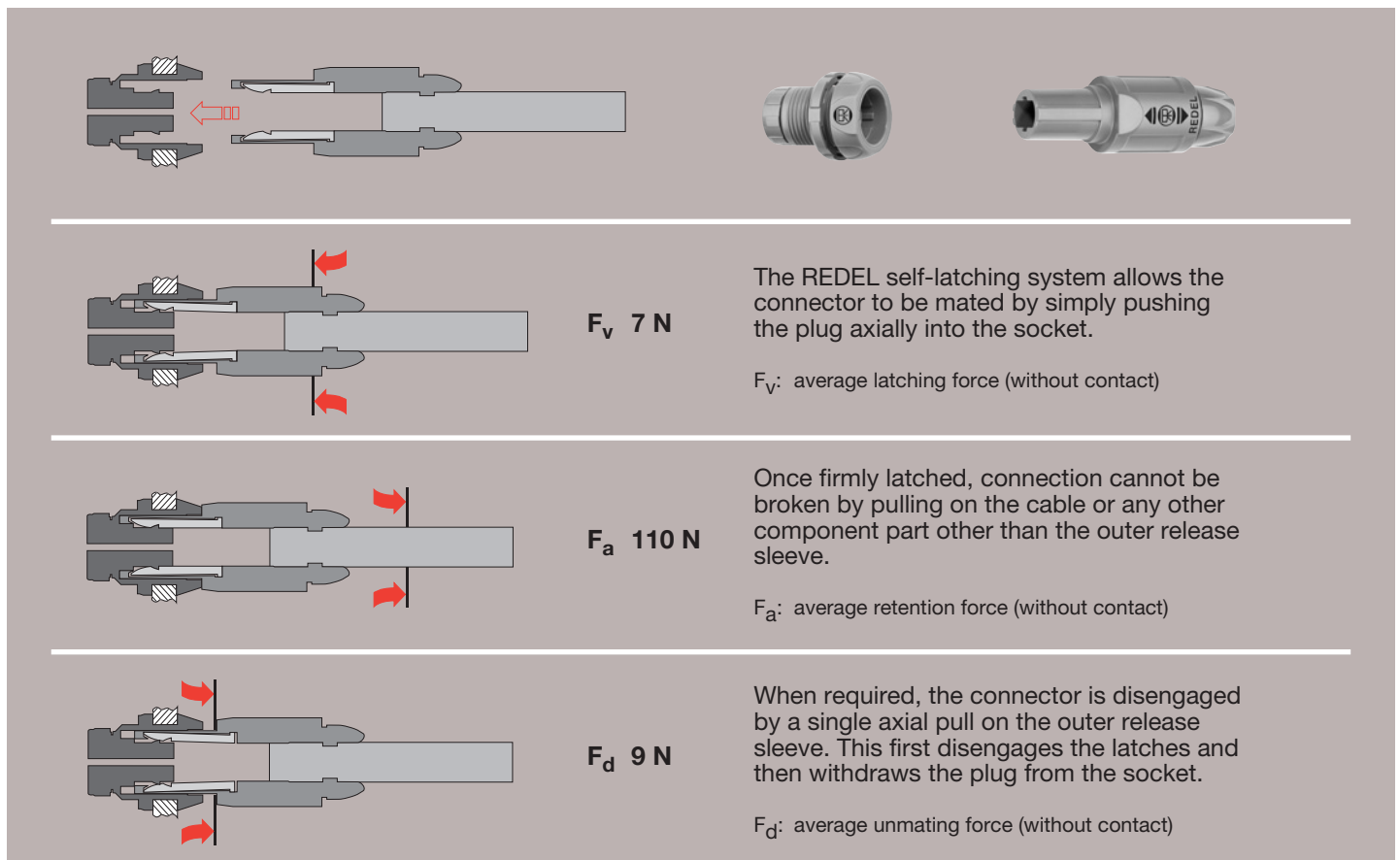
This self-latching system is renowned worldwide for its easy and quick mating and unmating features. It provides absolute security against vibration, shock or pull on the cable, and facilitates operation in a very limited space.

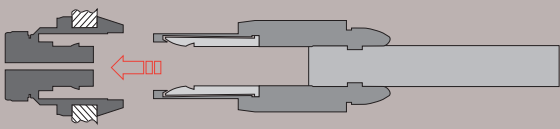

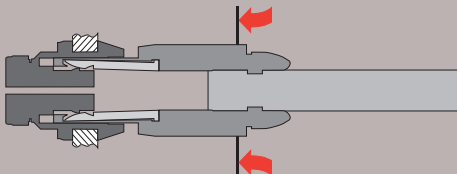
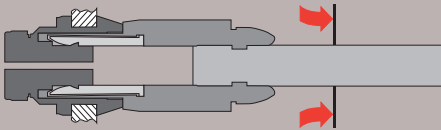
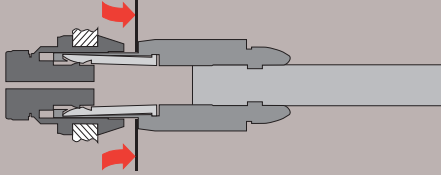
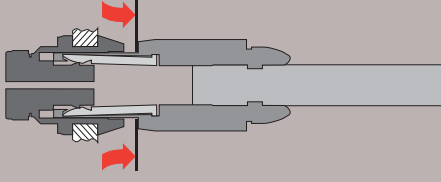
|   |   |   |
|---|---|---|
|    |   |   |
|   | <b><math>F_v</math> 7 N</b>   | <p>The REDEL self-latching system allows the connector to be mated by simply pushing the plug axially into the socket.</p> <p><math>F_v</math>: average latching force (without contact)</p>  |
|  | <b><math>F_a</math> 110 N</b>   | <p>Once firmly latched, connection cannot be broken by pulling on the cable or any other component part other than the outer release sleeve.</p> <p><math>F_a</math>: average retention force (without contact)</p>                                     |
|  | <b><math>F_d</math> 9 N</b>   | <p>When required, the connector is disengaged by a single axial pull on the outer release sleeve. This first disengages the latches and then withdraws the plug from the socket.</p> <p><math>F_d</math>: average unmatting force (without contact)</p> |

### UL Recognition

REDEL connectors are recognized by the Underwriters Laboratories (UL). The approval of the complete system (REDEL connector, cable and your equipment) will be easier because REDEL connectors are recognized.

### CE Marking

CE marking  means that the appliance or equipment bearing it complies with the protection requirements of one or several European safety directives.

CE marking  applies to complete products or equipment, **but not to electromechanical components, such as connectors.**

### RoHS

REDEL connector specifications conforms the requirements of the RoHS directive (2011/65/EU) of the European Parliament and the latest amendments. This directive specifies the restrictions of the use of hazardous substances in electrical and electronic equipment marketed in Europe.

Exploded view of the REDEL SP

Straight plug

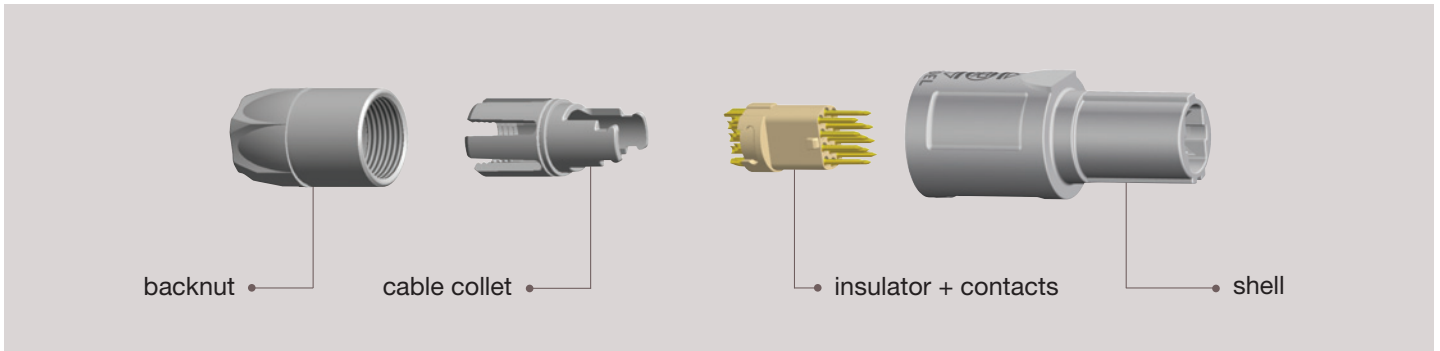

Straight plug with bend relief

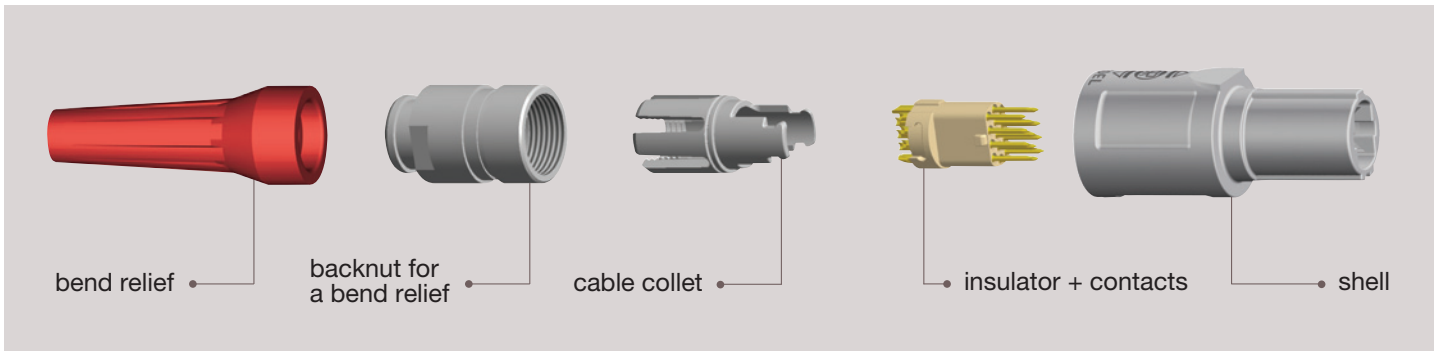

Fixed socket



Free socket



**SP Series**

The REDEL SP connectors are plastic Push-Pull connectors. These circular plastic connectors are especially adapted for applications such as medical electronics and test & measurement. The SP series offer additional features: the latch sleeve is recessed into the connector body ensuring greater shock resistance of the product.

The complete connector can be assembled from spare parts (even the contact configuration) therefore offering good flexibility in stock keeping. The outer shell in Proprietary sulfone enables extensive sterilisation cycles of the product. A large choice of bend relief is available in different colour and size. REDEL SP series connectors are not compatible with the REDEL 1P or 2P series.

**Features & Benefits**

- Plastic shell made of Proprietary sulfone
- Blind mating, scoop proof
- Extended resistance to sterilisation
- Enhanced ergonomics «hand grip»
- Increased resistance to shock
- New patented Push-Pull system

**Applications**

- Medical electronics
- Test & measurement
- Industrial electronics
- Automotive

**Standard models**

**Straight plugs**



SA ●



SA ●

**Fixed sockets**

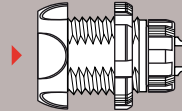

SL ●

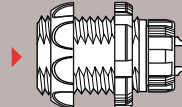

SK ●

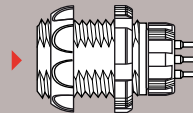

SK ●

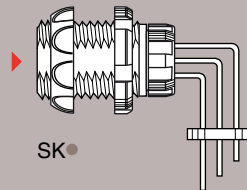

SK ●

**Free sockets**

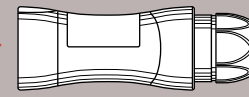

SR ●

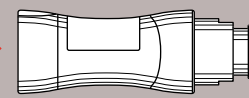

SR ●





Standard models (IP50)



Fixed socket

- 1 Outershell
- 2 Insulator
- 3 Female contact
- 4 Notched nut
- 5 Front nut
- 6 Collet nut



Straight plug

- 1 Outershell
- 2 latch sleeve
- 3 Backnut
- 4 Insulator
- 5 Contact
- 6 Cable collet

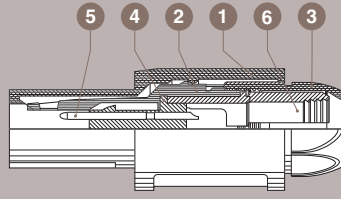

| Characteristics   | Value | Standards            |
|---|-------|----------------------|
| Average retention force when pulling on the cable 1N = 0.102 kg     | 110   | IEC 60512-8 test 15f |
| Cable retention force (depends on cable construction) 1N = 0.102 kg | ~130  | IEC 60512-9 test 17c |

| Characteristics                                 | Value         | Standards           |
|---|---------------|---------------------|
| Endurance (latching)                            | > 2000 cycles | IEC 60512-5 test 9a |
| Working temperature range (Proprietary sulfone) | -50/+170°C    | -                   |

**SAN** Straight plug, key (N) or keys (P, S and T), with cable collet



| Part Number    | Cable ø |     |
|----------------|---------|-----|
|                | min     | max |
| SAN.M●●.GLA.3G | 2.5     | 3.9 |
| SAN.M●●.GLA.5G | 4.0     | 5.2 |
| SAN.M●●.GLA.6G | 5.3     | 6.5 |
| SAN.M●●.GLA.7G | 6.6     | 7.5 |

**Note:** replace ●● by contact configuration (see page 6).

**SAN** Straight plug, key (N) or keys (P, S and T), with cable collet and nut for fitting a bend relief

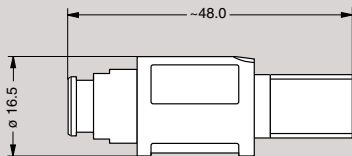

| Part Number     | Cable ø |     |
|-----------------|---------|-----|
|                 | min     | max |
| SAN.M●●.GLA.3GZ | 2.5     | 3.9 |
| SAN.M●●.GLA.5GZ | 4.0     | 5.2 |
| SAN.M●●.GLA.6GZ | 5.3     | 6.5 |
| SAN.M●●.GLA.7GZ | 6.6     | 7.5 |

**Note:** replace ●● by contact configuration (see page 6). The bend relief must be ordered separately (see page 10).

**SLN** Fixed socket, key (N) or keys (P, S and T), nut fixing

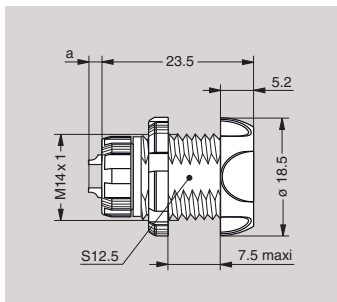

| Part Number  | Contact    |        |
|--------------|------------|--------|
|              | Solder     | Crimp  |
|              | a max (mm) | a (mm) |
| SLN.M●●.GLLG | 2.2        | 0      |

**Note:** replace ●● by contact configuration (see page 6).

**Note:** all dimensions are in millimeters.

**SKN** Fixed socket, key (N) or keys (P, S and T) with two nuts (back panel mounting)



| Part Number  | Contact              |                 |
|--------------|----------------------|-----------------|
|              | Solder<br>a max (mm) | Crimp<br>a (mm) |
| SKN.M●●.GLLG | 2.2                  | 0               |

**Note:** replace ●● by contact configuration (see page 6).

**SKN** Fixed socket, key (N) or keys (P, S and T) with two nuts (back panel mounting) and with straight print contact



| Part Number  |
|--------------|
| SKN.M●●.GLNG |

**Note:** replace ●● by contact configuration (see page 6).

**SKN** Fixed socket, key (N) or keys (P, S and T) with two nuts (back panel mounting) and with elbow print contact



| Part Number  |
|--------------|
| SKN.M●●.GLVG |

**Note:** replace ●● by contact configuration (see page 6).

**SRN** Free socket, key (N) or keys (P, S and T), with cable collet



| Part Number    | Cable ø |     |
|----------------|---------|-----|
|                | min     | max |
| SRN.M●●.GLL.3G | 2.5     | 3.9 |
| SRN.M●●.GLL.5G | 4.0     | 5.2 |
| SRN.M●●.GLL.6G | 5.3     | 6.5 |
| SRN.M●●.GLL.7G | 6.6     | 7.5 |

**Note:** replace ●● by contact configuration (see page 6).

**SRN** Free socket, key (N) or keys (P, S and T), with cable collet and nut for fitting a bend relief



| Part Number     | Cable ø |     |
|-----------------|---------|-----|
|                 | min     | max |
| SRN.M●●.GLL.3GZ | 2.5     | 3.9 |
| SRN.M●●.GLL.5GZ | 4.0     | 5.2 |
| SRN.M●●.GLL.6GZ | 5.3     | 6.5 |
| SRN.M●●.GLL.7GZ | 6.6     | 7.5 |

**Note:** replace ●● by contact configuration (see page 6). The bend relief must be ordered separately (see page 10).

**Note:** all dimensions are in millimeters.

Alignment key

S . M . . . . .

Verify the third digit of the part number in order to select the right keying. The standard keying is «N» coded.

|                          |          |          |          |          |
|--------------------------|----------|----------|----------|----------|
| Keying (plug front view) |          |          |          |          |
|                          | <b>N</b> | <b>P</b> | <b>S</b> | <b>T</b> |
| Reference                |          |          |          |          |
| Contact type for plug    | male     | male     | female   | female   |
| Contact type for socket  | female   | female   | male     | male     |

Insert configuration

S . M . . . . .

|           | Male solder contacts | Female solder contacts | Reference | Number of contacts | Contact ø A (mm) | Solder bucket ø (mm) <sup>4)</sup> | Crimp bucket ø (mm) <sup>4)</sup> | AWG max-min                  | Contact type                      |               | Solder   |  |                   | Crimp  |  |                   |
|-----------|----------------------|------------------------|-----------|--------------------|------------------|------------------------------------|-----------------------------------|------------------------------|-----------------------------------|---------------|--|--|-------------------|--|--|-------------------|
|           |                      |                        |           |                    |                  |                                    |                                   |                              | Solder / Crimp / Print (straight) | Print (elbow) | Test voltage (kV rms) <sup>1)</sup><br>Contact-contact | Air clearance min <sup>2)</sup> (mm)<br>Creepage distance min <sup>3)</sup> (mm) | Rated current (A) | Test voltage (kV rms) <sup>1)</sup><br>Contact-contact | Air clearance min <sup>2)</sup> (mm)<br>Creepage distance min <sup>3)</sup> (mm) | Rated current (A) |
| Multipole |                      |                        | M04       | 4                  | 1.3              | 1.10                               | 1.40                              | 18 <sup>4)</sup><br>20<br>22 | •                                 | •             | 1.60   | 0.95   | 11.5              | 1.80   | 1.35   | 11.5              |
|           |                      |                        | M06       | 6                  | 0.9              | 0.80                               | 1.10                              | 20<br>22<br>24               | •                                 | •             | 1.50   | 1.20   | 8.5               | 1.90   | 1.50   | 8.5               |
|           |                      |                        | M08       | 8                  | 0.9              | 0.80                               | 1.10                              | 20<br>22<br>24               | •                                 | •             | 1.50   | 0.75   | 5.0               | 1.50   | 1.1  | 5.0               |
|           |                      |                        | M10       | 10                 | 0.7              | 0.80                               | 0.80                              | 22 <sup>4)</sup><br>24<br>26 | •                                 | •             | 1.15   | 0.70   | 4.2               | 1.50   | 1.1  | 4.2               |
|           |                      |                        | M13       | 13                 | 0.7              | 0.80                               | 0.80                              | 22 <sup>4)</sup><br>24<br>26 | •                                 | •             | 1.05   | 0.50   | 4.0               | 1.30   | 0.9  | 4.0               |
|           |                      |                        | M16       | 16                 | 0.5              | 0.45                               | 0.45                              | 28<br>30<br>32               | •                                 | -             | 0.75   | 0.47   | 3.0               | 1.30   | 0.8  | 3.0               |
|           |                      |                        | M18       | 18                 | 0.5              | 0.45                               | 0.45                              | 28<br>30<br>32               | •                                 | -             | 0.75   | 0.47   | 2.5               | 1.15   | 0.8  | 2.5               |
|           |                      |                        | M22       | 22                 | 0.5              | 0.45                               | 0.45                              | 28<br>30<br>32               | •                                 | -             | 0.60   | 0.48   | 2.0               | 1.30   | 0.8  | 1.2               |

**Note:** 1) depending on specific application and related standard, more restrictive operating voltage may apply. We suggest operating voltage = 1/3 test voltage, see page 15.

2) shortest distance in air between two conductive parts.

3) shortest distance along the surface of the insulating material between two conductive parts.

4) for a given AWG, the diameter of some stranded conductor design is larger than the solder cup diameter (see page 14).



## Outer shell material S | | | . M | | | . | | | . | | | |

| Material            | Ref. | Colour | Temperature   |
|---------------------|------|--------|---------------|
| Proprietary sulfone | G    | Grey   | -50° / +170°C |
|                     | N    | Black  |               |
|                     | B    | White  |               |

**Note:** adapted for sterilisation saturated steam (120°C or 134°C).

## Contact type S | | | . M | | | . | | | . | | | |

Select the type of contact: solder or crimp?

Plug

| Type   | Male | Female          |
|--------|------|-----------------|
| solder | A    | L <sup>1)</sup> |
| crimp  | C    | M <sup>1)</sup> |

Socket

| Type      | Male            | Female |
|-----------|-----------------|--------|
| solder    | A <sup>1)</sup> | L      |
| crimp     | -               | M      |
| print     | D <sup>1)</sup> | N      |
| print 90° | -               | V      |

**Note:** 1) only for S or T keying.

When should I use crimp rather than solder contacts ?

### Soldering

- recommended for small volumes
- requires little amount of tooling (soldering iron)
- requires more time

### Crimping

- recommended for large volumes
- no heat is required to make the connection
- for contacts with high density
- for use in high temperature environment (max. 170°C)
- requires extra tooling (crimping tools)

## Colour coding S | | | . M | | | . | | | . | | | |

|           | Colours |      |        |       |      |       |       |
|-----------|---------|------|--------|-------|------|-------|-------|
|           | grey    | blue | yellow | black | red  | green | white |
| Reference | G       | A    | J      | N     | R    | V     | B     |
| RAL code  | 7001    | 5015 | 1016   | 9005  | 3020 | 6019  | 9003  |

**Note:** the RAL colours are indicative and depend on raw material and production process. Colour may differ.

Easy identification with the assistance of colour coding. Outershell is only available in grey, black or white.

**Accessories**

**SAN / SLN Insulator and male or female crimp contacts**



| Contact configuration | nb. of contacts | ø contact (mm) | Kit contact part number | Kit contact part number |
|-----------------------|-----------------|----------------|-------------------------|-------------------------|
|                       |                 |                | Male                    | Female                  |
| M04                   | 4               | 1.3            | SAN.M04.ZLC             | SLN.M04.ZLM             |
| M06                   | 6               | 0.9            | SAN.M06.ZLC             | SLN.M06.ZLM             |
| M08                   | 8               | 0.9            | SAN.M08.ZLC             | SLN.M08.ZLM             |
| M10                   | 10              | 0.7            | SAN.M10.ZLC             | SLN.M10.ZLM             |
| M13                   | 13              | 0.7            | SAN.M13.ZLC             | SLN.M13.ZLM             |
| M16                   | 16              | 0.5            | SAN.M16.ZLC             | SLN.M16.ZLM             |
| M18                   | 18              | 0.5            | SAN.M18.ZLC             | SLN.M18.ZLM             |
| M22                   | 22              | 0.5            | SAN.M22.ZLC             | SLN.M22.ZLM             |

**SAN / SLN Insulator with male or female solder contacts**



| Contact configuration | nb. of contacts | ø contact (mm) | Kit contact part number | Kit contact part number |
|-----------------------|-----------------|----------------|-------------------------|-------------------------|
|                       |                 |                | Male                    | Female                  |
| M04                   | 4               | 1.3            | SAN.M04.ZLA             | SLN.M04.ZLL             |
| M06                   | 6               | 0.9            | SAN.M06.ZLA             | SLN.M06.ZLL             |
| M08                   | 8               | 0.9            | SAN.M08.ZLA             | SLN.M08.ZLL             |
| M10                   | 10              | 0.7            | SAN.M10.ZLA             | SLN.M10.ZLL             |
| M13                   | 13              | 0.7            | SAN.M13.ZLA             | SLN.M13.ZLL             |
| M16                   | 16              | 0.5            | SAN.M16.ZLA             | SLN.M16.ZLL             |
| M18                   | 18              | 0.5            | SAN.M18.ZLA             | SLN.M18.ZLL             |
| M22                   | 22              | 0.5            | SAN.M22.ZLA             | SLN.M22.ZLL             |

**SA●.100.●ZZ Plug outershell kit (no contacts)**



| Part Number | Colours |
|-------------|---------|
| SA●.100.GZZ | grey    |
| SA●.100.BZZ | white   |
| SA●.100.NZZ | black   |

**Note:** replace ● by alignment key (N, P, S or T).

**SR●.200.●● Free socket outershell kit (no contacts)**



| Part Number | Colours |
|-------------|---------|
| SR●.200.RG  | grey    |
| SR●.200.RB  | white   |
| SR●.200.RN  | black   |

**Note:** replace ● by alignment key (N, P, S or T).

**SL●.200.●ZZ Socket outershell kit (nut fixing), (no contacts)**

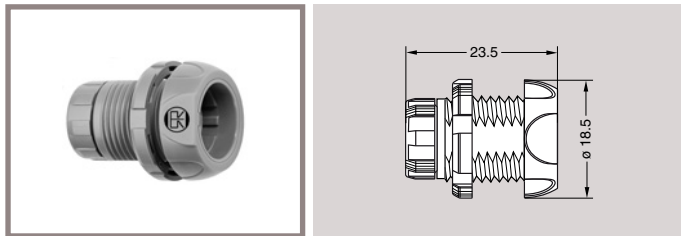

| Part Number  | Colours |
|--------------|---------|
| SL●.200.GZZG | grey    |
| SL●.200.BZZB | white   |
| SL●.200.NZZN | black   |

**Note:** replace ● by alignment key (N, P, S or T).

**SK●.200.●ZZ●** Socket outershell kit (with two nuts), (no contacts)



| Part Number  | Colours |
|--------------|---------|
| SK●.200.GZZG | grey    |
| SK●.200.BZZB | white   |
| SK●.200.NZZN | black   |

**Note:** replace ● by alignment key (N, P, S or T).

**SAN** Collet

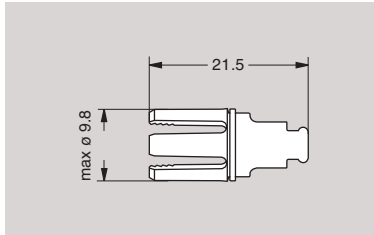

| Part Number | Cable $\phi$ (mm) |      |
|-------------|-------------------|------|
|             | min.              | max. |
| SAN.739.RG  | 2.5               | 3.9  |
| SAN.752.RG  | 4.0               | 5.2  |
| SAN.765.RG  | 5.3               | 6.5  |
| SAN.775.RG  | 6.6               | 7.5  |

**SAM.130.●●** Nut for fitting a GMA.1B bend relief

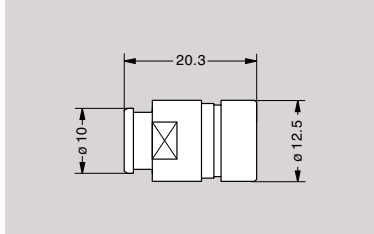

| Part Number | Colours |
|-------------|---------|
| SAM.130.RG  | grey    |
| SAM.130.RB  | white   |
| SAM.130.RN  | black   |

**Note:** only for SA●, SR● models.

**SAN.130.●●** Collet nut

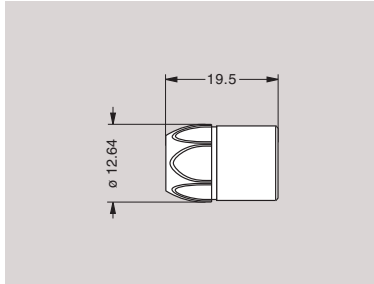

| Part Number | Colours |
|-------------|---------|
| SAN.130.RG  | grey    |
| SAN.130.RB  | white   |
| SAN.130.RR  | red     |
| SAN.130.RN  | black   |
| SAN.130.RJ  | yellow  |
| SAN.130.RA  | blue    |
| SAN.130.RV  | green   |

**Note:** only for SA●, SR● models.

**SLN** Notched nut

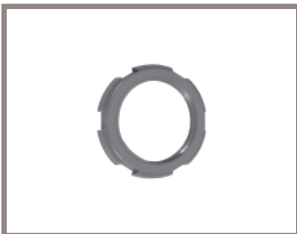

| Part Number | Colours |
|-------------|---------|
| SLN.240.RG  | grey    |

**SLN** Collet nut



| Part Number | Colours |
|-------------|---------|
| SLN.230.RG  | grey    |

**Note:** all dimensions are in millimeters.

**SLN** Plastic front nut for SL● models



| Part Number | Colours |
|-------------|---------|
| SLN.220.RG  | grey    |
| SLN.220.RB  | white   |
| SLN.220.RR  | red     |
| SLN.220.RN  | black   |
| SLN.220.RJ  | yellow  |
| SLN.220.RA  | blue    |
| SLN.220.RV  | green   |

**SKN** Plastic front nut for SK● models

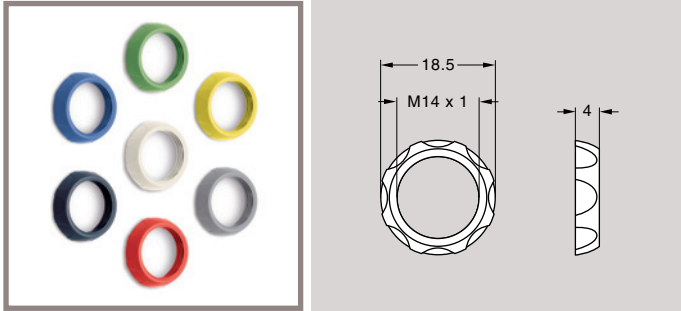

| Part Number | Colours |
|-------------|---------|
| SKN.220.RG  | grey    |
| SKN.220.RB  | white   |
| SKN.220.RR  | red     |
| SKN.220.RN  | black   |
| SKN.220.RJ  | yellow  |
| SKN.220.RA  | blue    |
| SKN.220.RV  | green   |

**GMA.1B** Bend relief



A bend relief absorbs the angular force that may be exerted on cables.

These are designed for plugs and free sockets with cable collet and nut.

The Colours of these bend reliefs are not identical to the RAL colours of the socket's front nut.

| Part Number   | Dimensions (mm) |    |         |      | Material                            | Temperature range |                |
|---------------|-----------------|----|---------|------|-------------------------------------|-------------------|----------------|
|               | Bend relief     |    | Cable ø |      |                                     | in dry atmosphere | in water steam |
|               | A               | L  | max.    | min. |                                     |                   |                |
| GMA.1B.025.DG | 2.5             | 30 | 2.9     | 2.5  | TPU<br>(Thermoplastic Polyurethane) | -40°C, +80°C      | -              |
| GMA.1B.030.DG | 3.0             | 30 | 3.4     | 3.0  |                                     |                   |                |
| GMA.1B.035.DG | 3.5             | 30 | 3.9     | 3.5  |                                     |                   |                |
| GMA.1B.040.DG | 4.0             | 30 | 4.4     | 4.0  |                                     |                   |                |
| GMA.1B.045.DG | 4.5             | 30 | 4.9     | 4.5  |                                     |                   |                |
| GMA.1B.054.DG | 5.4             | 30 | 6.0     | 5.4  |                                     |                   |                |
| GMA.1B.065.DG | 6.5             | 30 | 7.0     | 6.5  |                                     |                   |                |
| GMA.1B.025.RG | 2.5             | 34 | 2.9     | 2.5  | Silicone elastomer<br>VMQ           | -60°C, +200°C     | +140°C         |
| GMA.1B.030.RG | 3.0             | 34 | 3.4     | 3.0  |                                     |                   |                |
| GMA.1B.035.RG | 3.5             | 34 | 3.9     | 3.5  |                                     |                   |                |
| GMA.1B.040.RG | 4.0             | 34 | 4.4     | 4.0  |                                     |                   |                |
| GMA.1B.045.RG | 4.5             | 34 | 5.0     | 4.5  |                                     |                   |                |
| GMA.1B.051.RG | 5.1             | 34 | 5.6     | 5.1  |                                     |                   |                |
| GMA.1B.057.RG | 5.7             | 34 | 6.2     | 5.7  |                                     |                   |                |
| GMA.1B.063.RG | 6.3             | 34 | 7.0     | 6.3  |                                     |                   |                |

| Reference | Colours |
|-----------|---------|
| A         | blue    |
| B         | white   |
| G         | grey    |
| J         | yellow  |
| M         | brown   |
| N         | black   |
| R         | red     |
| S         | orange  |
| V         | green   |

**Note:** the selection of pigments, which should remain stable at high temperature, is limited by the new regulations. For this reason, some colours will be a shade different from those used for TPU bend reliefs. The selected solutions represent the best possible compromise.

**Note:** the last letter «G» of the part number indicates a grey colour, see the adjacent table and replace letter «G» by the letter of the colour required. All dimensions are in millimeters.

## Tooling

**SOP.019.HN** Spanners with notch for securing the notched nut



Material: Black polyamide. For notched nut SLN.240.RG.

**SOB.186.GN** Spanners for nut SLN.220R●  
**SOB.187.GN** Spanners for nut SKN.220R●



Material: Black polyamide

**DPC.91.701.V** Crimping tool



**SOE** Positioners for crimp contacts

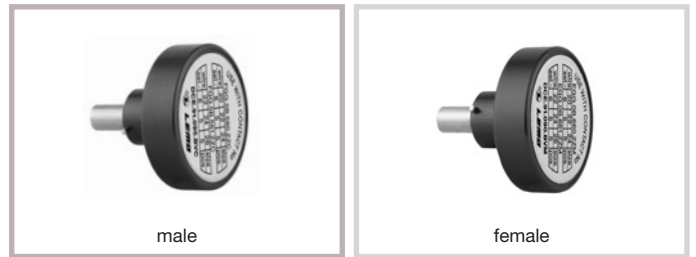

**DCF** Automatic extraction tools for crimp contacts



| Configuration | Contact $\phi$ (mm) | Conductor AWG | Positioner part number |                | Selector No Setting | Part number extractor        |                              |
|---------------|---------------------|---------------|------------------------|----------------|---------------------|------------------------------|------------------------------|
|               |                     |               | Male contact           | Female contact |                     | Male contact                 | Female contact               |
| M04           | 1.3                 | 18-20         | SOE.130.VC             | SOE.130.VM     | 8-7                 | DCF.93.131.4LT               | DCF.93.131.4LT               |
| M06/M08       | 0.9                 | 20-22-24      | SOE.090.VC             | SOE.090.VM     | 6-5-5               | DCF.93.090.4LT               | DCF.93.090.4LT               |
| M10/M13       | 0.7                 | 22-24-26      | SOE.070.VC             | SOE.070.VM     | 6-5-5               | DCF.93.070.4LT               | DCF.93.070.4LT               |
| M16/M18/M22   | 0.5                 | 28-30-32      | SOE.050.VC             | SOE.050.VM     | 4-3-3               | DCF.91.050.2LT <sup>1)</sup> | DCF.91.050.2LT <sup>1)</sup> |

**Note:** the variance in conductor stranding diameter for the minimum AWG is such that some can have a cross section which is not sufficient to guarantee crimping as per IEC 60352-2 standard. 1) With this extractor, the user must remove the insulator from the outer shell.

**DCK** Retention testing tools for crimp contacts

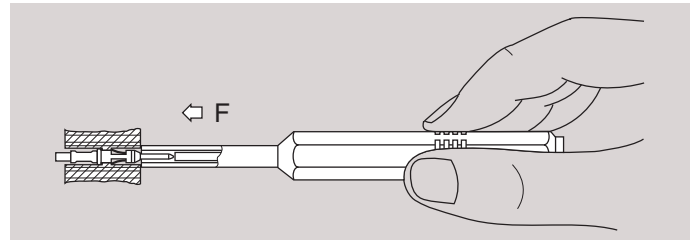

| Contact $\phi$ (mm) | Test force (N) | Testing tool part number |                 |
|---------------------|----------------|--------------------------|-----------------|
|                     |                | Male contact             | Female contact  |
| 0.5                 | 8              | DCK.91.050.8LRC          | DCK.91.050.8LRM |
| 0.7                 | 10             | DCK.91.071.0LRC          | DCK.91.071.0LRM |
| 0.9                 | 14             | DCK.91.091.4LRC          | DCK.91.091.4LRM |
| 1.3                 | 25             | DCK.91.132.5LRC          | DCK.91.132.5LRM |

**Note:** all dimensions are in millimeters

**Panel hole**

For SL● and SK●

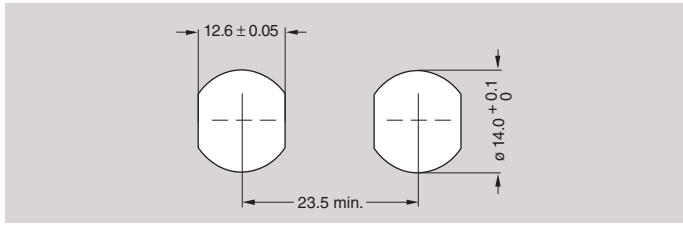

**Note:** Socket mounting nut torque = 1 Nm.  
All dimensions are in millimeters.

**PCB drilling pattern**

For straight contacts

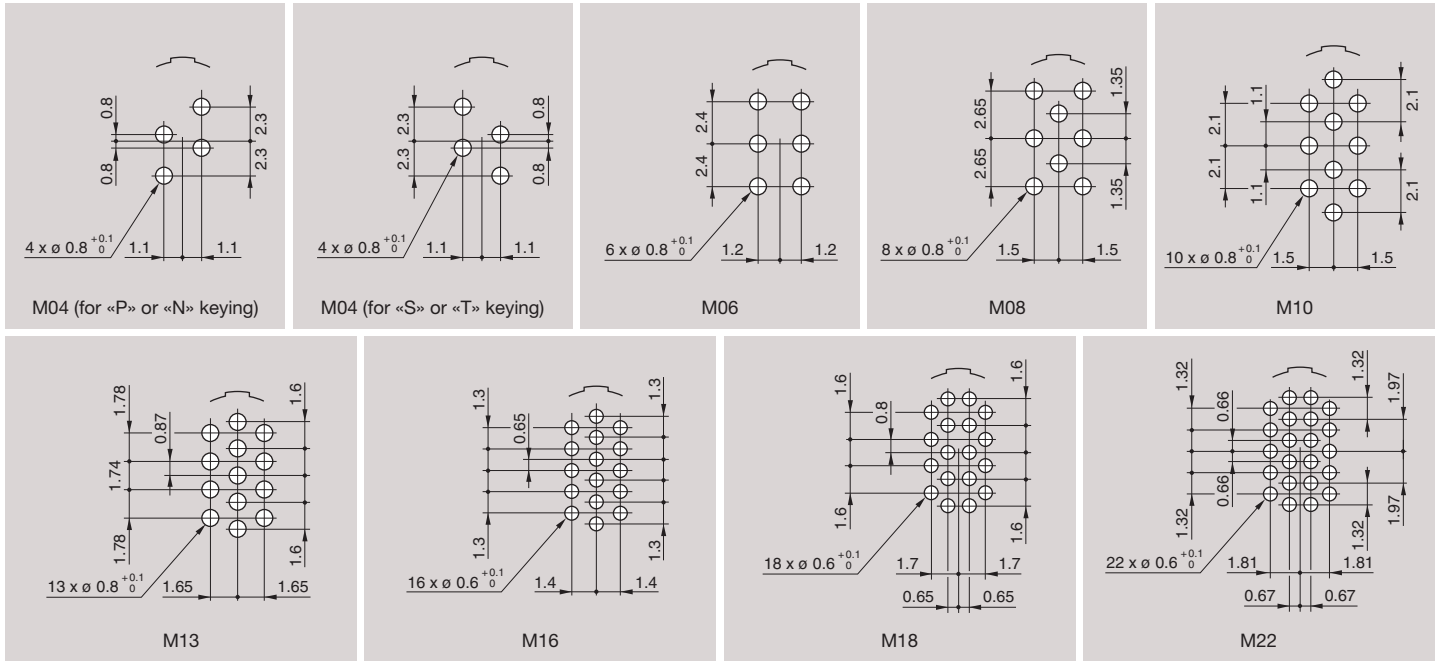

For elbow contacts

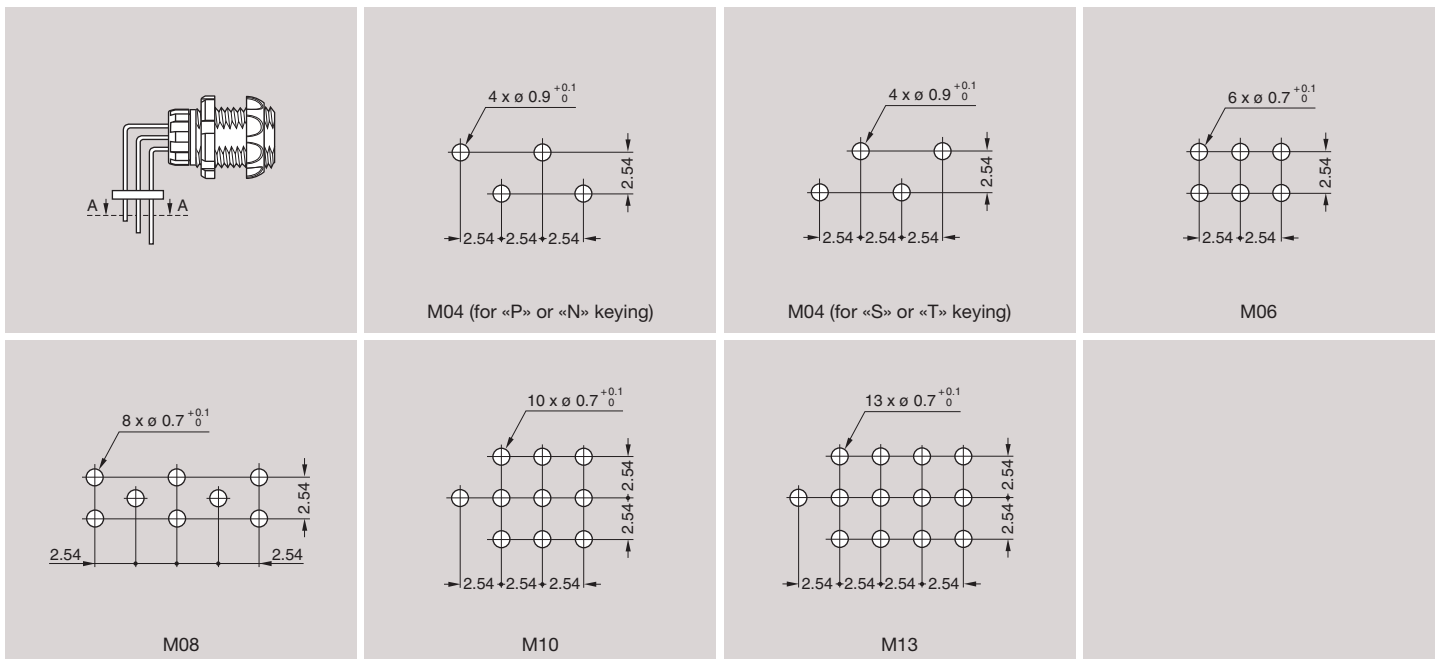

**Note:** all dimensions are in millimeters



# Assembly instructions

## Solder contacts / Crimp contacts



1. Slide the collet nut ① and then the collet ② onto the cable.

| Configuration | Dimensions (mm) |     |                |     |
|---------------|-----------------|-----|----------------|-----|
|               | Solder contacts |     | Crimp contacts |     |
|               | L               | T   | L              | T   |
| M04           | 11.5            | 3.5 | 15.0           | 3.5 |
| M06, M08      | 13.0            | 3.0 | 15.0           | 3.5 |
| M10, M13      | 13.0            | 3.0 | 15.0           | 3.5 |
| M16 to M22    | 12.5            | 2.5 | 14.5           | 2.5 |

2. Strip the cable according to the lengths given in the table. Tin the conductors.

3. Solder conductors into contacts, starting with the center contacts, making sure that neither solder nor flux gets onto the insulator or cable insulation.

Fix the appropriate positioner in the crimping tool. Set selector to the number corresponding to the conductor AWG as indicated on the positioner label. Fit conductor into contact and make sure it is visible through the inspection hole in the crimp barrel. Slide conductor-contact combination into the open crimping tool; make sure that the contact is fully pushed into the positioner. Close the tool. Remove from crimping tool and check that conductor is secure in contact and shows in inspection hole.

4. Slide the collet ② forward and locate both tags ③ in the slots ⑤ on the insulator ⑥. Push collet ② and insulator ⑥ assembly into the shell ⑦ whilst turning it to ensure that the tag ③ locates in the inside slot of the shell.

5. Slide collet nut ① over collet ② and tighten the collet nut ① to the maximum torque of 0.3 Nm.

– Socket mounting nut torque = 1 Nm.

## Technical tables

**Table of American Wire Gauge**

| AWG              | Construction |            | ø wire max |       | Wire section       |                      |
|------------------|--------------|------------|------------|-------|--------------------|----------------------|
|                  | Strand nb    | AWG/strand | (mm)       | (in)  | (mm <sup>2</sup> ) | (sq in)              |
| 0                | 259          | 24         | 11.277     | 0.444 | 52.90              | 0.0820               |
| 1                | 817          | 30         | 9.702      | 0.382 | 41.40              | 0.0641               |
| 2                | 259          | 26         | 8.89       | 0.35  | 33.20              | 0.0514               |
| 4                | 133          | 25         | 6.9596     | 0.274 | 21.5925            | 0.0335               |
| 6                | 133          | 27         | 5.5118     | 0.217 | 13.5885            | 0.0211               |
| 8                | 168          | 30         | 4.4450     | 0.175 | 8.5127             | 0.0132               |
| 8                | 133          | 29         | 4.3942     | 0.173 | 8.6053             | 0.0133               |
| 10               | 105          | 30         | 3.3020     | 0.13  | 5.3204             | 0.0082               |
| 10               | 37           | 26         | 2.9210     | 0.115 | 4.7397             | 0.0073               |
| 10               | 1            | 10         | 2.6162     | 0.103 | 5.2614             | 0.0082               |
| 12               | 37           | 28         | 2.3114     | 0.091 | 2.9765             | 0.0046               |
| 12               | 19           | 25         | 2.3622     | 0.093 | 3.0847             | 0.0048               |
| 12 <sup>1)</sup> | 7            | 20         | 2.5400     | 0.10  | 3.6321             | 0.0056               |
| 12               | 1            | 12         | 2.0828     | 0.082 | 3.3081             | 0.0051               |
| 14               | 41           | 30         | 2.0574     | 0.081 | 2.0775             | 0.0032               |
| 14               | 19           | 27         | 1.8542     | 0.073 | 1.9413             | 0.0030               |
| 14 <sup>1)</sup> | 7            | 22         | 2.0828     | 0.082 | 2.2704             | 0.0035               |
| 14               | 1            | 14         | 1.6510     | 0.065 | 2.0820             | 0.0032               |
| 16 <sup>1)</sup> | 65           | 34         | 1.5748     | 0.062 | 1.3072             | 0.0020               |
| 16               | 26           | 30         | 1.5748     | 0.062 | 1.3174             | 0.0020               |
| 16               | 19           | 29         | 1.4986     | 0.059 | 1.2293             | 0.0019               |
| 16 <sup>1)</sup> | 7            | 24         | 1.5494     | 0.061 | 1.4330             | 0.0022               |
| 16               | 1            | 16         | 1.3208     | 0.052 | 1.3076             | 0.0020               |
| 18 <sup>1)</sup> | 65           | 36         | 1.2700     | 0.05  | 0.8234             | 0.0013               |
| 18 <sup>1)</sup> | 42           | 34         | 1.2700     | 0.05  | 0.8447             | 0.0013               |
| 18               | 19           | 30         | 1.3208     | 0.052 | 0.9627             | 0.0015               |
| 18               | 16           | 30         | 1.2954     | 0.051 | 0.8107             | 0.0013               |
| 18               | 7            | 26         | 1.2700     | 0.05  | 0.8967             | 0.0014               |
| 18               | 1            | 18         | 1.0414     | 0.041 | 0.8229             | 0.0013               |
| 20 <sup>1)</sup> | 42           | 36         | 1.0160     | 0.04  | 0.5320             | 8.2x10 <sup>-4</sup> |
| 20               | 19           | 32         | 1.0414     | 0.041 | 0.6162             | 0.0010               |
| 20               | 10           | 30         | 1.0160     | 0.04  | 0.5067             | 7.9x10 <sup>-4</sup> |
| 20               | 7            | 28         | 0.9906     | 0.039 | 0.5631             | 8.7x10 <sup>-4</sup> |
| 20               | 1            | 20         | 0.8382     | 0.033 | 0.5189             | 8.0x10 <sup>-4</sup> |
| 22               | 19           | 34         | 0.8382     | 0.033 | 0.3821             | 5.9x10 <sup>-4</sup> |
| 22               | 7            | 30         | 0.7874     | 0.031 | 0.3547             | 5.5x10 <sup>-4</sup> |
| 22               | 1            | 22         | 0.6604     | 0.026 | 0.3243             | 5.0x10 <sup>-4</sup> |
| 24 <sup>1)</sup> | 42           | 40         | 0.6604     | 0.026 | 0.2045             | 3.2x10 <sup>-4</sup> |
| 24               | 19           | 36         | 0.6858     | 0.027 | 0.2407             | 3.7x10 <sup>-4</sup> |
| 24               | 7            | 32         | 0.6350     | 0.025 | 0.2270             | 3.5x10 <sup>-4</sup> |
| 24               | 1            | 24         | 0.5588     | 0.022 | 0.2047             | 3.2x10 <sup>-4</sup> |
| 26               | 19           | 38         | 0.5588     | 0.022 | 0.1540             | 2.4x10 <sup>-4</sup> |
| 26               | 7            | 34         | 0.5080     | 0.02  | 0.1408             | 2.2x10 <sup>-4</sup> |
| 26               | 1            | 26         | 0.4318     | 0.017 | 0.1281             | 2.0x10 <sup>-4</sup> |
| 28 <sup>1)</sup> | 19           | 40         | 0.4318     | 0.017 | 0.0925             | 1.4x10 <sup>-4</sup> |
| 28               | 7            | 36         | 0.4064     | 0.016 | 0.0887             | 1.4x10 <sup>-4</sup> |
| 28               | 1            | 28         | 0.3302     | 0.013 | 0.0804             | 1.2x10 <sup>-4</sup> |
| 30               | 7            | 38         | 0.3302     | 0.013 | 0.0568             | 8.8x10 <sup>-5</sup> |
| 30               | 1            | 30         | 0.2794     | 0.011 | 0.0507             | 7.9x10 <sup>-5</sup> |
| 32               | 7            | 40         | 0.2794     | 0.011 | 0.0341             | 5.3x10 <sup>-5</sup> |
| 32               | 1            | 32         | 0.2286     | 0.009 | 0.0324             | 5.0x10 <sup>-5</sup> |
| 34               | 1            | 34         | 0.1693     | 0.007 | 0.0201             | 3.1x10 <sup>-5</sup> |
| 36               | 1            | 36         | 0.127      | 0.005 | 0.0127             | 2.0x10 <sup>-5</sup> |
| 38               | 1            | 38         | 0.1016     | 0.004 | 0.0081             | 1.3x10 <sup>-5</sup> |
| 40               | 1            | 40         | 0.078      | 0.003 | 0.0049             | 7.5x10 <sup>-6</sup> |

**Table of wire gauges according to IEC-60228 standard**

| Conductor no x ø (mm) | Max ø (mm) | Max ø (in) | Section (mm <sup>2</sup> ) | Section (sq in)      |
|-----------------------|------------|------------|----------------------------|----------------------|
| 196x0.40              | 7.50       | 0.295      | 25.00                      | 0.0387               |
| 7x2.14                | 6.10       | 0.240      | 25.00                      | 0.0387               |
| 125x0.40              | 6.00       | 0.236      | 16.00                      | 0.0248               |
| 7x1.72                | 4.90       | 0.192      | 16.00                      | 0.0248               |
| 1x4.50                | 4.50       | 0.177      | 16.00                      | 0.0248               |
| 80x0.40               | 4.70       | 0.155      | 10.00                      | 0.0155               |
| 7x1.38                | 3.95       | 0.155      | 10.00                      | 0.0155               |
| 1x3.60                | 3.60       | 0.141      | 10.00                      | 0.0155               |
| 84x0.30               | 3.70       | 0.145      | 6.00                       | 0.0093               |
| 7x1.50                | 3.15       | 0.124      | 6.00                       | 0.0093               |
| 1x2.76                | 2.76       | 0.108      | 6.00                       | 0.0093               |
| 56x0.30               | 2.80       | 0.110      | 4.00                       | 0.0062               |
| 7x0.86                | 2.58       | 0.098      | 4.00                       | 0.0062               |
| 1x2.25                | 2.25       | 0.082      | 4.00                       | 0.0062               |
| 50x0.25               | 2.15       | 0.084      | 2.50                       | 0.0038               |
| 7x0.68                | 2.04       | 0.080      | 2.50                       | 0.0038               |
| 1x1.78                | 1.78       | 0.070      | 2.50                       | 0.0038               |
| 30x0.25               | 1.60       | 0.062      | 1.50                       | 0.0023               |
| 7x0.52                | 1.56       | 0.061      | 1.50                       | 0.0023               |
| 1x1.4                 | 1.40       | 0.055      | 1.50                       | 0.0023               |
| 32x0.20               | 1.35       | 0.053      | 1.00                       | 0.0015               |
| 7x0.43                | 1.29       | 0.050      | 1.00                       | 0.0015               |
| 1x1.15                | 1.15       | 0.045      | 1.00                       | 0.0015               |
| 42x0.15               | 1.20       | 0.047      | 0.75                       | 0.0011               |
| 28x0.20               | 1.15       | 0.045      | 0.75                       | 0.0011               |
| 1x1.0                 | 1.00       | 0.039      | 0.75                       | 0.0011               |
| 28x0.15               | 0.95       | 0.037      | 0.50                       | 7.7x10 <sup>-4</sup> |
| 16x0.20               | 0.90       | 0.035      | 0.50                       | 7.7x10 <sup>-4</sup> |
| 1x0.80                | 0.80       | 0.031      | 0.50                       | 7.7x10 <sup>-4</sup> |
| 7x0.25                | 0.75       | 0.029      | 0.34                       | 5.2x10 <sup>-4</sup> |
| 1x0.60                | 0.60       | 0.023      | 0.28                       | 4.3x10 <sup>-4</sup> |
| 14x0.15               | 0.75       | 0.029      | 0.25                       | 3.8x10 <sup>-4</sup> |
| 7x0.20                | 0.65       | 0.023      | 0.22                       | 3.4x10 <sup>-4</sup> |
| 18x0.10               | 0.50       | 0.019      | 0.14                       | 2.1x10 <sup>-4</sup> |
| 14x0.10               | 0.40       | 0.015      | 0.11                       | 1.7x10 <sup>-4</sup> |
| 21x0.07               | 0.40       | 0.015      | 0.09                       | 1.3x10 <sup>-4</sup> |
| 14x0.10               | 0.40       | 0.015      | 0.09                       | 1.3x10 <sup>-4</sup> |

Note: 1) not included in the standard

## Product safety notice

**PLEASE READ AND FOLLOW ALL INSTRUCTIONS CAREFULLY AND CONSULT ALL RELEVANT NATIONAL AND INTERNATIONAL SAFETY REGULATIONS FOR YOUR APPLICATION. IMPROPER HANDLING, CABLE ASSEMBLY, OR WRONG USE OF CONNECTORS CAN RESULT IN HAZARDOUS SITUATIONS.**

### 1. SHOCK AND FIRE HAZARD

Incorrect wiring, the use of damaged components, presence of foreign objects (such as metal debris), and / or residue (such as cleaning fluids), can result in short circuits, overheating, and / or risk of electric shock.

Mated components should never be disconnected while live as this may result in an exposed electric arc and local overheating, resulting in possible damage to components.

### 2. HANDLING

Connectors and their components should be visually inspected for damage prior to installation and assembly. Suspect components should be rejected or returned to the factory for verification.

Connector assembly and installation should only be carried out by properly trained personnel. Proper tools must be used during installation and / or assembly in order to obtain safe and reliable performance.

### 3. USE

Connectors with exposed contacts should never be live (or on the current supply side of a circuit). Under general conditions voltages above 30 VAC and 42 VDC are considered hazardous and proper measures should be taken to eliminate all risk of transmission of such voltages to any exposed metal part of the connector.

### 4. TEST AND OPERATING VOLTAGES

The maximum admissible operating voltage depends upon the national or international standards in force for the application in question. Air and creepage distances impact the operating voltage; reference values are indicated in the catalog however these may be influenced by PC board design and / or wiring harnesses.

The test voltage indicated in the catalog is 75% of the mean breakdown voltage; the test is applied at 500 V/s and the test duration is 1 minute.

### 5. CE MARKING

CE marking  means that the appliance or equipment bearing it complies with the protection requirements of one or several European safety directives.

CE marking  applies to complete products or equipment, **but not to electromechanical components, such as connectors.**

### 6. PRODUCT IMPROVEMENTS

The LEMO Group reserves the right to modify and improve to our products or specifications without providing prior notification.

**Notes**

# LEMO complete product range

|                    | B | S | K | E | F | 00 | 01 | 0A | 3T | 4A | 4M | 3K.93C | 1D | Y | 05 | 5G | 2G | 2C | L | H | M | R | N | 03 | V | W | T7 | P | D | K/S | 01 | DIN |  |
|--------------------|---|---|---|---|---|----|----|----|----|----|----|--------|----|---|----|----|----|----|---|---|---|---|---|----|---|---|----|---|---|-----|----|-----|--|
| Unipole            |   |   |   |   |   |    |    |    |    |    |    |        |    |   |    |    |    |    |   |   |   |   |   |    |   |   |    |   |   |     |    |     |  |
| Multipole          |   |   |   |   |   |    |    |    |    |    |    |        |    |   |    |    |    |    |   |   |   |   |   |    |   |   |    |   |   |     |    |     |  |
| Coaxial 50 Ω       |   |   |   |   |   |    |    |    |    |    |    |        |    |   |    |    |    |    |   |   |   |   |   |    |   |   |    |   |   |     |    |     |  |
| Coaxial 75 Ω       |   |   |   |   |   |    |    |    |    |    |    |        |    |   |    |    |    |    |   |   |   |   |   |    |   |   |    |   |   |     |    |     |  |
| Multi Coaxial      |   |   |   |   |   |    |    |    |    |    |    |        |    |   |    |    |    |    |   |   |   |   |   |    |   |   |    |   |   |     |    |     |  |
| Mixed Coax + LV    |   |   |   |   |   |    |    |    |    |    |    |        |    |   |    |    |    |    |   |   |   |   |   |    |   |   |    |   |   |     |    |     |  |
| Triaxial 50 Ω      |   |   |   |   |   |    |    |    |    |    |    |        |    |   |    |    |    |    |   |   |   |   |   |    |   |   |    |   |   |     |    |     |  |
| Triaxial 75 Ω      |   |   |   |   |   |    |    |    |    |    |    |        |    |   |    |    |    |    |   |   |   |   |   |    |   |   |    |   |   |     |    |     |  |
| Mixed Triax + LV   |   |   |   |   |   |    |    |    |    |    |    |        |    |   |    |    |    |    |   |   |   |   |   |    |   |   |    |   |   |     |    |     |  |
| Quadrax            |   |   |   |   |   |    |    |    |    |    |    |        |    |   |    |    |    |    |   |   |   |   |   |    |   |   |    |   |   |     |    |     |  |
| High Voltage       |   |   |   |   |   |    |    |    |    |    |    |        |    |   |    |    |    |    |   |   |   |   |   |    |   |   |    |   |   |     |    |     |  |
| Multi High Voltage |   |   |   |   |   |    |    |    |    |    |    |        |    |   |    |    |    |    |   |   |   |   |   |    |   |   |    |   |   |     |    |     |  |
| Mixed HV + LV      |   |   |   |   |   |    |    |    |    |    |    |        |    |   |    |    |    |    |   |   |   |   |   |    |   |   |    |   |   |     |    |     |  |
| Fibre Optic        |   |   |   |   |   |    |    |    |    |    |    |        |    |   |    |    |    |    |   |   |   |   |   |    |   |   |    |   |   |     |    |     |  |
| Multi Fibre Optic  |   |   |   |   |   |    |    |    |    |    |    |        |    |   |    |    |    |    |   |   |   |   |   |    |   |   |    |   |   |     |    |     |  |
| Mixed FO + LV      |   |   |   |   |   |    |    |    |    |    |    |        |    |   |    |    |    |    |   |   |   |   |   |    |   |   |    |   |   |     |    |     |  |
| Thermocouple       |   |   |   |   |   |    |    |    |    |    |    |        |    |   |    |    |    |    |   |   |   |   |   |    |   |   |    |   |   |     |    |     |  |
| Fluidic            |   |   |   |   |   |    |    |    |    |    |    |        |    |   |    |    |    |    |   |   |   |   |   |    |   |   |    |   |   |     |    |     |  |
| Multi Fluidic      |   |   |   |   |   |    |    |    |    |    |    |        |    |   |    |    |    |    |   |   |   |   |   |    |   |   |    |   |   |     |    |     |  |
| Mixed Fluidic + LV |   |   |   |   |   |    |    |    |    |    |    |        |    |   |    |    |    |    |   |   |   |   |   |    |   |   |    |   |   |     |    |     |  |

Most frequently used in darker colour

| B Series Keyed  | S Series             | K Series Keyed  | E Series        | F Series Keyed      | 00 Series      | 01 Series        |
|-----------------|----------------------|-----------------|-----------------|---------------------|----------------|------------------|
|                 |                      |                 |                 |                     |                |                  |
| 0A Series       | 3T Series            | 4A Series       | 4M Series Keyed | 3K.93C Series Keyed | 1D Series      | Y Series         |
|                 |                      |                 |                 |                     |                |                  |
| 05 Series       | 5G Series Keyed      | 2G Series Keyed | 2C Series       | L Series Keyed      | H Series       | M Series Keyed   |
|                 |                      |                 |                 |                     |                |                  |
| R Series Keyed  | N Series Keyed       | 03 Series Keyed | V Series        | W Series Keyed      | Cable assembly | K/S Series Keyed |
|                 |                      |                 |                 |                     |                |                  |
| REDEL T7 Series | REDEL P Series Keyed | REDEL D Series  | 01 Series Keyed | VAA Series          | SAA Series     | TAA Series       |
|                 |                      |                 |                 |                     |                |                  |



## LEMO HEADQUARTERS

### SWITZERLAND

#### LEMO SA

Chemin des Champs-Courbes 28 - P.O. Box 194 - CH-1024 Ecublens  
Tel. (+41 21) 695 16 00 - Fax (+41 21) 695 16 02 - e-mail: info@lemo.com

## LEMO SUBSIDIARIES

### AUSTRIA

#### LEMO Elektronik GesmbH

Lemböckgasse 49/E6-3  
1230 Wien  
Tel: (+43 1) 914 23 20 0  
Fax: (+43 1) 914 23 20 11  
sales@lemo.at

### CANADA

#### LEMO Canada Inc

44 East Beaver Creek Road, unit 20  
Richmond Hill, Ontario L4B 1G8  
Tel: (+1 905) 889 56 78  
Fax: (+1 905) 889 49 70  
info-canada@lemo.com

### CHINA / HONG KONG

#### LEMO Electronics (Shanghai) Co., Ltd

5th Floor, Block 6, City of ELITE,  
1000 Jinhai Road, Pudong  
Shanghai, China 201206  
Tel: (+86 21) 5899 7721  
Fax: (+86 21) 5899 7727  
cn.sales@lemo.com

### DENMARK

#### LEMO Denmark A/S

Gammel Mosevej 46  
2820 Gentofte  
Tel: (+45) 45 20 44 00  
Fax: (+45) 45 20 44 01  
info-dk@lemo.com

### FRANCE

#### LEMO France Sàrl

24/28 Avenue Graham Bell  
Bâtiment Balthus 4  
Bussy Saint Georges  
77607 Marne la Vallée Cedex 3  
Tel: (+33 1) 60 94 60 94  
Fax: (+33 1) 60 94 60 90  
info-fr@lemo.com

### GERMANY

#### LEMO Elektronik GmbH

Hanns-Schwindt-Str. 6  
81829 München  
Tel: (+49 89) 42 77 03  
Fax: (+49 89) 420 21 92  
info@lemo.de

### HUNGARY

#### REDEL Elektronika Kft

Nagysándor József u. 6-12  
1201 Budapest  
Tel: (+36 1) 421 47 10  
Fax: (+36 1) 421 47 57  
info-hu@lemo.com

### ITALY

#### LEMO Italia srl

Viale Lunigiana 25  
20125 Milano  
Tel: (+39 02) 66 71 10 46  
Fax: (+39 02) 66 71 10 66  
sales.it@lemo.com

### JAPAN

#### LEMO Japan Ltd

2-7-22, Mita,  
Minato-ku, Tokyo, 108-0073  
Tel: (+81 3) 54 46 55 10  
Fax: (+81 3) 54 46 55 11  
lemoinfo@lemo.co.jp

### NETHERLANDS / BELGIUM

#### LEMO Connectors Benelux

De Trompet 1060  
1967 DA Heemskerk  
Tel: (+31) 251 25 78 20  
Fax: (+31) 251 25 78 21  
info@lemo.nl

### NORWAY / ICELAND

#### LEMO Norway A/S

Stanseveien 6B  
0975 Oslo  
Tel: (+47) 22 91 70 40  
Fax: (+47) 22 91 70 41  
info-no@lemo.com

### SINGAPORE

#### LEMO Asia Pte Ltd

4 Leng Kee Road,  
#06-09 SiS Building  
Singapore 159088  
Tel: (+65) 6476 0672  
Fax: (+65) 6474 0672  
sg.sales@lemo.com

### SPAIN / PORTUGAL

#### IBERLEMO SAU

Brasil, 45, 08402 Granollers  
Barcelona  
Tel: (+34 93) 860 44 20  
Fax: (+34 93) 879 10 77  
info-es@lemo.com

### SWEDEN / FINLAND

#### LEMO Nordic AB

Mariehällsvägen 39A  
168 65 Bromma  
Tel: (+46 8) 635 60 60  
Fax: (+46 8) 635 60 61  
info-se@lemo.com

### SWITZERLAND

#### LEMO Verkauf AG

Grundstrasse 22 B  
6343 Rotkreuz  
Tel: (+41 41) 790 49 40  
Fax: (+41 41) 790 49 43  
ch.sales@lemo.com

### UNITED KINGDOM

#### LEMO UK Ltd

12-20 North Street  
Worthing, West Sussex, BN11 1DU  
Tel: (+44 1903) 23 45 43  
Fax: (+44 1903) 20 62 31  
lemouk@lemo.com

### USA

#### LEMO USA Inc

P.O. Box 2408  
Rohnert Park, CA 94927-2408  
Tel: (+1 707) 578 88 11  
(+1 800) 444 53 66  
Fax: (+1 707) 578 08 69  
info@lemousa.com

## LEMO DISTRIBUTORS

AUSTRALIA, BRAZIL, CHILE, CZECH REPUBLIC, GREECE, INDIA, ISRAEL,  
NEW ZEALAND, PAKISTAN, POLAND, RUSSIA, SOUTH AFRICA,  
SOUTH KOREA, TAIWAN, TURKEY, UKRAINE

[www.lemo.com](http://www.lemo.com)





Компания «ЭлектроПласт» предлагает заключение долгосрочных отношений при поставках импортных электронных компонентов на взаимовыгодных условиях!

Наши преимущества:

- Оперативные поставки широкого спектра электронных компонентов отечественного и импортного производства напрямую от производителей и с крупнейших мировых складов;
- Поставка более 17-ти миллионов наименований электронных компонентов;
- Поставка сложных, дефицитных, либо снятых с производства позиций;
- Оперативные сроки поставки под заказ (от 5 рабочих дней);
- Экспресс доставка в любую точку России;
- Техническая поддержка проекта, помощь в подборе аналогов, поставка прототипов;
- Система менеджмента качества сертифицирована по Международному стандарту ISO 9001;
- Лицензия ФСБ на осуществление работ с использованием сведений, составляющих государственную тайну;
- Поставка специализированных компонентов (Xilinx, Altera, Analog Devices, Intersil, Interpoint, Microsemi, Aeroflex, Peregrine, Syfer, Eurofarad, Texas Instrument, Miteq, Cobham, E2V, MA-COM, Hittite, Mini-Circuits, General Dynamics и др.);

Помимо этого, одним из направлений компании «ЭлектроПласт» является направление «Источники питания». Мы предлагаем Вам помощь Конструкторского отдела:

- Подбор оптимального решения, техническое обоснование при выборе компонента;
- Подбор аналогов;
- Консультации по применению компонента;
- Поставка образцов и прототипов;
- Техническая поддержка проекта;
- Защита от снятия компонента с производства.



#### Как с нами связаться

**Телефон:** 8 (812) 309 58 32 (многоканальный)

**Факс:** 8 (812) 320-02-42

**Электронная почта:** [org@eplast1.ru](mailto:org@eplast1.ru)

**Адрес:** 198099, г. Санкт-Петербург, ул. Калинина, дом 2, корпус 4, литера А.