

# MAX9065

## Ultra-Small, nanoPower, Window Comparator in 4 UCSP and 5 SOT23

### General Description

The MAX9065 is an ultra-small, low-power, window comparator ideal for a wide variety of portable electronics applications such as cell phones, portable media players, and notebooks that have extremely tight board space and power constraints. It comes in both a 4-bump UCSP™ package with a 1mm x 1mm footprint (as small as two 0402 resistors) and a 5-pin SOT23 package.

The MAX9065 features a common-mode input range of -0.3V to +5.5V independent of supply voltage. The input current goes to zero when the MAX9065 is powered down ( $V_{CC} = 0$ ). Additionally, the MAX9065 features high RF immunity.

The MAX9065 has a push-pull output and consumes only 1 $\mu$ A (max) supply current. The MAX9065 operates down to 1.0V over the extended -40°C to +85°C temperature range.

### Applications

- Cell Phones
- Portable Media Players
- Electronic Toys
- Notebook Computers
- Portable Medical Devices

### Pin Configurations

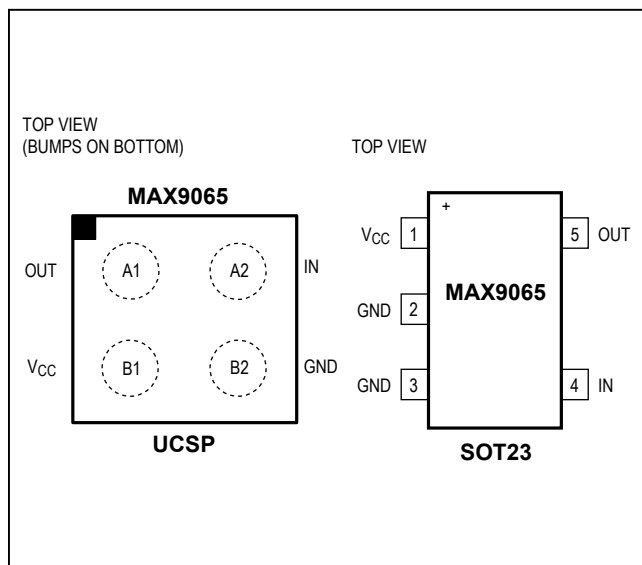

UCSP is a trademark of Maxim Integrated Products, Inc.

### Features

- Tiny 1mm x 1mm 4-Bump UCSP
  - Footprint = Two 0402 Resistors
  - Also Available in 5-Pin SOT23 Package
- Ultra-Low Power Operating Current
  - 1 $\mu$ A (max)
- -0.3V to +5.5V Input Voltage Range
- 1.0V to 5.5V  $V_{CC}$  Range
- 3.0V and 4.2V Trigger Points
- -40°C to +85°C Extended Temperature Range

### Ordering Information

PART	PIN-PACKAGE	TOP MARK
MAX9065EBS+G45	4 UCSP	AGC
MAX9065EUK+	5 SOT23	AFFL
MAX9065AEWS+TCNB	4 WLP	AGO

**Note:** All devices are specified over the extended -40°C to +85°C operating temperature range.

+Denotes a lead-free/RoHS-compliant package.

G45 = Protective die coating.

### Typical Operating Circuit

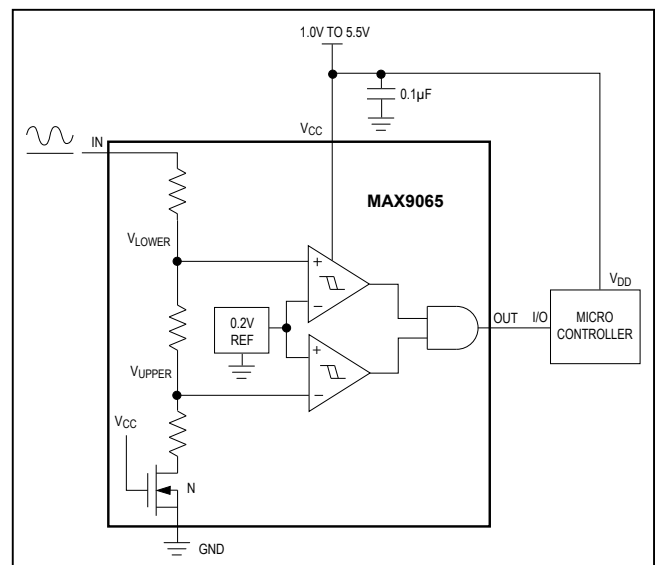

**Absolute Maximum Ratings**

V<sub>CC</sub>, IN to GND.....-0.3V to +6V  
 OUT to GND.....-0.3V to (V<sub>CC</sub> + 0.3V)  
 Output Short-Circuit Current Duration..... 10s  
 Input Current into Any Terminal..... ±20mA  
 Continuous Power Dissipation  
 4-Bump UCSP (derate 3.0mW/°C above +70°C).....238mW  
 5-Pin SOT23 (derate 3.9mW/°C above +70°C) .....312mW  
 4-Bump WLP (derate 3mW/°C above +70°C).....915mW

Operating Temperature Range..... -40°C to +85°C  
 Junction Temperature..... +150°C  
 Storage Temperature Range..... -65°C to +150°C  
 Lead Temperature (SOT23 only, soldering 10s).....+300°C  
 Soldering Temperature (reflow).....+260°C

*Stresses beyond those listed under "Absolute Maximum Ratings" may cause permanent damage to the device. These are stress ratings only, and functional operation of the device at these or any other conditions beyond those indicated in the operational sections of the specifications is not implied. Exposure to absolute maximum rating conditions for extended periods may affect device reliability.*

**Electrical Characteristics**

(V<sub>CC</sub> = 3.3V, T<sub>A</sub> = -40°C to +85°C. Typical values are at T<sub>A</sub> = +25°C, unless otherwise noted.) (Note 1)

PARAMETER	SYMBOL	CONDITIONS	MIN	TYP	MAX	UNITS	
<b>DC CHARACTERISTICS</b>							
Upper Threshold Voltage	UTV	MAX9065EBS+ 4 UCSP	T <sub>A</sub> = +25°C	4.158	4.20	4.242	V
			-40°C < T <sub>A</sub> < +85°C	4.10		4.30	
		MAX9065EUK+ 5 SOT23	T <sub>A</sub> = +25°C	4.04	4.20	4.36	
			-40°C < T <sub>A</sub> < +85°C	3.98		4.42	
		MAX9065AEBS+ 4 UCSP	T <sub>A</sub> = +25°C	1.152	1.20	1.248	
			-40°C < T <sub>A</sub> < +85°C	1.132		1.268	
Lower Threshold Voltage	LTV	MAX9065EBS+ 4 UCSP	T <sub>A</sub> = +25°C	2.94	3.00	3.06	V
			-40°C < T <sub>A</sub> < +85°C	2.92		3.08	
		MAX9065EUK+ 5 SOT23	T <sub>A</sub> = +25°C	2.88	3.00	3.12	
			-40°C < T <sub>A</sub> < +85°C	2.83		3.17	
		MAX9065AEBS+ 4 UCSP	T <sub>A</sub> = +25°C	0.576	0.60	0.624	
			-40°C < T <sub>A</sub> < +85°C	0.566		0.634	
Input Voltage Range	V <sub>IN</sub>		-0.3		+5.5	V	
Hysteresis	V <sub>HYS</sub>	(Note 2)		±1.0		%	
Resistor String Input Resistance	R <sub>IN</sub>		5.8	11	17.7	MΩ	
Input Shutdown Current	I <sub>IN_SHDN</sub>	V <sub>CC</sub> = 0V, V <sub>IN</sub> = 5.5V		1	15	nA	
Output Voltage Low	V <sub>OL</sub>	I <sub>SINK</sub> = 100µA, V <sub>CC</sub> = 1V, T <sub>A</sub> = +25°C			0.2	V	
		I <sub>SINK</sub> = 1.2mA, V <sub>CC</sub> = 3.3V			0.3		
		I <sub>SINK</sub> = 1.2mA, V <sub>CC</sub> = 5.5V			0.5		
Output Voltage High	V <sub>OH</sub>	I <sub>SOURCE</sub> = 25µA, V <sub>CC</sub> = 1V, T <sub>A</sub> = +25°C			V <sub>CC</sub> - 0.2	V	
		I <sub>SOURCE</sub> = 0.3mA, V <sub>CC</sub> = 3.3V			V <sub>CC</sub> - 0.3		
		I <sub>SOURCE</sub> = 0.75mA, V <sub>CC</sub> = 5.5V			V <sub>CC</sub> - 0.5		
<b>AC CHARACTERISTICS</b>							
Propagation Delay	t <sub>PD</sub>	Overdrive = ±100mV (Notes 3, 4)		25		µs	
Fall Time	t <sub>F</sub>	C <sub>L</sub> = 10pF		14		ns	
Rise Time	t <sub>R</sub>	C <sub>L</sub> = 10pF		30		ns	

**Electrical Characteristics (continued)**

( $V_{CC} = 3.3V$ ,  $T_A = -40^{\circ}C$  to  $+85^{\circ}C$ . Typical values are at  $T_A = +25^{\circ}C$ , unless otherwise noted.) (Note 1)

PARAMETER	SYMBOL	CONDITIONS	MIN	TYP	MAX	UNITS
<b>POWER SUPPLY</b>						
Supply Voltage	$V_{CC}$	Guaranteed by $V_{OS}$ tests	1		5.5	V
Supply Current	$I_{CC}$	$V_{CC} = 5.5V$		0.7	1.35	$\mu A$
		$V_{CC} = 1.0V$ , $T_A = +25^{\circ}C$		0.6	1.0	
Power-Supply Rejection Ratio	PSRR	$V_{CC} = 0.9V$ to $5.5V$ , $T_A = +25^{\circ}C$	40	53		dB
Power-Up Time	$t_{ON}$			3		ms

**Note 1:** All devices are 100% production tested at  $T_A = +25^{\circ}C$ . Temperature limits are guaranteed by design.

**Note 2:** Hysteresis is the input voltage difference between the two switching points.

**Note 3:** Overdrive is defined as the voltage above or below the average of the switching points.

**Note 4:** Guaranteed by ATE and/or bench characterization over temperature.

**Typical Operating Characteristics**

( $V_{CC} = 3.3V$ ,  $T_A = -40^{\circ}C$  to  $+85^{\circ}C$ . Typical values are at  $T_A = +25^{\circ}C$ , unless otherwise noted.)

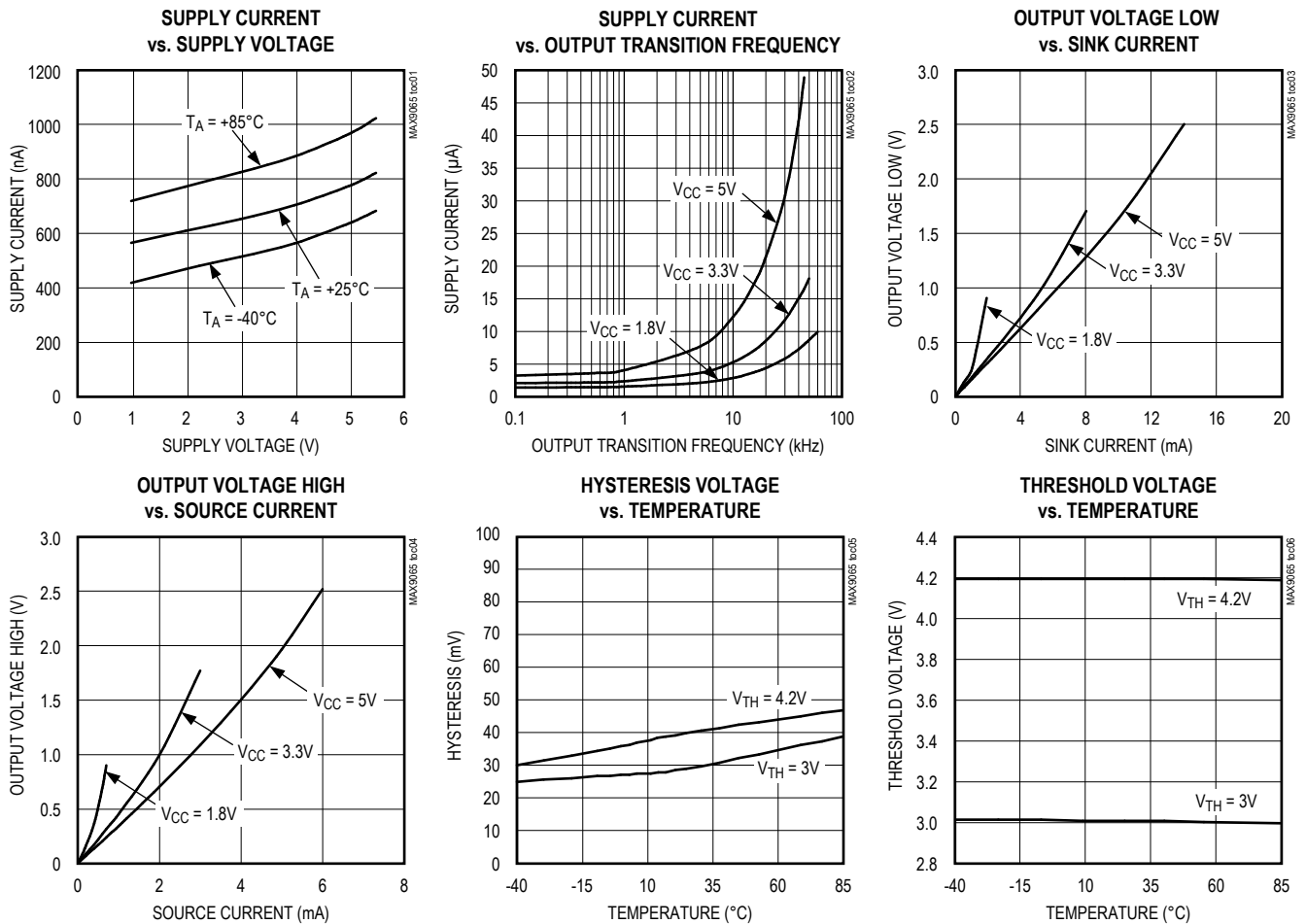

Typical Operating Characteristics (continued)

( $V_{CC} = 3.3V$ ,  $T_A = -40^{\circ}C$  to  $+85^{\circ}C$ . Typical values are at  $T_A = +25^{\circ}C$ , unless otherwise noted.)

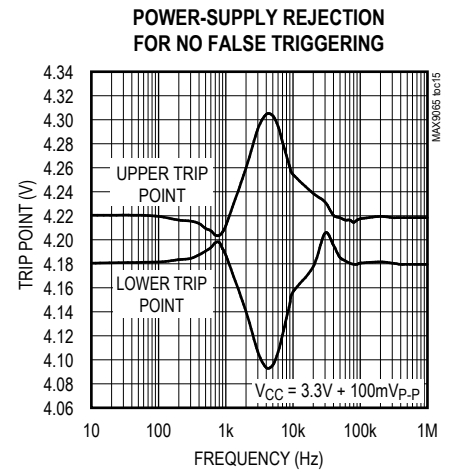
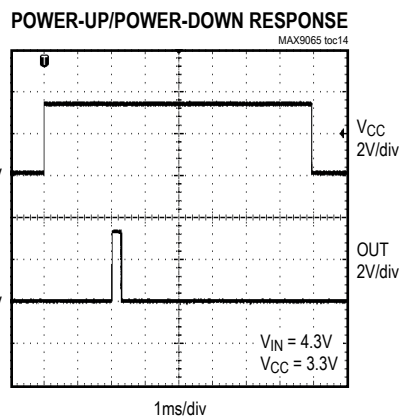
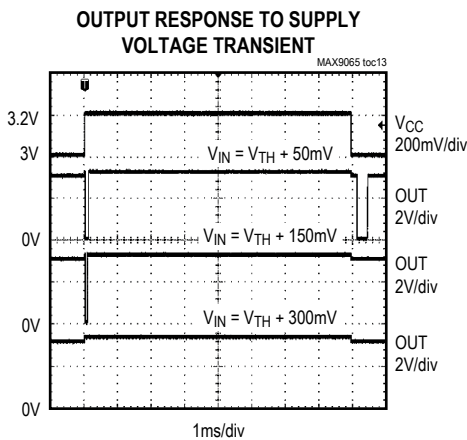
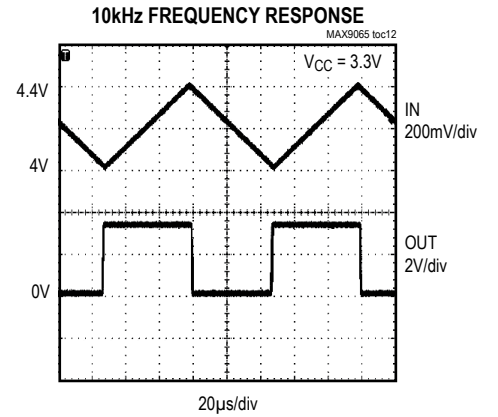
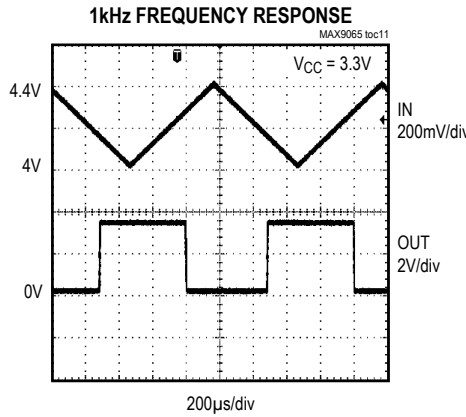
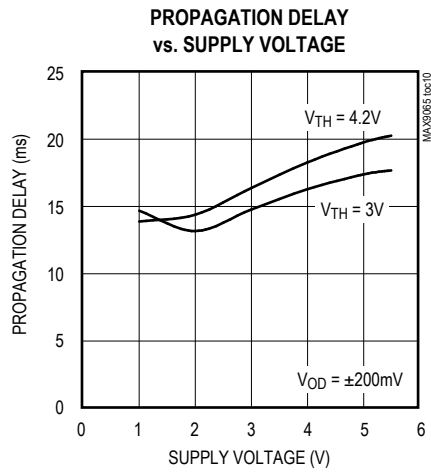
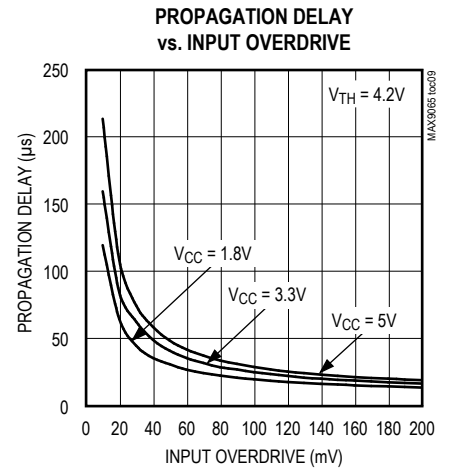
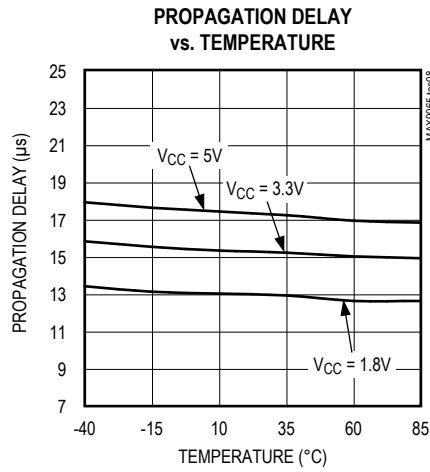
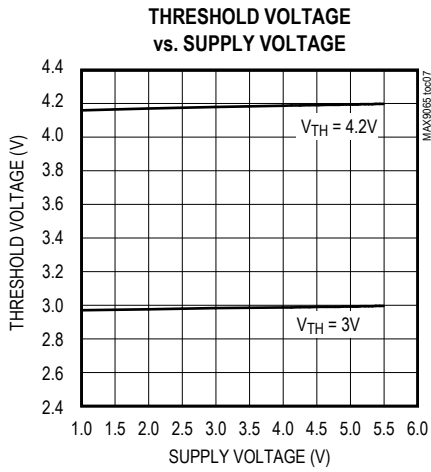

## Pin Description

PIN		NAME	FUNCTION
SOT23	UCSP		
1	B1	V <sub>CC</sub>	External Supply Input. Bypass to ground with a 0.1µF bypass capacitor.
2, 3	B2	GND	Ground
4	A2	IN	Window Comparator Input
5	A1	OUT	Push-Pull Output

## Detailed Description

The MAX9065 is an extremely small window comparator designed for compact, low-current applications, featuring a supply current of less than 1µA (max).

### MAX9065 Operation

At the heart of the MAX9065 are two comparators, a resistor-divider with a disconnect switch, a 200mV reference, digital logic circuitry, and an output stage (see the [Typical Operating Circuit](#)).

The digital logic circuitry and the output stage together behave like an AND gate. The gate's inputs are the outputs of the two comparators. When either comparator's output is low, the output asserts low. When both comparator's outputs are high, the output asserts high.

When power is applied to V<sub>CC</sub>, the n-channel FET at the bottom of the resistor-divider is turned on. The resistor-divider provides two voltages, V<sub>UPPER</sub> and V<sub>LOWER</sub>, for comparison with an internal 0.2V reference voltage. When the input voltage exceeds 4.2V, V<sub>UPPER</sub> is greater than 0.2V, causing the output to assert low. When the input voltage falls below 3.0V, V<sub>LOWER</sub> is less than 0.2V, causing the output also to assert low. With the input voltage between 3.0V and 4.2V, the output asserts high, indicating that the input voltage is within the desired range. [Table 1](#) summarizes the operation of the MAX9065.

When V<sub>CC</sub> goes to 0V, the n-channel FET is turned off, eliminating the resistor-divider as a leakage path for current.

**Table 1. MAX9065 Operation**

INPUT VOLTAGE	OUTPUT
V <sub>IN</sub> > 4.2V	Low
3.0V < V <sub>IN</sub> < 4.2V	High
V <sub>IN</sub> < 3.0V	Low

**Table 2. MAX9065A Operation**

INPUT VOLTAGE	OUTPUT
V <sub>IN</sub> > 1.2V	Low
0.6V < V <sub>IN</sub> < 1.2V	High
V <sub>IN</sub> < 0.6V	Low

### MAX9065A Operation

The resistor-divider provides two voltages, V<sub>UPPER</sub> and V<sub>LOWER</sub>, for comparison with an internal 0.2V reference voltage. When the input voltage exceeds 1.2V, V<sub>UPPER</sub> is greater than 0.2V, causing the output to assert low.

When the input voltage falls below 0.6V, V<sub>LOWER</sub> is less than 0.2V, causing the output also to assert low. With the input voltage between 0.6V and 1.2V, the output asserts high, indicating that the input voltage is within the desired range. [Table 2](#) summarizes the operation of the MAX9065A.

## Applications

The MAX9065 is designed specifically to monitor the voltage on a single lithium battery. Keeping the voltage on a lithium battery within a tight range is important to prevent damage to the battery. Specifically, ensuring that the battery's voltage neither exceeds 4.2V nor falls below 3.0V lengthens the lifetime of the battery and avoids any hazardous battery conditions.

### Hysteresis

There are four trip points for hysteresis. See [Figure 1](#).

### Power-Supply Considerations

Bypass V<sub>CC</sub> with a 0.1µF capacitor to ground.

## Chip Information

PROCESS: BiCMOS

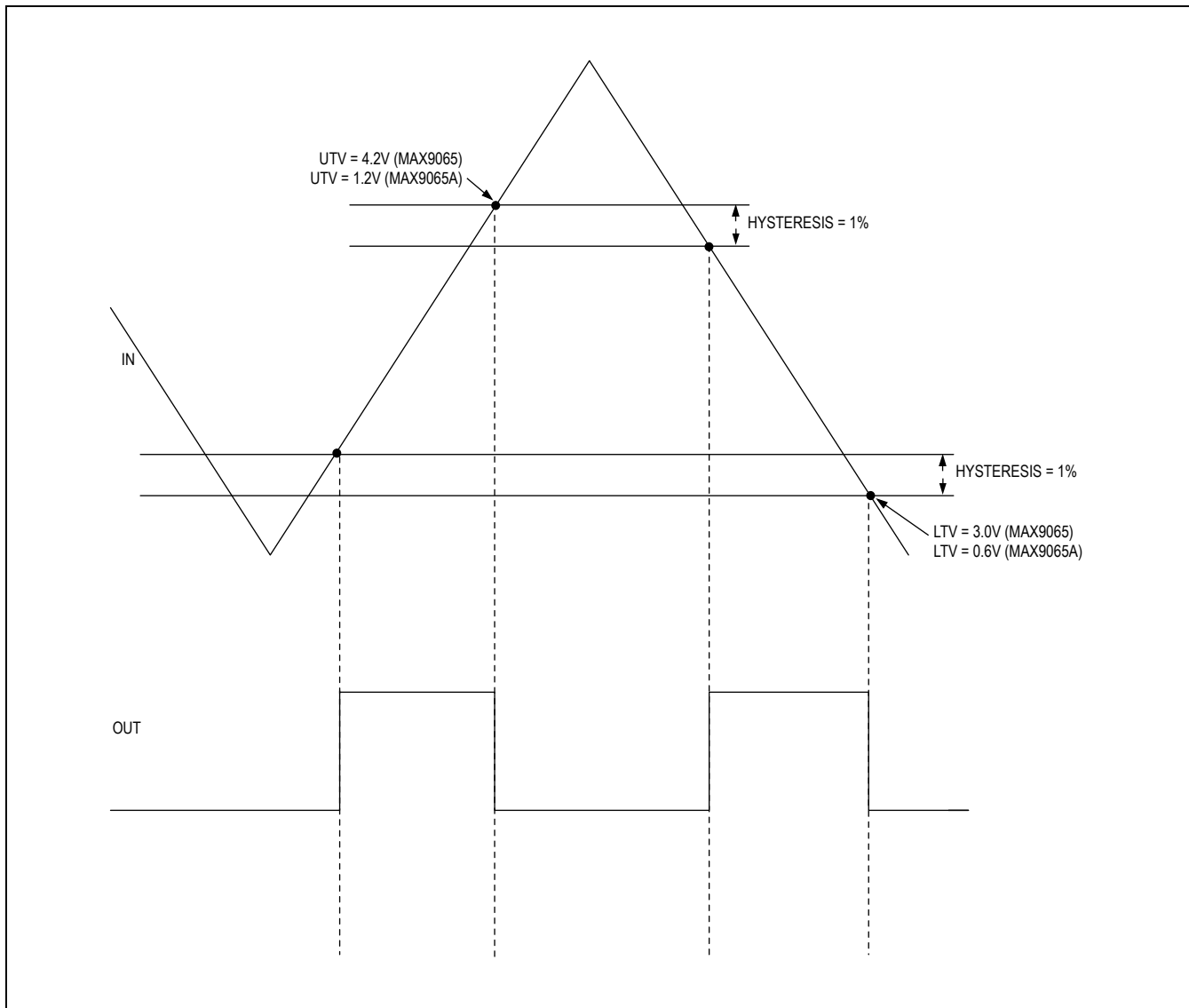

Figure 1. Hysteresis Trip Points

**Package Information**

For the latest package outline information and land patterns (footprints), go to [www.maximintegrated.com/packages](http://www.maximintegrated.com/packages). Note that a “+”, “#”, or “-” in the package code indicates RoHS status only. Package drawings may show a different suffix character, but the drawing pertains to the package regardless of RoHS status.

PACKAGE TYPE	PACKAGE CODE	OUTLINE NO.	LAND PATTERN NO.
5 SOT23	U5+2	<a href="#">21-0057</a>	<a href="#">90-0174</a>
4 UCSP	B4+1	<a href="#">21-0117</a>	Refer to <a href="#">Application Note 1891</a>
4 WLP	W41E1+1	<a href="#">21-0885</a>	<a href="#">90-0366</a>

**COMMON DIMENSIONS**

A	0.62±0.05-0.08
A1	0.29±0.02
A2	0.33 REF.
b	∅0.35±0.03
D1	0.50 BASIC
E1	0.50 BASIC
e	0.50 BASIC
SD	0.25 BASIC
SE	0.25 BASIC

**VARIABLE DIMENSIONS**

PKG. CODE	VARIABLE DIMENSIONS		DEPOPULATED SOLDER BALLS
	D	E	
B4-2	1.05±0.05	1.05±0.05	NONE
B4-3	1.10±0.05	1.10±0.05	NONE

**NOTES:**

- ALL DIMENSIONS ARE IN MILLIMETERS UNLESS OTHERWISE SPECIFIED.
- MATERIAL MUST COMPLY WITH BANNED AND RESTRICTED SUBSTANCES SPEC #10-0131.
- OUTER DIMENSION (D & E) IS DEFINES BY CENTER LINES BETWEEN SCRIBE LINES.
- MARKING SHOWN IS FOR PACKAGE ORIENTATION REFERENCE ONLY. NUMBER OF CHARACTERS AND LINES VARY PER PRODUCT.
- ALL DIMENSIONS APPLY BOTH TO LEAD FREE (+) & LEADED (-) PKG. CODES.
- PACKAGE CODE: B4-2, B4-3

**maxim integrated™**

TITLE:  
PACKAGE OUTLINE, 4 BUMPS UCSP (B),  
2X2 ARRAY

APPROVAL	DOCUMENT CONTROL NO. 21-0117	REV. J	1/1
----------	---------------------------------	-----------	-----

-DRAWING NOT TO SCALE-

Package Information (continued)

For the latest package outline information and land patterns (footprints), go to [www.maximintegrated.com/packages](http://www.maximintegrated.com/packages). Note that a "+", "#", or "-" in the package code indicates RoHS status only. Package drawings may show a different suffix character, but the drawing pertains to the package regardless of RoHS status.

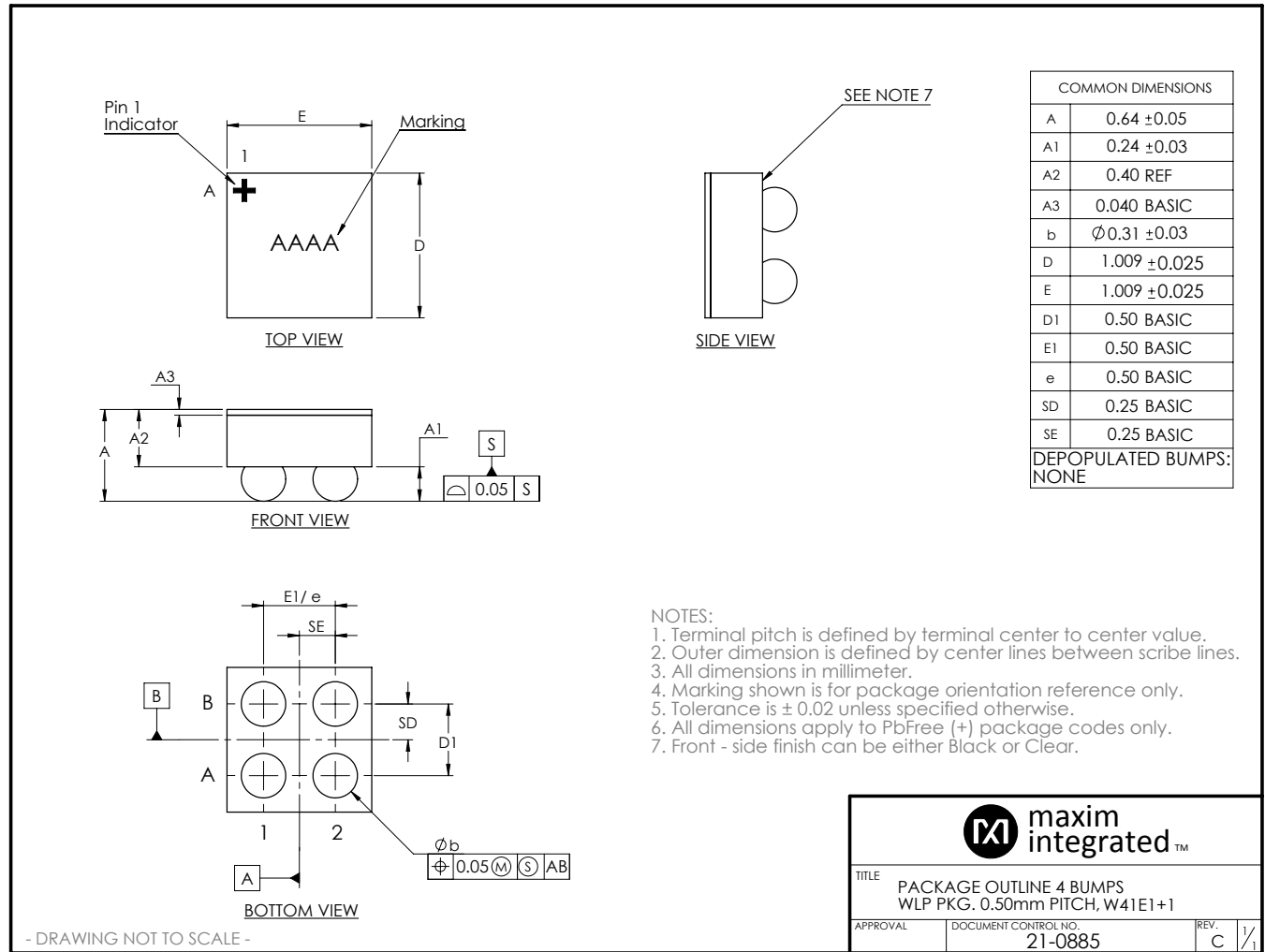



Package Information (continued)

For the latest package outline information and land patterns (footprints), go to [www.maximintegrated.com/packages](http://www.maximintegrated.com/packages). Note that a "+", "#", or "-" in the package code indicates RoHS status only. Package drawings may show a different suffix character, but the drawing pertains to the package regardless of RoHS status.

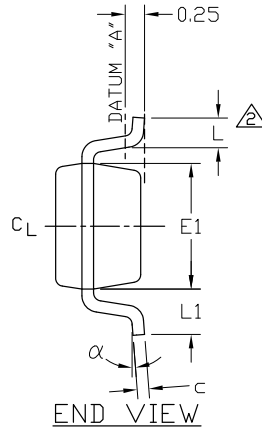
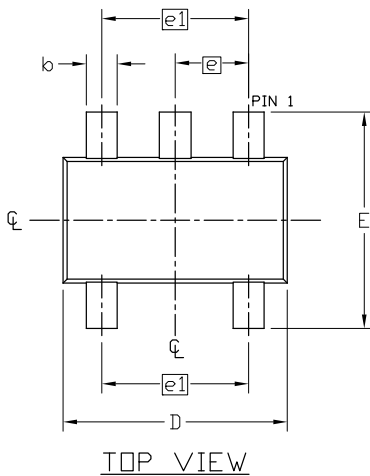

SYMBOL	MIN	NOM	MAX
A	0.90	1.25	1.45
A1	0.00	0.05	0.15
A2	0.90	1.10	1.30
b	0.35	0.40	0.50
c	0.08	0.15	0.20
D	2.80	2.90	3.00
E	2.60	2.80	3.00
E1	1.50	1.625	1.75
L	0.35	0.45	0.60
L1	0.60 REF		
e	0.95 BSC.		
e1	1.90 BSC.		
α	0°	2.5°	8°

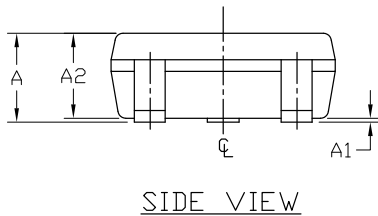

NOTES:

1. ALL DIMENSIONS ARE IN MILLIMETERS UNLESS OTHERWISE SPECIFIED.
2. FOOT LENGTH MEASURED AT INTERCEPT POINT BETWEEN DATUM A & LEAD SURFACE.
3. PACKAGE OUTLINE EXCLUSIVE OF MOLD FLASH & METAL BURR. MOLD FLASH, PROTRUSION OR METAL BURR SHOULD NOT EXCEED 0.25 MM.
4. MEETS JEDEC MO178, VARIATION AA.
5. LEADS TO BE COPLANAR WITHIN 0.10 mm.
6. SOLDER THICKNESS MEASURED AT FLAT SECTION OF LEAD BETWEEN 0.08mm AND 0.15mm FROM LEAD TIP.
7. MATERIAL MUST BE COMPLIANT WITH MAXIM SPECIFICATION 10-0131 FOR SUBSTANCE CONTENT, MUST BE Eu ROHS COMPLIANT WITHOUT EXEMPTION AND PB-FREE.
8. ALL DIMENSIONS APPLY TO BOTH LEADED (-) AND LEAD FREE (+) PACKAGE CODES.
9. PKG CODES: U5-1/U5+1, U5-2/U5+2

-DRAWING NOT TO SCALE-

TITLE: PACKAGE OUTLINE, 5L SOT23			
APPROVAL	DOCUMENT CONTROL NO. 21-0057	REV. I	1/1

## Revision History

REVISION NUMBER	REVISION DATE	DESCRIPTION	PAGES CHANGED
0	7/08	Initial release	—
1	10/08	Removed future part reference from 5 SOT23 package	1
2	1/11	Added G45 designation	1
3	8/15	Corrected error in <i>Typical Operating Circuit</i>	1
4	3/17	Updated title to include “nanoPower” and updated package outline drawings	1–10

For pricing, delivery, and ordering information, please contact Maxim Direct at 1-888-629-4642, or visit Maxim Integrated's website at [www.maximintegrated.com](http://www.maximintegrated.com).

*Maxim Integrated cannot assume responsibility for use of any circuitry other than circuitry entirely embodied in a Maxim Integrated product. No circuit patent licenses are implied. Maxim Integrated reserves the right to change the circuitry and specifications without notice at any time. The parametric values (min and max limits) shown in the Electrical Characteristics table are guaranteed. Other parametric values quoted in this data sheet are provided for guidance.*



Компания «ЭлектроПласт» предлагает заключение долгосрочных отношений при поставках импортных электронных компонентов на взаимовыгодных условиях!

Наши преимущества:

- Оперативные поставки широкого спектра электронных компонентов отечественного и импортного производства напрямую от производителей и с крупнейших мировых складов;
- Поставка более 17-ти миллионов наименований электронных компонентов;
- Поставка сложных, дефицитных, либо снятых с производства позиций;
- Оперативные сроки поставки под заказ (от 5 рабочих дней);
- Экспресс доставка в любую точку России;
- Техническая поддержка проекта, помощь в подборе аналогов, поставка прототипов;
- Система менеджмента качества сертифицирована по Международному стандарту ISO 9001;
- Лицензия ФСБ на осуществление работ с использованием сведений, составляющих государственную тайну;
- Поставка специализированных компонентов (Xilinx, Altera, Analog Devices, Intersil, Interpoint, Microsemi, Aeroflex, Peregrine, Syfer, Eurofarad, Texas Instrument, Miteq, Cobham, E2V, MA-COM, Hittite, Mini-Circuits, General Dynamics и др.);

Помимо этого, одним из направлений компании «ЭлектроПласт» является направление «Источники питания». Мы предлагаем Вам помощь Конструкторского отдела:

- Подбор оптимального решения, техническое обоснование при выборе компонента;
- Подбор аналогов;
- Консультации по применению компонента;
- Поставка образцов и прототипов;
- Техническая поддержка проекта;
- Защита от снятия компонента с производства.



#### Как с нами связаться

**Телефон:** 8 (812) 309 58 32 (многоканальный)

**Факс:** 8 (812) 320-02-42

**Электронная почта:** [org@eplast1.ru](mailto:org@eplast1.ru)

**Адрес:** 198099, г. Санкт-Петербург, ул. Калинина, дом 2, корпус 4, литера А.