

### DESCRIPTION

The MP1921A is a high-frequency, 100V, half bridge, N-channel power MOSFET driver. Its low side and high side driver channels are independently controlled and matched with a time delay of less than 5ns. Under-voltage lockout on both high side and low side supplies force their outputs low in case of insufficient supply. The integrated bootstrap diode reduces external component count.

### FEATURES

- Drives N-Channel MOSFET Half Bridge
- 120V  $V_{BST}$  Voltage Range
- On-Chip Bootstrap Diode
- Typical 16ns Propagation Delay Time
- Less Than 5ns Gate Drive Matching
- Drives 1nF Load with 12ns/9ns Rise/Fall Times with 12V VDD
- TTL Compatible Input
- Less Than 150 $\mu$ A Quiescent Current
- UVLO for Both High Side and Low Side
- In SOIC8E, SOIC-8, 3 $\times$ 3mm QFN8, 3 $\times$ 3mm QFN9 and 4 $\times$ 4mm QFN10 Packages

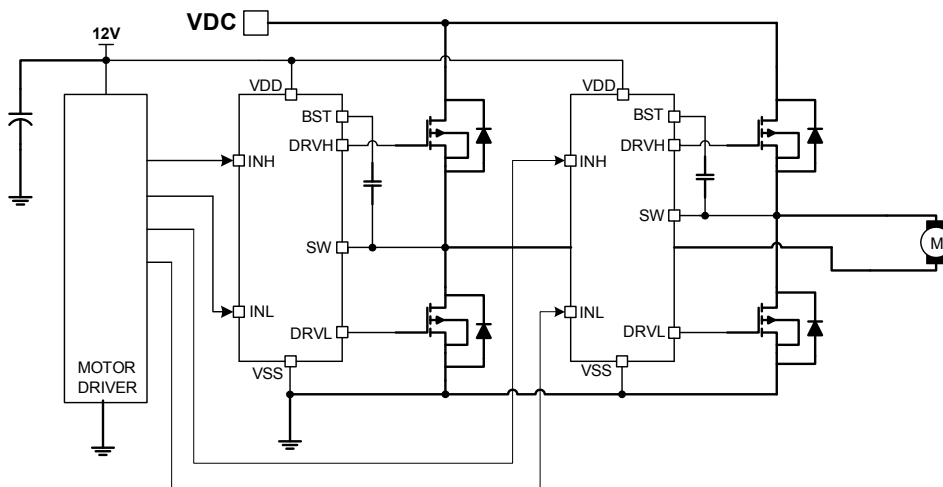
### APPLICATIONS

- Telecom Half Bridge Power Supplies
- Avionics DC-DC Converters
- Two-Switch Forward Converters
- Active Clamp Forward Converters
- DC Motor Drivers

All MPS parts are lead-free and adhere to the RoHS directive. For MPS green status, please visit MPS website under Quality Assurance.

"MPS" and "The Future of Analog IC Technology" are Registered Trademarks of Monolithic Power Systems, Inc.

### TYPICAL APPLICATION

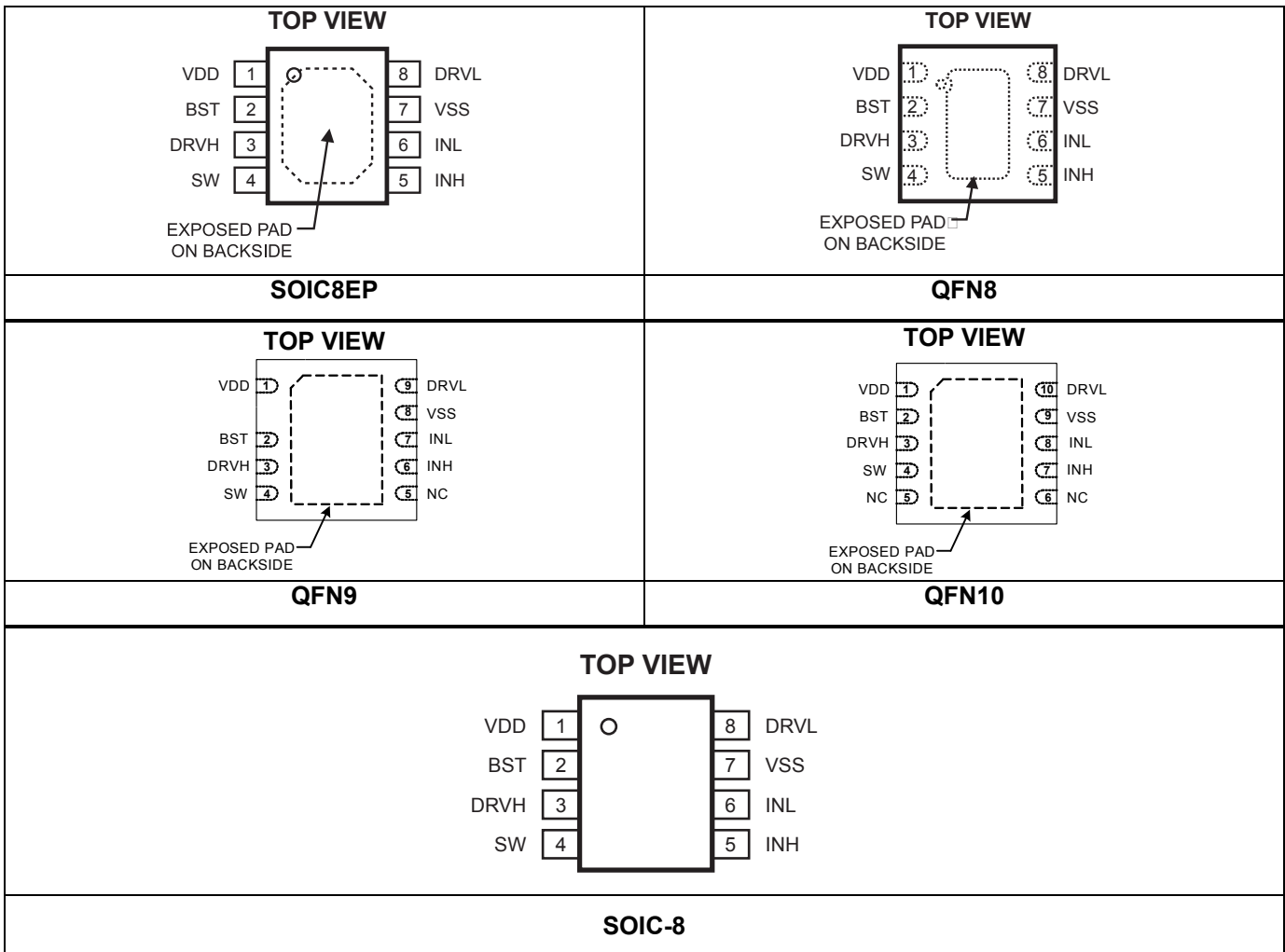


### ORDERING INFORMATION

Part Number	Package	Top Marking
MP1921HN-A*	SOIC8E	MP1921-A
MP1921HQ-A	QFN8 (3x3mm)	AHA
MP1921HQE-A	QFN9 (3x3mm)	AHL
MP1921HR-A	QFN10 (4x4mm)	MP1921 A
MP1921HS-A	SOIC-8	MP1921-A

\* For Tape & Reel, add suffix -Z (e.g. MP1921HN-A-Z);  
 For RoHS compliant packaging, add suffix -LF (e.g. MP1921HN-A-LF-Z)

### PACKAGE REFERENCE



**ABSOLUTE MAXIMUM RATINGS <sup>(1)</sup>**

Supply Voltage ( $V_{DD}$ ).....	-0.3V to +20V
SW Voltage ( $V_{SW}$ ) .....	-5.0V to +105V
BST Voltage ( $V_{BST}$ ) .....	-0.3V to +120V
BST to SW .....	-0.3V to +18V
DRVH to SW .....	-0.3V to (BST-SW) + 0.3V
DRVL to VSS .....	-0.3V to ( $V_{DD}$ + 0.3V)
All Other Pins .....	-0.3V to ( $V_{DD}$ + 0.3V)
Continuous Power Dissipation ( $T_A = 25^\circ\text{C}$ ) <sup>(2)</sup>	
SOIC8E .....	2.6W
QFN8 (3x3mm) .....	2.5W
QFN9 (3x3mm) .....	2.5W
QFN10 (4x4mm) .....	2.66W
SOIC-8 .....	1.3W
Junction Temperature .....	150°C
Lead Temperature .....	260°C
Storage Temperature.....	-65°C to +150°C

**Recommended Operating Conditions <sup>(3)</sup>**

Supply Voltage ( $V_{DD}$ ) .....	9.0V to 18V
SW Voltage ( $V_{SW}$ ) .....	-1.0V to +100V
SW slew rate .....	<50V/nsec
Operating Junction Temp. ( $T_J$ )..	-40°C to +125°C

<b>Thermal Resistance <sup>(4)</sup></b>	<b><math>\theta_{JA}</math></b>	<b><math>\theta_{JC}</math></b>
SOIC8E .....	48 .....	10... °C/W
QFN8 (3x3mm).....	50 .....	12... °C/W
QFN9 (3x3mm).....	50 .....	12... °C/W
QFN10 (4x4mm).....	47 .....	7.... °C/W
SOIC-8.....	96 .....	45... °C/W

**Notes:**

- 1) Exceeding these ratings may damage the device.
- 2) The maximum allowable power dissipation is a function of the maximum junction temperature  $T_J(\text{MAX})$ , the junction-to-ambient thermal resistance  $\theta_{JA}$ , and the ambient temperature  $T_A$ . The maximum allowable continuous power dissipation at any ambient temperature is calculated by  $P_D(\text{MAX}) = (T_J(\text{MAX}) - T_A) / \theta_{JA}$ . Exceeding the maximum allowable power dissipation will cause excessive die temperature, and the regulator will go into thermal shutdown. Internal thermal shutdown circuitry protects the device from permanent damage.
- 3) The device is not guaranteed to function outside of its operating conditions.
- 4) Measured on JESD51-7, 4-layer PCB.

**ELECTRICAL CHARACTERISTICS**
 $V_{DD} = V_{BST} - V_{SW} = 12V$ ,  $V_{SS} = V_{SW} = 0V$ , No load at DRVH and DRVL,  $T_A = 25^\circ C$ , unless otherwise noted.

Parameter	Symbol	Condition	Min	Typ	Max	Units
<b>Supply Currents</b>						
VDD quiescent current	$I_{DDQ}$	INL=INH=0		100	150	$\mu A$
VDD operating current	$I_{DDO}$	$f_{sw} = 500kHz$		2.8	3.5	mA
Floating driver quiescent current	$I_{BSTQ}$	INL=INH=0		60	90	$\mu A$
Floating driver operating current	$I_{BSTO}$	$f_{sw} = 500kHz$		2.1	3	mA
Leakage Current	$I_{LK}$	BST=SW=100V		0.05	1	$\mu A$
<b>Inputs</b>						
INL/INH High				2	2.4	V
INL/INH Low			1	1.4		V
INL/INH internal pull-down resistance	$R_{IN}$			185		k $\Omega$
<b>Under Voltage Protection</b>						
VDD rising threshold	$V_{DDR}$		7.7	8.1	8.5	V
VDD hysteresis	$V_{DDH}$			0.5		V
(BST-SW) rising threshold	$V_{BSTR}$		6.7	7.1	7.5	V
(BST-SW) hysteresis	$V_{BSTH}$			0.55		V
<b>Bootstrap Diode</b>						
Bootstrap diode VF @ 100uA	$V_{F1}$			0.5		V
Bootstrap diode VF @ 100mA	$V_{F2}$			0.9		V
Bootstrap diode dynamic R	$R_D$	@ 100mA		2.5		$\Omega$
<b>Low Side Gate Driver</b>						
Low level output voltage	$V_{OLL}$	$I_O = 100mA$		0.15	0.22	V
High level output voltage to rail	$V_{OHL}$	$I_O = -100mA$		0.45	0.6	V
Peak pull-up current	$I_{OHL}$	$V_{DRVL} = 0V, V_{DD} = 12V$		1.5		A
		$V_{DRVL} = 0V, V_{DD} = 16V$		2.5		A
Peak pull-down current	$I_{OLL}$	$V_{DRVL} = V_{DD} = 12V$		2.5		A
		$V_{DRVL} = V_{DD} = 16V$		3.5		A
<b>Floating Gate Driver</b>						
Low level output voltage	$V_{OLH}$	$I_O = 100mA$		0.15	0.22	V
High level output voltage to rail	$V_{OHH}$	$I_O = -100mA$		0.45	0.6	V
Peak pull-up current	$I_{OHH}$	$V_{DRVH} = 0V, V_{DD} = 12V$		1.5		A
		$V_{DRVH} = 0V, V_{DD} = 16V$		2.5		A
Peak pull-down current	$I_{OLH}$	$V_{DRVH} = V_{DD} = 12V$		2.5		A
		$V_{DRVH} = V_{DD} = 16V$		3.5		A

**ELECTRICAL CHARACTERISTICS (continued)**
 $V_{DD} = V_{BST} - V_{SW} = 12V$ ,  $V_{SS} = V_{SW} = 0V$ , No load at DRVH and DRVL,  $T_A = 25^\circ C$ , unless otherwise noted.

Parameter	Symbol	Condition	Min	Typ	Max	Units
<b>Switching Spec. --- Low Side Gate Driver</b>						
Turn-off propagation delay INL falling to DRVL falling	$T_{DLFF}$			16		ns
Turn-on propagation delay INL rising to DRVL rising	$T_{DLRR}$			16		
DRVL rise time		$C_L = 1nF$		12		ns
DRVL fall time		$C_L = 1nF$		9		ns
<b>Switching Spec. --- Floating Gate Driver</b>						
Turn-off propagation delay INL falling to DRVH falling	$T_{DHFF}$			16		ns
Turn-on propagation delay INL rising to DRVH rising	$T_{DHRR}$			16		ns
DRVH rise time		$C_L = 1nF$		12		ns
DRVH fall time		$C_L = 1nF$		9		ns
<b>Switching Spec. --- Matching</b>						
Floating driver turn-off to low side drive turn-on	$T_{MON}$			1	5	ns
Low side driver turn-off to floating driver turn-on	$T_{MOFF}$			1	5	ns
Minimum input pulse width that changes the output	$T_{PW}$				50 <sup>(5)</sup>	ns
Bootstrap diode turn-on or turn- off time	$T_{BS}$			10 <sup>(5)</sup>		ns

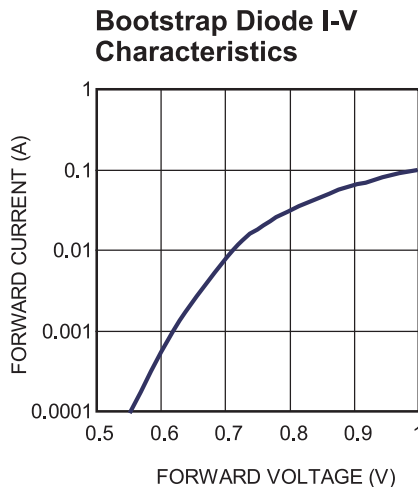
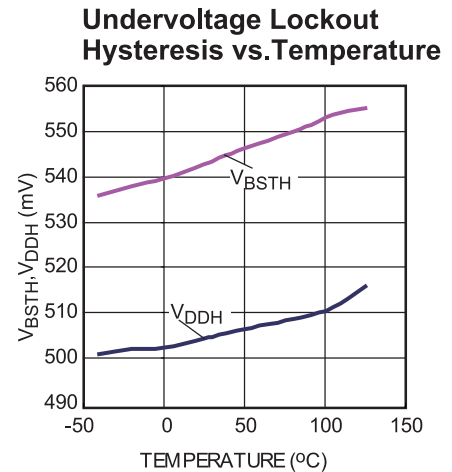
**Note:**

5) Guaranteed by design.

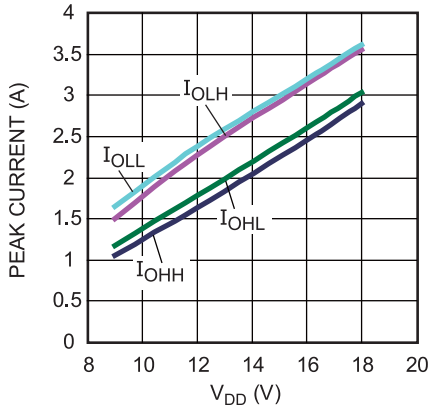
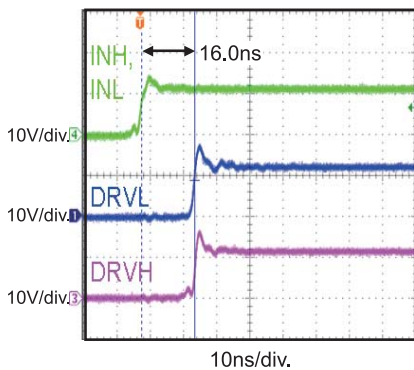
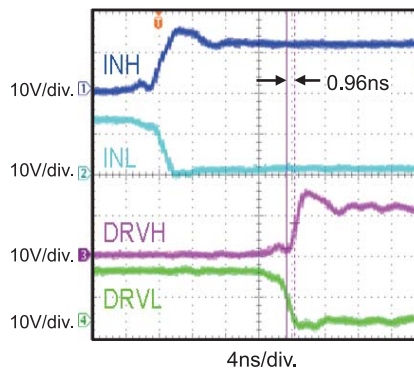
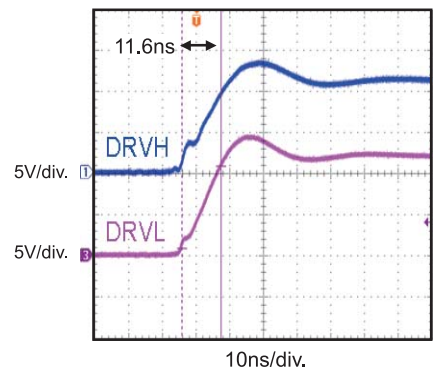
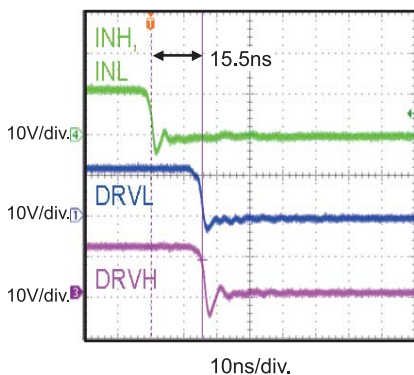

**Figure 1—Timing Diagram**

## TYPICAL PERFORMANCE CHARACTERISTICS

$V_{DD} = 12V$ ,  $V_{SS} = V_{SW} = 0V$ ,  $T_A = 25^\circ C$ , unless otherwise noted.



**TYPICAL PERFORMANCE CHARACTERISTICS (continued)**
 $V_{DD} = 12V, V_{SS} = V_{SW} = 0V, T_A = 25^\circ C$ , unless otherwise noted.

**Peak Current vs.  $V_{DD}$  Voltage**

**Turn-on Propagation Delay**

**Gate Drive Matching  $T_{MOFF}$** 

**Drive Rise Time (1nF Load)**

**Turn-off Propagation Delay**

**Gate Drive Matching  $T_{MON}$** 

**Drive Fall Time (1nF Load)**


**PIN FUNCTIONS**

SOIC8EP, SOIC-8, QFN8(3x3mm)	QFN9 (3x3mm)	QFN10 (4x4mm)	Name	Description
1	1	1	VDD	Supply input. This pin supplies power to all the internal circuitry. A decoupling capacitor to ground must be placed close to this pin to ensure stable and clean supply.
2	2	2	BST	Bootstrap. This is the positive power supply for the internal floating high-side MOSFET driver. Connect a bypass capacitor between this pin and SW pin.
3	3	3	DRVH	Floating driver output.
4	4	4	SW	Switching node.
	5	5,6	NC	No connection.
5	6	7	INH	Control signal input for the floating driver.
6	7	8	INL	Control signal input for the low side driver.
7	8	9	VSS, Exposed Pad	Chip ground. Connect exposed pad to VSS for proper thermal operation.
8	9	10	DRVL	Low side driver output.



BLOCK DIAGRAM



Figure 2—Function Block Diagram

### APPLICATION

The input signals of INH and INL can be controlled independently. If both INH and INL are controlling HSFET and LSFET of the same bridge, then users must avoid shoot through by

setting sufficient dead time between INH and INL low, and vice versa. See below figure. Dead time is defined as the time interval between INH low and INL low.



## REFERENCE DESIGN CIRCUITS

### Half Bridge Converter

In half-bridge converter topology, the MOSFETs are driven alternately with some dead time. Therefore, INH and INL are driven with

alternating signals from the PWM controller. The input voltage can be up to 100V in this application.



**Figure 3 – Half Bridge Converter**

### Two-Switch Forward Converter

In two-switch forward converter topology, both MOSFETs are turned on and off together. The input signal (INH and INL) comes from the PWM controller, which senses the output voltage (and output current if current-mode control is used).

The Schottky diodes clamp the reverse swing of the power transformer and must be rated at the input voltage. The input voltage can be up to 100V in this circuit.



**Figure 4 – Two-Switch Forward Converter**

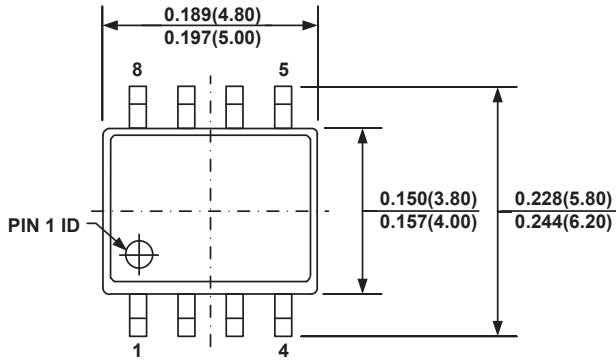
### Active-Clamp Forward Converter

In active-clamp forward converter topology, the MOSFETs are driven alternately. The high-side MOSFET, along with capacitor  $C_{reset}$ , is used to reset the power transformer in a lossless manner.

This topology lends itself well to run at duty cycles exceeding 50%. For these reasons, the input voltage may not be able to run at 100V for this application.



**Figure 5 – Active-Clamp Forward Converter**

**PACKAGE INFORMATION**
**SOIC8E**

**TOP VIEW**

**BOTTOM VIEW**

**FRONT VIEW**

**SIDE VIEW**

**RECOMMENDED LAND PATTERN**

**DETAIL "A"**
**NOTE:**

- 1) CONTROL DIMENSION IS IN INCHES. DIMENSION IN BRACKET IS IN MILLIMETERS.
- 2) PACKAGE LENGTH DOES NOT INCLUDE MOLD FLASH, PROTRUSIONS OR GATE BURRS.
- 3) PACKAGE WIDTH DOES NOT INCLUDE INTERLEAD FLASH OR PROTRUSIONS.
- 4) LEAD COPLANARITY (BOTTOM OF LEADS AFTER FORMING) SHALL BE 0.004" INCHES MAX.
- 5) DRAWING CONFORMS TO JEDEC MS-012, VARIATION BA.
- 6) DRAWING IS NOT TO SCALE.

QFN8 (3×3mm)



**TOP VIEW**



**BOTTOM VIEW**



**SIDE VIEW**

PIN 1 ID OPTION A  
0.30x45° TYP.

PIN 1 ID OPTION B  
R0.20 TYP.



**DETAIL A**



**RECOMMENDED LAND PATTERN**

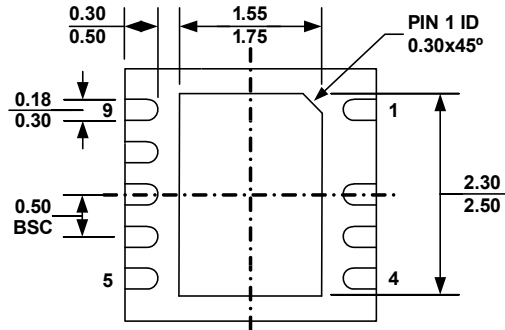
**NOTE:**

- 1) ALL DIMENSIONS ARE IN MILLIMETERS
- 2) EXPOSED PADDLE SIZE DOES NOT INCLUDE MOLD FLASH
- 3) LEAD COPLANARITY SHALL BE 0.10 MILLIMETER MAX
- 4) DRAWING CONFORMS TO JEDEC MO229, VARIATION VEEC-2.
- 5) DRAWING IS NOT TO SCALE

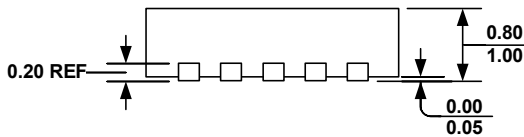
QFN9 (3×3mm)



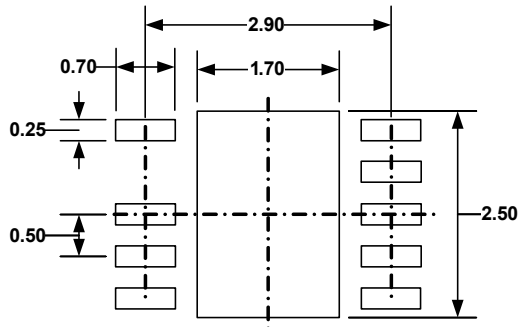
**TOP VIEW**



**BOTTOM VIEW**



**SIDE VIEW**



**RECOMMENDED LAND PATTERN**

**NOTE:**

- 1) ALL DIMENSIONS ARE IN MILLIMETERS
- 2) EXPOSED PADDLE SIZE DOES NOT INCLUDE MOLD FLASH
- 3) LEAD COPLANARITY SHALL BE 0.10 MILLIMETER MAX
- 4) DRAWING CONFORMS TO JEDEC MO-229, VARIATION VEED-5.
- 5) DRAWING IS NOT TO SCALE

**QFN10 (4×4mm)**



TOP VIEW



BOTTOM VIEW

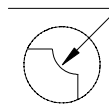


SIDE VIEW

PIN 1 ID OPTION A  
0.30x45° TYP.



PIN 1 ID OPTION B  
R0.25 TYP.



DETAIL A



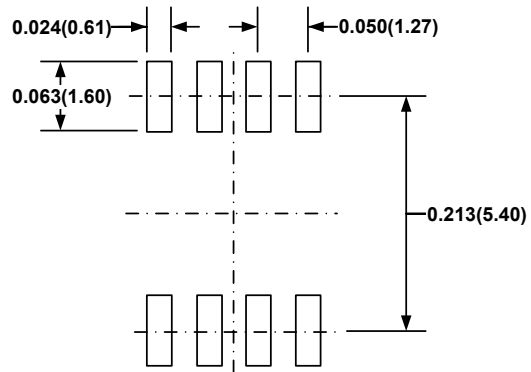
RECOMMENDED LAND PATTERN

NOTE:

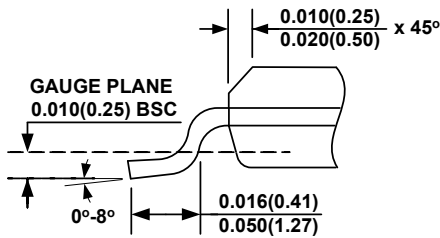
- 1) ALL DIMENSIONS ARE IN MILLIMETERS.
- 2) EXPOSED PADDLE SIZE DOES NOT INCLUDE MOLD FLASH.
- 3) LEAD COPLANARITY SHALL BE 0.10 MILLIMETERS MAX.
- 4) JEDEC REFERENCE IS MO-220.
- 5) DRAWING IS NOT TO SCALE.



**SOIC-8**

**TOP VIEW**

**RECOMMENDED LAND PATTERN**

**FRONT VIEW**

**SIDE VIEW**

**DETAIL "A"**
**NOTE:**

- 1) CONTROL DIMENSION IS IN INCHES. DIMENSION IN BRACKET IS IN MILLIMETERS.
- 2) PACKAGE LENGTH DOES NOT INCLUDE MOLD FLASH, PROTRUSIONS OR GATE BURRS.
- 3) PACKAGE WIDTH DOES NOT INCLUDE INTERLEAD FLASH OR PROTRUSIONS.
- 4) LEAD COPLANARITY (BOTTOM OF LEADS AFTER FORMING) SHALL BE 0.004" INCHES MAX.
- 5) DRAWING CONFORMS TO JEDEC MS-012, VARIATION AA.
- 6) DRAWING IS NOT TO SCALE.

**NOTICE:** The information in this document is subject to change without notice. Users should warrant and guarantee that third party Intellectual Property rights are not infringed upon when integrating MPS products into any application. MPS will not assume any legal responsibility for any said applications.



Компания «ЭлектроПласт» предлагает заключение долгосрочных отношений при поставках импортных электронных компонентов на взаимовыгодных условиях!

Наши преимущества:

- Оперативные поставки широкого спектра электронных компонентов отечественного и импортного производства напрямую от производителей и с крупнейших мировых складов;
- Поставка более 17-ти миллионов наименований электронных компонентов;
- Поставка сложных, дефицитных, либо снятых с производства позиций;
- Оперативные сроки поставки под заказ (от 5 рабочих дней);
- Экспресс доставка в любую точку России;
- Техническая поддержка проекта, помощь в подборе аналогов, поставка прототипов;
- Система менеджмента качества сертифицирована по Международному стандарту ISO 9001;
- Лицензия ФСБ на осуществление работ с использованием сведений, составляющих государственную тайну;
- Поставка специализированных компонентов (Xilinx, Altera, Analog Devices, Intersil, Interpoint, Microsemi, Aeroflex, Peregrine, Syfer, Eurofarad, Texas Instrument, Miteq, Cobham, E2V, MA-COM, Hittite, Mini-Circuits, General Dynamics и др.);

Помимо этого, одним из направлений компании «ЭлектроПласт» является направление «Источники питания». Мы предлагаем Вам помощь Конструкторского отдела:

- Подбор оптимального решения, техническое обоснование при выборе компонента;
- Подбор аналогов;
- Консультации по применению компонента;
- Поставка образцов и прототипов;
- Техническая поддержка проекта;
- Защита от снятия компонента с производства.



#### Как с нами связаться

**Телефон:** 8 (812) 309 58 32 (многоканальный)

**Факс:** 8 (812) 320-02-42

**Электронная почта:** [org@eplast1.ru](mailto:org@eplast1.ru)

**Адрес:** 198099, г. Санкт-Петербург, ул. Калинина, дом 2, корпус 4, литера А.