

**Space-saving  
SSOP 1 Form A type  
with built-in resistor  
40V load voltage**

**PhotoMOS®  
RF SSOP C×R10  
Voltage-sensitive (AQY221FO2V)**

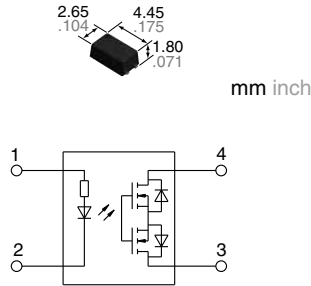

**RoHS compliant**

### FEATURES

**1. Built-in input resistor means less man-hours when mounting**

The voltage-sensitive type, which eliminates the need to mount an external input resistor, is now available in a small package. Man-hours spent mounting external input resistors are cut and board designing is simplified.

**2. Save space on PC board**

Since the small package size remains the same while including a built-in input resistor, space on the PC board is saved. This makes it easier to incorporate space savings when designing miniature devices.

**3. Both low on-resistance (R type) and low capacitance (C type) available at excellent electrical characteristics of C×R10**

- R type: On resistance Typ. 0.75Ω  
Output resistance Typ. 12.5pF
- C type: On resistance Typ. 9.5Ω  
Output capacitance Typ. 1pF

### TYPICAL APPLICATIONS

- 1. Measuring and testing equipment**  
Semiconductor testing equipment, Probe cards, Datalogger, Board tester and other testing equipment.
- 2. Telecommunication and broadcasting equipment**
- 3. Medical equipment**
- 4. Multi-point recorder**  
Data logger, Warming and Thermocouple, etc.

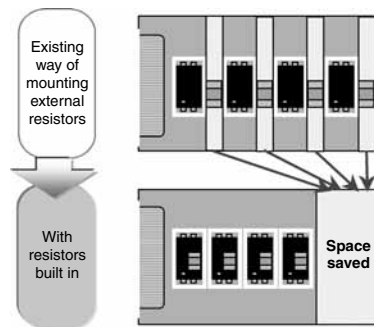

<Artistic impression of PC board space savings due to built-in resistor>

### TYPES

	Type	Output rating*1		Package	Part No.*2		Packing quantity in tape and reel
		Load voltage	Load current		Tape and reel packing style (Picked from the 1 and 4-pin side)	Tape and reel packing style (Picked from the 2 and 3-pin side)	
AC/DC dual use	Low on-resistance (R type)	40 V	0.25A	SSOP	AQY221FR2VY	AQY221FR2VW	3,500 pcs.
	Low capacitance (C type)	40 V	0.12A		AQY221FN2VY	AQY221FN2VW	

Notes: \*1 Indicate the peak AC and DC values.

\*2 Packing quantity of 1,000 pieces is possible. Please contact our sales office.

For space reasons, the three initial letters of the part number "AQY", and the package (SSOP) indicator "V" and the packing style indicator "Y" or "W" are not marked on the device. (Ex. the label for product number AQY221FR2VY is 221FR2)

# RF SSOP C×R10 Voltage-sensitive (AQY221F○2V)

## RATING

### 1. Absolute maximum ratings (Condition: ambient temperature 25°C 77°F)

Item	Symbol	AQY221FR2V	AQY221FN2V	Remarks
Input	Input voltage	$V_{IN}$	6V	
	Input reverse voltage	$V_{RIN}$	5V	
	Power dissipation	$P_{in}$	65mW	
Output	Load voltage (peak AC)	$V_L$	40V	
	Load current	$I_L$	0.25A	0.12A
	Peak load current	$I_{peak}$	0.75A	0.2A
	Power dissipation	$P_{out}$	250mW	
Total power dissipation	$P_T$	300mW		
I/O isolation voltage	$V_{iso}$	500Vrms		
Ambient temperature	Operating	$T_{opr}$	-40 to +85°C -40 to +185°F	(Non-icing at low temperatures)
	Storage	$T_{stg}$	-40 to +100°C -40 to +212°F	

### 2. Electrical characteristics (Condition: ambient temperature 25°C 77°F)

Item	Symbol	AQY221FR2V	AQY221FN2V	Condition		
Input	Operate voltage	Typ.	1.3V	AQY221FR2V: $I_L = \text{Max.}$ AQY221FN2V: $I_L = 80\text{mA}$		
		Max.	4V			
	Turn off voltage	Min.	0.8V			
		Typ.	1.3V			
Input current	Typ.	$I_{IN}$	8.5mA	$V_{IN} = 5V$		
Output	On resistance	Typ.	$R_{on}$	0.75Ω	9.5Ω	AQY221FR2V: $V_{IN} = 5V, I_L = \text{Max.}$ AQY221FN2V: $V_{IN} = 5V, I_L = 80\text{mA}$ Within 1 s
		Max.		1.25Ω	12.5Ω	
	Output capacitance	Typ.	$C_{out}$	12.5pF	1pF	$V_{IN} = 0V, V_B = 0V, f = 1\text{MHz}$
		Max.		18pF	1.5pF	
Off state leakage current	Typ.	$I_{Leak}$	0.02nA	0.01nA	$V_{IN} = 0V, V_L = \text{Max.}$	
	Max.		*10nA			
Transfer characteristics	Turn on time**	Typ.	$T_{on}$	0.05ms	0.01ms	AQY221FR2V: $V_{IN} = 5V, V_L = 10V, R_L = 40\Omega$ AQY221FN2V: $V_{IN} = 5V, V_L = 10V, R_L = 125\Omega$
		Max.		0.5ms		
	Turn off time**	Typ.	$T_{off}$	0.06ms	0.03ms	$f = 1\text{MHz}, V_B = 0V$
		Max.		0.2ms		
	I/O capacitance	Typ.	$C_{iso}$	0.8pF		$f = 1\text{MHz}, V_B = 0V$
		Max.		1.5pF		
Initial I/O isolation resistance	Min.	$R_{iso}$	1,000MΩ		500V DC	

Note: If you wish to change the input voltage, rating or performance, please inquire with our sales.

\*Available as custom orders (1 nA or less)

\*\*Turn on/Turn off time

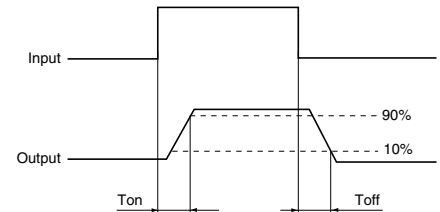

### 3. Recommended operating conditions (Ambient temperature: 25°C 77°F)

Please use under recommended operating conditions to obtain expected characteristics.

Item	Symbol	Min.	Max.	Unit
Input voltage	$V_{IN}$	4.5	5.5	V
AQY221FR2V	Load voltage (Peak AC)	$V_L$	15	V
	Continuous load current	$I_L$	0.25	A
AQY221FN2V	Load voltage (Peak AC)	$V_L$	15	V
	Continuous load current	$I_L$	0.12	A

■ These products are not designed for automotive use.

If you are considering to use these products for automotive applications, please contact your local Panasonic Corporation technical representative.

## REFERENCE DATA

### 1. Load current vs. ambient temperature characteristics

Allowable ambient temperature: -40 to +85°C  
-40 to +185°F

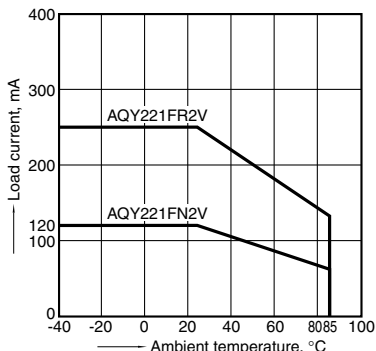

### 2. Load current vs. Load voltage characteristics

Ambient temperature: 25°C 77°F

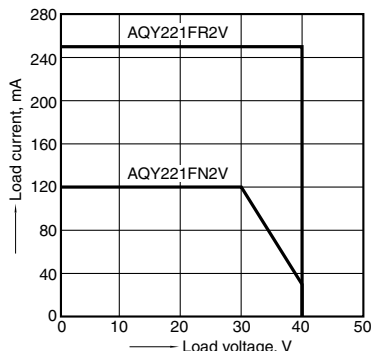

### 3. On resistance vs. ambient temperature characteristics

Measured portion: between terminals 3 and 4  
Input voltage: 5V; Load voltage: 10V (DC);  
Continuous load current: 250mA (DC) R type,  
80mA (DC) C type

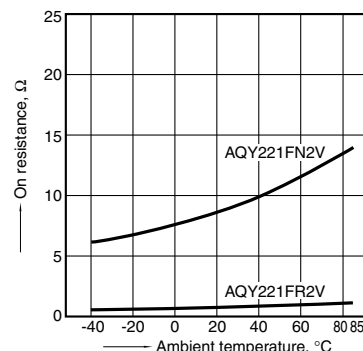

### 4. Turn on time vs. ambient temperature characteristics

Input voltage: 5V; Load voltage: 10V (DC);  
Continuous load current: 250mA (DC) R type,  
80mA (DC) C type

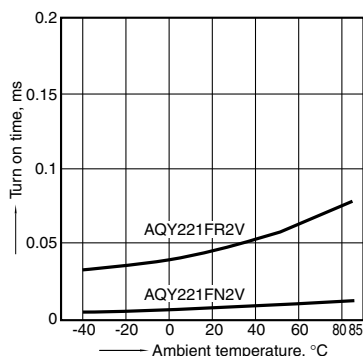

### 5. Turn off time vs. ambient temperature characteristics

Input voltage: 5V; Load voltage: 10V (DC);  
Continuous load current: 250mA (DC) R type,  
80mA (DC) C type

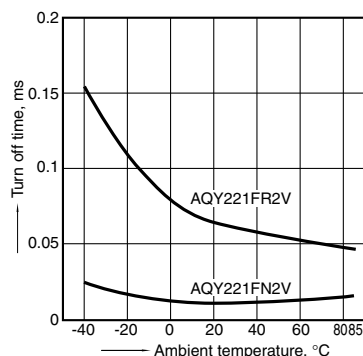

### 6. Operate voltage vs. ambient temperature characteristics

Load voltage: 10V (DC);  
Continuous load current: 250mA (DC) R type,  
80mA (DC) C type

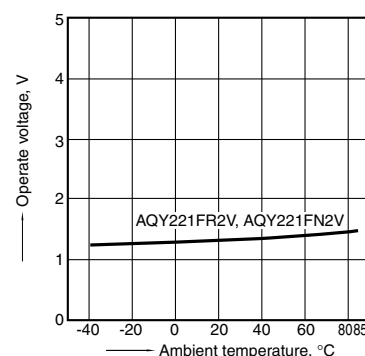

### 7. Turn off voltage vs. ambient temperature characteristics

Load voltage: 10V (DC);  
Continuous load current: 250mA (DC) R type,  
80mA (DC) C type

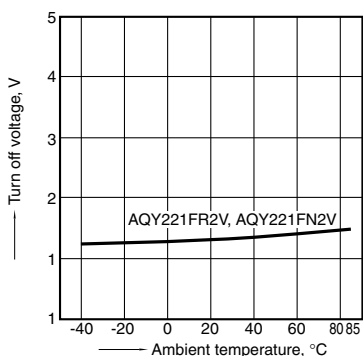

### 8. Input current vs. ambient temperature characteristics

Sample: All types  
Input voltage: 5V

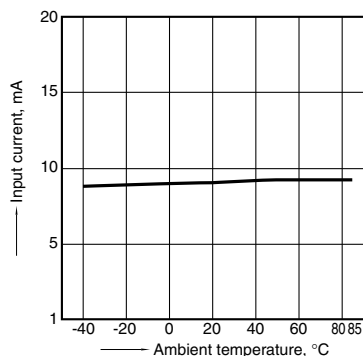

### 9. Current vs. voltage characteristics of output at MOS portion

Measured portion: between terminals 3 and 4  
Ambient temperature: 25°C 77°F

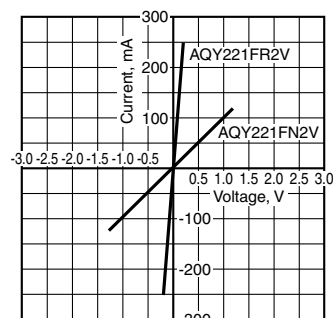

# RF SSOP C×R10 Voltage-sensitive (AQY221F○2V)

## 10. Input current vs. input voltage characteristics

Sample: All types  
Ambient temperature: 25°C 77°F  
(Recommended input voltage: 5±0.5V)

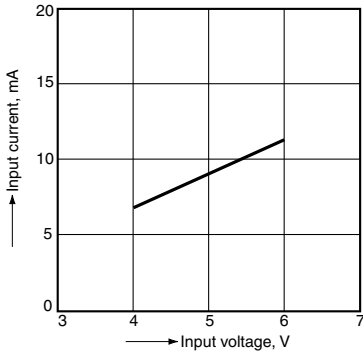

## 11. Off state leakage current vs. load voltage characteristics

Measured portion: between terminals 3 and 4  
Ambient temperature: 25°C 77°F

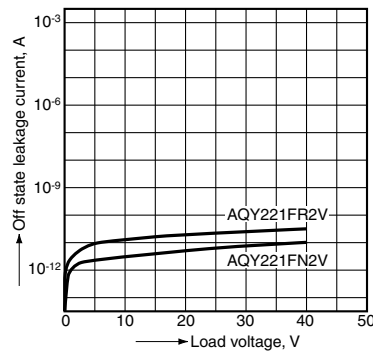

## 12. Turn on time vs. input voltage characteristics

Measured portion: between terminals 3 and 4  
Load voltage: 10V (DC);  
Continuous load current: 250mA (DC) R type,  
80mA (DC) C type; Ambient temperature: 25°C 77°F

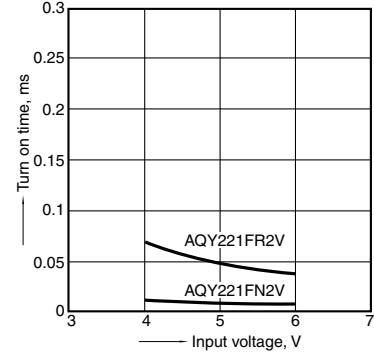

## 13. Turn off time vs. input voltage characteristics

Measured portion: between terminals 3 and 4  
Load voltage: 10V (DC);  
Continuous load current: 250mA (DC) R type,  
80mA (DC) C type; Ambient temperature: 25°C 77°F

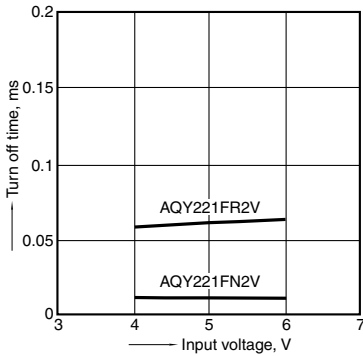

## 14. Output capacitance vs. applied voltage characteristics

Measured portion: between terminals 3 and 4  
Frequency: 1 MHz, 30mVrms;  
Ambient temperature: 25°C 77°F

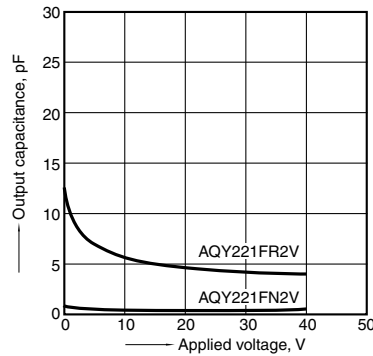

## 15. Isolation vs. frequency characteristics (50Ω impedance)

Measured portion: between terminals 3 and 4  
Ambient temperature: 25°C 77°F

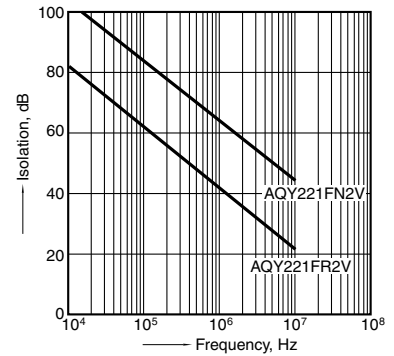

## 16. Insertion loss vs. frequency characteristics (50Ω impedance)

Measured portion: between terminals 3 and 4  
Ambient temperature: 25°C 77°F

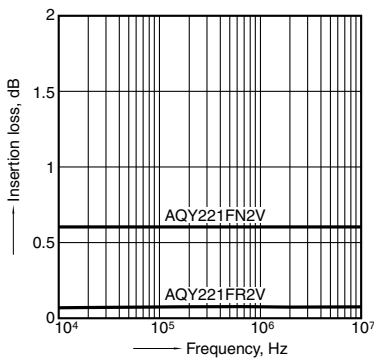

"PhotoMOS®", "PhotoMOS" and "PHOTOMOS" are registered trademarks of Panasonic Corporation.

\*Recognized in Japan, the United States, all member states of European Union and other countries.

Please contact .....

**Panasonic Corporation**

Electromechanical Control Business Division

■ 1006, Oaza Kadoma, Kadoma-shi, Osaka 571-8506, Japan  
[industrial.panasonic.com/ac/e/](http://industrial.panasonic.com/ac/e/)

**Panasonic®**

©Panasonic Corporation 2017

# Mouser Electronics

Authorized Distributor

Click to View Pricing, Inventory, Delivery & Lifecycle Information:

## Panasonic:

[AQY221FR2VW](#) [AQY221FR2VY](#) [AQY221FN2VW](#) [AQY221FN2VY](#) [AQY221FR2V](#) [AQY221FN2V](#) [AQY221FR2V1Y](#)  
[AQY221FN2V1Y](#) [AQY221FN2V1W](#) [AQY221FR2V1W](#)



Компания «ЭлектроПласт» предлагает заключение долгосрочных отношений при поставках импортных электронных компонентов на взаимовыгодных условиях!

Наши преимущества:

- Оперативные поставки широкого спектра электронных компонентов отечественного и импортного производства напрямую от производителей и с крупнейших мировых складов;
- Поставка более 17-ти миллионов наименований электронных компонентов;
- Поставка сложных, дефицитных, либо снятых с производства позиций;
- Оперативные сроки поставки под заказ (от 5 рабочих дней);
- Экспресс доставка в любую точку России;
- Техническая поддержка проекта, помощь в подборе аналогов, поставка прототипов;
- Система менеджмента качества сертифицирована по Международному стандарту ISO 9001;
- Лицензия ФСБ на осуществление работ с использованием сведений, составляющих государственную тайну;
- Поставка специализированных компонентов (Xilinx, Altera, Analog Devices, Intersil, Interpoint, Microsemi, Aeroflex, Peregrine, Syfer, Eurofarad, Texas Instrument, Miteq, Cobham, E2V, MA-COM, Hittite, Mini-Circuits, General Dynamics и др.);

Помимо этого, одним из направлений компании «ЭлектроПласт» является направление «Источники питания». Мы предлагаем Вам помощь Конструкторского отдела:

- Подбор оптимального решения, техническое обоснование при выборе компонента;
- Подбор аналогов;
- Консультации по применению компонента;
- Поставка образцов и прототипов;
- Техническая поддержка проекта;
- Защита от снятия компонента с производства.



#### Как с нами связаться

**Телефон:** 8 (812) 309 58 32 (многоканальный)

**Факс:** 8 (812) 320-02-42

**Электронная почта:** [org@eplast1.ru](mailto:org@eplast1.ru)

**Адрес:** 198099, г. Санкт-Петербург, ул. Калинина, дом 2, корпус 4, литера А.