

## **EMC filters**

3-line filters  
for converters and power electronics

**Series/Type:**        **B84243A**

**Date:**                **July 2018**

© EPCOS AG 2018. Reproduction, publication and dissemination of this publication, enclosures hereto and the information contained therein without EPCOS' prior express consent is prohibited.

EPCOS AG is a TDK Group Company.

**Power line filters for 3-phase systems**
**Rated voltage  $V_R$ : 305/530 V AC**
**Rated current  $I_R$ : 3 A to 280 A**
**Construction**

- 3-line filters
- Metal case

**Features**

- Low leakage current
- Typical performance according to EN 61800-3 + A1(2011):  
C1 up to 25 m respectively C2 up to 50 m motor cable length
- Discharge time up to 44 A types: < 60 V within 1 s
- Short Circuit Current Rating SCCR 100 kA
- Degree of protection: IP 20<sup>1)</sup>
- UL and cUL approval  ENEC approval pending

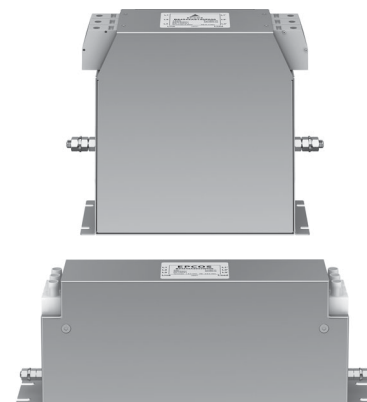
**Typical applications**

- Frequency converters for motor drives, e.g.
  - elevators
  - pumps
  - conveyor systems
  - HVAC systems (heating, ventilation and air conditioning)
- Power supplies
- Textile machines, packaging machines, machine-tools
- Up to 44 A: Plug connected devices

**Terminals**

- Finger-safe terminal blocks

**Marking**

Marking on component:

Manufacturer's logo, ordering code, rated voltage, rated current, rated temperature, climatic category, date code

Minimum data on packaging:

Manufacturer's logo, ordering code, quantity, date code

1) According to IEC 60529

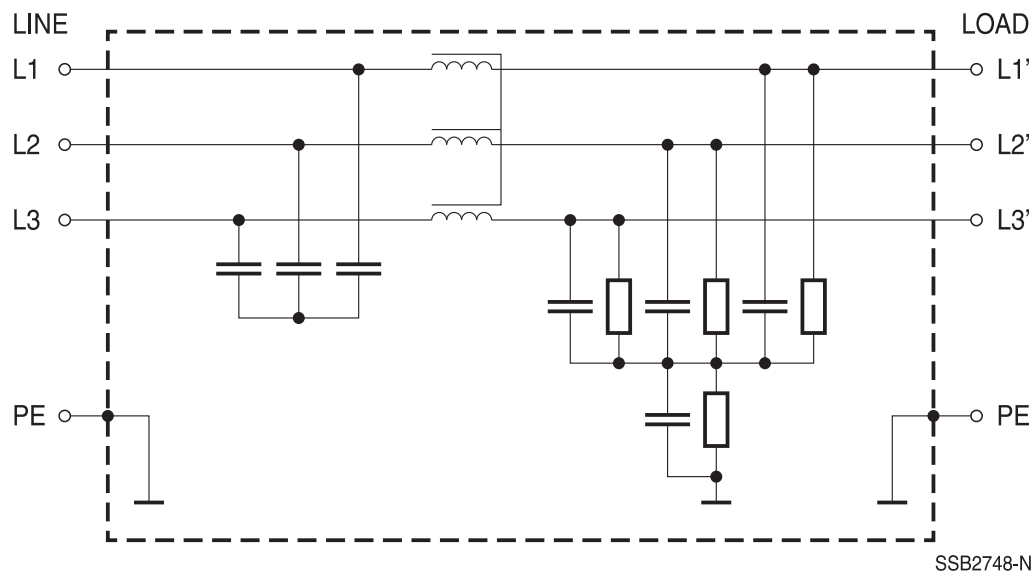
**Typical circuit diagram**

SSB2748-N

**Technical data and measuring conditions**

|                                   |   |
|-----------------------------------|---|
| Rated voltage $V_R$ [L-PE / L-L]  | 305/530 V AC (50/60 Hz)   |
| Rated voltage for IT mains supply | 254/440 V AC (50/60 Hz)<br>See also chapter "General technical information", section 7. |
| Rated current $I_R$               | Referred to 50 °C / 40 °C rated temperature   |
| Test voltage $V_{test}$           | 2240 V DC, 2 s (line/line)<br>2720 V DC, 2 s (lines/case)                               |
| Overload capability (thermal)     | 1.5 · $I_R$ for 3 min per hour or<br>2.5 · $I_R$ for 30 s per hour                      |
| Leakage current $I_{LK}$          | At $V_R$ and 50 Hz  |
| MTBF at $V_R, T_R$                | > 300000 h  |
| Climatic category (IEC 60068-1)   | 25/100/21 (−25 °C/+100 °C/21 days damp heat test)                                       |
| Approvals                         | UL 1283, CSA C22.2 No.8 granted<br>IEC 60939 pending                                    |

**Characteristics and ordering codes**

| $I_R$<br>50 °C<br>A  | $I_R$<br>40 °C<br>A | Terminal<br>cross section<br>mm <sup>2</sup> | $I_{LK}$<br>mA | $R_{typ}$<br>mΩ | Approx.<br>weight<br>kg | Ordering code   | Approvals<br> |   |   |
|----------------------|---------------------|--|----------------|-----------------|-------------------------|-----------------|--|---|---|
| $V_R = 305/530$ V AC |                     |  |                |                 |                         |                 |  |   |   |
| 3                    | 3.5                 | 4  | 2.6            | 40              | 0.5                     | B84243A8003U000 | P  | × | × |
| 8                    | 9                   | 4  | 4.8            | 14              | 0.6                     | B84243A8008W000 | P  | × | × |
| 12                   | 13                  | 4  | 4.8            | 10              | 0.7                     | B84243A8012W000 | P  | × | × |
| 17                   | 19                  | 10   | 4.8            | 7               | 1.2                     | B84243A8017W000 | P  | × | × |
| 25                   | 27                  | 10   | 4.8            | 4               | 1.4                     | B84243A8025W000 | P  | × | × |
| 33                   | 36                  | 10   | 4.8            | 3               | 2.3                     | B84243A8033W000 | P  | × | × |
| 44                   | 48                  | 25   | 6.8            | 2               | 2.6                     | B84243A8044X000 | P  | × | × |
| 60                   | 66                  | 35   | 12             | 1.5             | 2.8                     | B84243A8060W000 | P  | × | × |
| 83                   | 91                  | 50   | 14             | 1.2             | 6                       | B84243A6083Z000 | P  | × | × |
| 90                   | 98                  | 50   | 14             | 1.2             | 6                       | B84243A6090Z000 | P  | × | × |
| 103                  | 113                 | 50   | 14             | 1.2             | 8                       | B84243A6103Z000 | P  | × | × |
| 120                  | 131                 | 50   | 14             | 0.9             | 8                       | B84243A6120Z000 | P  | × | × |
| 140                  | 153                 | 50   | 14             | 0.8             | 11                      | B84243A6140Z000 | P  | × | × |
| 150                  | 164                 | 50   | 14             | 0.8             | 11                      | B84243A6150Z000 | P  | × | × |
| 180                  | 197                 | 95   | 16             | 0.7             | 14                      | B84243A6180Z000 | P  | × | × |
| 220                  | 230                 | 95   | 17             | 0.5             | 15                      | B84243A6220B000 | P  | × | × |
| 275                  | 301                 | 150  | 17             | 0.4             | 17                      | B84243A6275A000 | P  | × | × |
| 280                  | 306                 | 240  | 17             | 0.4             | 17                      | B84243A6280A000 | P  | × | × |

× = Approval granted

P = Approval pending

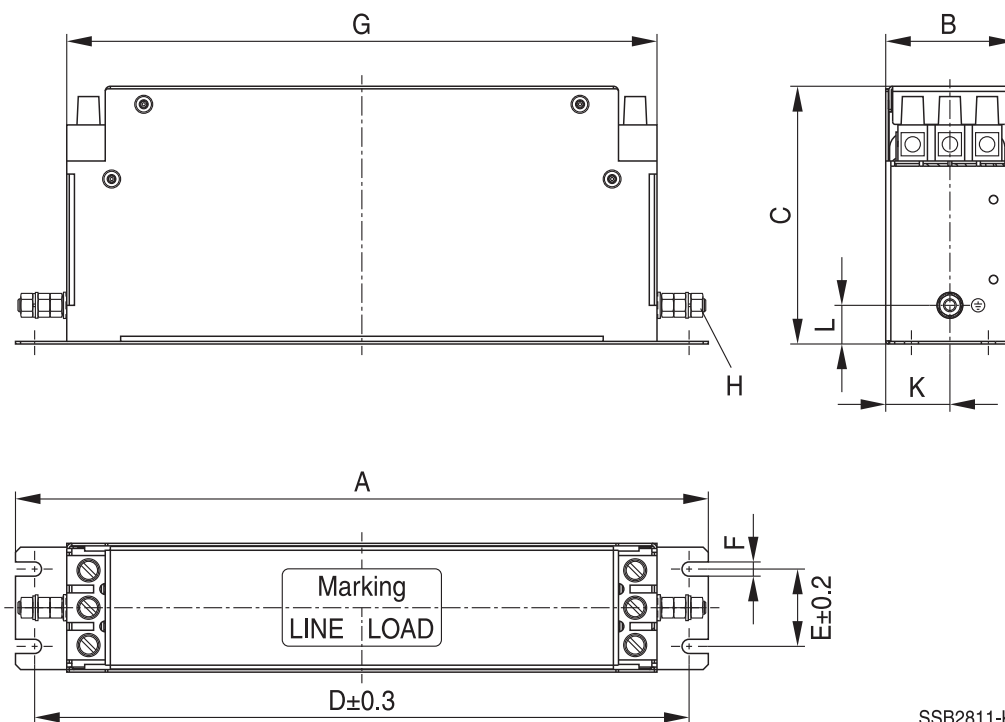
**Dimensional drawings**
**B84243A8003\* ... B84243A8060\* (3 A ... 60 A)**

SSB2811-K

 General tolerances according to ISO 2768–cL  
 Dimensions in mm

| $I_R$<br>A | Dimensions (mm) |    |     |     |    |     |     |    |      |    |
|------------|-----------------|----|-----|-----|----|-----|-----|----|------|----|
|            | A               | B  | C   | D   | E  | F   | G   | H  | K    | L  |
| 3          | 190             | 40 | 95  | 180 | 20 | 5.5 | 160 | M5 | 20   | 15 |
| 8          | 190             | 40 | 95  | 180 | 20 | 5.5 | 160 | M5 | 20   | 15 |
| 12         | 190             | 40 | 95  | 180 | 20 | 5.5 | 160 | M5 | 20   | 15 |
| 17         | 250             | 45 | 85  | 235 | 25 | 5.5 | 210 | M5 | 22.5 | 15 |
| 25         | 270             | 50 | 100 | 255 | 30 | 5.5 | 230 | M5 | 25   | 15 |
| 33         | 270             | 50 | 100 | 255 | 30 | 5.5 | 230 | M5 | 25   | 15 |
| 44         | 310             | 50 | 95  | 295 | 30 | 5.5 | 280 | M6 | 25   | 15 |
| 60         | 250             | 85 | 120 | 235 | 60 | 6.5 | 210 | M6 | 42.5 | 15 |

**Tightening torque in Nm**

| Terminal      | PE            |
|---------------|---------------|
| $0.9 \pm 0.1$ | $3.0 \pm 0.1$ |
| $0.9 \pm 0.1$ | $3.0 \pm 0.1$ |
| $0.9 \pm 0.1$ | $3.0 \pm 0.1$ |
| $2.0 \pm 0.1$ | $3.0 \pm 0.1$ |
| $2.0 \pm 0.1$ | $3.0 \pm 0.1$ |
| $2.0 \pm 0.1$ | $3.0 \pm 0.1$ |
| $2.0 \pm 0.1$ | $5.0 \pm 0.1$ |
| $2.0 \pm 0.1$ | $5.0 \pm 0.1$ |

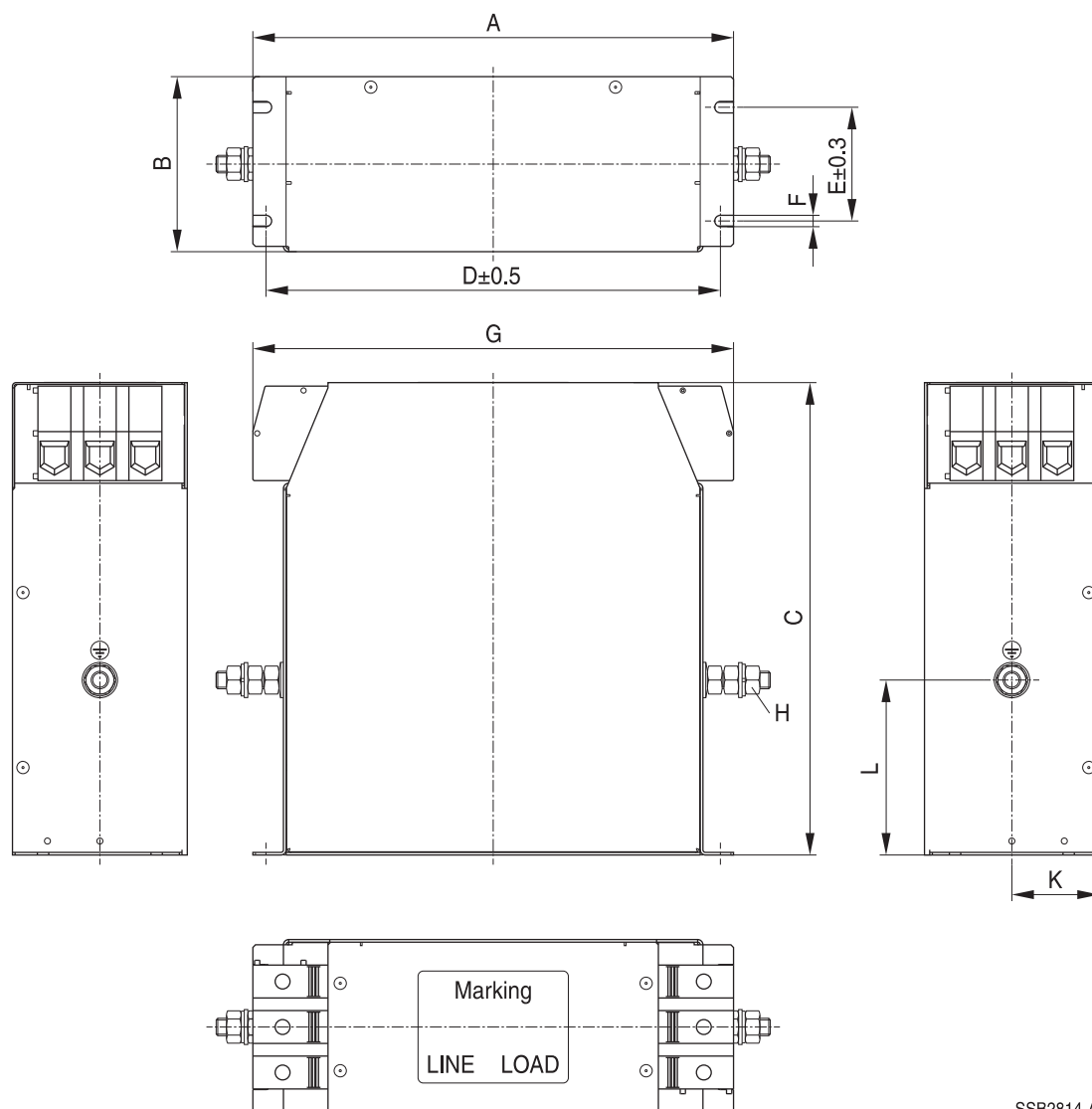
**B84243A6083\* ... B84243A6220\* (83 A ... 220 A)**

SSB2814-A

 General tolerances according to ISO 2768–cL  
 Dimensions in mm

| I <sub>R</sub><br>A | Dimensions (mm) |     |     |     |     |     |     |     |      |     |
|---------------------|-----------------|-----|-----|-----|-----|-----|-----|-----|------|-----|
|                     | A               | B   | C   | D   | E   | F   | G   | H   | K    | L   |
| 83                  | 270             | 80  | 185 | 255 | 60  | 6.5 | 270 | M8  | 40   | 80  |
| 90                  | 270             | 80  | 185 | 255 | 60  | 6.5 | 270 | M8  | 40   | 80  |
| 103                 | 270             | 105 | 190 | 255 | 65  | 6.5 | 270 | M10 | 52.5 | 100 |
| 120                 | 270             | 105 | 190 | 255 | 65  | 6.5 | 270 | M10 | 52.5 | 100 |
| 140                 | 275             | 100 | 270 | 260 | 65  | 6.5 | 275 | M10 | 50   | 100 |
| 150                 | 275             | 100 | 270 | 260 | 65  | 6.5 | 275 | M10 | 50   | 100 |
| 180                 | 380             | 120 | 210 | 365 | 102 | 6.5 | 379 | M10 | 60   | 30  |
| 220                 | 380             | 120 | 210 | 365 | 102 | 6.5 | 379 | M10 | 60   | 30  |

| Tightening torque in Nm |          |
|-------------------------|----------|
| Terminal                | PE       |
| 7.0 ±1                  | 6.0 ±0.3 |
| 7.0 ±1                  | 6.0 ±0.3 |
| 7.0 ±1                  | 10 ±1    |
| 7.0 ±1                  | 10 ±1    |
| 7.0 ±1                  | 10 ±1    |
| 7.0 ±1                  | 10 ±1    |
| 17.5 ±2.5               | 10 ±1    |
| 17.5 ±2.5               | 10 ±1    |

B84243A6275A000 (275 A)

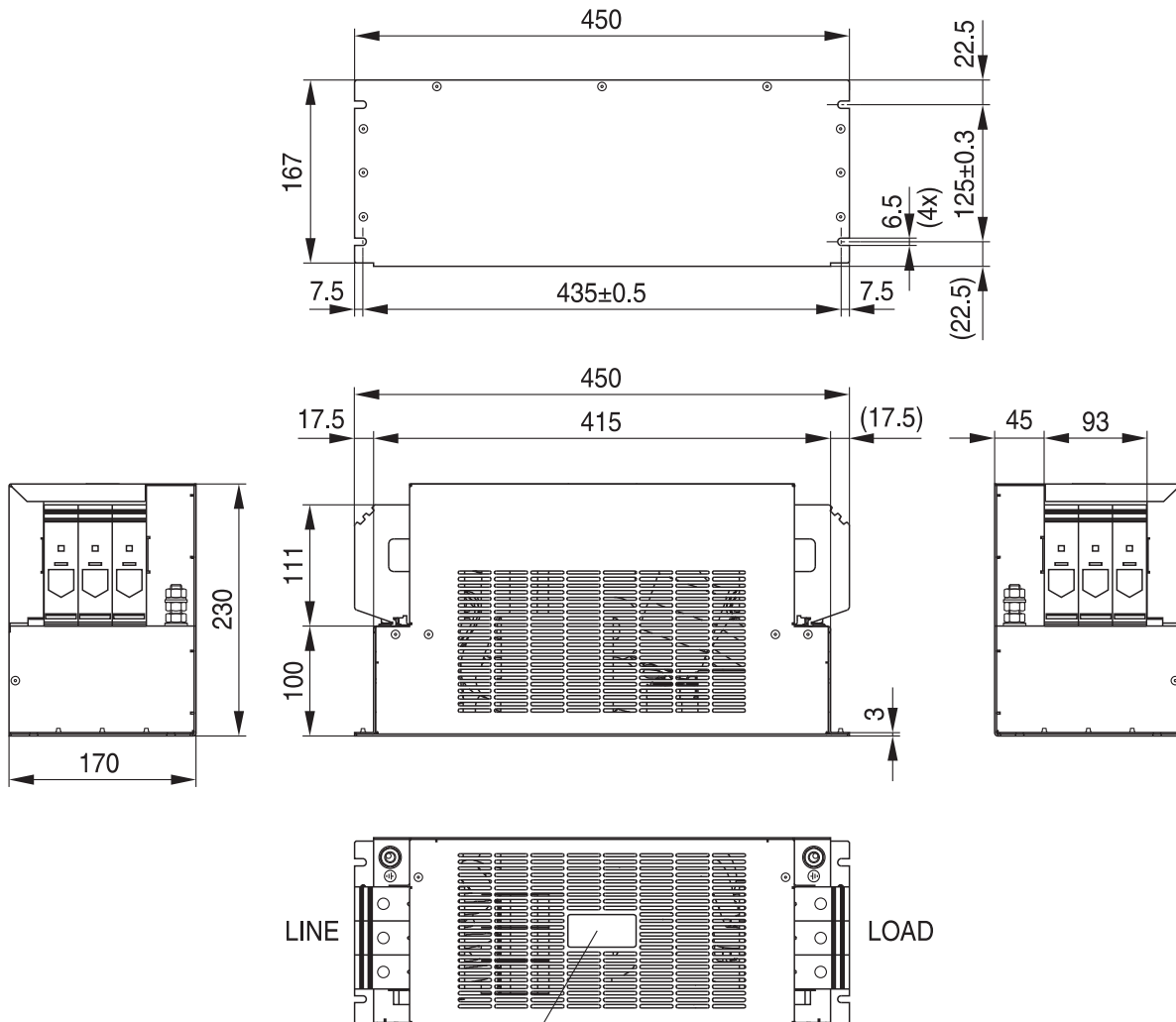

Marking  
Dimensional drawing

SSB3052-P-E

General tolerances according to ISO 2768-cL  
Dimensions in mm

Tightening torque in Nm

| Terminal  | PE    |
|-----------|-------|
| 27.5 ±2.5 | 10 ±1 |

B84243A6280A000 (280 A)

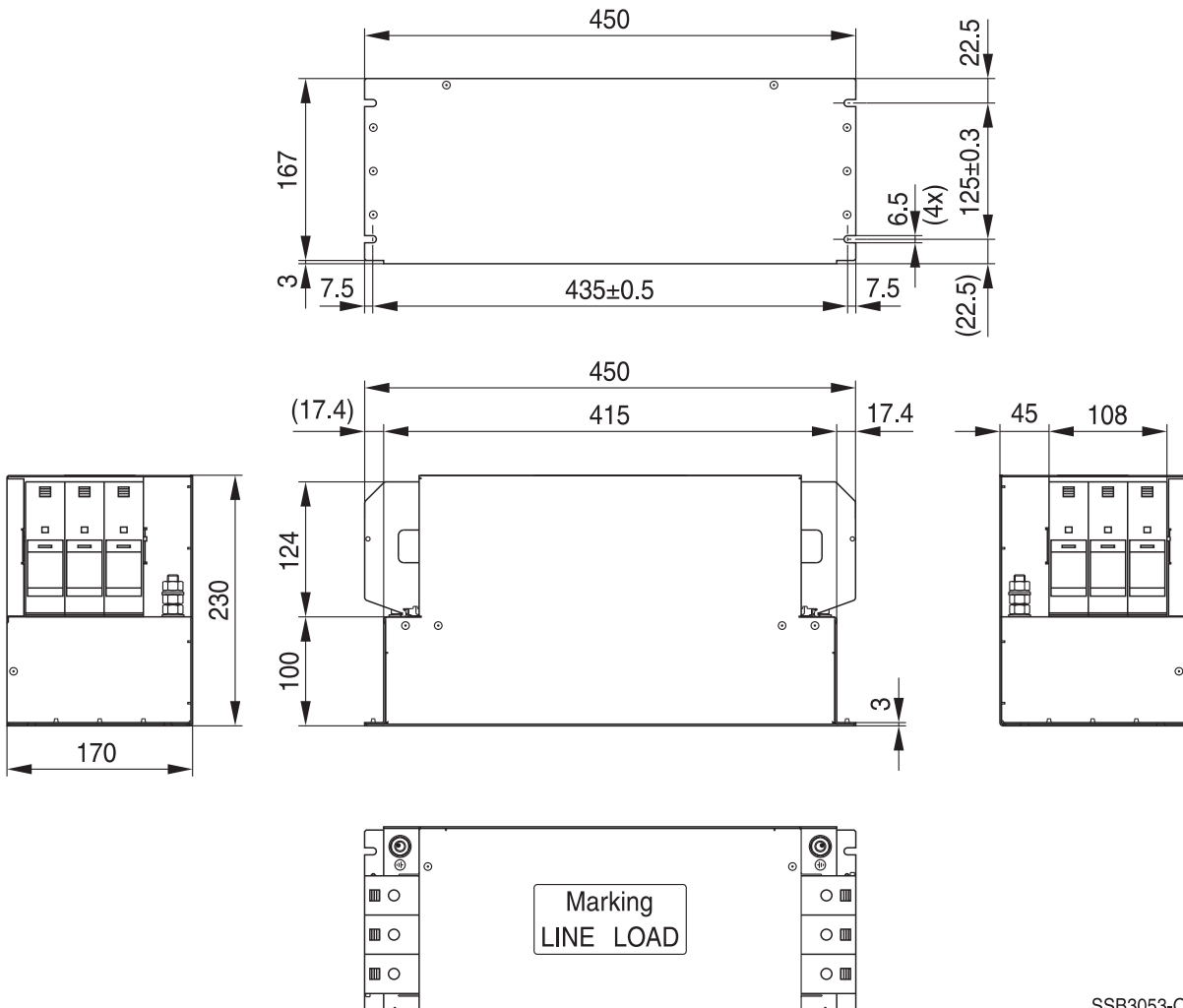

SSB3053-Q

General tolerances according to ISO 2768–cL  
Dimensions in mm

| Tightening torque in Nm |       |
|-------------------------|-------|
| Terminal                | PE    |
| 27.5 ±2.5               | 10 ±1 |



**Insertion loss** (typical values at  $Z = 50 \Omega$ )

- unsymmetrical, adjacent branches terminated
- - - - - common mode, all branches in parallel (asymmetrical)
- - - - - differential mode (symmetrical)

Filters for 3 A to 12 A

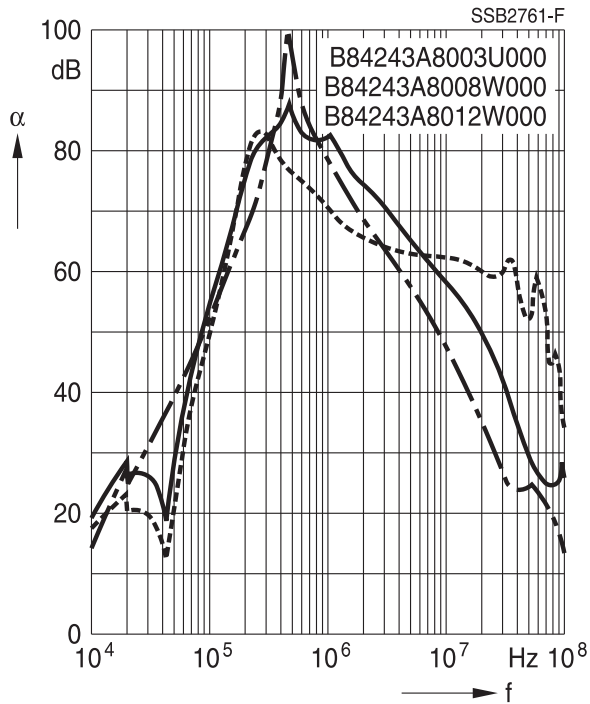

Filters for 17 A and 25 A

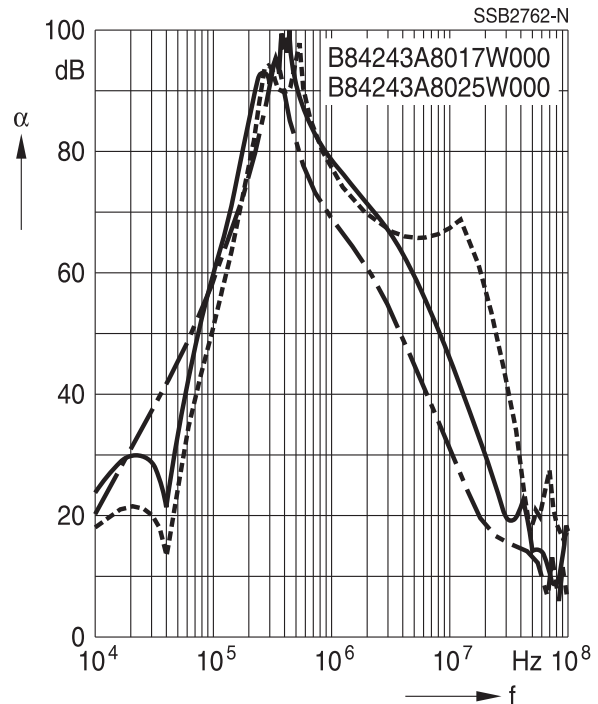

Filters for 33 A and 44 A

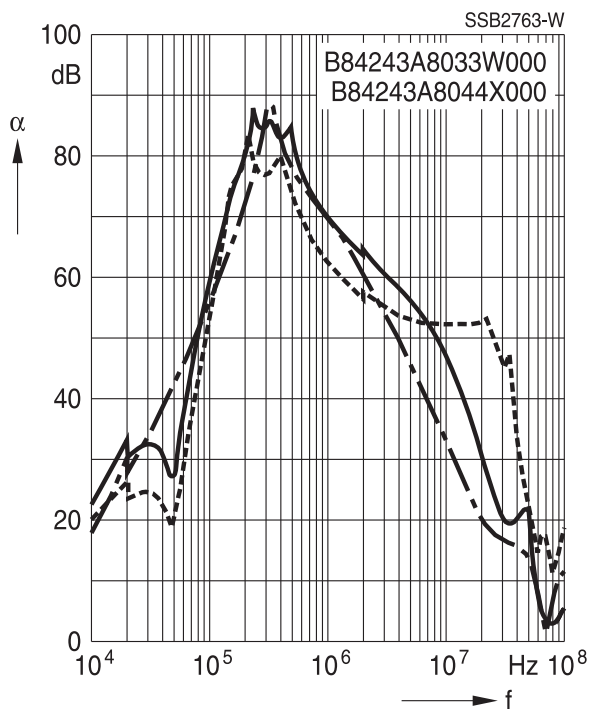

Filter for 60 A

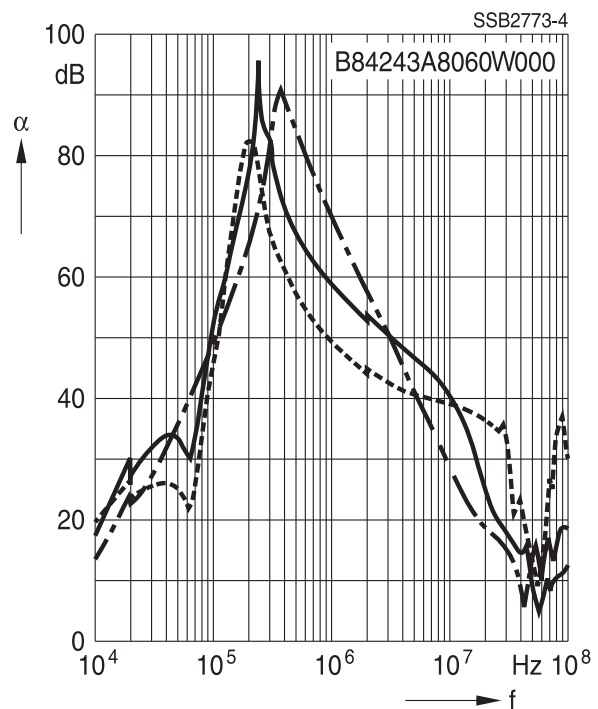

**Insertion loss** (typical values at  $Z = 50 \Omega$ )

- unsymmetrical, adjacent branches terminated
- - - - - common mode, all branches in parallel (asymmetrical)
- - - - - differential mode (symmetrical)

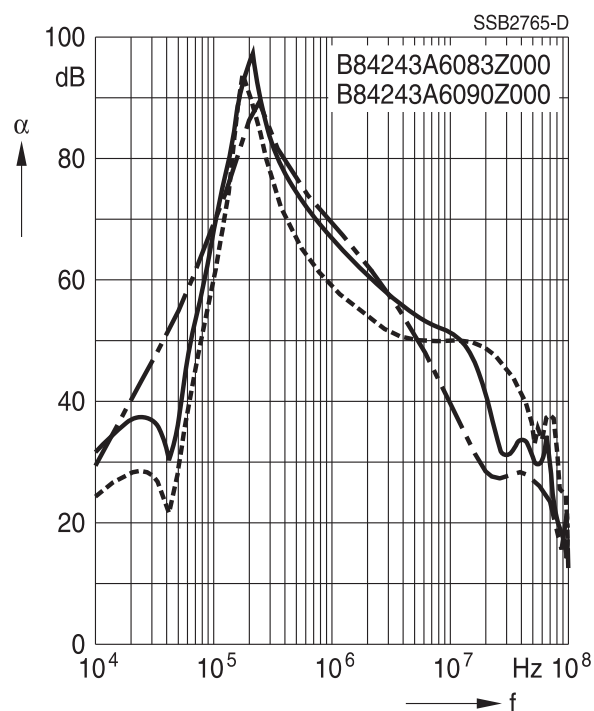
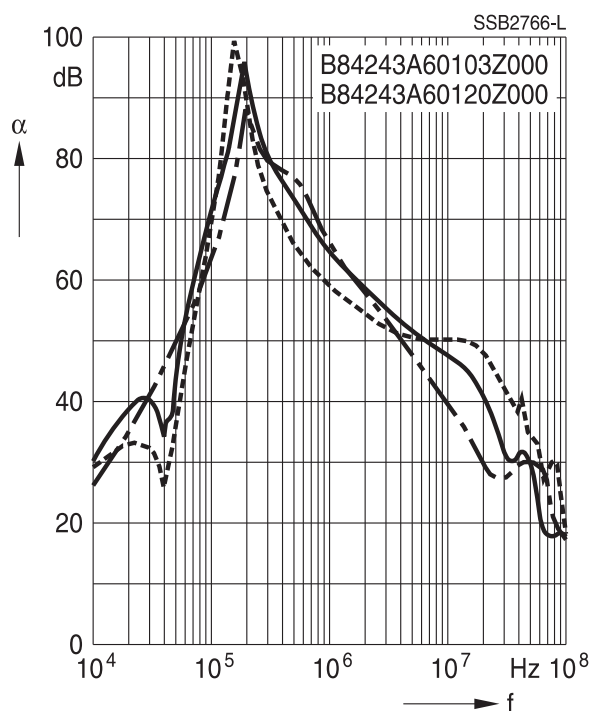
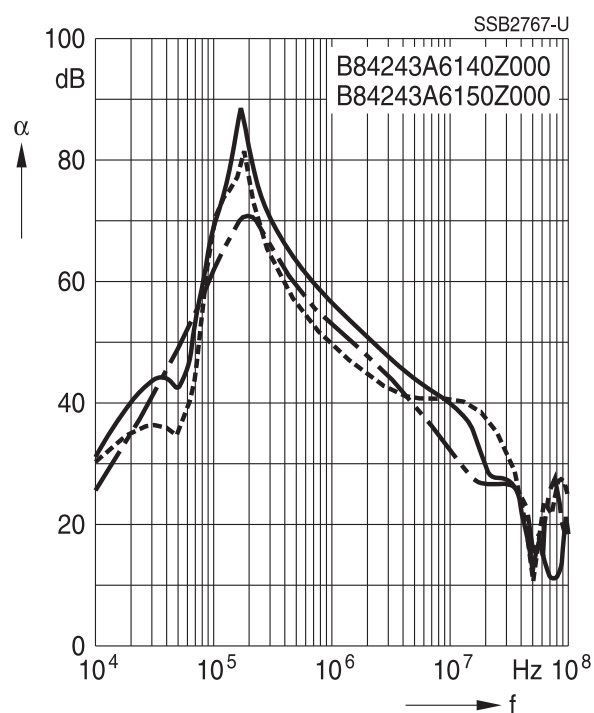
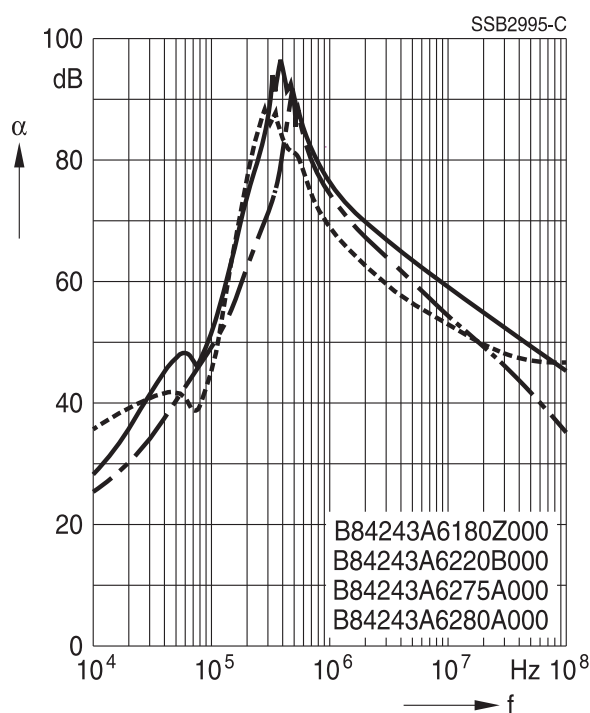
**Filters for 83 A and 90 A**

**Filters for 103 A and 120 A**

**Filters for 140 A and 150 A**

**Filters for 180 A to 280 A**

## Cautions and warnings

Please read all safety and warning notes carefully before installing the filter and putting it into operation (see ). The same applies to the warning signs on the filter. Please ensure that the signs are not removed nor their legibility impaired by external influences.

Death, serious bodily injury and substantial material damage to equipment may occur if the appropriate safety measures are not carried out or the warnings in the text are not observed.

## Using according to the terms

The filters may be used only for their intended application within the specified values in low-voltage networks in compliance with the instructions given in the data sheets and the data book. The conditions at the place of application must comply with all specifications for the filter used.

### Warning

- It shall be ensured that only qualified persons (electricity specialists) are engaged on work such as planning, assembly, installation, operation, repair and maintenance. They must be provided with the corresponding documentation.
- Danger of electric shock. Filters contain components that store an electric charge. Dangerous voltages can continue to exist at the filter terminals for longer than five minutes even after the power has been switched off.
- The protective earth connections shall be the first to be made when the filter is installed and the last to be disconnected. Depending on the magnitude of the leakage currents, the particular specifications for making the protective earth connection must be observed.
- Impermissible overloading of the filter or filter, such as with circuits able to cause resonances, impermissible voltages at higher frequencies etc. can lead to bodily injury and death as well as cause substantial material damages (e.g. destruction of the filter housing).
- Filters must be protected in the application against impermissible exceeding of the rated currents by overcurrent protective devices.
- In case of leakage currents  $>3.5$  mA you shall mount the PE conductor stationary with the required cross section before beginning of operation and save it against disconnecting. For leakage currents  $I_L^{1)} \leq 10$  mA the PE conductor must have a KU value<sup>2)</sup> of 4.5<sup>3)</sup>; for leakage currents  $I_L > 10$  mA the PE conductor must have a KU value of 6<sup>4)</sup>.
- Output chokes and output filters must be protected in the application against impermissible exceeding of the component temperature.
- The converter output frequency must be within the specified range to avoid resonances and uncontrolled warming of the output chokes and output filters.
- Because the product can become very hot during operation, there is the risk of burns if touched. The product can remain hot for some time after the power is switched off!

1)  $I_L$  = leakage current let-go

2) The KU value (symbol KU) is a classification parameter of safety-referred failure types designed to ensure protection against hazardous body currents and excessive heating.

3) A value of KU = 4.5 with respect to interruptions is attained with: a) permanently connected protective earth connection  $\geq 1.5$  mm<sup>2</sup> and b) a protective earth connection  $\geq 2.5$  mm<sup>2</sup> via connectors for industrial equipment (IEC 60309-2)

4) KU = 6 with respect to interruptions is achieved for fixed-connection lines  $\geq 10$  mm<sup>2</sup> where the type of connection and installation correspond to the requirements for PEN conductors as specified in relevant standards.

The table below summarizes the safety instructions that must be observed without fail. A detailed description can be found in the relevant chapters of the databook.

| <b>Topic</b>  | <b>Instructions</b>   | <b>Reference chapter (data book), paragraph</b>        |
|---|---|--|
| Selecting a filter  | When selecting a filter, it is mandatory to observe the rated data of the equipment (such as its rated input current, rated voltage, harmonic content etc.) as well as the derating instructions in Chapters 9 and 10.  | Selection guide for converter filters                  |
| Rated voltage   | When power distribution systems deviating from the symmetric TN-S system is to check the suitability of the filters and the allowed voltages including the fault cases.   | Power distribution systems, 7                          |
| Protection from residual voltages<br>Discharge resistors      | Active parts must be discharged within 5 s to a voltage of less than 60 V (or 50 $\mu$ C). If this limit cannot be observed due to the operating mode, the hazardous point must be permanently marked in a clearly visible way.<br><br>Filters which are not permanently connected (e.g. when the test voltage is applied to the filter at the incoming goods inspection) must be discharged after the voltage has been switched off. | Safety regulations, 6.1<br><br>Safety regulations, 6.2 |
| Installing and removing of filters<br>Installation            | When installing and removing our filters, a voltage-free state must be set up and secured with observance of the five safety rules described in EN 50110-1.   | Safety regulations, 6.4                                |
| Use in IT systems   | The special features of the IT system ("first fault case" and other fault cases) shall be observed.   | Power distribution system (network types), 7.6         |
| Safety notes on leakage currents                              | The filter leakage currents specified in the data book are intended for user information only. The maximum leakage current of the entire electrical equipment or appliance has to be limited for safety reasons. Please obtain the applicable limits for your application from the relevant regulations, provisions and standards.  | Leakage current, 8.4<br>Leakage current, 8.6           |
| Voltage derating<br>Hazards caused by overloading the filters | If the permissible limits for the higher-frequency voltages at the filter are exceeded, the filter may be damaged or destroyed.   | Voltage derating, 9.8                                  |
| Current derating at elevated ambient temperatures             | Non-observance of the current derating may lead to overheating and consequently represents a fire hazard.   | Current derating, 10.1                                 |

| Topic  | Instructions   | Reference chapter (data book), paragraph |
|--|--|--|
| Protective earth connection at operating currents >250 A | For operating currents greater than 250 A, we recommend the PE connection to be set up between the feed (filter: line) and output (filter: load) not via the PE terminal bolt in the filter housing.   | Mounting instructions, point 2           |
| Mounting position  | Note the mounting position of the filters! It must always be ensured that natural convection is not impaired.  | Mounting instructions, point 13          |
| Long motor cables  | Long motor cables cause parasitic currents in the installation. The cable lengths indicated for the output chokes and output filters serve for orientation. The user must check the technical parameters and especially the choke temperatures for the respective application. | Mounting instructions, point 15          |

### Display of ordering codes for EPCOS products

The ordering code for one and the same product can be represented differently in data sheets, data books, other publications and the website of EPCOS, or in order-related documents such as shipping notes, order confirmations and product labels. The varying representations of the ordering codes are due to different processes employed and do not affect the specifications of the respective products.

Detailed information can be found on the Internet under [www.epcos.com/orderingcodes](http://www.epcos.com/orderingcodes).

**Symbols and terms**

| Symbol      | English                                       | German                           |
|-------------|---|----------------------------------|
| $\alpha$    | Insertion loss                                | Einfügungsdämpfung               |
| $C_R$       | Rated capacitance                             | Bemessungskapazität              |
| $C_X$       | Capacitance X capacitor                       | Kapazität X-Kondensator          |
| $C_Y$       | Capacitance Y capacitor                       | Kapazität Y-Kondensator          |
| $\Delta V$  | Voltage drop (input to output)                | Spannungsabfall im Filter        |
| $dv/dt$     | Rate of voltage rise                          | Spannungsanstiegsgeschwindigkeit |
| $f$         | Frequency                                     | Frequenz                         |
| $f_M$       | Converter output frequency                    | Motorfrequenz                    |
| $f_P$       | Pulse frequency                               | Pulsfrequenz                     |
| $f_R$       | Rated frequency                               | Bemessungsfrequenz               |
| $f_{res}$   | Resonant frequency                            | Resonanzfrequenz                 |
| $I_C$       | Current through capacitor                     | Strom durch Kondensator          |
| $I_{LK}$    | Filter leakage current                        | Filter-Ableitstrom               |
| $I_{max}$   | Maximum current                               | Maximalstrom                     |
| $I_N$       | Nominal current                               | Nennstrom                        |
| $I_{op}$    | Operating current (design current)            | Betriebsstrom                    |
| $I_{pk}$    | Rated peak withstand current                  | Bemessungs-Stoßstromfestigkeit   |
| $I_q$       | Capacitive reactive current                   | Kapazitiver Blindstrom           |
| $I_R$       | Rated current                                 | Bemessungsstrom                  |
| $I_S$       | Interference current                          | Störstrom                        |
| $L$         | Inductance                                    | Induktivität                     |
| $L_R$       | Rated inductance                              | Bemessungsinduktivität           |
| $L_{stray}$ | Stray inductance                              | Streuinduktivität                |
| $P_L$       | Power loss                                    | Verlustleistung                  |
| $R$         | Resistance                                    | Widerstand                       |
| $R_{is}$    | Insulation resistance                         | Isolationswiderstand             |
| $R_{typ}$   | DC resistance, typical value                  | Gleichstromwiderstand, Richtwert |
| $T_A$       | Ambient temperature                           | Umgebungstemperatur              |
| $T_{max}$   | Upper category temperature                    | Obere Kategorietemperatur        |
| $T_{min}$   | Lower category temperature                    | Untere Kategorietemperatur       |
| $T_R$       | Rated temperature                             | Bemessungstemperatur             |
| $u_k$       | Referred voltage drop in %                    | Bezogener Spannungsabfall in %   |
| $V_{eff}$   | RMS voltage                                   | Effektivspannung                 |
| $V_K$       | Voltage drop                                  | Spannungsabfall                  |
| $V_{LE}$    | Voltage line to earth; voltage line to ground | Spannung Phase zu Erdpotential   |
| $V_N$       | Nominal voltage                               | Nennspannung                     |
| $V_R$       | Rated voltage                                 | Bemessungsspannung               |
| $V_{peak}$  | Peak voltage                                  | Spitzenspannung                  |
| $V_{test}$  | Test voltage                                  | Prüfspannung                     |
| $V_X$       | Voltage over X capacitor                      | Spannung über X-Kondensator      |
| $V_Y$       | Voltage over Y capacitor                      | Spannung über Y-Kondensator      |
| $X_L$       | Inductive reactance                           | Induktiver Blindwiderstand       |
| $Z$         | Impedance                                     | Scheinwiderstand                 |
| $ Z $       | Impedance, absolute value                     | Scheinwiderstand (Betragswert)   |

## Important notes

The following applies to all products named in this publication:

1. Some parts of this publication contain **statements about the suitability of our products for certain areas of application**. These statements are based on our knowledge of typical requirements that are often placed on our products in the areas of application concerned. We nevertheless expressly point out **that such statements cannot be regarded as binding statements about the suitability of our products for a particular customer application**. As a rule, EPCOS is either unfamiliar with individual customer applications or less familiar with them than the customers themselves. For these reasons, it is always ultimately incumbent on the customer to check and decide whether an EPCOS product with the properties described in the product specification is suitable for use in a particular customer application.
2. We also point out that **in individual cases, a malfunction of electronic components or failure before the end of their usual service life cannot be completely ruled out in the current state of the art, even if they are operated as specified**. In customer applications requiring a very high level of operational safety and especially in customer applications in which the malfunction or failure of an electronic component could endanger human life or health (e.g. in accident prevention or lifesaving systems), it must therefore be ensured by means of suitable design of the customer application or other action taken by the customer (e.g. installation of protective circuitry or redundancy) that no injury or damage is sustained by third parties in the event of malfunction or failure of an electronic component.
3. **The warnings, cautions and product-specific notes must be observed.**
4. In order to satisfy certain technical requirements, **some of the products described in this publication may contain substances subject to restrictions in certain jurisdictions (e.g. because they are classed as hazardous)**. Useful information on this will be found in our Material Data Sheets on the Internet ([www.epcos.com/material](http://www.epcos.com/material)). Should you have any more detailed questions, please contact our sales offices.
5. We constantly strive to improve our products. Consequently, **the products described in this publication may change from time to time**. The same is true of the corresponding product specifications. Please check therefore to what extent product descriptions and specifications contained in this publication are still applicable before or when you place an order. We also **reserve the right to discontinue production and delivery of products**. Consequently, we cannot guarantee that all products named in this publication will always be available. The aforementioned does not apply in the case of individual agreements deviating from the foregoing for customer-specific products.
6. Unless otherwise agreed in individual contracts, **all orders are subject to the current version of the "General Terms of Delivery for Products and Services in the Electrical Industry" published by the German Electrical and Electronics Industry Association (ZVEI)**.

## Important notes

7. **Our manufacturing sites serving the automotive business apply the IATF 16949 standard.** The IATF certifications confirm our compliance with requirements regarding the quality management system in the automotive industry. Referring to customer requirements and customer specific requirements (“CSR”) TDK always has and will continue to have the policy of respecting individual agreements. Even if IATF 16949 may appear to support the acceptance of unilateral requirements, we hereby like to emphasize that **only requirements mutually agreed upon can and will be implemented in our Quality Management System.** For clarification purposes we like to point out that obligations from IATF 16949 shall only become legally binding if individually agreed upon.
8. The trade names EPCOS, CeraCharge, CeraDiode, CeraLink, CeraPad, CeraPlas, CSMP, CTVS, DeltaCap, DigiSiMic, ExoCore, FilterCap, FormFit, LeaXield, MiniBlue, MiniCell, MKD, MKK, MotorCap, PCC, PhaseCap, PhaseCube, PhaseMod, PhiCap, PowerHap, PQSine, PQvar, SIFERRIT, SIFI, SIKOREL, SilverCap, SIMDAD, SiMic, SIMID, SineFormer, SIOV, ThermoFuse, WindCap are **trademarks registered or pending** in Europe and in other countries. Further information will be found on the Internet at [www.epcos.com/trademarks](http://www.epcos.com/trademarks).

Release 2018-06



# Mouser Electronics

Authorized Distributor

Click to View Pricing, Inventory, Delivery & Lifecycle Information:

## EPCOS / TDK:

[B84243A8025W000](#) [B84243A8033W000](#) [B84243A8003U000](#) [B84243A8060W000](#) [B84243A8044X000](#)  
[B84243A8008W000](#) [B84243A8017W000](#) [B84243A6083Z000](#) [B84243A6090Z000](#) [B84243A6150Z000](#)  
[B84243A6275A000](#) [B84243A6103Z000](#) [B84243A6140Z000](#) [B84243A6280A000](#) [B84243A6180Z000](#)  
[B84243A6220B000](#) [B84243A6120Z000](#) [B84243A8012W000](#)



Компания «ЭлектроПласт» предлагает заключение долгосрочных отношений при поставках импортных электронных компонентов на взаимовыгодных условиях!

Наши преимущества:

- Оперативные поставки широкого спектра электронных компонентов отечественного и импортного производства напрямую от производителей и с крупнейших мировых складов;
- Поставка более 17-ти миллионов наименований электронных компонентов;
- Поставка сложных, дефицитных, либо снятых с производства позиций;
- Оперативные сроки поставки под заказ (от 5 рабочих дней);
- Экспресс доставка в любую точку России;
- Техническая поддержка проекта, помощь в подборе аналогов, поставка прототипов;
- Система менеджмента качества сертифицирована по Международному стандарту ISO 9001;
- Лицензия ФСБ на осуществление работ с использованием сведений, составляющих государственную тайну;
- Поставка специализированных компонентов (Xilinx, Altera, Analog Devices, Intersil, Interpoint, Microsemi, Aeroflex, Peregrine, Syfer, Eurofarad, Texas Instrument, Miteq, Cobham, E2V, MA-COM, Hittite, Mini-Circuits, General Dynamics и др.);

Помимо этого, одним из направлений компании «ЭлектроПласт» является направление «Источники питания». Мы предлагаем Вам помощь Конструкторского отдела:

- Подбор оптимального решения, техническое обоснование при выборе компонента;
- Подбор аналогов;
- Консультации по применению компонента;
- Поставка образцов и прототипов;
- Техническая поддержка проекта;
- Защита от снятия компонента с производства.



#### Как с нами связаться

**Телефон:** 8 (812) 309 58 32 (многоканальный)

**Факс:** 8 (812) 320-02-42

**Электронная почта:** [org@eplast1.ru](mailto:org@eplast1.ru)

**Адрес:** 198099, г. Санкт-Петербург, ул. Калинина, дом 2, корпус 4, литера А.