



Standard Recovery Diodes, 165 A to 230 A (INT-A-PAK Power Modules)



INT-A-PAK

FEATURES

- High voltage
- Electrically isolated by DBC ceramic (Al_2O_3)
- 3500 V_{RMS} isolating voltage
- Industrial standard package
- High surge capability
- Glass passivated chips
- Modules uses high voltage power diodes in four basic configurations
- Simple mounting
- UL approved file E78996 
- Designed and qualified for multiple level
- Material categorization: for definitions of compliance please see www.vishay.com/doc?99912



RoHS
COMPLIANT

PRODUCT SUMMARY	
$I_{F(AV)}$	165 A to 230 A
Type	Modules - Diode, High Voltage
Package	INT-A-PAK
Circuit	Single diode, Two diodes common cathode, Two diodes common cathode, Two diodes doubler circuit

APPLICATIONS

- DC motor control and drives
- Battery chargers
- Welders
- Power converters

MAJOR RATINGS AND CHARACTERISTICS					
SYMBOL	CHARACTERISTICS	VSK.166..	VSK.196..	VSK.236..	UNITS
$I_{F(AV)}$		165	195	230	A
	T_C	100	100	100	$^{\circ}C$
$I_{F(RMS)}$		260	305	360	A
I_{FSM}	50 Hz	4000	4750	5500	
	60 Hz	4200	4980	5765	
I^2t	50 Hz	80	113	151	kA^2s
	60 Hz	73	103	138	
$I^2\sqrt{t}$		798	1130	1516	$kA^2\sqrt{s}$
V_{RRM}		400 to 1600			V
T_J	Range	-40 to +150			$^{\circ}C$

ELECTRICAL SPECIFICATIONS

VOLTAGE RATINGS				
TYPE NUMBER	VOLTAGE CODE	V_{RRM} , MAXIMUM REPETITIVE PEAK REVERSE VOLTAGE V	V_{RSM} , MAXIMUM NON-REPETITIVE PEAK REVERSE VOLTAGE V	I_{RRM} AT 150 $^{\circ}C$ mA
VS-VSK.166 VS-VSK.196 VS-VSK.236	04	400	500	20
	08	800	900	
	12	1200	1300	
	14	1400	1500	
	16	1600	1700	



FORWARD CONDUCTION							
PARAMETER	SYMBOL	TEST CONDITIONS		VSK.166	VSK.196	VSK.236	UNITS
Maximum average on-state current at case temperature	$I_{F(AV)}$	180° conduction, half sine wave		165	195	230	A
				100	100	100	°C
Maximum RMS on-state current	$I_{F(RMS)}$			260	305	360	A
Maximum peak, one-cycle on-state, non-repetitive surge current	I_{FSM}	t = 10 ms	No voltage reapplied	4000	4750	5500	
		t = 8.3 ms	No voltage reapplied	4200	4980	5765	
		t = 10 ms	100 % V_{RRM} reapplied	3350	4000	4630	
		t = 8.3 ms	100 % V_{RRM} reapplied	3500	4200	4850	
Maximum I^2t for fusing	I^2t	t = 10 ms	No voltage reapplied	80	113	151	kA ² s
		t = 8.3 ms	No voltage reapplied	73	103	138	
		t = 10 ms	100 % V_{RRM} reapplied	56	80	107	
		t = 8.3 ms	100 % V_{RRM} reapplied	52	73	98	
Maximum $I^2\sqrt{t}$ for fusing	$I^2\sqrt{t}$	t = 0.1 ms to 10 ms, no voltage reapplied		798	1130	1516	kA ² √s
Low level value of threshold voltage	$V_{F(TO)1}$	(16.7 % $\times \pi \times I_{F(AV)} < I < \pi \times I_{F(AV)}$, T_J maximum)		0.73	0.69	0.7	V
High level value of threshold voltage	$V_{F(TO)2}$	(I > $\pi \times I_{F(AV)}$), T_J maximum)		0.88	0.78	0.83	
Low level value on-state slope resistance	r_{t1}	(16.7 % $\times \pi \times I_{F(AV)} < I < \pi \times I_{F(AV)}$, T_J maximum)		1.5	1.3	1.2	mΩ
High level value on-state	r_{t2}	(I > $\pi \times I_{F(AV)}$), T_J maximum)		1.26	1.2	1.07	
Maximum forward voltage drop	V_{FM}	$I_{FM} = \pi \times I_{F(AV)}$, $T_J = 25^\circ\text{C}$, 180° conduction Average power = $V_{F(TO)} \times I_{F(AV)} + r_f \times (I_{F(RMS)})^2$		1.43	1.38	1.46	V

BLOCKING							
PARAMETER	SYMBOL	TEST CONDITIONS		VSK.166	VSK.196	VSK.236	UNITS
Maximum peak reverse and off-state leakage current	I_{RRM}	$T_J = 150^\circ\text{C}$		20			mA
RMS insulation voltage	V_{INS}	50 Hz, circuit to base, all terminals shorted, t = 1 s		3500			V

THERMAL AND MECHANICAL SPECIFICATIONS						
PARAMETER	SYMBOL	TEST CONDITIONS	VALUES			UNITS
			VSK.166	VSK.196	VSK.236	
Maximum junction operating and storage temperature range	T_J, T_{Stg}		-40 to +150			°C
Maximum thermal resistance, junction to case per junction	R_{thJC}	DC operation	0.2	0.16	0.14	K/W
Maximum thermal resistance, case to heatsink per module	R_{thCS}	Mounting surface smooth, flat and greased	0.05			
Mounting torque $\pm 10\%$	IAP to heatsink busbar to IAP	A mounting compound is recommended and the torque should be rechecked after a period of 3 hours to allow for the spread of the compound. Lubricated threads.	4 to 6			Nm
Approximate weight			200			g
			7.1			oz.
Case style			INT-A-PAK			



ΔR CONDUCTION PER JUNCTION											
DEVICES	SINUSOIDAL CONDUCTION AT T _J MAXIMUM					RECTANGULAR CONDUCTION AT T _J MAXIMUM					UNITS
	180°	120°	90°	60°	30°	180°	120°	90°	60°	30°	
VSK.166	0.025	0.03	0.038	0.055	0.089	0.018	0.031	0.041	0.057	0.089	K/W
VSK.196	0.016	0.019	0.024	0.034	0.053	0.012	0.02	0.026	0.035	0.054	
VSK.236	0.009	0.010	0.014	0.018	0.025	0.008	0.012	0.015	0.019	0.025	

Note

- Table shows the increment of thermal resistance R_{thJC} when devices operate at different conduction angles than DC



Fig. 1 - Current Ratings Characteristics



Fig. 3 - On-State Power Loss Characteristics



Fig. 2 - Current Ratings Characteristics



Fig. 4 - On-State Power Loss Characteristics



Fig. 5 - Maximum Non-Repetitive Surge Current



Fig. 6 - Maximum Non-Repetitive Surge Current



Fig. 7 - On-State Power Loss Characteristics



Fig. 8 - On-State Power Loss Characteristics





Fig. 9 - On-State Power Loss Characteristics



Fig. 10 - Current Ratings Characteristics

Fig. 12 - On-State Power Loss Characteristics

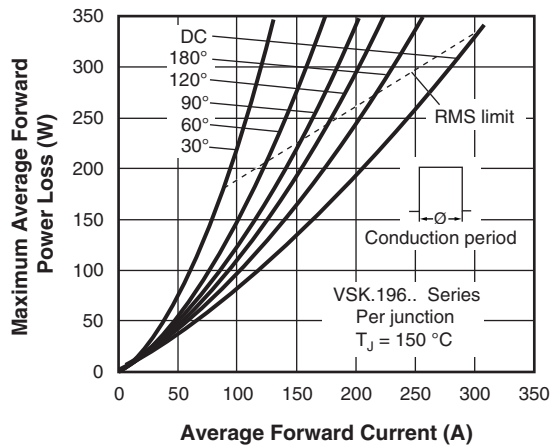
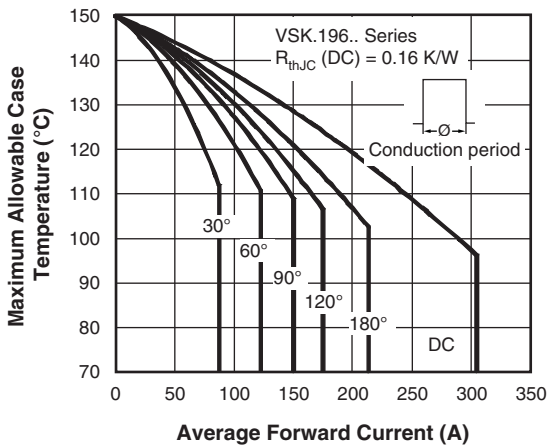

Fig. 11 - Current Ratings Characteristics

Fig. 13 - On-State Power Loss Characteristics



Fig. 14 - Maximum Non-Repetitive Surge Current



Fig. 15 - Maximum Non-Repetitive Surge Current



Fig. 16 - On-State Power Loss Characteristics



Fig. 17 - On-State Power Loss Characteristics





Fig. 18 - On-State Power Loss Characteristics



Fig. 19 - Current Ratings Characteristics



Fig. 21 - On-State Power Loss Characteristics



Fig. 20 - Current Ratings Characteristics



Fig. 22 - On-State Power Loss Characteristics



Fig. 23 - Maximum Non-Repetitive Surge Current

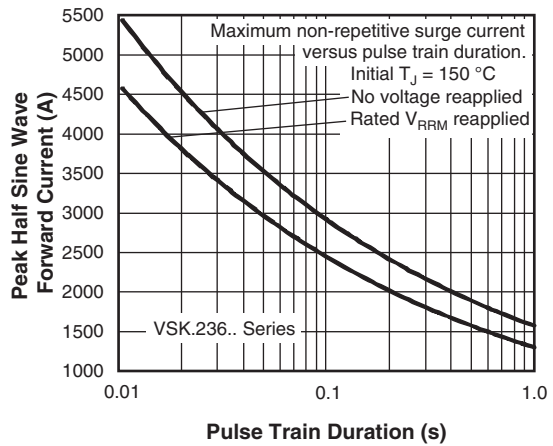

Fig. 24 - Maximum Non-Repetitive Surge Current



Fig. 25 - On-State Power Loss Characteristics

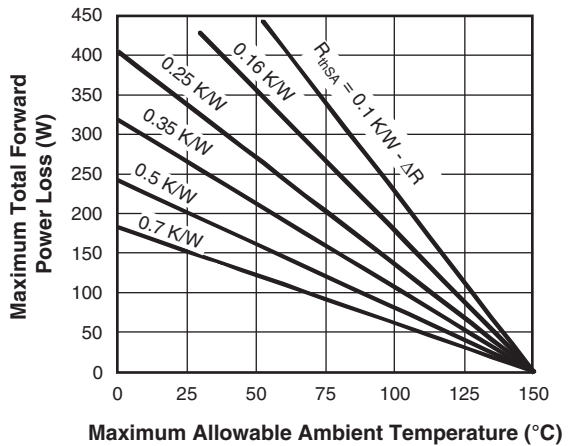

Fig. 26 - On-State Power Loss Characteristics

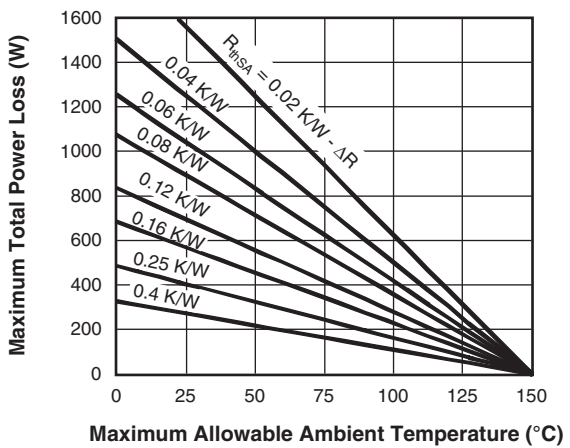



Fig. 27 - On-State Power Loss Characteristics

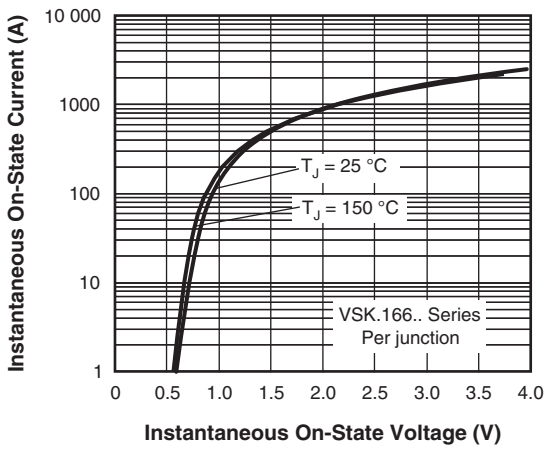

Fig. 28 - On-State Voltage Drop Characteristics

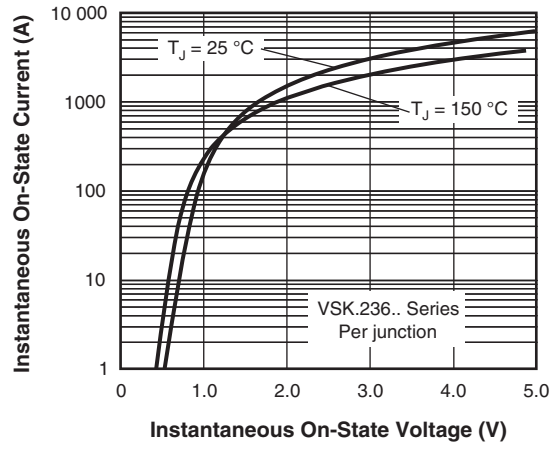

Fig. 30 - On-State Voltage Drop Characteristics

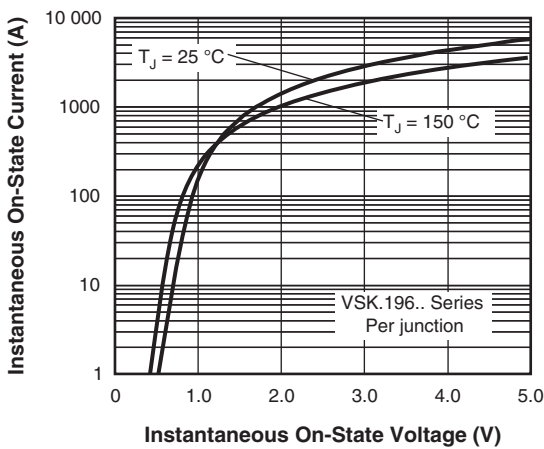

Fig. 29 - On-State Voltage Drop Characteristics

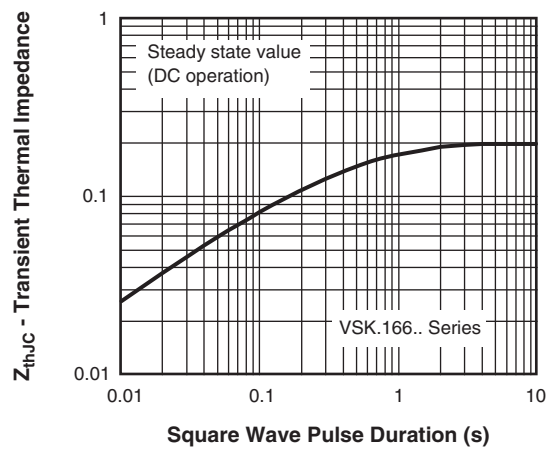

Fig. 31 - Thermal Impedance $Z_{\theta JC}$ Characteristics

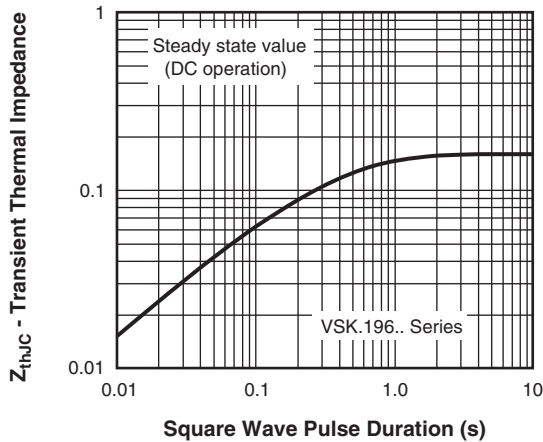

Fig. 32 - Thermal Impedance Z_{thJC} Characteristics

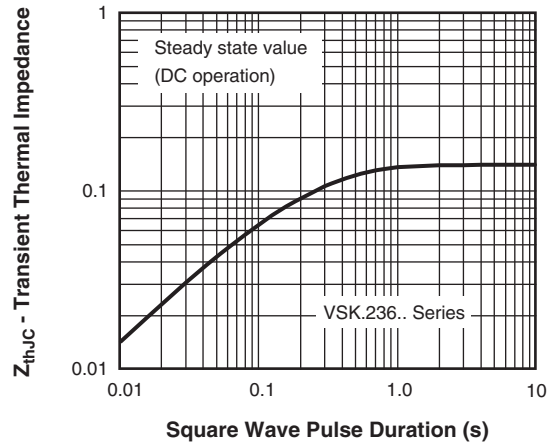

Fig. 33 - Thermal Impedance Z_{thJC} Characteristics

ORDERING INFORMATION TABLE

Device code	VS-VS	KD	236	16	PbF
	①	②	③	④	⑤
	1	-	Vishay Semiconductors product		
	2	-	Circuit configuration		
	3	-	Current rating: $I_{F(AV)}$		
	4	-	Voltage code x 100 = V_{RRM}		
	5	-	PbF = Lead (Pb)-free		

Note

- To order the optional hardware go to www.vishay.com/doc?95172



CIRCUIT CONFIGURATION		
CIRCUIT DESCRIPTION	CIRCUIT CONFIGURATION CODE	CIRCUIT DRAWING
Two diodes doubler circuit	D	<p>VSKD...</p>
Two diodes common cathodes	C	<p>VS KC...</p>
Two diodes common anodes	J	<p>VSKJ...</p>
Single diode	E	<p>VS KE...</p>

LINKS TO RELATED DOCUMENTS	
Dimensions	www.vishay.com/doc?95254

INT-A-PAK DBC

DIMENSIONS in millimeters (inches)





Disclaimer

ALL PRODUCT, PRODUCT SPECIFICATIONS AND DATA ARE SUBJECT TO CHANGE WITHOUT NOTICE TO IMPROVE RELIABILITY, FUNCTION OR DESIGN OR OTHERWISE.

Vishay Intertechnology, Inc., its affiliates, agents, and employees, and all persons acting on its or their behalf (collectively, "Vishay"), disclaim any and all liability for any errors, inaccuracies or incompleteness contained in any datasheet or in any other disclosure relating to any product.

Vishay makes no warranty, representation or guarantee regarding the suitability of the products for any particular purpose or the continuing production of any product. To the maximum extent permitted by applicable law, Vishay disclaims (i) any and all liability arising out of the application or use of any product, (ii) any and all liability, including without limitation special, consequential or incidental damages, and (iii) any and all implied warranties, including warranties of fitness for particular purpose, non-infringement and merchantability.

Statements regarding the suitability of products for certain types of applications are based on Vishay's knowledge of typical requirements that are often placed on Vishay products in generic applications. Such statements are not binding statements about the suitability of products for a particular application. It is the customer's responsibility to validate that a particular product with the properties described in the product specification is suitable for use in a particular application. Parameters provided in datasheets and/or specifications may vary in different applications and performance may vary over time. All operating parameters, including typical parameters, must be validated for each customer application by the customer's technical experts. Product specifications do not expand or otherwise modify Vishay's terms and conditions of purchase, including but not limited to the warranty expressed therein.

Except as expressly indicated in writing, Vishay products are not designed for use in medical, life-saving, or life-sustaining applications or for any other application in which the failure of the Vishay product could result in personal injury or death. Customers using or selling Vishay products not expressly indicated for use in such applications do so at their own risk. Please contact authorized Vishay personnel to obtain written terms and conditions regarding products designed for such applications.

No license, express or implied, by estoppel or otherwise, to any intellectual property rights is granted by this document or by any conduct of Vishay. Product names and markings noted herein may be trademarks of their respective owners.

Material Category Policy

Vishay Intertechnology, Inc. hereby certifies that all its products that are identified as RoHS-Compliant fulfill the definitions and restrictions defined under Directive 2011/65/EU of The European Parliament and of the Council of June 8, 2011 on the restriction of the use of certain hazardous substances in electrical and electronic equipment (EEE) - recast, unless otherwise specified as non-compliant.

Please note that some Vishay documentation may still make reference to RoHS Directive 2002/95/EC. We confirm that all the products identified as being compliant to Directive 2002/95/EC conform to Directive 2011/65/EU.

Vishay Intertechnology, Inc. hereby certifies that all its products that are identified as Halogen-Free follow Halogen-Free requirements as per JEDEC JS709A standards. Please note that some Vishay documentation may still make reference to the IEC 61249-2-21 definition. We confirm that all the products identified as being compliant to IEC 61249-2-21 conform to JEDEC JS709A standards.



Компания «ЭлектроПласт» предлагает заключение долгосрочных отношений при поставках импортных электронных компонентов на взаимовыгодных условиях!

Наши преимущества:

- Оперативные поставки широкого спектра электронных компонентов отечественного и импортного производства напрямую от производителей и с крупнейших мировых складов;
- Поставка более 17-ти миллионов наименований электронных компонентов;
- Поставка сложных, дефицитных, либо снятых с производства позиций;
- Оперативные сроки поставки под заказ (от 5 рабочих дней);
- Экспресс доставка в любую точку России;
- Техническая поддержка проекта, помощь в подборе аналогов, поставка прототипов;
- Система менеджмента качества сертифицирована по Международному стандарту ISO 9001;
- Лицензия ФСБ на осуществление работ с использованием сведений, составляющих государственную тайну;
- Поставка специализированных компонентов (Xilinx, Altera, Analog Devices, Intersil, Interpoint, Microsemi, Aeroflex, Peregrine, Syfer, Eurofarad, Texas Instrument, Miteq, Cobham, E2V, MA-COM, Hittite, Mini-Circuits, General Dynamics и др.);

Помимо этого, одним из направлений компании «ЭлектроПласт» является направление «Источники питания». Мы предлагаем Вам помощь Конструкторского отдела:

- Подбор оптимального решения, техническое обоснование при выборе компонента;
- Подбор аналогов;
- Консультации по применению компонента;
- Поставка образцов и прототипов;
- Техническая поддержка проекта;
- Защита от снятия компонента с производства.



Как с нами связаться

Телефон: 8 (812) 309 58 32 (многоканальный)

Факс: 8 (812) 320-02-42

Электронная почта: org@eplast1.ru

Адрес: 198099, г. Санкт-Петербург, ул. Калинина, дом 2, корпус 4, литера А.