



14 Gbps, 2 x 2 CROSSPOINT SWITCH WITH PROGRAMMABLE OUTPUT VOLTAGE

Typical Applications

The HMC857LC5 is ideal for:

- SONET OC-192 and 10 GbE
- 16G Fiber Channel
- Networking & Storage
- Dual 2:1 Selector
- 1:2 Fanout with Input Mux

Features

- Supports High Data Rates: up to 14 Gbps
- Differential or Single-Ended Inputs / Outputs
- Fast Rise and Fall Times: 21 / 21 ps
- Low Power Consumption: 345 mW typ.
- Programmable Differential Output Voltage Swing: 475 - 1200 mVp-p
- Propagation Delay: 117 ps
- Single Supply: -3.3 V
- 32 Lead Ceramic 5 x 5 mm SMT Package: 25 mm²

Functional Diagram

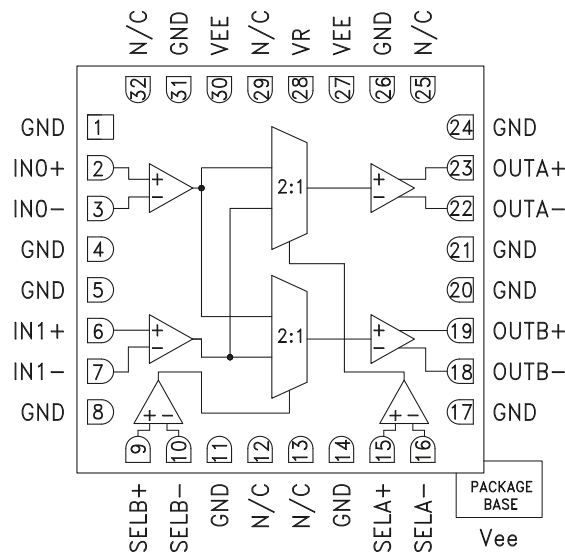

General Description

The HMC857LC5 is a 2x2 Crosspoint Switch designed to support data transmission rates of up to 14 Gbps and selector port operation up to 14 GHz. The selector routes the differential inputs to either one or both of the desired outputs upon assertion of the appropriately selected port.

All differential inputs to the HMC857LC5 are CML and terminated on-chip with 50 Ohms to the positive supply, GND, and may be DC or AC coupled. Outputs can be connected directly to a 50 Ohm ground-terminated system or drive devices with CML logic input. The HMC857LC5 also features an output level control pin, VR, which allows for loss compensation or signal level optimization. The HMC857LC5 operates from a single -3.3 V supply and is available in ROHS-compliant 3x3 mm SMT package.

Electrical Specifications, $T_A = +25^\circ\text{C}$, $V_{ee} = -3.3\text{ V}$, $V_r = 0\text{ V}$

Parameter	Conditions	Min.	Typ.	Max	Units
Power Supply Voltage		-3.6	-3.3	-3.0	V
Power Supply Current			105		mA
Maximum Data Rate			14		Gbps
Maximum Select Rate			14		GHz
Input Voltage Range		-1.5		0.5	V
Input Differential Range		0.1		2.0	Vp-p
Input Return Loss	Frequency <20 GHz		10		dB
Output Amplitude	Single-Ended, peak-to-peak		500		mVp-p
	Differential, peak-to-peak		1000		mVp-p
Output High Voltage			-10		mV
Output Low Voltage			-510		mV



**14 Gbps, 2 x 2 CROSSPOINT SWITCH
 WITH PROGRAMMABLE OUTPUT VOLTAGE**

Electrical Specifications (continued)

Parameter	Conditions	Min.	Typ.	Max.	Units
Output Rise / Fall Time	Differential, 20% - 80%		21		ps
Output Return Loss	Frequency <22 GHz		10		dB
Random Jitter, Jr	rms [1]		0.08	0.11	ps rms
Deterministic Jitter, Jd	peak-to-peak, 2 ¹⁵ -1 PRBS input [1]		2		ps, p-p
Propagation Delay, A or B to D _{OUT} , t _d			117		ps
Propagation Delay Select to Data, t _{sd}			114		ps
Set Up & Hold Time, t _{SH}			5		ps

[1] Added jitter calculated by de-embedding the source's jitter at 13 Gbps, 2¹⁵-1 PRBS input.

DC Current vs. Supply Voltage [1][2]

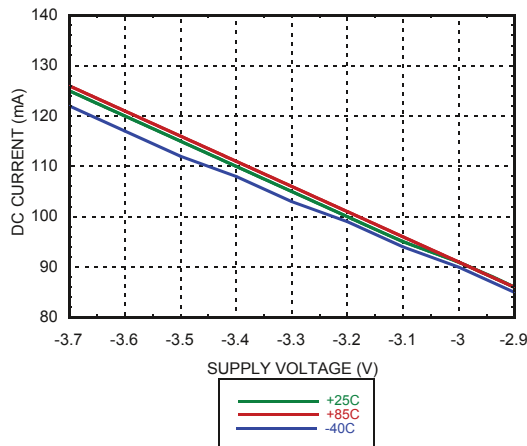

DC Current vs. VR [2][3]

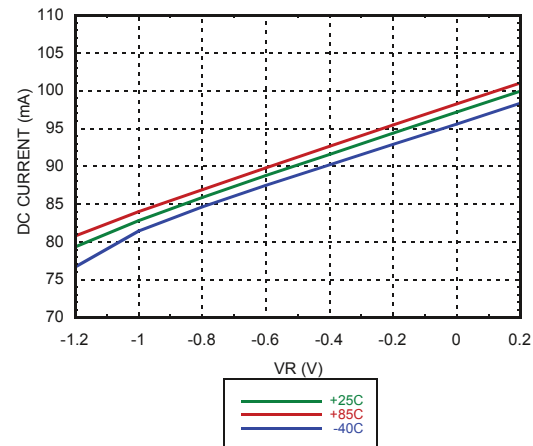

Output Differential Voltage vs. Supply Voltage [1][2]

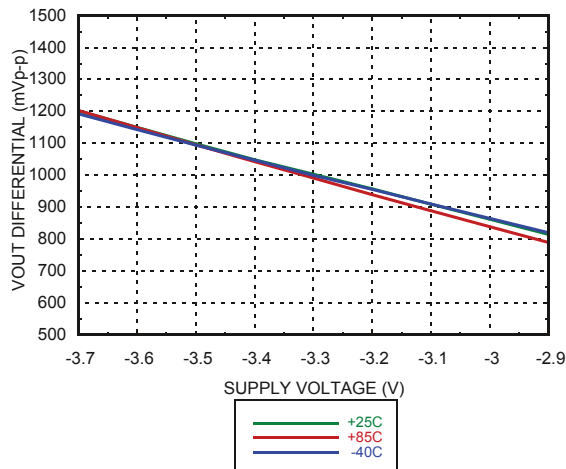

Output Differential Voltage vs. VR [2][3]

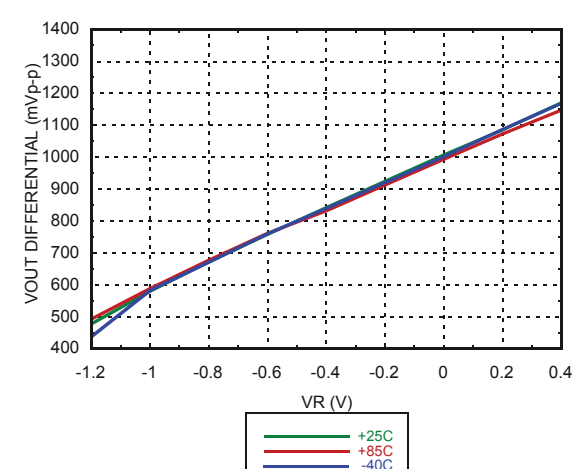

[1] VR = 0.0 V

[2] Frequency = 13 GHz

[3] Vee = -3.3 V



**14 Gbps, 2 x 2 CROSSPOINT SWITCH
 WITH PROGRAMMABLE OUTPUT VOLTAGE**

Rise / Fall Time vs. Supply Voltage [1] [2]

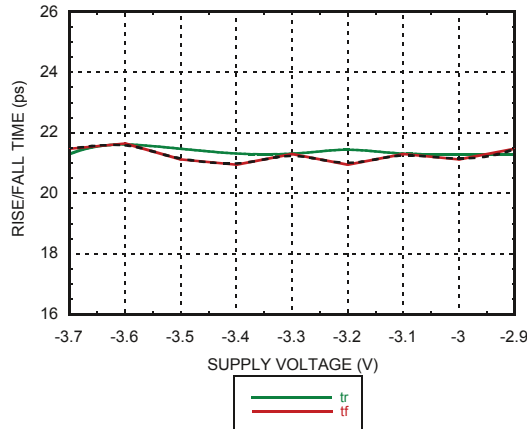

Rise / Fall Time vs. VR [2] [3]

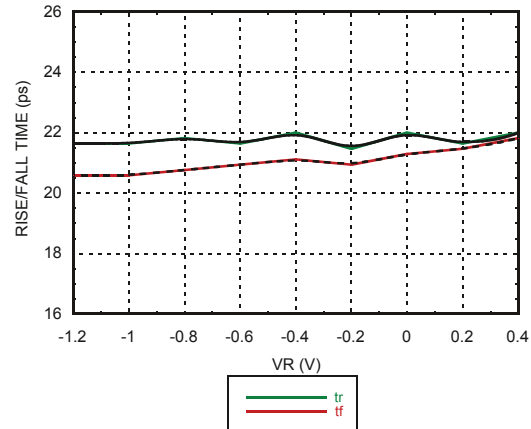

Select Input Return Loss vs. Frequency [1] [3] [4]

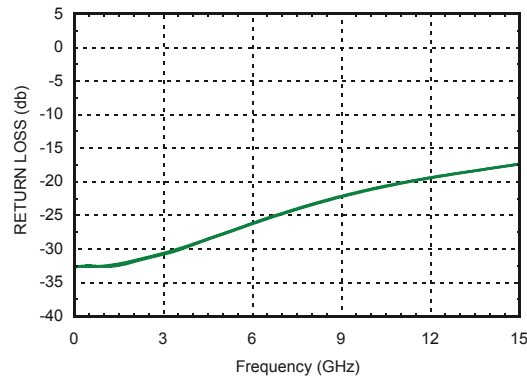

Data Input Return Loss vs. Frequency [1] [3] [4]

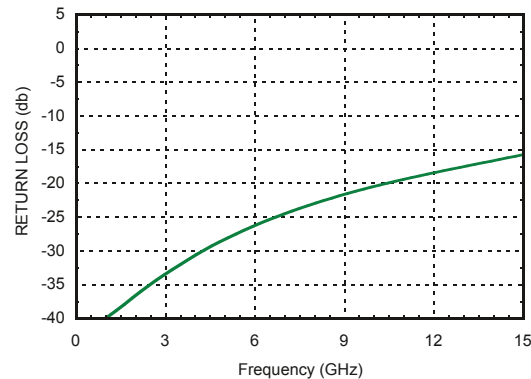

Output Return Loss vs. Frequency [1] [3] [4]

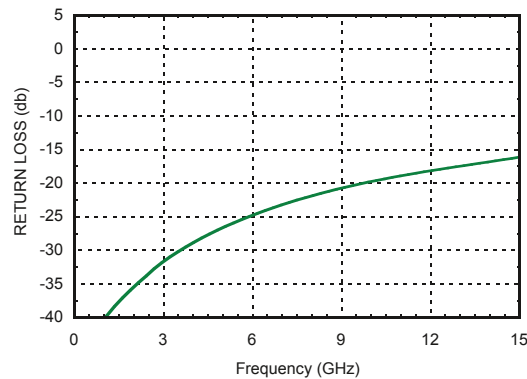

Response vs. Input Power [1] [3] [5]

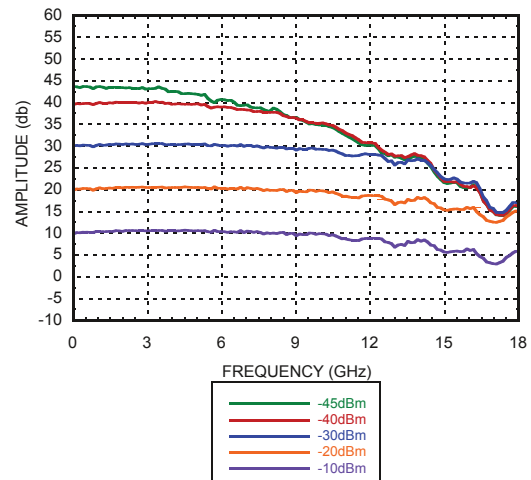

[1] VR = 0.0 V

[2] Frequency = 13 GHz

[3] Vee = -3.3 V

[4] Device measured on evaluation board with gating

[5] Device measured on evaluation board with port extensions

**14 Gbps, 2 x 2 CROSSPOINT SWITCH
 WITH PROGRAMMABLE OUTPUT VOLTAGE**

Isolation [1] [2] [3]

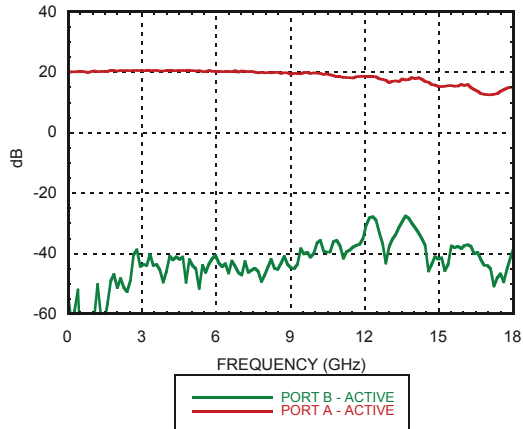

Eye Diagram

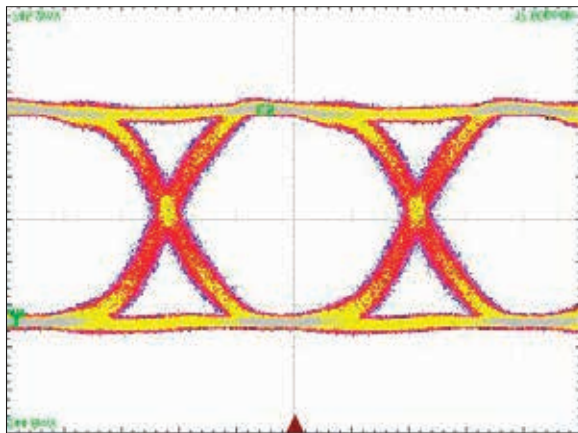

[1] Test Conditions:
 Waveform generated with a differential 400 mV Agilent N4903A J-Bert with a 13 Gbps PN 2¹⁵ -1 signal.
 Eye Diagram data presented on a Tektronix CSA 8000

Timing Diagram

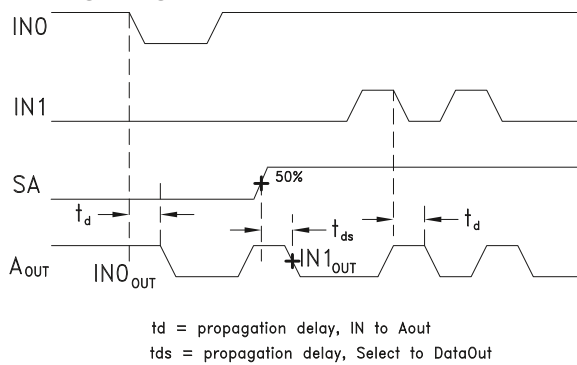

Truth Table

Inputs		Outputs
SB	SA	DP
X	L	IN0 ->A
X	H	IN1 ->A
L	X	IN0 ->B
H	X	IN1 -> B

H = Positive voltage level
 L = Negative voltage level

Notes:
 D = DP - DN
 IN0 = IN0P - IN0N
 IN1 = IN1P - IN1N

[1] VR = 0.0 V [2] Device measured on evaluation board with port extensions [3] Vee = -3.3 V

**14 Gbps, 2 x 2 CROSSPOINT SWITCH
WITH PROGRAMMABLE OUTPUT VOLTAGE**

Absolute Maximum Ratings

Power Supply Voltage (Vee)	-3.75 V to +0.5 V
Input Signals	-2.0 V to 0.5 V
Output Signals	-1.5 V to 0.5 V
Junction Temperature	125 °C
Continuous Pdiss (T = 85 °C (derate 33.0 mW/°C above 85 °C))	1.33 W
Thermal Resistance (R _{th-jp}) Worst case device to package paddle	30 °C/W
Storage Temperature	-65 °C to +150 °C
Operating Temperature	-40 °C to +85 °C
ESD Sensitivity (HBM)	Class 1B



**ELECTROSTATIC SENSITIVE DEVICE
OBSERVE HANDLING PRECAUTIONS**

Outline Drawing

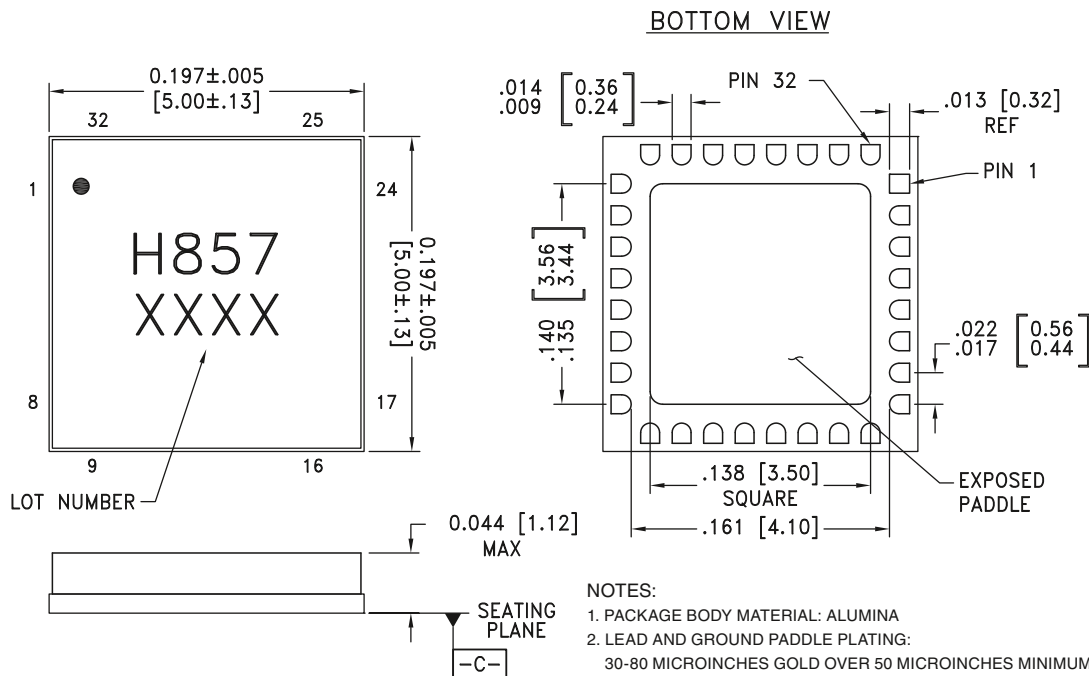

- NOTES:
1. PACKAGE BODY MATERIAL: ALUMINA
 2. LEAD AND GROUND PADDLE PLATING:
30-80 MICROINCHES GOLD OVER 50 MICROINCHES MINIMUM NICKEL.
 3. DIMENSIONS ARE IN INCHES [MILLIMETERS].
 4. LEAD SPACING TOLERANCE IS NON-CUMULATIVE.
 5. PACKAGE WARP SHALL NOT EXCEED 0.05mm DATUM -C-
 6. ALL GROUND LEADS MUST BE SOLDERED TO PCB RF GROUND.
 7. PADDLE MUST BE SOLDERED TO Vee.

Package Information

Part Number	Package Body Material	Lead Finish	MSL Rating	Package Marking ^[2]
HMC857LC5	Alumina, White	Gold over Nickel	MSL3 ^[1]	H857 XXXX

[1] Max peak reflow temperature of 260 °C

[2] 4-Digit lot number XXXX



**14 Gbps, 2 x 2 CROSSPOINT SWITCH
WITH PROGRAMMABLE OUTPUT VOLTAGE**

Pin Descriptions

Pin Number	Function	Description	Interface Schematic
1, 4, 5, 8, 11, 14, 17, 20, 21, 24	GND	Signal Grounds	
2, 3, 6, 7	In0+, In0-, In1+, In1-	Differential Inputs: Current Mode Logic (CML) referenced to positive supply.	
9, 10, 15, 16	SelB+, SelB-, SelA+, SelA-	Differential Select Inputs: Current Mode Logic (CML) referenced to positive supply.	
12, 13, 25, 29, 32	N/C	No connection necessary. These pins may be connected to RF/DC ground without affecting performance.	
18, 19, 22, 23	OutB-, OutB+, OutA-, OutA+	Differential Outputs: Current Mode Logic (CML) referenced to positive supply.	
26, 31	GND	Supply Ground	
27, 30 Package Base	Vee	These pins and the exposed paddle must be connected to the negative voltage supply.	
28	VR	Output level control. Output level may be increased or decreased by applying a voltage to VR per "Output Differential vs. VR" plot.	

**14 Gbps, 2 x 2 CROSSPOINT SWITCH
WITH PROGRAMMABLE OUTPUT VOLTAGE**

Evaluation PCB

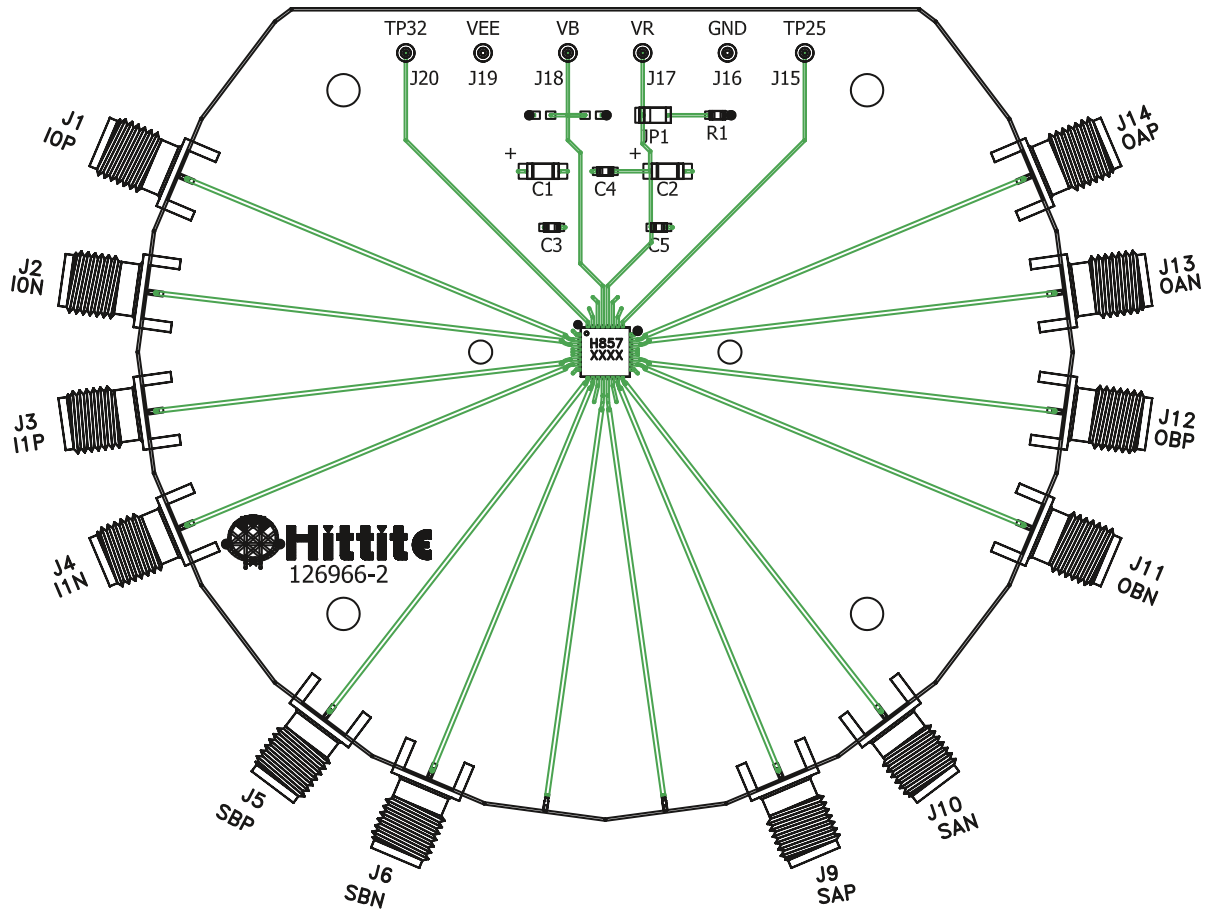

List of Materials for Evaluation PCB 126968 [1]

Item	Description
J1 - J6, J9 - J14	PCB Mount SMA RF Connectors
J15 - J20	DC Pin
JP1	0.1" Header with Shorting Jumper
C1, C2	4.7 μ F Capacitor, Tantalum
C3 - C5	330 pF Capacitor, 0402 Pkg.
R1	10 Ohm Resistor, 0603 Pkg.
U1	HMC857LC5 2 x 2 Crossbar Switch
PCB [2]	126966 Evaluation Board

[1] Reference this number when ordering complete evaluation PCB

[2] Circuit Board Material: Arlon 25FR or Rogers 4350

The circuit board used in the application should use RF circuit design techniques. Signal lines should have 50 Ohm impedance while the package ground leads should be connected directly to the ground plane similar to that shown. The exposed package base should be connected to Vee. A sufficient number of via holes should be used to connect the top and bottom ground planes. The evaluation circuit board shown is available from Hittite upon request. Install jumper on JP1 to short VR to GND for normal operation.

**14 Gbps, 2 x 2 CROSSPOINT SWITCH
 WITH PROGRAMMABLE OUTPUT VOLTAGE**

Application Circuit

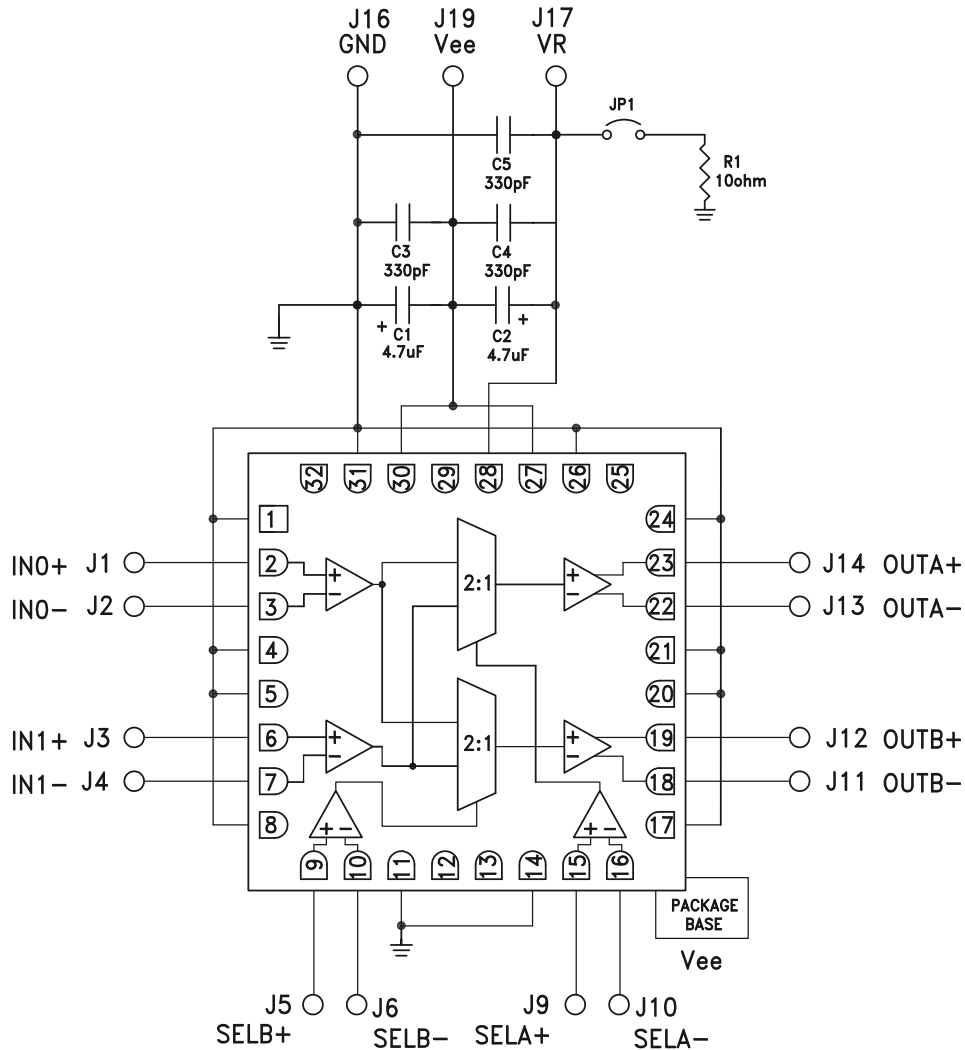



Компания «ЭлектроПласт» предлагает заключение долгосрочных отношений при поставках импортных электронных компонентов на взаимовыгодных условиях!

Наши преимущества:

- Оперативные поставки широкого спектра электронных компонентов отечественного и импортного производства напрямую от производителей и с крупнейших мировых складов;
- Поставка более 17-ти миллионов наименований электронных компонентов;
- Поставка сложных, дефицитных, либо снятых с производства позиций;
- Оперативные сроки поставки под заказ (от 5 рабочих дней);
- Экспресс доставка в любую точку России;
- Техническая поддержка проекта, помощь в подборе аналогов, поставка прототипов;
- Система менеджмента качества сертифицирована по Международному стандарту ISO 9001;
- Лицензия ФСБ на осуществление работ с использованием сведений, составляющих государственную тайну;
- Поставка специализированных компонентов (Xilinx, Altera, Analog Devices, Intersil, Interpoint, Microsemi, Aeroflex, Peregrine, Syfer, Eurofarad, Texas Instrument, Miteq, Cobham, E2V, MA-COM, Hittite, Mini-Circuits, General Dynamics и др.);

Помимо этого, одним из направлений компании «ЭлектроПласт» является направление «Источники питания». Мы предлагаем Вам помощь Конструкторского отдела:

- Подбор оптимального решения, техническое обоснование при выборе компонента;
- Подбор аналогов;
- Консультации по применению компонента;
- Поставка образцов и прототипов;
- Техническая поддержка проекта;
- Защита от снятия компонента с производства.



Как с нами связаться

Телефон: 8 (812) 309 58 32 (многоканальный)

Факс: 8 (812) 320-02-42

Электронная почта: org@eplast1.ru

Адрес: 198099, г. Санкт-Петербург, ул. Калинина, дом 2, корпус 4, литера А.