

HIGH EFFICIENCY, SMALL PACKAGES, STEP-UP DC/DC CONVERTERS

NO.EA-193-150909

OUTLINE

RP400xxx1A Series are high efficiency, step-up DC/DC converter ICs packaged in compact 5pin SOT23 or 6pin DFN(PLP). This converter starts up of low voltage (Typ.0.8V) operation from one to two alkaline or a nickel-metal-hydride (NiMH) or one-cell Lithium-ion (Li+) battery.

This IC consists of a reference voltage unit with soft start, a chip enable circuit, an error amplifier, phase compensation circuits, a slope circuit, a PWM control circuit, a start-up circuit, a PWM/VFM mode control circuit, internal switches and a protection circuit. As a protection circuit, RP400xxx1A has a current limit circuit which limits the peak current of the inductor at each clock cycle.

A low ripple high efficiency step up DC/DC converter can be composed of RP400xxx1A Series with only an inductor, a diode and capacitors. This converter is based on a fixed frequency current mode PWM control which goes to power save mode (VFM mode) at light load automatically. RP400xxx1A Series has built-in Anti-ringing switch to prevent switching node from ringing, when the converter enters the discontinuous current mode.

The output voltage of RP400K001A can be set within 1.8~5.0V (recommended range of output voltage) by external divider resistors.

FEATURES

- Low Start-up Voltage guaranteed0.8V
- Input Voltage Range0.8V ~ 5.5V
- High Efficiency85% (100mA / 3.3V, $V_{IN} = 1.5V$, 25°C)
- Output current200mA / 3.3V ($V_{IN} = 1.5V$) Typ.100mA / 2.0V ($V_{IN} = 1.2V$)
- Internal Switch.....NMOS = 0.4Ω ($V_{OUT} = 3.3V$, 25°C)
- Built-in Phase Compensation, Soft Start, Peak Current Limit Protection
- PWM Oscillator Frequency.....700kHz
- Output Voltage Range.....Fixed: 1.8V to 5.0V with 0.1V Stepwise
Adjustable: 1.8V ~ 5.0V (RP400K001A only)
(Recommended range of output voltage)
- Stable with Ceramic Capacitors
- Small PackageDFN(PLP)1820-6, SOT23-5
- Internal EMI suppression (Anti-ringing switch is included)

APPLICATIONS

- MP3 players, PDA
- Digital Still Cameras
- LCD Bias Supplies
- Portable blood pressure meter
- Wireless Handset
- GPS

SELECTION GUIDE

In the RP400 Series, output Voltage, Type of Output Voltage, and package for the ICs can be selected at the user's request.

Product Name	Package	Quantity per Reel	Pb Free	Halogen Free
RP400Kxx1A-TR	DFN (PLP)1820-6	5,000 pcs	Yes	Yes
RP400Nxx1A-TR-FE	SOT-23-5	3,000 pcs	Yes	Yes

xx : Designation of output voltage
 00: Adjustable Version (1.8V ~ 5.0V) * recommended range of output voltage / DFN(PLP)1820-6 only
 Fixed version is possible in the range from 1.8V to 5.0V with a step of 0.1V

PIN CONFIGURATION

DFN(PLP)1820-6

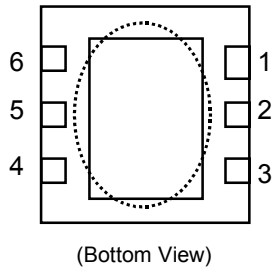

SOT-23-5

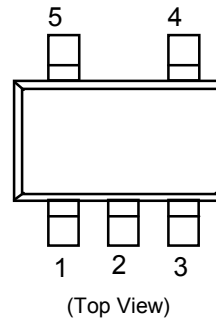

PIN DESCRIPTION

RP400K001A: DFN(PLP)1820-6

Pin No	Symbol	Pin Description
1	V_{IN}	Power Supply Pin
2	CE	Chip Enable Pin (Active with "H")
3	GND	Ground Pin
4	Lx	Internal NMOS Switch Drain Pin
5	V_{FB}	Feedback Input Pin for setting output voltage
6	V_{OUT}	Output Pin

* Tab is GND level. (They are connected to the reverse side of this IC.) The tab is better to be connected to the GND, but leaving it open is also acceptable.

RP400Kxx1A: DFN(PLP)1820-6

Pin No	Symbol	Pin Description
1	V_{IN}	Power Supply Pin
2	CE	Chip Enable Pin (Active with "H")
3	GND	Ground Pin
4	Lx	Internal NMOS Switch Drain Pin
5	NC	No Connection
6	V_{OUT}	Output Pin

* Tab is GND level. (They are connected to the reverse side of this IC.) The tab is better to be connected to the GND, but leaving it open is also acceptable.

RP400Nxx1A: SOT-23-5

Pin No	Symbol	Pin Description
1	CE	Chip Enable Pin (Active with "H")
2	GND	Ground Pin
3	V_{IN}	Power Supply Pin
4	V_{OUT}	Output Pin
5	Lx	Internal NMOS Switch Drain Pin

ABSOLUTE MAXIMAM RATINGS

(GND=0V)

Symbol	Items	Ratings		Unit
V _{IN}	V _{IN} Supply Voltage	-0.3 to 6.0		V
V _{OUT}	V _{OUT} Pin Voltage	-0.3 to 6.0		V
V _{LX}	Lx Pin Input Voltage	-0.3 to 6.0		V
V _{CE}	CE Pin Voltage	-0.3 to 6.0		V
V _{FB}	V _{FB} Pin Voltage	RP400K001A	-0.3 to 6.0	V
I _{LX}	Lx Pin Output Current	0.8		A
P _D	Power Dissipation *	SOT-23-5	420	mW
		DFN(PLP)1820-6	880	
T _a	Ambient Temp Range	-40 to +85		°C
T _{stg}	Storage Temp Range	-55 to +125		°C

*) For Power Dissipation, please refer to PACKAGE INFORMATION to be described.

ABSOLUTE MAXIMUM RATINGS

Electronic and mechanical stress momentarily exceeded absolute maximum ratings may cause the permanent damages and may degrade the life time and safety for both device and system using the device in the field. The functional operation at or over these absolute maximum ratings is not assured.

RECOMMENDED OPERATING CONDITIONS (ELECTRICAL CHARACTERISTICS)

All of electronic equipment should be designed that the mounted semiconductor devices operate within the recommended operating conditions. The semiconductor devices cannot operate normally over the recommended operating conditions, even if when they are used over such conditions by momentary electronic noise or surge. And the semiconductor devices may receive serious damage when they continue to operate over the recommended operating conditions.

ELECTRICAL CHARACTERISTICS

(Ta=25°C)

Symbol	Item	Conditions		MIN.	TYP.	MAX.	Unit
V _{IN}	Input Voltage					5.5	V
V _{start2}	Start-up Voltage 2	Load current =1mA V _{CE} =1.5V			0.7	0.9	V
V _{start3}	Start-up Voltage 3	Load current =1mA CE is connected with V _{OUT}			0.8	1.1	V
V _{hold1}	Hold-on Voltage 1 (Once started)	Load current=1mA		0.7			V
I _{DD1}	Quiescent Current 1	Adjustable Version	V _{IN} =3V V _{OUT} =5V V _{FB} =0V		500	800	μA
		Fixed Version.	V _{IN} =0.5×V _{OUT} V _{OUT} =0.95×V _{OUT}		V _{OUT} ×100	(*3)	μA
I _{DD2}	Quiescent Current 2 (No switching)	Adjustable Version	V _{IN} =V _{OUT} =5V V _{FB} =1.0V		160	300	μA
		Fixed Version	V _{IN} =V _{OUT} =5V		160	300	μA
I _{standby}	Standby Current	V _{IN} =V _{OUT} =5V V _{CE} =0V			0.15	3	μA
V _{FB}	Feedback Voltage (Adjustable Version)	V _{IN} =V _{OUT} =3.3V		0.588	0.600	0.612	V
V _{OUT}	Output-Voltage (Fixed Version)	V _{IN} =V _{CE} =1.5V		×0.98		×1.02	V
ΔV _{OUT} /ΔTa	Output-Voltage Temperature Coefficient	-40°C≤Ta≤85°C			±100		ppm /°C
F _{osc}	Switching Frequency	Adjustable Version	V _{IN} =V _{OUT} =3.3V	595	700	805	kHz
		Fixed Version.	V _{IN} =V _{OUT} =0.95×V _{OUT}	595	700	805	kHz
Δf _{osc} /ΔTa	Switching Frequency Temperature Coefficient	-40°C≤Ta≤85°C			±0.2		kHz /°C
R _{ONN}	NMOS On-Resistance (*1)	V _{OUT} =3.3V			0.4		Ω
I _{CEH}	CE "H" Input Current	V _{IN} =V _{OUT} =V _{CE} =5V				0.5	μA
I _{CEL}	CE "L" Input Current	V _{IN} =V _{OUT} =5V V _{CE} =0V		-0.5			μA
I _{FBH}	FB "H" Input Current (Adjustable Version)	V _{IN} =V _{OUT} =V _{FB} =5V				0.5	μA
I _{XFBL}	FB "L" Input Current (Adjustable Version)	V _{IN} =V _{OUT} =5V V _{FB} =0V		-0.5			μA
I _{LX}	Lx Leak Current	V _{IN} =V _{OUT} =V _{LX} =5V V _{CE} =0V				5	μA
I _{Lxpeak}	Lx Leak Current limit (*2)	Adjustable Version	V _{OUT} =3.3V Detective at Duty=MaxDuty-5%	0.4	0.6		A
		Fixed Version.	V _{OUT} =0.95×V _{OUT} Detective at Duty=MaxDuty-5%	0.4	0.6		A

ELECTRICAL CHARACTERISTICS (cont.)

(Ta=25°C)

Symbol	Item	Conditions		MIN.	TYP.	MAX.	Unit
V _{CEH}	CE Input "H" level Voltage	Adjustable Version	V _{OUT} =3.3V	0.9			V
		Fixed Version.	V _{IN} =V _{OUT} =0.95×V _{OUT}	0.9			V
V _{CEL}	CE Input "L" level Voltage	Adjustable Version	V _{IN} =V _{OUT} =3.3V			0.4	V
		Fixed Version.	V _{IN} =V _{OUT} =0.95×V _{OUT}			0.4	V
Maxduty	Max Duty	Adjustable Version	V _{IN} =V _{OUT} =3.3V V _{FB} =0V	80	88	95	%
		Fixed Version.	V _{IN} =V _{OUT} =0.95×V _{OUT}	80	88	95	%
t _{start}	Soft Start period	Adjustable Version	V _{IN} =1.65V V _{OUT} =3.3V V _{CE} =0V to 1.5V At V _{OUT} =2.97V	0.08	0.7	3.0	ms
		Fixed Version.	V _{IN} =V _{OUT} ×0.5 V _{CE} =0V to 1.5V At V _{OUT} =V _{OUT} ×0.9	0.08	0.7	3.0	ms
R _{ONA}	Anti-ringing switch On Resistance	Adjustable Version	V _{IN} =V _{OUT} =3.3V		110		Ω
		Fixed Version.	V _{IN} =V _{OUT} =1.05×V _{OUT}		110		Ω

*1) Guaranteed by design engineering. NMOS On-Resistance according to the V_{OUT} voltage.

*2) Lx limit current changes by Duty.

*3) The maximum value of Operating Current 1(Fixed Version) is shown on the table below.

V _{OUT} (V)	MAX (μA)
1.8 V	290
1.9 V	310
2.0 V	320
2.1 V	340
2.2 V	360
2.3 V	370
2.4 V	390
2.5 V	400
2.6 V	420
2.7 V	440
2.8 V	450
2.9 V	470
3.0 V	480
3.1 V	500
3.2 V	520
3.3 V	530
3.4 V	550

V _{OUT} (V)	MAX (μA)
3.5 V	560
3.6 V	580
3.7 V	600
3.8 V	610
3.9 V	630
4.0 V	640
4.1 V	660
4.2 V	680
4.3 V	690
4.4 V	710
4.5 V	720
4.6 V	740
4.7 V	760
4.8 V	770
4.9 V	790
5.0 V	800

APPLICATION NOTES

Adjustable Output Voltage Type (Version:A)

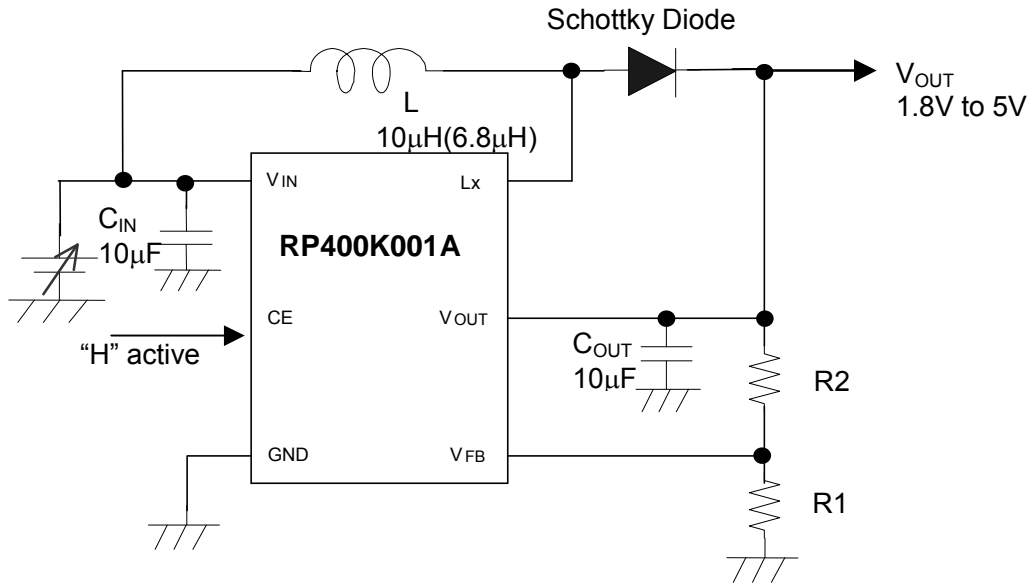

Fixed Output Voltage Type (Version:A)

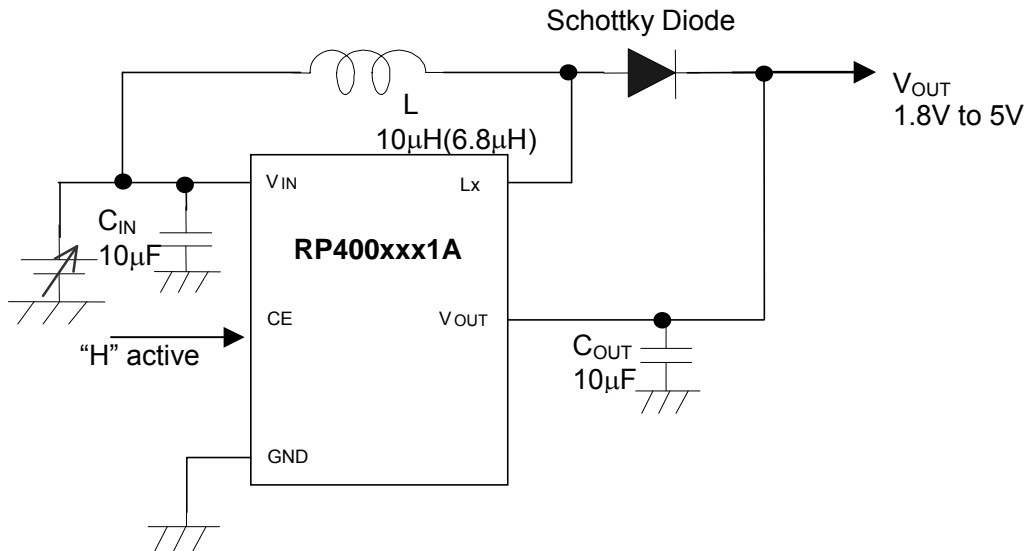

External components

- Capacitor : C2012JB1C106M (TDK)
- Diode : CRS10I30A (TOSHIBA)
- Inductor : TDK SLF7045T-100M1R3-PF (TDK)

● Setting of Output Voltage

Output voltage (1.8V to 5.0V recommended range of voltage) can be set with divider resistors for voltage setting, R1 and R2 as shown in the typical application. Refer to the next formula.

$$\text{Output Voltage} = V_{FB} \times (R1 + R2) / R1 \quad (V_{FB} = 0.6V)$$

Recommended value of resistors (R1 + R2) is lower than 100kΩ.

Make sufficient power supply and ground and reinforce supplying. The large switching current could flow through the connection of power supply, inductor, ground, diode and the connection of V_{OUT}. If the impedance of the connection of power supply and ground is high, the voltage level of power supply of the IC fluctuates with the switching current. We recommend you to use output capacitor and diode with an allowable voltage at least 1.5 times as much as setting output voltage. This is because there may be case where a spike-shaped high voltage is generated by an inductor when built-in transistor is on and off.

Use a diode of a Schottky type with high switching speed, low reverse current and also pay attention to its current capacity.

Set external components as close as possible to the IC and minimize the connection between the components and the IC. In particular, output capacitor should be connected to V_{OUT} pin with IC ground by the minimum connection, because this IC uses the V_{OUT} voltage as the main power supply, after start-up. Use capacitors with a capacity of 10μF or more for V_{OUT} pin. We recommend you to set a ceramic capacitor (10μF) between V_{IN} and ground.

The divider resistors should be placed as close as possible to the IC ground pin. V_{FB} line is recommended to use short line as well to avoid the influence of noise.

At the standby mode, the V_{OUT} and V_{IN} will be connected by the internal parasitic diode. Due to this, please do not force to impress the voltage into the V_{OUT} pin externally at standby mode, which is larger than the V_{IN} voltage.

Please select the inductor value 10μH in the case of V_{OUT} ≥ 2.5V and 6.8μH in the case of V_{OUT} < 2.5V. Choose an inductor that has sufficiently small D.C. resistance and large allowable current and is hard to reach magnetic saturation. And if the value of inductance of an inductor is extremely small, the I_{LX} may exceed the absolute maximum rating at the maximum loading. Use an inductor with appropriate inductance. (Refer to next Output Current of Step-up Circuit and External Components)

*The performance of power circuit using those ICs extremely depends upon the peripheral circuits. Pay attention in the selection of the peripheral circuits. In particular, design the peripheral circuits in a way that the values such as voltage, current, and power of each component, PCB patterns and the IC do not exceed their respected rated values. (such as the voltage, current, and power)

OUTPUT CURRENT OF STEP-UP CIRCUIT AND EXTERNAL COMPONENTS

<Basic Circuit>

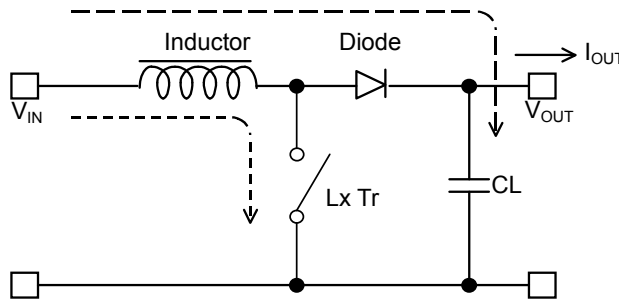

<Current through L>

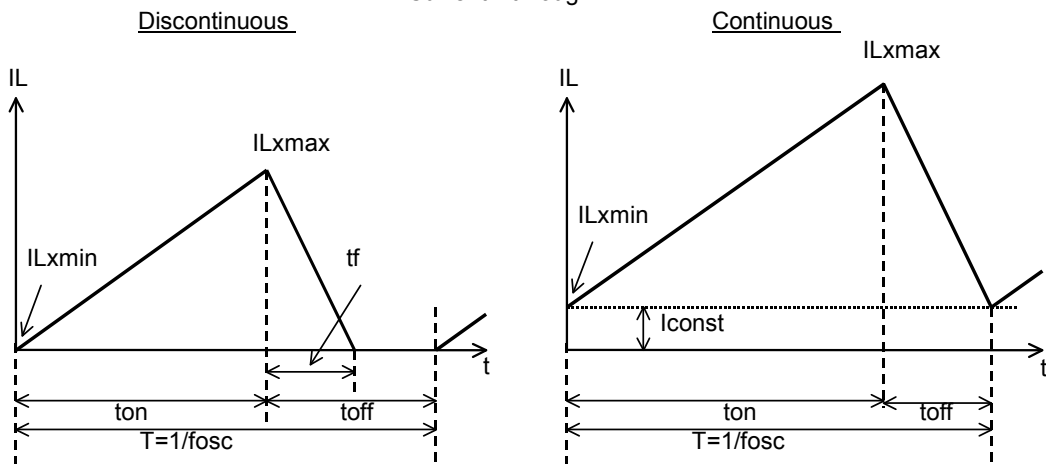

There are two modes, or discontinuous mode and continuous mode for the PWM step-up switching regulator depending on the continuous characteristic of inductor current. During on time of the transistor, when the voltage added on to the inductor is described as V_{IN} , the current is $V_{IN} \times t / L$.

Therefore, the electric power, P_{ON} , which is supplied with input side, can be described as in next formula.

$$P_{ON} = \int_0^{ton} V_{IN}^2 \times t/L dt \dots\dots\dots \text{Formula 1}$$

With the step-up circuit, electric power is supplied from power source also during off time. In this case, input current is described as $(V_{OUT} - V_{IN}) \times t / L$, therefore electric power, P_{OFF} is described as in next formula.

$$P_{OFF} = \int_0^{toff} V_{IN} \times (V_{OUT} - V_{IN})t/L dt \dots\dots\dots \text{Formula 2}$$

In this formula, t_f means the time of which the energy saved in the inductance is being emitted. Thus average electric power, P_{AV} is described as in the next formula.

$$P_{AV} = 1/(ton + toff) \times \left\{ \int_0^{ton} V_{IN}^2 \times t/L dt + \int_0^{toff} V_{IN} \times (V_{OUT} - V_{IN})t/L dt \right\} \dots\dots\dots \text{Formula 3}$$

In PWM control, when $t_f = t_{off}$ is true, the inductor current becomes continuous, then the operation of switching regulator becomes continuous mode. In the continuous mode, the deviation of the current is equal between on time and off time.

$$V_{IN} \times t_{on} / L = (V_{OUT} - V_{IN}) \times t_{off} / L \dots\dots\dots \text{Formula 4}$$

Further, the electric power, PAV is equal to output electric power, $V_{OUT} \times I_{OUT}$, thus,

$$I_{OUT} = f_{osc} \times V_{IN}^2 \times t_{on}^2 / \{2 \times L (V_{OUT} - V_{IN})\} = V_{IN}^2 \times t_{on} / (2 \times L \times V_{OUT}) \dots\dots\dots \text{Formula 5}$$

When I_{OUT} becomes more than $V_{IN} \times t_{on} \times t_{off} / (2 \times L \times (t_{on} + t_{off}))$, the current flows through the inductor, then the mode becomes continuous. The continuous current through the inductor is described as I_{const} , then,

$$I_{OUT} = f_{osc} \times V_{IN}^2 \times t_{on}^2 / (2 \times L \times (V_{OUT} - V_{IN})) + V_{IN} \times I_{const} / V_{OUT} \dots\dots\dots \text{Formula 6}$$

In this moment, the peak current, I_{lxmax} flowing through the inductor and the driver Tr. Is described as follows:

$$I_{lxmax} = I_{const} + V_{IN} \times t_{on} / L \dots\dots\dots \text{Formula 7}$$

With the formula 4, 6 and I_{lxmax} is

$$I_{lxmax} = V_{OUT} / V_{IN} \times I_{OUT} + V_{IN} \times t_{on} / (2 \times L) \dots\dots\dots \text{Formula 8}$$

However, $t_{on} = (1 - V_{IN} / V_{OUT}) / f_{osc}$

Therefore, peak current is more than I_{OUT} . Considering the value of I_{lxmax} , the condition of input and output, and external components should be selected.

In the formula 7, peak current I_{lxmax} at discontinuous mode can be calculated. Put $I_{const} = 0$ in the formula.

The explanation above is based on the ideal calculation, and the loss caused by Lx switch and external components is not included.

Please select the inductor and the diode with current peak to the standard (Formula 8).

TYPICAL CHARACTERISTICS

1) Output Voltage vs. Output Current

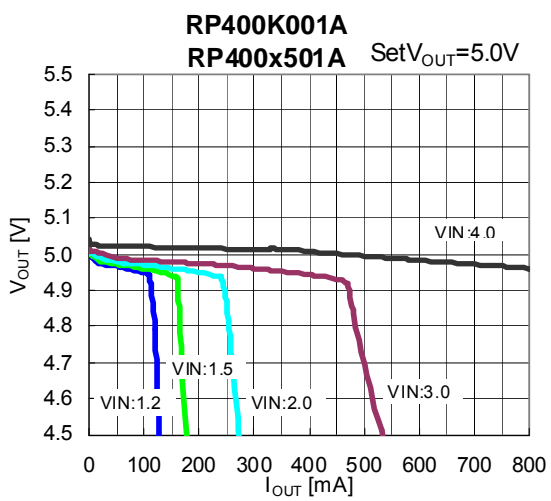
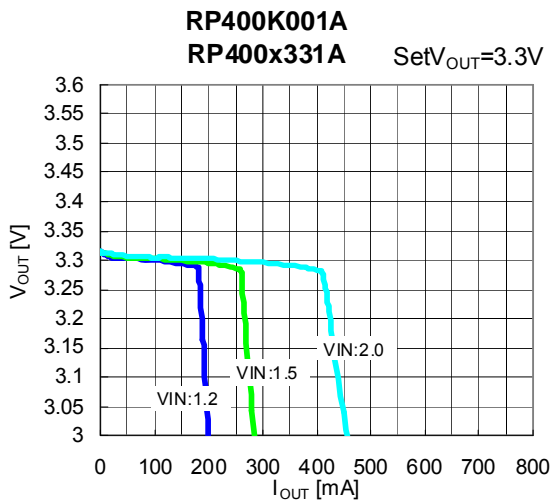
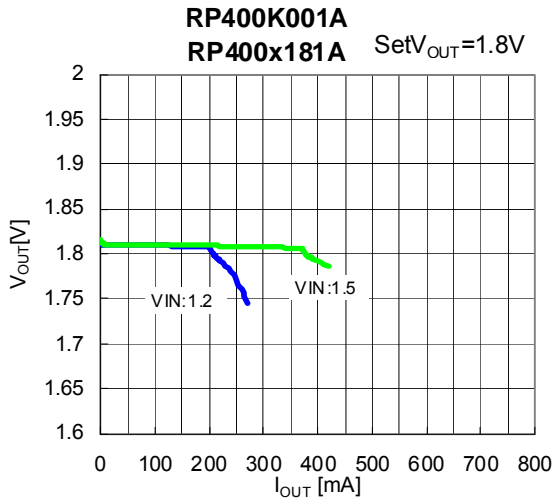

2) Efficiency vs. Output Current

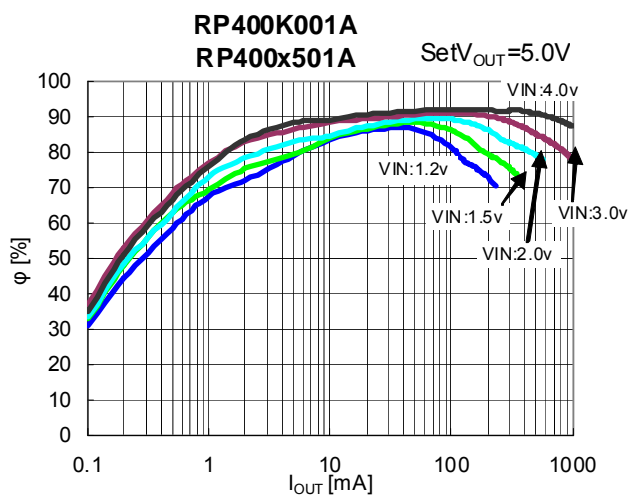
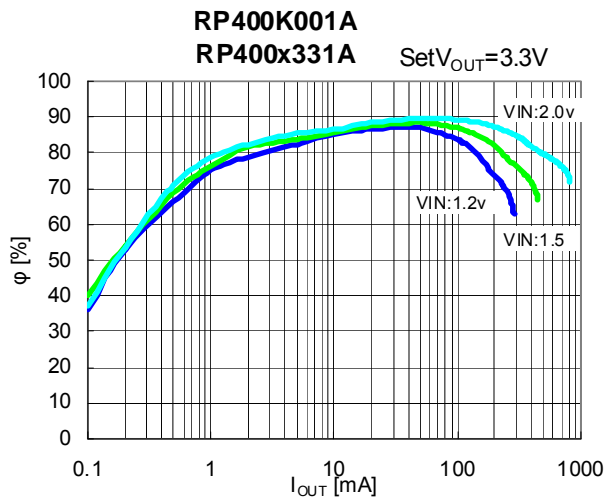
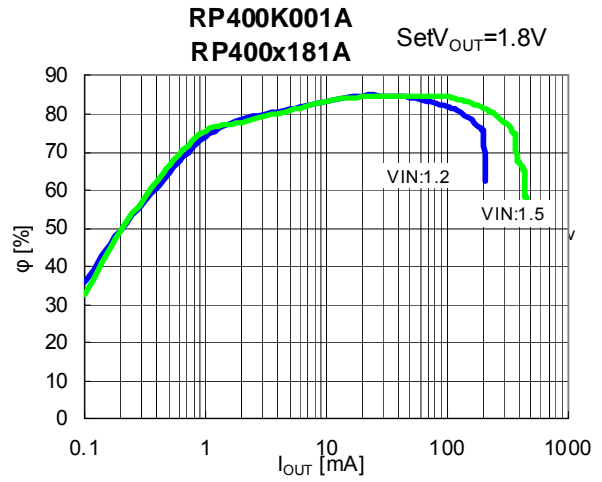

3) Quiescent Current 1 vs. Temperature

RP400K001A
RP400x501A

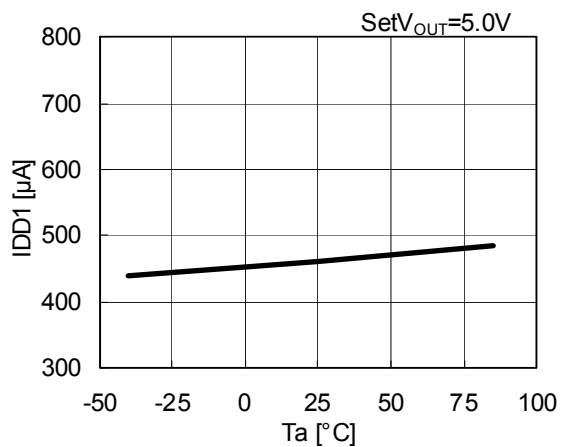

4) Quiescent Current 2 vs. Temperature

RP400K001A
RP400x501A

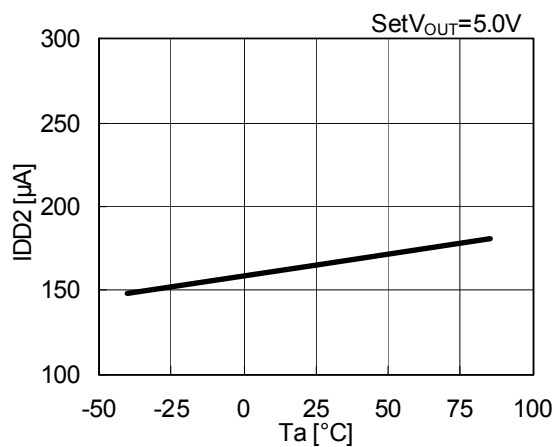

5) Maxduty vs. Temperature

RP400K001A
RP400xxx1A

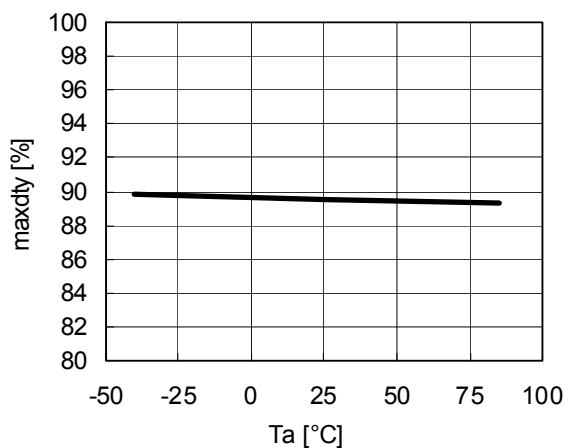

6) Start-up Voltage 2 vs. Temperature

RP400K001A
RP400xxx1A

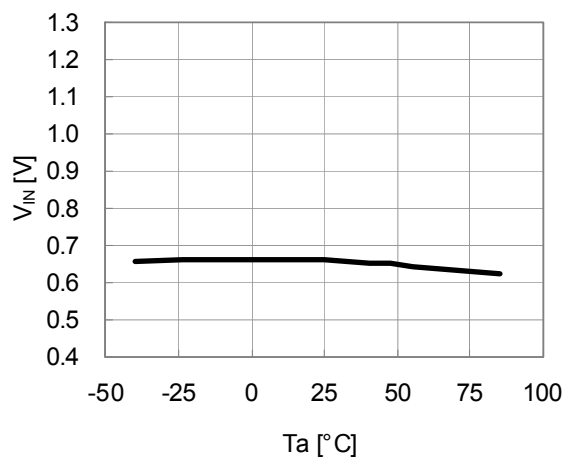

7) Start-up Voltage 3 vs. Temperature

RP400K001A
RP400xxx1A

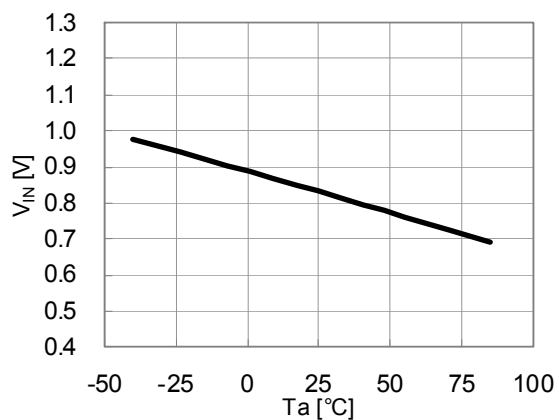

8) Soft-Start Period vs. Temperature

RP400K001A
RP400x331A

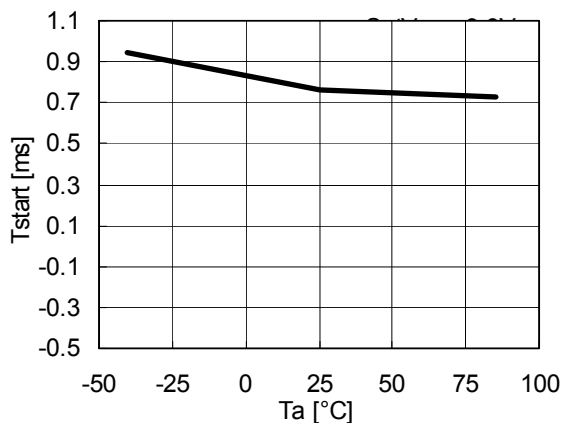

9) Switching Frequency vs. Temperature

RP400K001A
RP400xxx1A

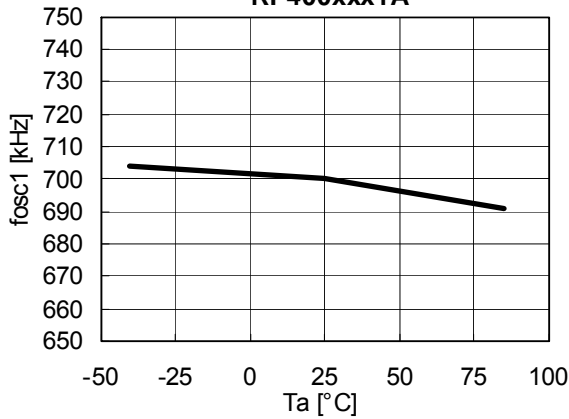

10) Lx Peak Current Limit vs. Duty

RP400K001A
RP400xxx1A

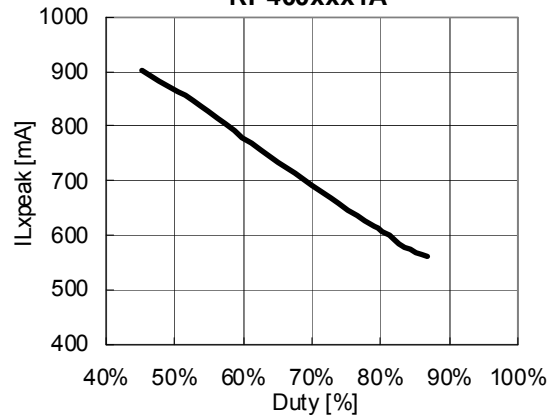

11) CE Input Voltage vs. Temperature

RP400K001A
RP400xxx1A

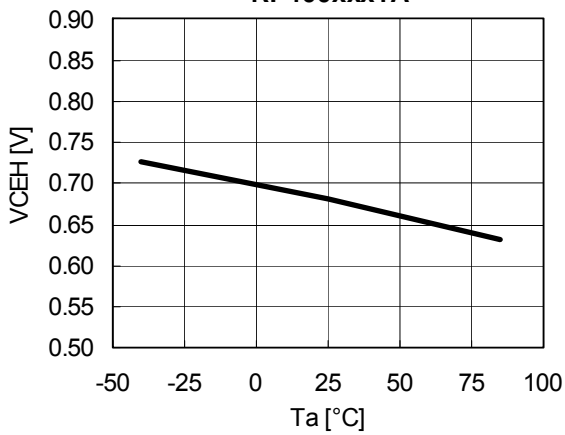

12) Feedback Voltage vs. Temperature

RP400x001A

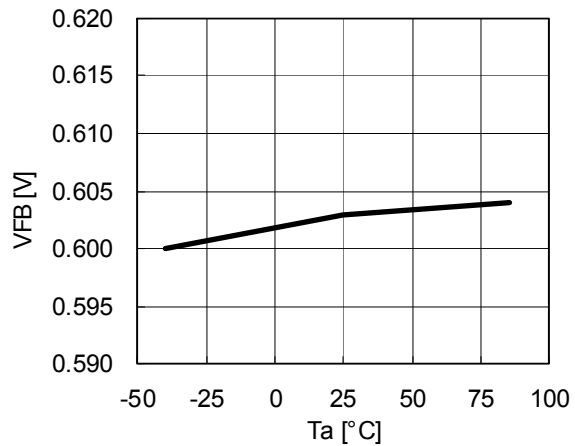

13) Start-up Waveform

RP400K001A
RP400x331A

set-V_{OUT} = 3.3V V_{IN} = 1.5V
Load = 1mA Ta = 25°C

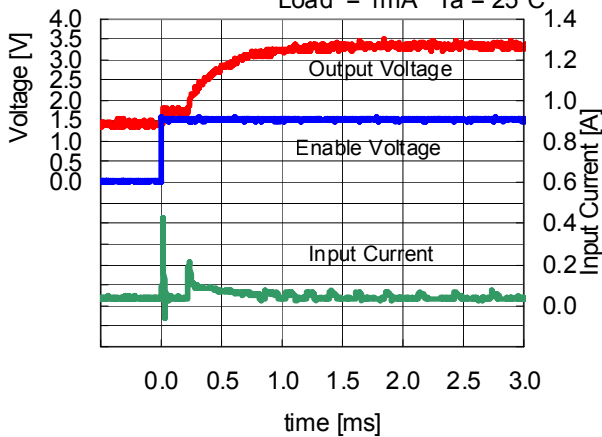

14) Load Response

RP400K001A
RP400x331A

V_{OUT} = 3.3V V_{IN} = 1.5V Ta = 25°C

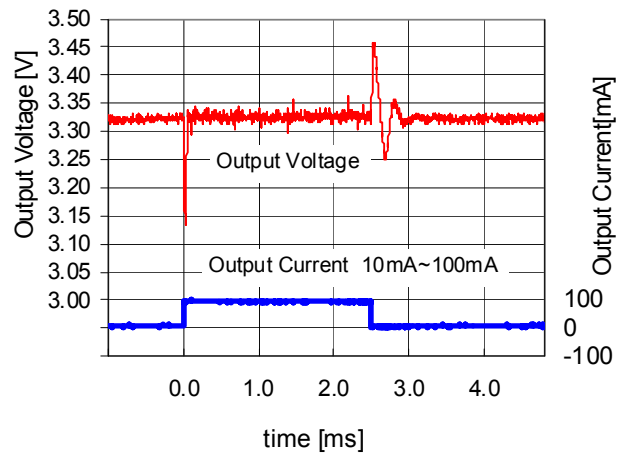

15) Output Voltage Waveform

RP400K001A
RP400x331A

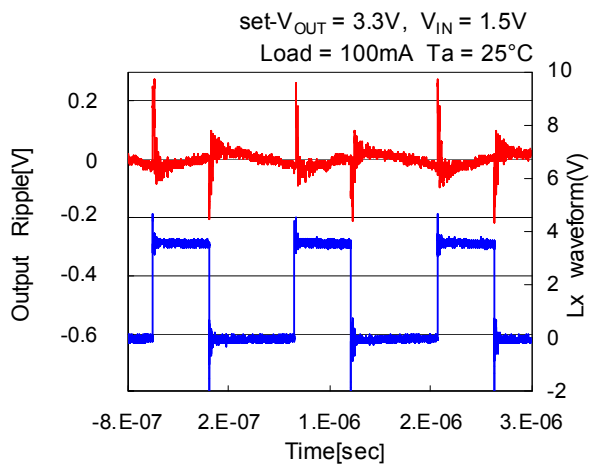

RP400K001A
RP400x331A

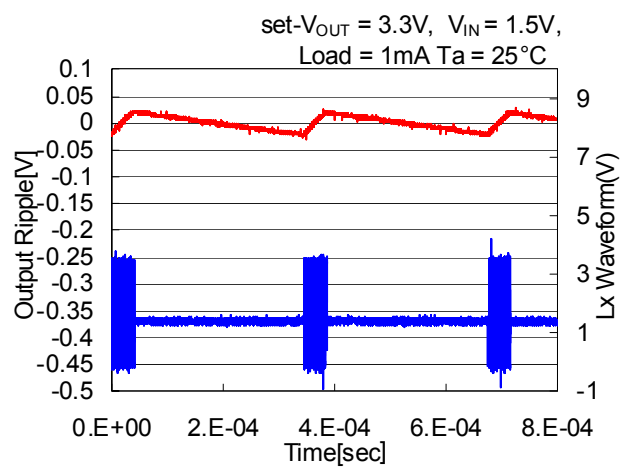

16) Hold-on Voltage 1

RP400K001A
RP400xxx1A

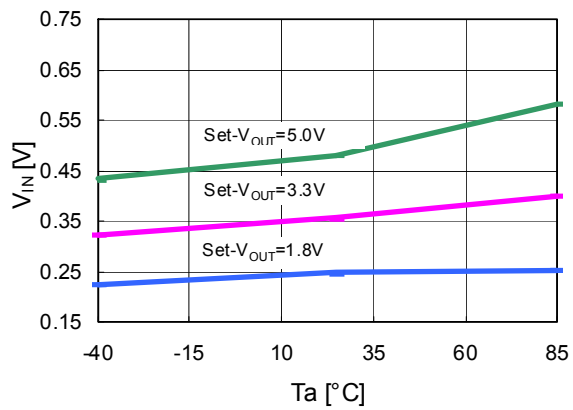



1. The products and the product specifications described in this document are subject to change or discontinuation of production without notice for reasons such as improvement. Therefore, before deciding to use the products, please refer to Ricoh sales representatives for the latest information thereon.
2. The materials in this document may not be copied or otherwise reproduced in whole or in part without prior written consent of Ricoh.
3. Please be sure to take any necessary formalities under relevant laws or regulations before exporting or otherwise taking out of your country the products or the technical information described herein.
4. The technical information described in this document shows typical characteristics of and example application circuits for the products. The release of such information is not to be construed as a warranty of or a grant of license under Ricoh's or any third party's intellectual property rights or any other rights.
5. The products listed in this document are intended and designed for use as general electronic components in standard applications (office equipment, telecommunication equipment, measuring instruments, consumer electronic products, amusement equipment etc.). Those customers intending to use a product in an application requiring extreme quality and reliability, for example, in a highly specific application where the failure or misoperation of the product could result in human injury or death (aircraft, spacevehicle, nuclear reactor control system, traffic control system, automotive and transportation equipment, combustion equipment, safety devices, life support system etc.) should first contact us.
6. We are making our continuous effort to improve the quality and reliability of our products, but semiconductor products are likely to fail with certain probability. In order to prevent any injury to persons or damages to property resulting from such failure, customers should be careful enough to incorporate safety measures in their design, such as redundancy feature, fire containment feature and fail-safe feature. We do not assume any liability or responsibility for any loss or damage arising from misuse or inappropriate use of the products.
7. Anti-radiation design is not implemented in the products described in this document.
8. Please contact Ricoh sales representatives should you have any questions or comments concerning the products or the technical information.



Ricoh is committed to reducing the environmental loading materials in electrical devices with a view to contributing to the protection of human health and the environment.

Ricoh has been providing RoHS compliant products since April 1, 2006 and Halogen-free products since April 1, 2012.

RICOH RICOH ELECTRONIC DEVICES CO., LTD.

<http://www.e-devices.ricoh.co.jp/en/>

Sales & Support Offices

RICOH ELECTRONIC DEVICES CO., LTD.

Higashi-Shinagawa Office (International Sales)
3-32-3, Higashi-Shinagawa, Shinagawa-ku, Tokyo 140-8655, Japan
Phone: +81-3-5479-2857 Fax: +81-3-5479-0502

RICOH EUROPE (NETHERLANDS) B.V.

Semiconductor Support Centre
Prof. W.H. Keesomlaan 1, 1183 DJ Amstelveen, The Netherlands
Phone: +31-20-5474-309

RICOH ELECTRONIC DEVICES KOREA CO., LTD.

3F, Haesung Bldg. 504, Teheran-ro, Gangnam-gu, Seoul, 135-725, Korea
Phone: +82-2-2135-5700 Fax: +82-2-2051-5713

RICOH ELECTRONIC DEVICES SHANGHAI CO., LTD.

Room 403, No.2 Building, No.690 Bilbo Road, Pu Dong New District, Shanghai 201203,
People's Republic of China
Phone: +86-21-5027-3200 Fax: +86-21-5027-3299

RICOH ELECTRONIC DEVICES CO., LTD.

Taipei office
Room 109, 10F-1, No.51, Hengyang Rd., Taipei City, Taiwan (R.O.C.)
Phone: +886-2-2313-1621/1622 Fax: +886-2-2313-1623

Mouser Electronics

Authorized Distributor

Click to View Pricing, Inventory, Delivery & Lifecycle Information:

[Ricoch Electronics:](#)

[RP400K001A-TR](#) [RP400N501A-TR-FE](#)



Компания «ЭлектроПласт» предлагает заключение долгосрочных отношений при поставках импортных электронных компонентов на взаимовыгодных условиях!

Наши преимущества:

- Оперативные поставки широкого спектра электронных компонентов отечественного и импортного производства напрямую от производителей и с крупнейших мировых складов;
- Поставка более 17-ти миллионов наименований электронных компонентов;
- Поставка сложных, дефицитных, либо снятых с производства позиций;
- Оперативные сроки поставки под заказ (от 5 рабочих дней);
- Экспресс доставка в любую точку России;
- Техническая поддержка проекта, помощь в подборе аналогов, поставка прототипов;
- Система менеджмента качества сертифицирована по Международному стандарту ISO 9001;
- Лицензия ФСБ на осуществление работ с использованием сведений, составляющих государственную тайну;
- Поставка специализированных компонентов (Xilinx, Altera, Analog Devices, Intersil, Interpoint, Microsemi, Aeroflex, Peregrine, Syfer, Eurofarad, Texas Instrument, Miteq, Cobham, E2V, MA-COM, Hittite, Mini-Circuits, General Dynamics и др.);

Помимо этого, одним из направлений компании «ЭлектроПласт» является направление «Источники питания». Мы предлагаем Вам помощь Конструкторского отдела:

- Подбор оптимального решения, техническое обоснование при выборе компонента;
- Подбор аналогов;
- Консультации по применению компонента;
- Поставка образцов и прототипов;
- Техническая поддержка проекта;
- Защита от снятия компонента с производства.



Как с нами связаться

Телефон: 8 (812) 309 58 32 (многоканальный)

Факс: 8 (812) 320-02-42

Электронная почта: org@eplast1.ru

Адрес: 198099, г. Санкт-Петербург, ул. Калинина, дом 2, корпус 4, литера А.