

UBX-310

Intelligent Compact Fanless BOX PC



Features

- Embedded in Intel Bay Trail J1900/Skylake Core i3/i5 processor
- Compact design with 45mm in height
- Easy/quick installation for additional peripherals and expanded modular
- Support 1 x 2.5" SATA HDD Bay and 1 mSATA
- Multiple IO ports is suitable for variety of applications.
- Lockable DC jack design
- Support wall/VESA mount
- Supports WISE-PaaS/RMM and Embedded Software APIs



Introduction

UBX-310, an intelligent, fanless embedded system powered by Intel® Celeron™ J1900/Skylake Core i3/i5 low power processor with multiple I/O interface. Fanless design can provide the user quiet operation environment and reduce the failure rate. These low-power platforms provide energy-efficient and environmentally responsible solutions, compact and fanless design and serve applications targeted at factory automation, machine automation, retail, kiosks, and self-service applications.

Specifications

		UBX-310D-L0B0E	UBX-310D-F0B0E	UBX-310F-I3B00	UBX-310F-I5B00
Processor	CPU	Baytrail J1900		Core i3-6100U	Core i5-6300U
	Max Speed	2.0GHZ, Turbe Boost up to 2.42GHZ		2.3GHZ	2.4GHZ
Memory	Technology	Single channel DDR3L 1333 MHz SDRAM		Single channel DDR4 2133 MHz SDRAM	
	Max Capacity	Up to 8GB		Up to 16GB	
	Socket	1 x 260-pin S0-DIMM		1 x 260-pin S0-DIMM	
Graphic	Capacity	Integrated Intel® HD Graphics Engine			
	HDMI	Max. resolution 1920 x 1200 @ 60 Hz		Max. resolution 3840 x 2160 @30Hz	
	VGA	Up to SXGA 2560 x 1600 @ 60 Hz		Up to SXGA 2048 x 1152 @ 60 Hz	
Ethernet	Interface	10/100/1000 Mbps		10/100/1000 Mbps	
	Controller	Realtek RTL8111E GbE LAN		I219LM/I211AT GbE LAN	
Audio	Interface	Realtek ALC269		Realtek ALC892	
Front IO	USB2.0	1	1	1	
	USB3.0	NA	1	NA	
	Serial	NA	3	NA	
Rear IO	VGA	1		1	
	HDMI	1		1	
	RJ-45	1		2	
	USB	4 x USB2.0		4 x USB3.0, 2 x USB2.0	
	Serial	3 (COM3 support 5V/12V Power by order)		4 (COM1&COM2 support 5V/12V Power, COM2 support RS232/422/485 by order)	
	LPT	1		NA	
	RJ11	1, cash drawer default 24V		1, cash drawer default 12V	
	Audio	1 x Line-out, 1 x Mic-in		1 x Line-out, 1 x Mic-in	
Expantion	DC Jack	1		1	
	Mini PCIe	1 x F/S MiniPCIe		2 x F/S MiniPCIe	
Storage	SATA3.0	1 x 2.5-inch SATA 2.0 HDD/SSD (7mm height)		1 x 2.5-inch SATA3.0 HDD/SSD (7mm height)	
	mSATA	1		2	
Power	Requirement	ATX Mode, AC to DC, DC 12V/5A, 60W			
Miscellaneous	Dimension (L x W x H)	245 x 185 x 45 mm			
	Weight	2.0kg			
Mounting Mode	Accessories	Wall /VESA mount			
Software	OS	Win7, Win10, POSReady7, Linux Kernel 3.13 or above			
Environment	Operating Temperature	0 ~ 40 °C			
	Storage Temperature	-40 ~ 85 °C (-40 ~ 185 °F)			
	Relative Humidity	90% @ 40 °C (non-condensing)			
	Vibration during operation	With HDD:0.5Grms, IEC 60068-2-64, random 5-500HZ, 3 axes, 1hr/axis			
Certification	Shock during operation	With HDD:10 G, IEC 60068-2-27, half sine, 11 ms duration			
		CCC/BSMI/CE/FCC/UL/CB			

Dimensions

Unit: mm

UBX-310D

UBX-310F

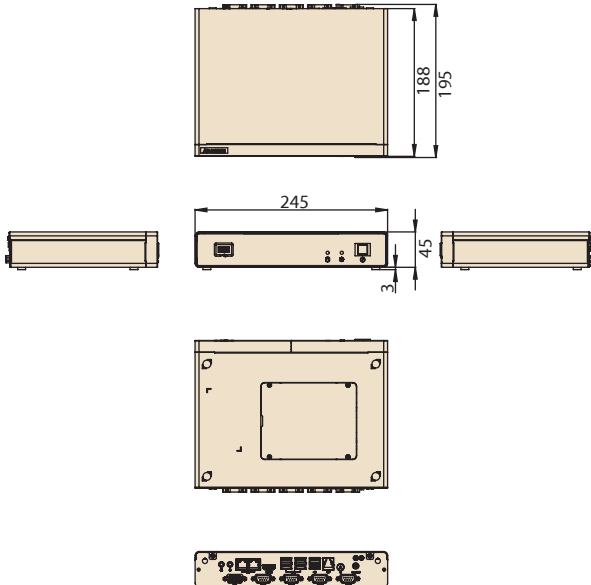
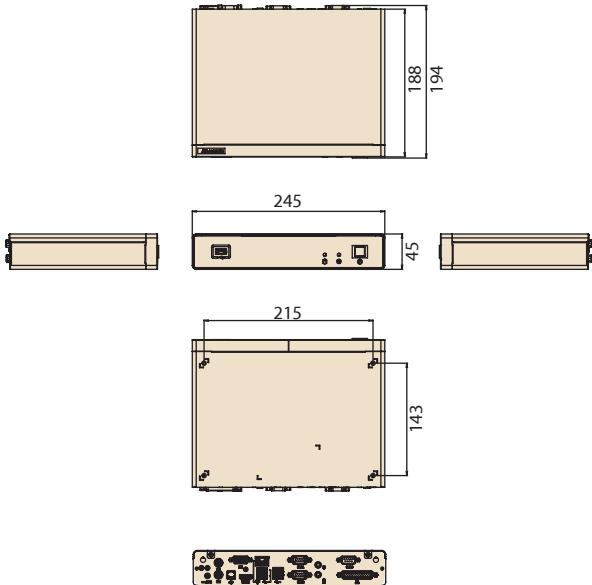

Fully- Integrated I/O

UBX-310D-LOB0E

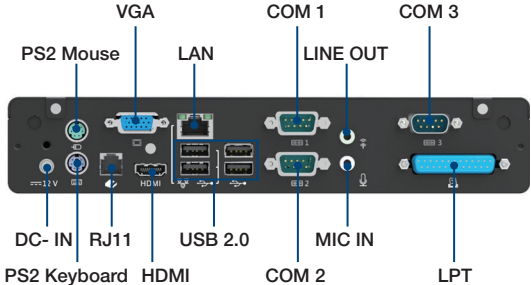
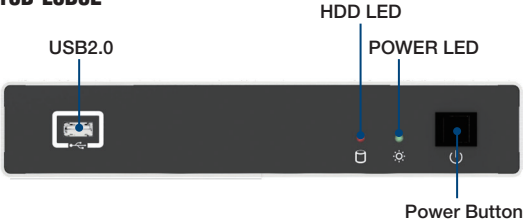

UBX-310D-F0B0E

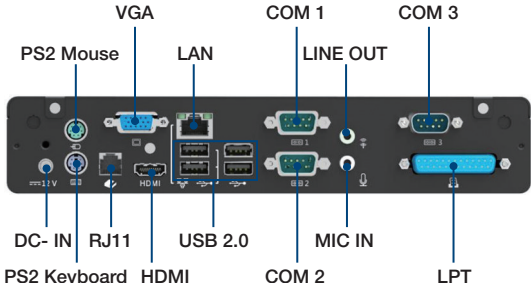
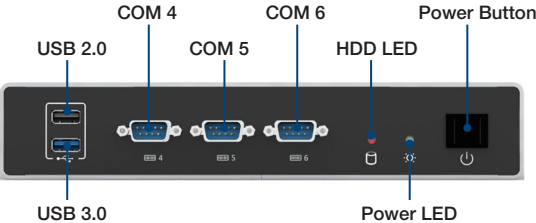

Fully- Integrated I/O

UBX-310F

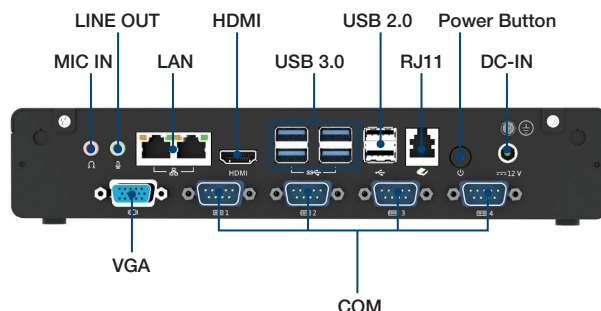

Ordering Information

PN	Description
UBX-310D-L0B0E	Intel Baytrail J1900 Fanless Mini Box PC w/o RAM and Storage
UBX-310D-F0B0E	Intel Baytrail J1900 Fanless Mini Box PC with extended IO configuration, w/o RAM and Storage
UBX-310D-LOU0E	Intel Baytrail J1900 Fanless Mini Box PC w/o RAM and Storage, special for USA
UBX-310F-I3B00	Intel Skylake Core i3 6100U Fanless Mini Box PC w/o RAM and Storage
UBX-310F-I5B00	Intel Skylake Core i5 6300U, Fanless Mini PC w/o RAM and Storage

Accessory

Accessory	PN	Description
Memory	AQD-SD3L4GN16-SG	For J1900 version, 4G, DDR3 204PIN 1600Mhz SO DIMM
	AQD-SD4U4GN24-SG	For Core i3/i5 version, 4G, DDR4 260 PIN 2400 Mhz SODIMM
	AQD-SD4U8GN24-SE	For Core i3/i5 version, 8G, DDR4 260 PIN 2400 Mhz SODIMM
Storage	SQF-S25M4-64G-S9C	SQF 2.5" SSD 630 64G MLC (0~70°C)
	SQF-S25M4-32G-S9C	SQF 2.5" SSD 630 32G MLC (0~70°C)
	SQF-S25M4-128G-S9C	SQF 2.5" SSD 630 128G MLC (0~70°C)
	SQF-S25V2-128G-SBC	SQF 2.5" SATA SSD 640 128G BiCS3 3D NAND (0~70°C)
	96ND500G-ST-SG5KA1	SEAGATE 500G 2.5" SATAIII 5KRPM 16M(G)24*7
	SQF-SMSM4-64G-S9C	SQF MSATA 630 64G MLC (0~70°C)
	SQF-SMSM4-32G-S9C	SQF MSATA 630 32G MLC (0~70°C)
Wifi Module	EWM-W135F01E	802.11 a/b/g/n, Atheros AR9382, 2T2R Full size Mini PCIe
	1750005885*2	Internal antenna L=23cm SMALFR8-3230A-00X00R
	1750008717-01*2	Dipole Ant. D.B 2.4/5G WIFI 3dBi SMA/M-R BLK(outer antenna)
Power Cord	96CB-POEWR-B-1.8M1	Power Cord(China), 3P 1.8M, BK(CCC)
	17AP164900518011	Power Cord CEE 7/16+C13 10A/16A 250V L1.8M(CE)
	1700013977	Power Cord 10A 250V 3P 180/90 CCC 200cm(CCC)
	1702002600	Power Cord 3P UL/CSA 10A 125V 1.83M 180D(USA)
	1702002605	Power Cord 2P FRANCE 10A 250V 1.83M 90D(EU)
	1700001714	Power Cord BSMI 3P 7A 125V 18AWG 180CM(BSMI)
	1700000237	Power Cord 3P PSE 12A 125V 1.83M(Japan)
	1700018704	Power Cord BSI 3P 10A 250V 180cm(UK)
Mount Kit	HIP-33B-MOUNT1E	VESA MOUNT for UBX-310
Windows OS for UBX-310F	2070015073	Image POSReady7 UBX-310F V1.00 3MUI 64Bit
	2070015074	Image WIN7PSP1 UBX-310F V1.00 3MUI 64Bit
	2070015075	Img WIN10 LTSB-6(I3I5) UBX-310F V1.00 3MUI 64Bit
Windows OS for UBX-310D	2070014259	Image PODREADY7 UBX-310D V1.00 ENG CHS 32Bit
	2070014374	Image WES7P UBX-310D V1.00 ENG CHS 64Bit
	2070014375	Image WES7P UBX-310D V1.00 ENG CHS 32Bit
	2070014571	img Win7Pro UBX-310D X32 V1.0 SimpChn (ChinaBP)
	2070015072	Image WES7P UBX-310D V1.00 3MUI 64Bit
	20708WX6ES0006	Img WIN10 LTSB-6-U UBX-310D V1.00 7MUI 64Bit



Компания «ЭлектроПласт» предлагает заключение долгосрочных отношений при поставках импортных электронных компонентов на взаимовыгодных условиях!

Наши преимущества:

- Оперативные поставки широкого спектра электронных компонентов отечественного и импортного производства напрямую от производителей и с крупнейших мировых складов;
- Поставка более 17-ти миллионов наименований электронных компонентов;
- Поставка сложных, дефицитных, либо снятых с производства позиций;
- Оперативные сроки поставки под заказ (от 5 рабочих дней);
- Экспресс доставка в любую точку России;
- Техническая поддержка проекта, помощь в подборе аналогов, поставка прототипов;
- Система менеджмента качества сертифицирована по Международному стандарту ISO 9001;
- Лицензия ФСБ на осуществление работ с использованием сведений, составляющих государственную тайну;
- Поставка специализированных компонентов (Xilinx, Altera, Analog Devices, Intersil, Interpoint, Microsemi, Aeroflex, Peregrine, Syfer, Eurofarad, Texas Instrument, Miteq, Cobham, E2V, MA-COM, Hittite, Mini-Circuits, General Dynamics и др.);

Помимо этого, одним из направлений компании «ЭлектроПласт» является направление «Источники питания». Мы предлагаем Вам помощь Конструкторского отдела:

- Подбор оптимального решения, техническое обоснование при выборе компонента;
- Подбор аналогов;
- Консультации по применению компонента;
- Поставка образцов и прототипов;
- Техническая поддержка проекта;
- Защита от снятия компонента с производства.



Как с нами связаться

Телефон: 8 (812) 309 58 32 (многоканальный)

Факс: 8 (812) 320-02-42

Электронная почта: org@eplast1.ru

Адрес: 198099, г. Санкт-Петербург, ул. Калинина, дом 2, корпус 4, литера А.