

# GW P7STA2.EM

## OSCONIQ® P 7070

Ultra high power LED with high performance, superior robustness and long lifetime.

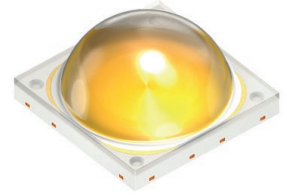

### Applications

- Architecture
- Area Lights
- Highbay Industrial
- Street, Tunnel and Outdoor

### Features:

- Package: New SMD epoxy package with silicone lens
- Typ. Radiation: 120° (Lambertian emitter)
- Color temperature: 2700K - 5700K
- CRI: 80 (min.), 82 (typ.)
- ESD: 8 kV acc. to ANSI/ESDA/JEDEC JS-001 (HBM, Class 3B)
- Luminous Flux : typ. 1032 lm @ 3000 K, 85 °C
- Luminous efficacy : typ. 128 lm/W @ 3000 K, 85 °C

## Ordering Information

Type	Color temperature	Luminous Flux <sup>1)</sup> $I_F = 1400 \text{ mA}$ $\Phi_V$	Ordering Code
GW P7STA2.EM-UGUH-27S5-1	2700 K	920 ... 1000 lm	Q65112A6660
GW P7STA2.EM-UHUJ-27S5-1	2700 K	960 ... 1040 lm	Q65112A6659
GW P7STA2.EM-UHUJ-30S5-1	3000 K	960 ... 1040 lm	Q65112A6658
GW P7STA2.EM-UJVF-30S5-1	3000 K	1000 ... 1080 lm	Q65112A6657
GW P7STA2.EM-UJVF-35S5-1	3500 K	1000 ... 1080 lm	Q65112A6682
GW P7STA2.EM-VFVG-35S5-1	3500 K	1040 ... 1120 lm	Q65112A6681
GW P7STA2.EM-VFVG-40S5-1	4000 K	1040 ... 1120 lm	Q65112A6680
GW P7STA2.EM-VGVH-40S5-1	4000 K	1080 ... 1160 lm	Q65112A6677
GW P7STA2.EM-VFVG-50S5-1	5000 K	1040 ... 1120 lm	Q65112A6679
GW P7STA2.EM-VGVH-50S5-1	5000 K	1080 ... 1160 lm	Q65112A6676
GW P7STA2.EM-VFVG-57S5-1	5700 K	1040 ... 1120 lm	Q65112A6678
GW P7STA2.EM-VGVH-57S5-1	5700 K	1080 ... 1160 lm	Q65112A6675

## Maximum Ratings

Parameter	Symbol		Values
Operating Temperature	$T_{op}$	min.	-40 °C
		max.	125 °C
Storage Temperature	$T_{stg}$	min.	-40 °C
		max.	125 °C
Junction Temperature	$T_j$	max.	135 °C
Forward Current $T_j = 85\text{ °C}$	$I_F$	min.	400 mA
		max.	2100 mA
Surge Current $t \leq 10\ \mu\text{s}$ ; $D = 0.005$ ; $T_j = 85\text{ °C}$	$I_{FS}$	max.	3000 mA
Reverse current <sup>2)</sup>	$I_R$	max.	200 mA
ESD withstand voltage acc. to ANSI/ESDA/JEDEC JS-001 (HBM, Class 3B)	$V_{ESD}$		8 kV

## Characteristics

$I_F = 1400 \text{ mA}$ ;  $T_J = 85 \text{ °C}$

Parameter	Symbol		Values
Viewing angle at 50% $I_V$	$2\phi$	typ.	120 °
Forward Voltage <sup>3)</sup>	$V_F$	min. typ. max.	5.25 V 5.74 V 6.00 V
Reverse voltage (ESD device)	$V_{R\text{ESD}}$	min.	45 V
Reverse voltage <sup>2)</sup> $I_R = 20 \text{ mA}$	$V_R$	max.	1.2 V
Color Rendering Index <sup>4)</sup> (2700K - 5700K)	CRI	min. typ.	80 82
Electrical thermal resistance junction/solderpoint with efficiency $\eta_e = 39 \%$	$R_{\text{thJS elec.}}$	typ.	0.52 K / W

## Brightness Groups

Group	Luminous Flux <sup>1)</sup> $I_F = 1400 \text{ mA}$ min. $\Phi_V$	Luminous Flux <sup>1)</sup> $I_F = 1400 \text{ mA}$ max. $\Phi_V$
UG	920 lm	960 lm
UH	960 lm	1000 lm
UJ	1000 lm	1040 lm
VF	1040 lm	1080 lm
VG	1080 lm	1120 lm
VH	1120 lm	1160 lm

## Forward Voltage Groups

Group	Forward Voltage <sup>3)</sup> min. $V_F$	Forward Voltage <sup>3)</sup> max. $V_F$
DE	5.25 V	5.50 V
EE	5.50 V	5.75 V
FE	5.75 V	6.00 V

## Chromaticity Coordinate Groups <sup>5)</sup>

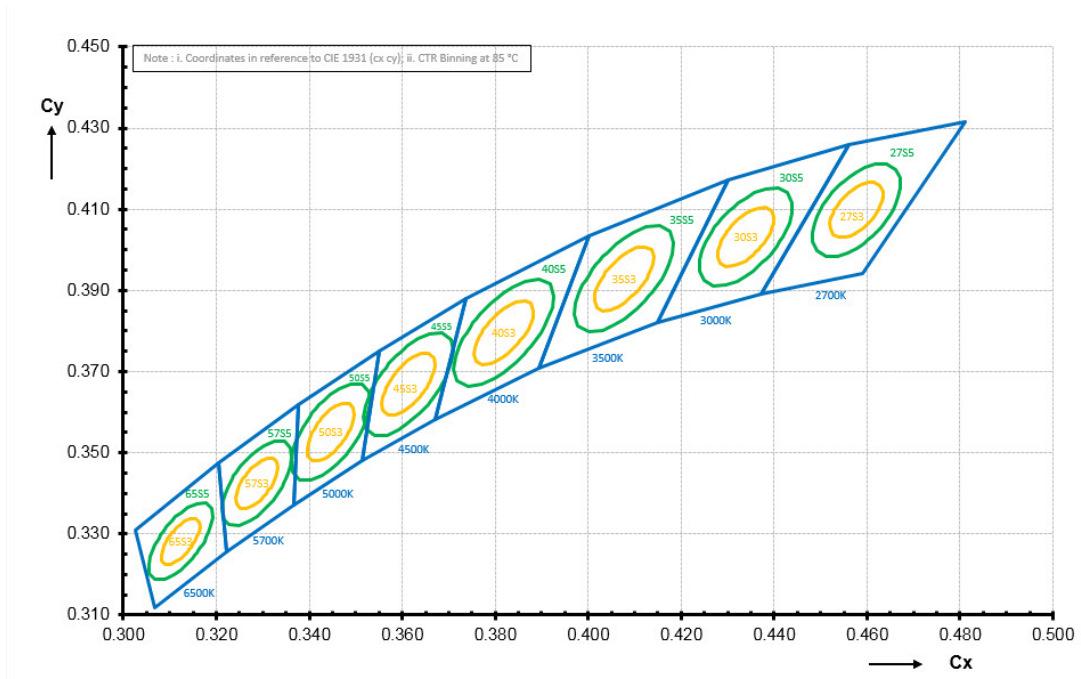

## Chromaticity Coordinate Groups

CCT	Center Cx	Center Cy	a	b	Ø
27S3 K	0.4577	0.4098	0.008	0.0041	54.1
27S5 K	0.4577	0.4098	0.0133	0.0068	54.1
30S3 K	0.4339	0.4032	0.0086	0.0042	53.7
30S5 K	0.4339	0.4032	0.0142	0.0069	53.7
35S3 K	0.4077	0.3929	0.0093	0.0042	53.9
35S5 K	0.4077	0.3929	0.0155	0.0069	53.9
40S3 K	0.3818	0.3796	0.0094	0.0041	53.4
40S5 K	0.3818	0.3796	0.0157	0.0068	53.4
50S3 K	0.3446	0.3551	0.0081	0.0035	59.8
50S5 K	0.3446	0.3551	0.0135	0.0059	59.8
57S3 K	0.3287	0.3425	0.0072	0.0032	58.8
57S5 K	0.3287	0.3425	0.0119	0.0052	58.8

Discontinued

---

## Group Name on Label

**Example: UG-DE**

Brightness

Forward Voltage

---

UG

DE

---

**Relative Spectral Emission** <sup>6)</sup>

$\Phi_{rel} = f(\lambda); I_F = 1400 \text{ mA}; T_J = 85 \text{ }^\circ\text{C}$

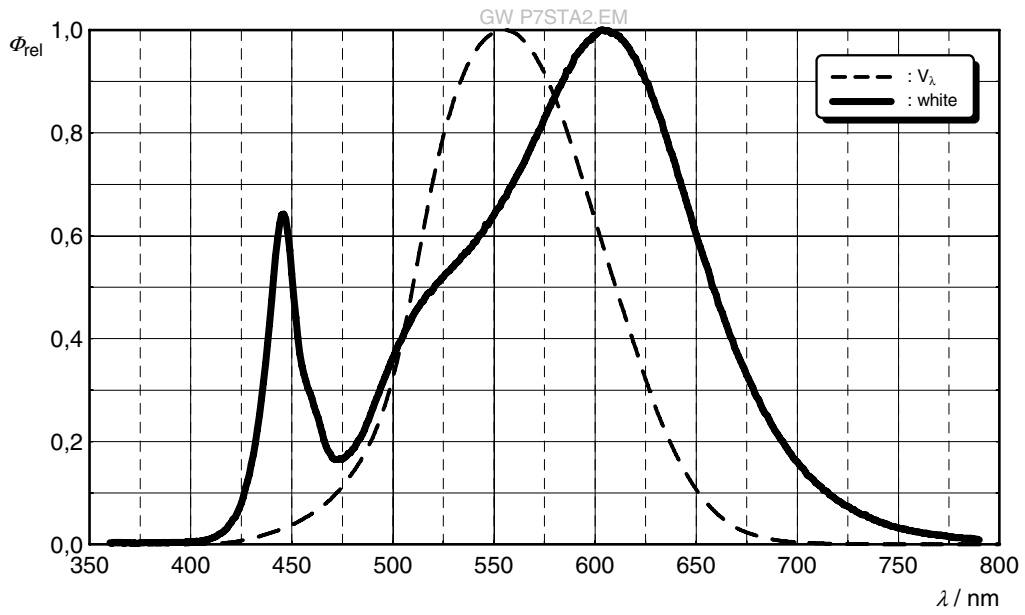

**Radiation Characteristics** <sup>6)</sup>

$I_{rel} = f(\phi); T_J = 85 \text{ }^\circ\text{C}$

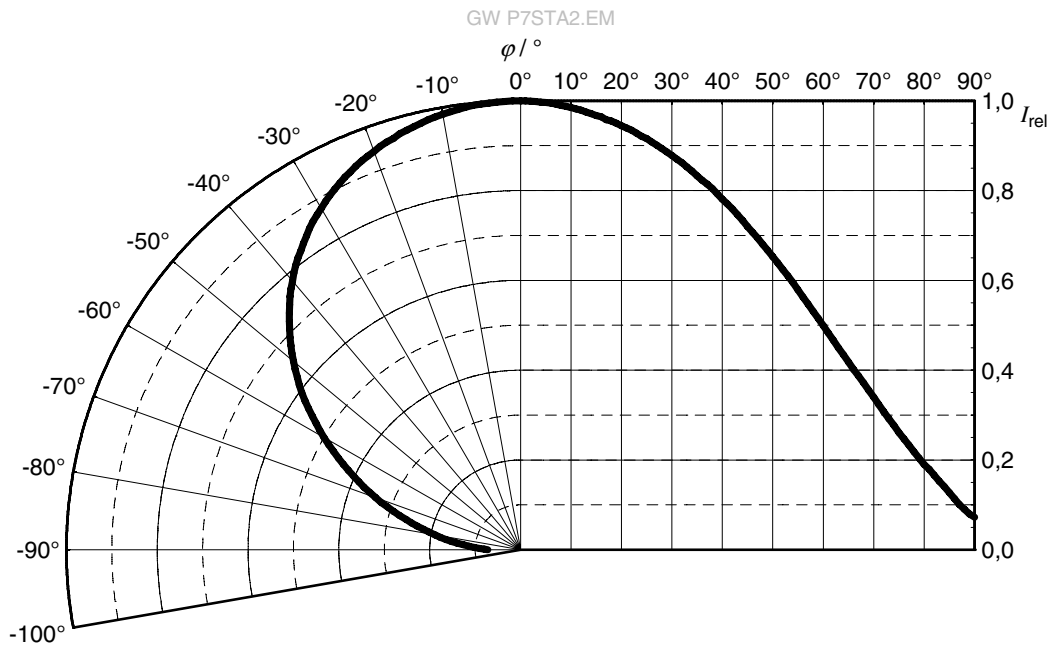

Discontinued



**Forward current** 6), 7)

$I_F = f(V_F); T_J = 85\text{ °C}$

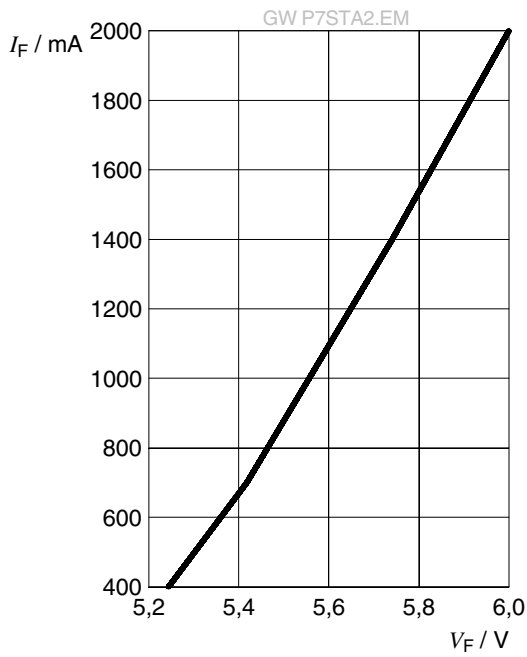

**Relative Luminous Flux** 6), 7)

$\Phi_V / \Phi_V(1400\text{ mA}) = f(I_F); T_J = 85\text{ °C}$

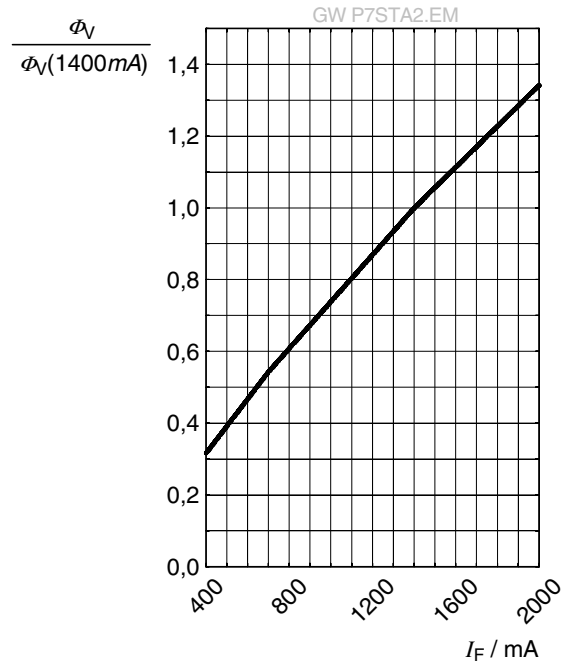

**Chromaticity Coordinate Shift** 6)

$\Delta Cx, \Delta Cy = f(I_F); T_J = 85\text{ °C}$

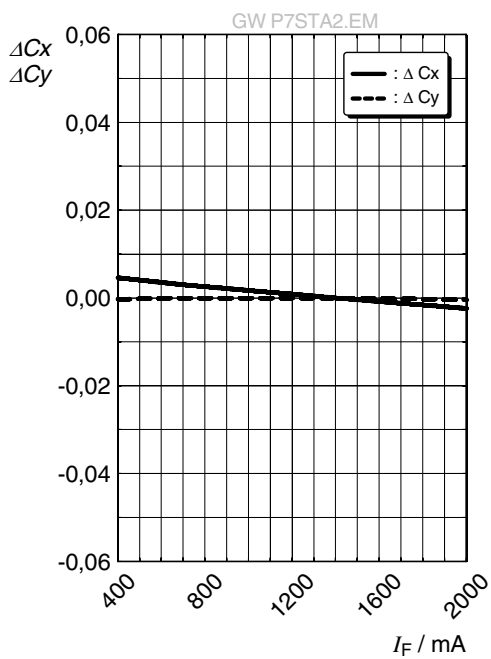

Discontinued

**Forward Voltage** <sup>6)</sup>

$\Delta V_F = V_F - V_F(85^\circ\text{C}) = f(T_j); I_F = 1400\text{ mA}$

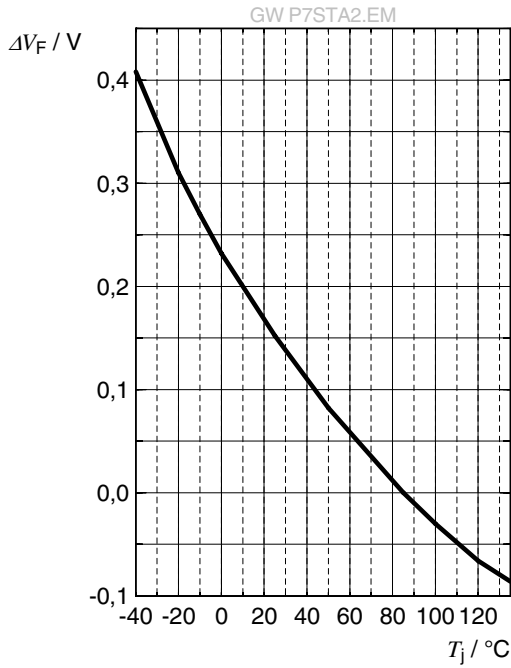

**Relative Luminous Flux** <sup>6)</sup>

$\Phi_v / \Phi_v(85^\circ\text{C}) = f(T_j); I_F = 1400\text{ mA}$

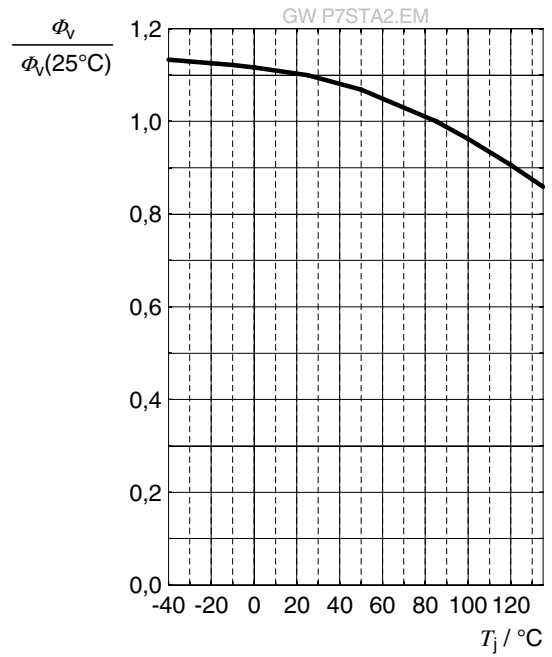

**Chromaticity Coordinate Shift** <sup>6)</sup>

$\Delta C_x, \Delta C_y = f(T_j); I_F = 1400\text{ mA}$

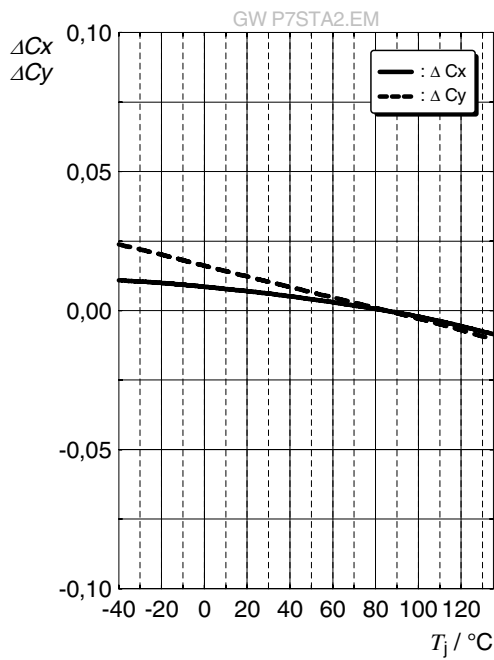

Discontinued

## Max. Permissible Forward Current

$$I_F = f(T)$$

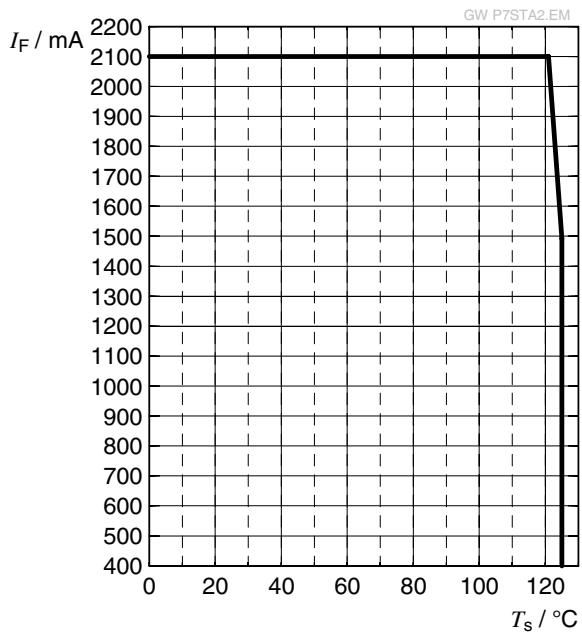

**Dimensional Drawing** <sup>8)</sup>

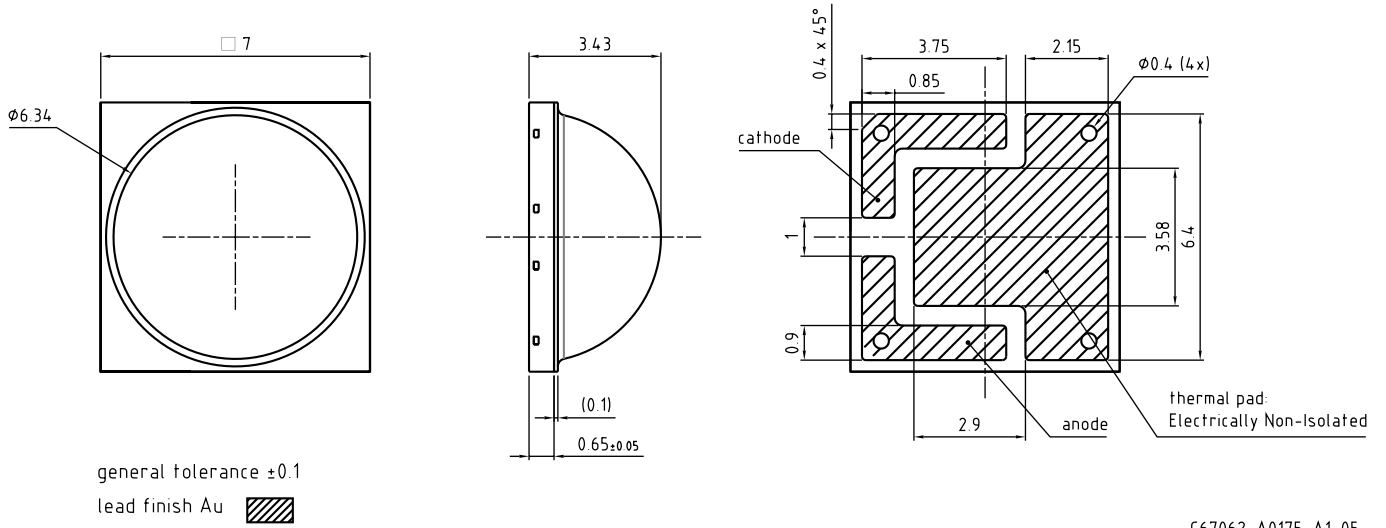

C67062-A0175-A1-05

**Further Information:**

**Approximate Weight:** 184.0 mg

**ESD advice:** The device is protected by ESD device which is connected in parallel to the Chip.

Recommended Solder Pad 8)

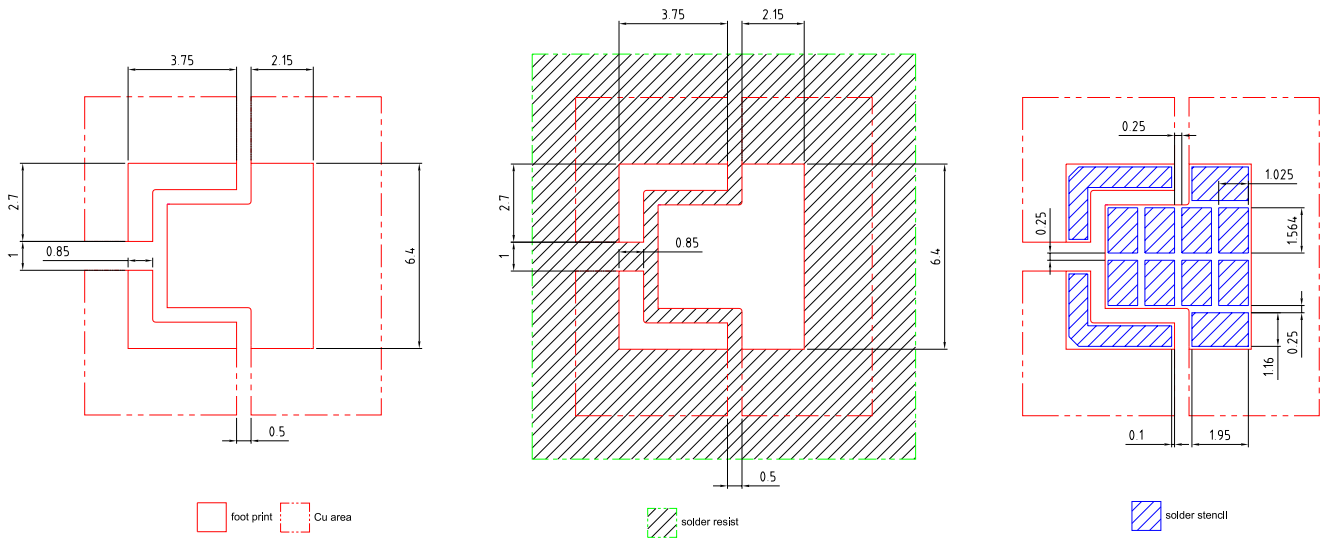

E067.0346.03-02

For superior solder joint connectivity results we recommend soldering under standard nitrogen atmosphere. Package not suitable for ultra sonic cleaning.

Discontinued

## Reflow Soldering Profile

Product complies to MSL Level 2 acc. to JEDEC J-STD-020E



Profile Feature	Symbol	Pb-Free (SnAgCu) Assembly			Unit
		Minimum	Recommendation	Maximum	
Ramp-up rate to preheat <sup>*)</sup> 25 °C to 150 °C			2	3	K/s
Time $t_s$ $T_{Smin}$ to $T_{Smax}$	$t_s$	60	100	120	s
Ramp-up rate to peak <sup>*)</sup> $T_{Smax}$ to $T_p$			2	3	K/s
Liquidus temperature	$T_L$		217		°C
Time above liquidus temperature	$t_L$		80	100	s
Peak temperature	$T_p$		245	250	°C
Time within 5 °C of the specified peak temperature $T_p - 5$ K	$t_p$	10	20	30	s
Ramp-down rate* $T_p$ to 100 °C			3	4	K/s
Time 25 °C to $T_p$				480	s

All temperatures refer to the center of the package, measured on the top of the component  
 \*) slope calculation  $DT/Dt$ :  $Dt$  max. 5 s; fulfillment for the whole T-range

Discontinued

**Taping** <sup>8)</sup>

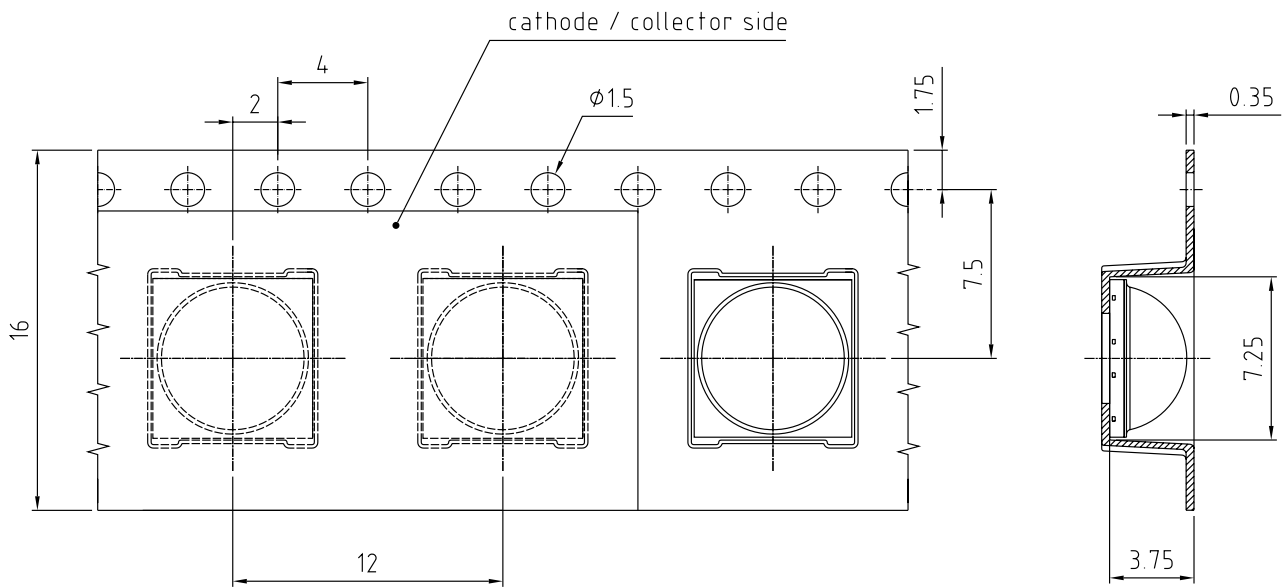

C67062-A0175-B2-05

**Tape and Reel** <sup>9)</sup>



**Reel Dimensions**

A	W	N <sub>min</sub>	W <sub>1</sub>	W <sub>2 max</sub>	Pieces per PU
330 mm	16 + 0.3 / - 0.1 mm	60/100 mm	16.4 + 2 mm	22.4 mm	600

Discontinued



### Barcode-Product-Label (BPL)

**OSRAM Opto Semiconductors** LX XXXX BIN1: XX-XX-X-XXX-X

RoHS Compliant

(6P) BATCH NO: 1234567890 ML Temp ST  
X XXX °C X

(1T) LOT NO: 1234567890 (9D) D/C: 1234 Pack: RXX  
DEMY XXX  
X\_X123\_1234.1234 X

(X) PROD NO: 123456789(Q)QTY: 9999 (G) GROUP: XX-XX-X-X

The diagram shows a rectangular label with rounded corners. It contains the OSRAM logo and product name at the top left. To the right are fields for 'LX XXXX' and 'BIN1: XX-XX-X-XXX-X'. Below the logo is a 'RoHS Compliant' statement. The label features three horizontal barcode sections. The first is labeled '(6P) BATCH NO: 1234567890' and is accompanied by a 'No moisture' symbol and 'ML Temp ST X XXX °C X'. The second is labeled '(1T) LOT NO: 1234567890' and '(9D) D/C: 1234', with 'Pack: RXX', 'DEMY XXX', and 'X\_X123\_1234.1234 X' to its right. The third is labeled '(X) PROD NO: 123456789(Q)QTY: 9999' and '(G) GROUP: XX-XX-X-X'. A QR code is located on the right side of the label.

OHA04563

### Dry Packing Process and Materials <sup>8)</sup>



OHA00539

Moisture-sensitive product is packed in a dry bag containing desiccant and a humidity card according JEDEC-STD-033.

Discontinued

## Notes

The evaluation of eye safety occurs according to the standard IEC 62471:2006 (photo biological safety of lamps and lamp systems). Within the risk grouping system of this IEC standard, the device specified in this data sheet falls into the class **moderate risk (exposure time 0.25 s)**. Under real circumstances (for exposure time, conditions of the eye pupils, observation distance), it is assumed that no endangerment to the eye exists from these devices. As a matter of principle, however, it should be mentioned that intense light sources have a high secondary exposure potential due to their blinding effect. When looking at bright light sources (e.g. headlights), temporary reduction in visual acuity and afterimages can occur, leading to irritation, annoyance, visual impairment, and even accidents, depending on the situation.

Subcomponents of this device contain, in addition to other substances, metal filled materials including silver. Metal filled materials can be affected by environments that contain traces of aggressive substances. Therefore, we recommend that customers minimize device exposure to aggressive substances during storage, production, and use. Devices that showed visible discoloration when tested using the described tests above did show no performance deviations within failure limits during the stated test duration. Respective failure limits are described in the IEC60810.

This device is designed for specific/recommended applications only. Please consult OSRAM Opto Semiconductors Sales Staff in advance for detailed information on other non-recommended applications (e.g. automotive).

Change management for this component is aligned with the requirements of the lighting market.

For further application related information please visit [www.osram-os.com/appnotes](http://www.osram-os.com/appnotes)

## Disclaimer

### Attention please!

The information describes the type of component and shall not be considered as assured characteristics. Terms of delivery and rights to change design reserved. Due to technical requirements components may contain dangerous substances.

For information on the types in question please contact our Sales Organization.

If printed or downloaded, please find the latest version on the OSRAM OS website.

### Packing

Please use the recycling operators known to you. We can also help you – get in touch with your nearest sales office. By agreement we will take packing material back, if it is sorted. You must bear the costs of transport. For packing material that is returned to us unsorted or which we are not obliged to accept, we shall have to invoice you for any costs incurred.

### Product and functional safety devices/applications or medical devices/applications

OSRAM OS components are not developed, constructed or tested for the application as safety relevant component or for the application in medical devices.

OSRAM OS products are not qualified at module and system level for such application.

In case buyer – or customer supplied by buyer – considers using OSRAM OS components in product safety devices/applications or medical devices/applications, buyer and/or customer has to inform the local sales partner of OSRAM OS immediately and OSRAM OS and buyer and /or customer will analyze and coordinate the customer-specific request between OSRAM OS and buyer and/or customer.

## Glossary

- 1) **Brightness:** Brightness values are measured during a current pulse of typically 10 ms, with a tolerance of +/- 7%.
- 2) **Reverse Operation:** Reverse Operation of 10 hours is permissible in total. Continuous reverse operation is not allowed.
- 3) **Forward Voltage:** The Forward voltage is measured during a current pulse duration of typically 1 ms with a tolerance of  $\pm 0.05V$ .
- 4) **Color reproduction index:** Color reproduction index values (CRI-RA) are measured during a current pulse of typically 10 ms and with a tolerance of  $\pm 2$ .
- 5) **Chromaticity coordinate groups:** Chromaticity coordinate groups are measured during a current pulse duration of typically 10ms with a tolerance of  $\pm 0.005$ .
- 6) **Typical Values:** Due to the special conditions of the manufacturing processes of semiconductor devices, the typical data or calculated correlations of technical parameters can only reflect statistical figures. These do not necessarily correspond to the actual parameters of each single product, which could differ from the typical data and calculated correlations or the typical characteristic line. If requested, e.g. because of technical improvements, these typ. data will be changed without any further notice.
- 7) **Characteristic curve:** In the range where the line of the graph is broken, you must expect higher differences between single devices within one packing unit.
- 8) **Tolerance of Measure:** Unless otherwise noted in drawing, tolerances are specified with  $\pm 0.1$  and dimensions are specified in mm.
- 9) **Tape and Reel:** All dimensions and tolerances are specified acc. IEC 60286-3 and specified in mm.

---

## Revision History

Version	Date	Change
1.0	2018-12-07	Initial Version
1.1	2020-02-21	Schematic Transportation Box Dimensions of Transportation Box
1.1	2020-03-23	Discontinued

**Published by OSRAM Opto Semiconductors GmbH** EU RoHS and China RoHS compliant product  
**Leibnizstraße 4, D-93055 Regensburg**  
**www.osram-os.com © All Rights Reserved.**



此产品符合欧盟 RoHS 指令的要求；  
按照中国的相关法规和标准，不含有毒有害物质或元素。



Компания «ЭлектроПласт» предлагает заключение долгосрочных отношений при поставках импортных электронных компонентов на взаимовыгодных условиях!

Наши преимущества:

- Оперативные поставки широкого спектра электронных компонентов отечественного и импортного производства напрямую от производителей и с крупнейших мировых складов;
- Поставка более 17-ти миллионов наименований электронных компонентов;
- Поставка сложных, дефицитных, либо снятых с производства позиций;
- Оперативные сроки поставки под заказ (от 5 рабочих дней);
- Экспресс доставка в любую точку России;
- Техническая поддержка проекта, помощь в подборе аналогов, поставка прототипов;
- Система менеджмента качества сертифицирована по Международному стандарту ISO 9001;
- Лицензия ФСБ на осуществление работ с использованием сведений, составляющих государственную тайну;
- Поставка специализированных компонентов (Xilinx, Altera, Analog Devices, Intersil, Interpoint, Microsemi, Aeroflex, Peregrine, Syfer, Eurofarad, Texas Instrument, Miteq, Cobham, E2V, MA-COM, Hittite, Mini-Circuits, General Dynamics и др.);

Помимо этого, одним из направлений компании «ЭлектроПласт» является направление «Источники питания». Мы предлагаем Вам помощь Конструкторского отдела:

- Подбор оптимального решения, техническое обоснование при выборе компонента;
- Подбор аналогов;
- Консультации по применению компонента;
- Поставка образцов и прототипов;
- Техническая поддержка проекта;
- Защита от снятия компонента с производства.



#### Как с нами связаться

**Телефон:** 8 (812) 309 58 32 (многоканальный)

**Факс:** 8 (812) 320-02-42

**Электронная почта:** [org@eplast1.ru](mailto:org@eplast1.ru)

**Адрес:** 198099, г. Санкт-Петербург, ул. Калинина, дом 2, корпус 4, литера А.