

POWER COMBICON

Feed-through headers with a 10.16 mm Pitch

DFK-PC(V) 6-16/...-G(F)(U)-(SH)-10,16

The DFK-PC 16 feed-through plug connector is an uncomplicated method of conducting a current of 76 A and a voltage of 600 V UL with a connection cross section of 16 mm² from inside the device to the outside and vice versa.

And this is how you make this seamless device connection: Just insert DFK-PC 16 into the opening in the housing and fix it in place using the easy-to-use snap-lock mechanism. The header version for direct soldering to the PCB is available with 2 to 9 positions and is suitable for the PC 6 plugs (with a current carrying capacity of 41 A) and the PC 16 plugs (current carrying capacity 76 A).

The versions with threaded flange "-GF/-GFU" have an integrated shroud, which carries the shielding function to the metal housing to comply with EMC regulations. If the housing of the device is not made of metal, it is possible with all "SH variants" to take the EMC shield function either directly onto the PCB or with a 6.3/2.8 x 0.8 mm slip-on connection to the next protection point.

It can be secured inside the housing using either the snap-lock mechanism or the conventional screw fixing. Both options are included with the product. If the screw option is chosen, screw set DFK-PC 16-SS should be used.

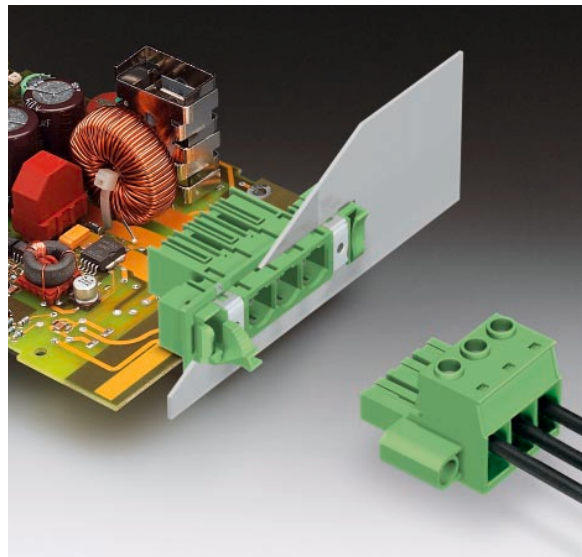

The COMBICON search engine with CAD downloading



COMBICON Select – the printed circuit board connection software supports your workflow from the PCB and housing layout to the ordering process with:

- Systematic and fast selection of products
- Universal Internet aided engineering with extensive CAD downloading
- Easy-to-use e-shopping functions.

select.phoenixcontact.com/combicon

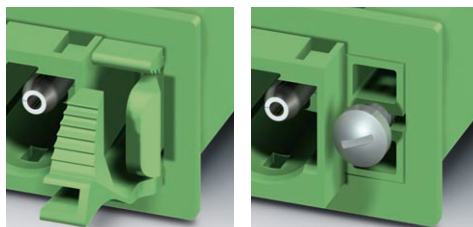



easy-to-use
snap-lock mechanism

screw fixing

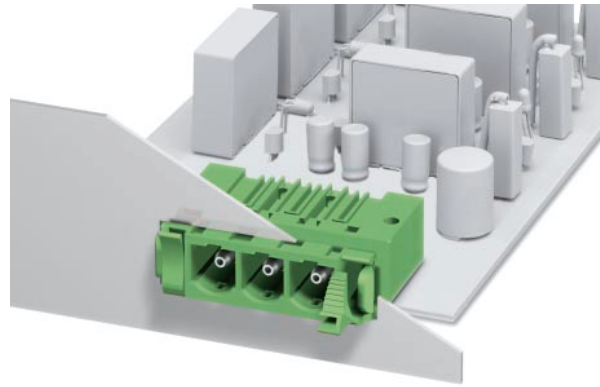
POWER COMBICON
Feed-through headers,
DFK-PC 6-16/...-G-10,16
10.16 mm pitch



Description	No. of pos.	Dim. a [mm]	Type	Order No.	Pcs./Pkt.
POWER COMBICON feed-through headers, pitch 10.16 mm, color: green, plug-in direction parallel to the PCB	2	10.16	DFK-PC 6-16/ 2-G-10,16	1701456	50
	3	20.32	DFK-PC 6-16/ 3-G-10,16	1701469	
	4	30.48	DFK-PC 6-16/ 4-G-10,16	1701472	
	5	40.64	DFK-PC 6-16/ 5-G-10,16	1701485	
	6	50.80	DFK-PC 6-16/ 6-G-10,16	1701498	
	7	60.96	DFK-PC 6-16/ 7-G-10,16	1701508	
	8	71.12	DFK-PC 6-16/ 8-G-10,16	1701511	
	9	81.28	DFK-PC 6-16/ 9-G-10,16	1701524	
	(1) Coding profile , is inserted into the groove on the plug and header, red insulating material 			CP-HCC 4	1600027
(2) Coding pin , serves to ensure correct polarization on the PCB during manual mounting 			CS-IPC 16/6	1970016	50
(3) Screw set for securing the header to the device wall, consisting of DIN ISO 70 49 screw ST 2,9 x 9,5, only necessary if the enclosed screw fixing is used			DFK-PC16-SS	1705449	20
(4) Screwdriver , a) to actuate the screw fixing b) facilitates actuating the snap-lock mechanism 			SZK PH 1 SZS 0,6 x 2,5	1205150 1205040	10 10
(5) Marker card , with 10 pcs. 10-section marker strips, white, self-adhesive, for 100 terminal blocks			SK 10/5 (see COMBICON catalog)		
Technical data			see description		
Dimensions		[mm]	10.16		
Pitch		[mm]	1.7		
Hole diameter		[mm]	0.8 x 1.2		
Pin dimensions		[mm]x[mm]			
Technical data in accordance with IEC/ DIN VDE					
Insulating material group		—	I		
Surge voltage category / contamination class		—/—	III / 3	III / 2	II / 2
Rated voltage		[V]	1000	1000	1000
Rated surge voltage		[kV]	8	8	6
Nominal current		[A]	41 ¹⁾ / 76 ¹⁾		
Maximum load current		[A]	41 ¹⁾ / 76 ¹⁾		
Insulating material			PA		
Inflammability class in acc. with UL 94			V0		
Approval data (UL/CUL and CSA)			applied for		
Nominal voltage / current / conductor sizes			UL/CUL: [V]/[A]/AWG CSA: [V]/[A]/AWG		

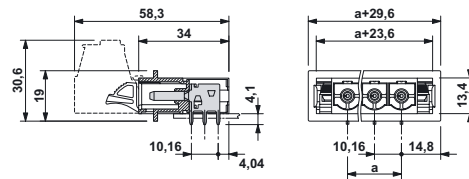
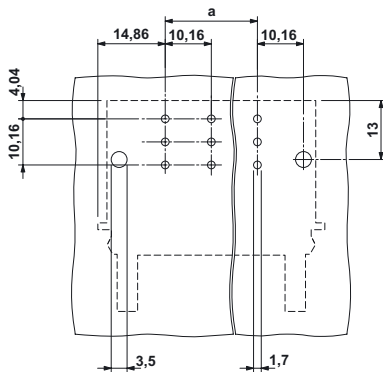

¹⁾ 41 A with PC 6/... plug, 76 A with PC 16/... plug
 Observe derating curve

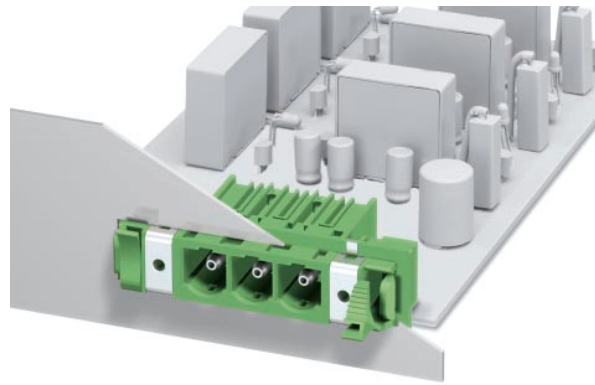

POWER COMBICON
Feed-through headers,
DFK-PC 6-16/...-GF-10,16,
10.16 mm pitch

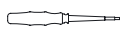

Description	No. of pos.	Dim. a [mm]
POWER COMBICON feed-through headers, pitch 10.16 mm, color: green, plug-in direction parallel to the PCB, with threaded flange and integrated shield connection to the housing of the device	2	10.16
	3	20.32
	4	30.48
	5	40.64
	6	50.80
	7	60.96
	8	71.12
	9	81.28

- (1) **Coding profile**, is inserted into the groove on the plug and header, red insulating material 
- (2) **Coding pin**, serves to ensure correct polarization on the PCB during manual mounting 
- (3) **Screw set** for securing the header to the device wall, consisting of DIN ISO 70 49 screw ST 2,9 x 9,5, only necessary if the enclosed screw fixing is used
- (4) **Screwdriver**,
 a) to actuate the screw fixing
 b) facilitates actuating the snap-lock mechanism 
- (5) **Marker card**, with 10 pcs. 10-section marker strips, white, self-adhesive, for 100 terminal blocks

Technical data

Dimensions		see description
Pitch	[mm]	10.16
Hole diameter	[mm]	1.7
Pin dimensions	[mm]x[mm]	0.8 x 1.2
Technical data in accordance with IEC/ DIN VDE		
Insulating material group	—	I
Surge voltage category / contamination class	—/—	III / 3 III / 2 II / 2
Rated voltage	[V]	1000 1000 1000
Rated surge voltage	[kV]	8 8 6
Nominal current	[A]	41 ¹⁾ / 76 ¹⁾
Maximum load current	[A]	41 ¹⁾ / 76 ¹⁾
Insulating material		
Inflammability class in acc. with UL 94		PA
Approval data (UL/CUL and CSA)		
Nominal voltage / current / conductor sizes	UL/CUL: [V]/[A]/AWG	applied for
	CSA: [V]/[A]/AWG	—

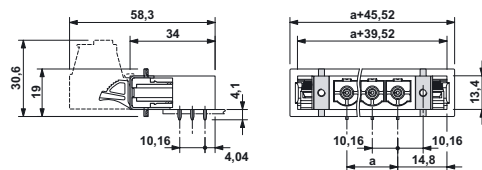
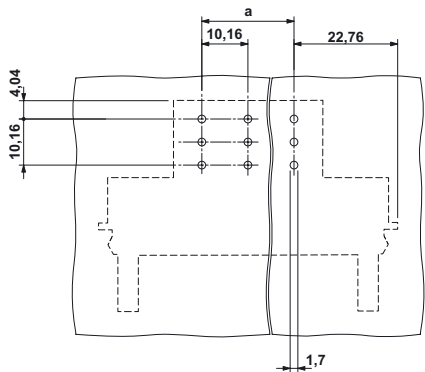

Type	Order No.	Pcs./Pkt.
DFK-PC 6-16/ 2-GF-10,16	1701537	50
DFK-PC 6-16/ 3-GF-10,16	1701540	
DFK-PC 6-16/ 4-GF-10,16	1701553	
DFK-PC 6-16/ 5-GF-10,16	1701566	
DFK-PC 6-16/ 6-GF-10,16	1701579	
DFK-PC 6-16/ 7-GF-10,16	1701582	
DFK-PC 6-16/ 8-GF-10,16	1701595	
DFK-PC 6-16/ 9-GF-10,16	1701605	
CP-HCC 4	1600027	
CS-IPC 16/6	1970016	50
DFK-PC16-SS	1705449	20
SZK PH 1	1205150	10
SZS 0,6 x 2,5	1205040	10
SK 10/5 (see COMBICON catalog)		

¹⁾ 41 A with PC 6/... plug, 76 A with PC 16/... plug
 Observe derating curve

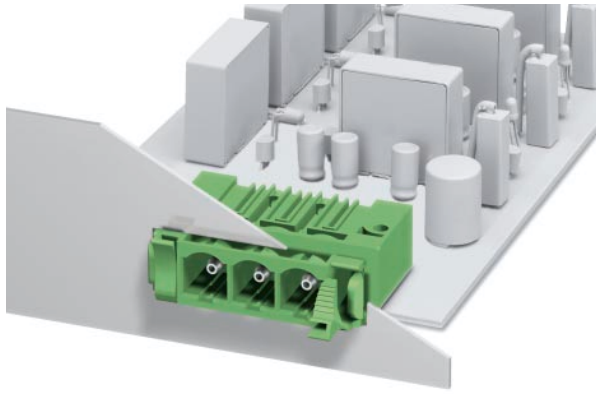

POWER COMBICON
Feed-through headers,
DFK-PC 6-16/...-GU-10,16
10.16 mm pitch



Description	No. of pos.	Dim. a [mm]	Type	Order No.	Pcs./Pkt.
POWER COMBICON feed-through headers, pitch 10.16 mm, color: green, plug-in direction parallel to the PCB, solder-in direction 180° reversed	2	10.16	DFK-PC 6-16/ 2-GU-10,16	1701618	50
	3	20.32	DFK-PC 6-16/ 3-GU-10,16	1701621	
	4	30.48	DFK-PC 6-16/ 4-GU-10,16	1701634	
	5	40.64	DFK-PC 6-16/ 5-GU-10,16	1701647	
	6	50.80	DFK-PC 6-16/ 6-GU-10,16	1701650	
	7	60.96	DFK-PC 6-16/ 7-GU-10,16	1701663	
	8	71.12	DFK-PC 6-16/ 8-GU-10,16	1701676	
	9	81.28	DFK-PC 6-16/ 9-GU-10,16	1701689	
	(1) Coding profile , is inserted into the groove on the plug and header, red insulating material 			CP-HCC 4	
(2) Coding pin , serves to ensure correct polarization on the PCB during manual mounting 			CS-IPC 16/6	1970016	50
(3) Screw set for securing the header to the device wall, consisting of DIN ISO 70 49 screw ST 2,9 x 9,5, only necessary if the enclosed screw fixing is used			DFK-PC16-SS	1705449	20
(4) Screwdriver , a) to actuate the screw fixing b) facilitates actuating the snap-lock mechanism 			SZK PH 1 SZS 0,6 x 2,5	1205150 1205040	10 10
(5) Marker card , with 10 pcs. 10-section marker strips, white, self-adhesive, for 100 terminal blocks			SK 10/5 (see COMBICON catalog)		
Technical data			see description		
Dimensions		[mm]	10.16		
Pitch		[mm]	1.7		
Hole diameter		[mm]	0.8 x 1.2		
Pin dimensions		[mm]x[mm]			
Technical data in accordance with IEC/ DIN VDE					
Insulating material group		—	I		
Surge voltage category / contamination class		—/—	III / 3	III / 2	II / 2
Rated voltage		[V]	1000	1000	1000
Rated surge voltage		[kV]	8	8	6
Nominal current		[A]	41 ¹⁾ / 76 ¹⁾		
Maximum load current		[A]	41 ¹⁾ / 76 ¹⁾		
Insulating material			PA		
Inflammability class in acc. with UL 94			V0		
Approval data (UL/CUL and CSA)			applied for		
Nominal voltage / current / conductor sizes			UL/CUL: [V]/[A]/AWG		
			CSA: [V]/[A]/AWG		

¹⁾ 41 A with PC 6/... plug, 76 A with PC 16/... plug
 Observe derating curve

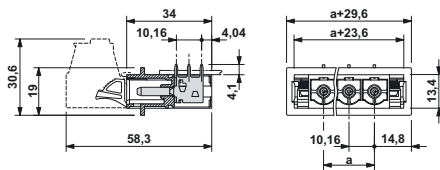
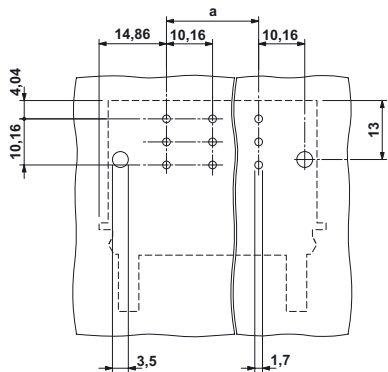



POWER COMBICON

Feed-through headers, DFK-PC 6-16/...-GFU-10,16

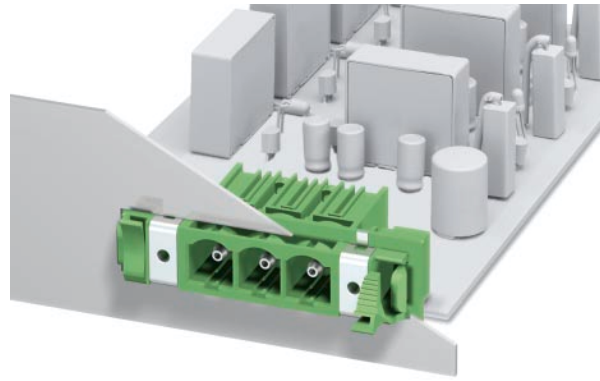
10.16 mm pitch



Description	No. of pos.	Dim. a [mm]	Type	Order No.	Pcs./Pkt.
POWER COMBICON feed-through headers, pitch 10.16 mm, color: green, solder-in direction 180° reversed, with threaded flange and integrated shield connection to the housing of the device, plug-in direction parallel to the PCB					
	2	10.16	DFK-PC 6-16/ 2-GFU-10,16	1701692	50
	3	20.32	DFK-PC 6-16/ 3-GFU-10,16	1701702	
	4	30.48	DFK-PC 6-16/ 4-GFU-10,16	1701715	
	5	40.64	DFK-PC 6-16/ 5-GFU-10,16	1701728	
	6	50.80	DFK-PC 6-16/ 6-GFU-10,16	1701731	
	7	60.96	DFK-PC 6-16/ 7-GFU-10,16	1701744	
	8	71.12	DFK-PC 6-16/ 8-GFU-10,16	1701757	
	9	81.28	DFK-PC 6-16/ 9-GFU-10,16	1701760	
(1) Coding profile , is inserted into the groove on the plug and header, red insulating material 			CP-HCC 4	1600027	50
(2) Coding pin , serves to ensure correct polarization on the PCB during manual mounting 			CS-IPC 16/6	1970016	50
(3) Screw set for securing the header to the device wall, consisting of DIN ISO 70 49 screw ST 2,9 x 9,5, only necessary if the enclosed screw fixing is used			DFK-PC16-SS	1705449	20
(4) Screwdriver , a) to actuate the screw fixing b) facilitates actuating the snap-lock mechanism 			SZK PH 1 SZS 0,6 x 2,5	1205150 1205040	10 10
(5) Marker card , with 10 pcs. 10-section marker strips, white, self-adhesive, for 100 terminal blocks			SK 10/5 (see COMBICON catalog)		
Technical data			see description		
Dimensions		[mm]	10.16		
Pitch		[mm]	1.7		
Hole diameter		[mm]	0.8 x 1.2		
Pin dimensions		[mm]x[mm]			
Technical data in accordance with IEC/ DIN VDE					
Insulating material group		—	I		
Surge voltage category / contamination class		—/—	III / 3	III / 2	II / 2
Rated voltage		[V]	1000	1000	1000
Rated surge voltage		[kV]	8	8	6
Nominal current		[A]	41 ¹⁾ / 76 ¹⁾		
Maximum load current		[A]	41 ¹⁾ / 76 ¹⁾		
Insulating material			PA		
Inflammability class in acc. with UL 94			V0		
Approval data (UL/CUL and CSA)			applied for		
Nominal voltage / current / conductor sizes			UL/CUL: [V]/[A]/AWG CSA: [V]/[A]/AWG		

¹⁾ 41 A with PC 6/... plug, 76 A with PC 16/... plug
Observe derating curve

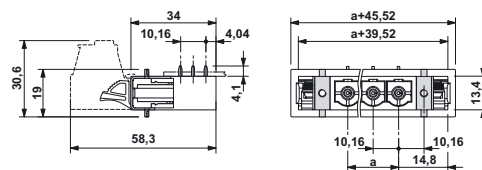
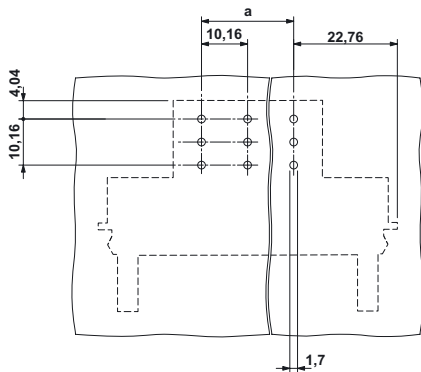

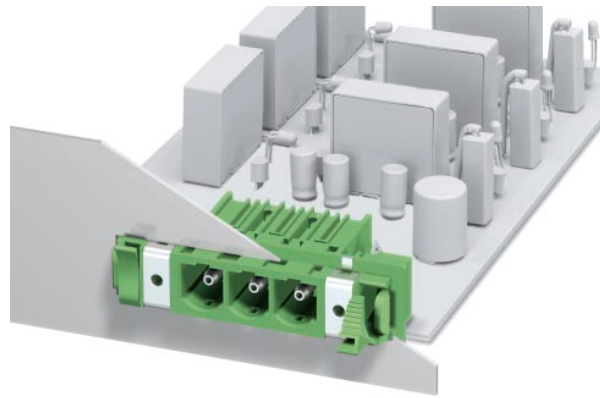

POWER COMBICON

Feed-through headers, DFK-PC 6-16-GF-SH-10,16 10.16 mm pitch



Description	No. of pos.	Dim. a [mm]
POWER COMBICON feed-through headers, pitch 10.16 mm, color: green, with threaded flange and integrated shield connection to the PCB, plug-in direction parallel to the PCB	2	10.16
	3	20.32
	4	30.48
	5	40.64
	6	50.80
	7	60.96
	8	71.12
	9	81.28

- (1) **Coding profile**, is inserted into the groove on the plug and header, red insulating material 
- (2) **Coding pin**, serves to ensure correct polarization on the PCB during manual mounting 
- (3) **Screw set** for securing the header to the device wall, consisting of DIN ISO 70 49 screw ST 2,9 x 9,5, only necessary if the enclosed screw fixing is used
- (4) **Screwdriver**,
a) to actuate the screw fixing
b) facilitates actuating the snap-lock mechanism 
- (5) **Marker card**, with 10 pcs. 10-section marker strips, white, self-adhesive, for 100 terminal blocks

Technical data

Dimensions		see description
Pitch	[mm]	10.16
Hole diameter	[mm]	1.7
Pin dimensions	[mm]x[mm]	0.8 x 1.2

Technical data in accordance with IEC/ DIN VDE

Insulating material group	—	I		
Surge voltage category / contamination class	—/—	III / 3	III / 2	II / 2
Rated voltage	[V]	1000	1000	1000
Rated surge voltage	[kV]	8	8	6
Nominal current	[A]		41 ¹⁾ / 76 ¹⁾	
Maximum load current	[A]		41 ¹⁾ / 76 ¹⁾	

Insulating material

Inflammability class in acc. with UL 94

Approval data (UL/CUL and CSA)

Nominal voltage / current / conductor sizes	UL/CUL: [V]/[A]/AWG			
	CSA: [V]/[A]/AWG			

Type	Order No.	Pcs./Pkt.
DFK-PC 6-16/2-GF-SH-10,16	1701935	50
DFK-PC 6-16/3-GF-SH-10,16	1701948	
DFK-PC 6-16/4-GF-SH-10,16	1701951	
DFK-PC 6-16/5-GF-SH-10,16	1701964	
DFK-PC 6-16/6-GF-SH-10,16	1701977	
DFK-PC 6-16/7-GF-SH-10,16	1701980	
DFK-PC 6-16/8-GF-SH-10,16	1701993	
DFK-PC 6-16/9-GF-SH-10,16	1702002	
CP-HCC 4	1600027	50
CS-IPC 16/6	1970016	50
DFK-PC16-SS	1705449	20
SZK PH 1	1205150	10
SZS 0,6 x 2,5	1205040	10
SK 10/5 (see COMBICON catalog)		

see description

10.16

1.7

0.8 x 1.2

III / 3

III / 2

II / 2

1000

1000

1000

8

8

6

41¹⁾ / 76¹⁾

41¹⁾ / 76¹⁾

PA

V0

applied for

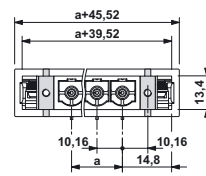
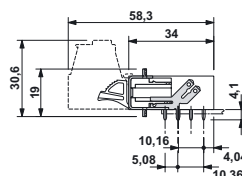
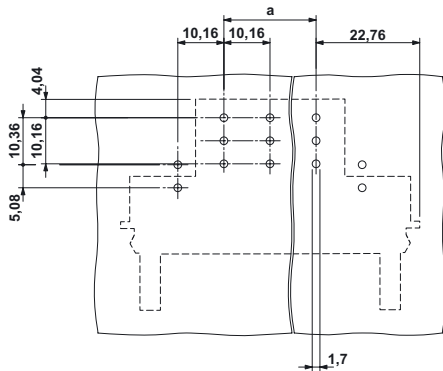

¹⁾ 41 A with PC 6/... plug, 76 A with PC 16/... plug
Observe derating curve

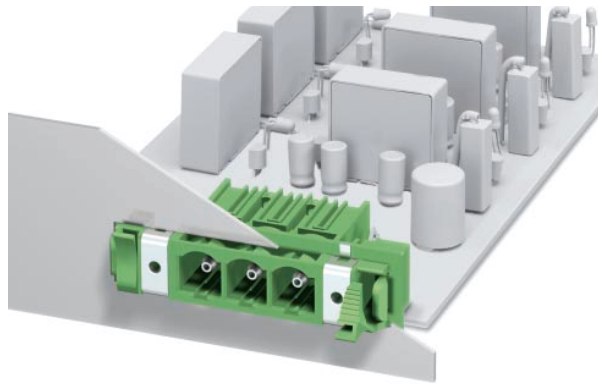

POWER COMBICON
Feed-through headers
DFK-PC 6-16/...-GFU-SH-10,16
10.16 mm pitch

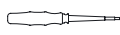

Description	No. of pos.	Dim. a [mm]
POWER COMBICON feed-through headers, pitch 10.16 mm, color: green,	2	10.16
solder-in direction 180° reversed, with threaded flange and integrated shield connection to the PCB, plug-in direction parallel to the PCB	3	20.32
	4	30.48
	5	40.64
	6	50.80
	7	60.96
	8	71.12
	9	81.28

- (1) **Coding profile**, is inserted into the groove on the plug and header, red insulating material 
- (2) **Coding pin**, serves to ensure correct polarization on the PCB during manual mounting 
- (3) **Screw set** for securing the header to the device wall, consisting of DIN ISO 70 49 screw ST 2,9 x 9,5, only necessary if the enclosed screw fixing is used
- (4) **Screwdriver**,
a) to actuate the screw fixing
b) facilitates actuating the snap-lock mechanism 
- (5) **Marker card**, with 10 pcs. 10-section marker strips, white, self-adhesive, for 100 terminal blocks

Technical data	
Dimensions	
Pitch	[mm] 10.16
Hole diameter	[mm] 1.7
Pin dimensions	[mm]x[mm] 0.8 x 1.2
Technical data in accordance with IEC/ DIN VDE	
Insulating material group	—
Surge voltage category / contamination class	—/—
Rated voltage	[V] 1000
Rated surge voltage	[kV] 8
Nominal current	[A] 41 ¹⁾ / 76 ¹⁾
Maximum load current	[A] 41 ¹⁾ / 76 ¹⁾
Insulating material	
Inflammability class in acc. with UL 94	PA
	V0
Approval data (UL/CUL and CSA)	
Nominal voltage / current / conductor sizes	UL/CUL: [V]/[A]/AWG CSA: [V]/[A]/AWG

Type	Order No.	Pcs./Pkt.
DFK-PC 6-16/2-GFU-SH-10,16	1702015	50
DFK-PC 6-16/3-GFU-SH-10,16	1702028	
DFK-PC 6-16/4-GFU-SH-10,16	1702031	
DFK-PC 6-16/5-GFU-SH-10,16	1702044	
DFK-PC 6-16/6-GFU-SH-10,16	1702057	
DFK-PC 6-16/7-GFU-SH-10,16	1702060	
DFK-PC 6-16/8-GFU-SH-10,16	1702073	
DFK-PC 6-16/9-GFU-SH-10,16	1702086	
CP-HCC 4	1600027	50
CS-IPC 16/6	1970016	50
DFK-PC16-SS	1705449	20
SZK PH 1	1205150	10
SZS 0,6 x 2,5	1205040	10
SK 10/5 (see COMBICON catalog)		

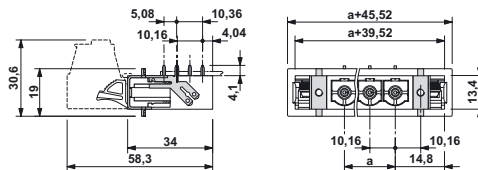
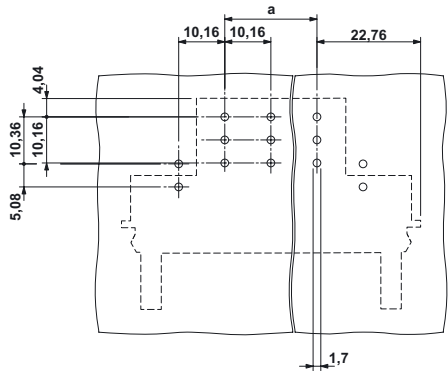

see description			
		I	
III / 3	III / 2	II / 2	
1000	1000	1000	
8	8	6	
	41 ¹⁾ / 76 ¹⁾		
	41 ¹⁾ / 76 ¹⁾		
	PA		
	V0		
applied for			

¹⁾ 41 A with PC 6/... plug, 76 A with PC 16/... plug
Observe derating curve

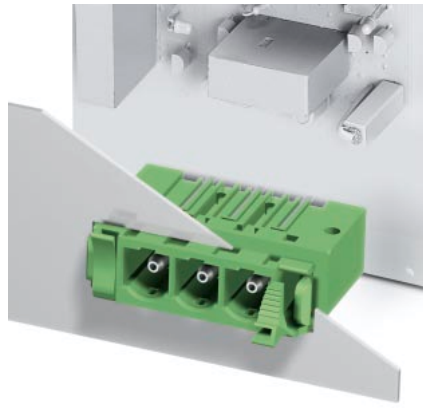

POWER COMBICON
Feed-through headers
DFK-PCV 6-16/...-G-10,16
10.16 mm pitch



Description	No. of pos.	Dim. a [mm]	Type	Order No.	Pcs./Pkt.
POWER COMBICON feed-through headers, pitch 10.16 mm, color: green, plug-in direction vertical to the PCB	2	10.16	DFK-PCV 6-16/ 2-G-10,16	1702099	50
	3	20.32	DFK-PCV 6-16/ 3-G-10,16	1702109	
	4	30.48	DFK-PCV 6-16/ 4-G-10,16	1702112	
	5	40.64	DFK-PCV 6-16/ 5-G-10,16	1702125	
	6	50.80	DFK-PCV 6-16/ 6-G-10,16	1702138	
	7	60.96	DFK-PCV 6-16/ 7-G-10,16	1702141	
	8	71.12	DFK-PCV 6-16/ 8-G-10,16	1702154	
	9	81.28	DFK-PCV 6-16/ 9-G-10,16	1702167	
	(1) Coding profile , is inserted into the groove on the plug and header, red insulating material			CP-HCC 4	1600027
(2) Coding pin , serves to ensure correct polarization on the PCB during manual mounting			CS-IPC 16/6	1970016	50
(3) Screw set for securing the header to the device wall, consisting of DIN ISO 70 49 screw ST 2,9 x 9,5, only necessary if the enclosed screw fixing is used			DFK-PC16-SS	1705449	20
(4) Screwdriver , a) to actuate the screw fixing b) facilitates actuating the snap-lock mechanism			SZK PH 1 SZS 0,6 x 2,5	1205150 1205040	10 10
(5) Marker card , with 10 pcs. 10-section marker strips, white, self-adhesive, for 100 terminal blocks			SK 10/5 (see COMBICON catalog)		
Technical data			see description		
Dimensions		[mm]	10.16		
Pitch		[mm]	1.7		
Hole diameter		[mm]	0.8 x 1.2		
Pin dimensions		[mm]x[mm]			
Technical data in accordance with IEC/ DIN VDE					
Insulating material group		—	I		
Surge voltage category / contamination class		—/—	III / 3	III / 2	II / 2
Rated voltage		[V]	1000	1000	1000
Rated surge voltage		[kV]	8	8	6
Nominal current		[A]	41 ¹⁾ / 76 ¹⁾		
Maximum load current		[A]	41 ¹⁾ / 76 ¹⁾		
Insulating material			PA		
Inflammability class in acc. with UL 94			V0		
Approval data (UL/CUL and CSA)			applied for		
Nominal voltage / current / conductor sizes			—		
UL/CUL: [V]/[A]/AWG					
CSA: [V]/[A]/AWG					

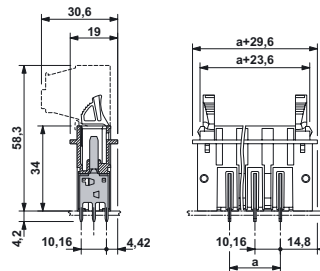
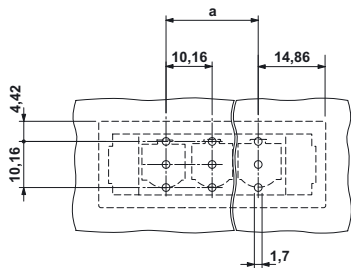

¹⁾ 41 A with PC 6/... plug, 76 A with PC 16/... plug
 Observe derating curve

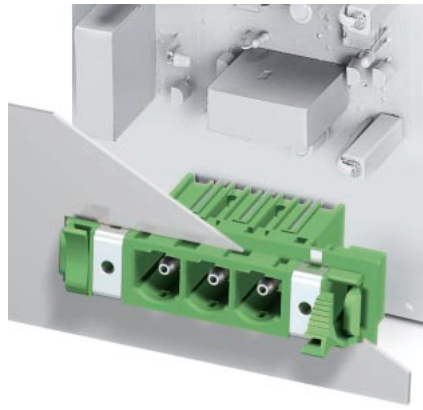

POWER COMBICON
Feed-through headers
DFK-PCV 6-16/...-GF-10,16
10.16 mm pitch



Description	No. of pos.	Dim. a [mm]
POWER COMBICON feed-through headers, pitch 10.16 mm, color: green,	2	10.16
plug-in direction vertical to the PCB,	3	20.32
with threaded flange and integrated shield	4	30.48
connection to the housing of the device	5	40.64
	6	50.80
	7	60.96
	8	71.12
	9	81.28

- (1) **Coding profile**, is inserted into the groove on the plug and header, red insulating material 
- (2) **Coding pin**, serves to ensure correct polarization on the PCB during manual mounting 
- (3) **Screw set** for securing the header to the device wall, consisting of DIN ISO 70 49 screw ST 2,9 x 9,5, only necessary if the enclosed screw fixing is used
- (4) **Screwdriver**,
a) to actuate the screw fixing
b) facilitates actuating the snap-lock mechanism 
- (5) **Marker card**, with 10 pcs. 10-section marker strips, white, self-adhesive, for 100 terminal blocks

Technical data

Dimensions		see description
Pitch	[mm]	10.16
Hole diameter	[mm]	1.7
Pin dimensions	[mm]x[mm]	0.8 x 1.2

Technical data in accordance with IEC/ DIN VDE

Insulating material group	—	I
Surge voltage category / contamination class	—/—	III / 3 III / 2 II / 2
Rated voltage	[V]	1000 1000 1000
Rated surge voltage	[kV]	8 8 6
Nominal current	[A]	41 ¹⁾ / 76 ¹⁾
Maximum load current	[A]	41 ¹⁾ / 76 ¹⁾

Insulating material

Inflammability class in acc. with UL 94

Approval data (UL/CUL and CSA)

Nominal voltage / current / conductor sizes	UL/CUL: [V]/[A]/AWG	applied for
	CSA: [V]/[A]/AWG	—

Type	Order No.	Pcs./Pkt.
DFK-PCV 6-16/ 2-GF-10,16	1702251	50
DFK-PCV 6-16/ 3-GF-10,16	1702264	
DFK-PCV 6-16/ 4-GF-10,16	1702277	
DFK-PCV 6-16/ 5-GF-10,16	1702280	
DFK-PCV 6-16/ 6-GF-10,16	1702293	
DFK-PCV 6-16/ 7-GF-10,16	1702303	
DFK-PCV 6-16/ 8-GF-10,16	1702316	
DFK-PCV 6-16/ 9-GF-10,16	1702329	
CP-HCC 4	1600027	50
CS-IPC 16/6	1970016	50
DFK-PC16-SS	1705449	20
SZK PH 1	1205150	10
SZS 0,6 x 2,5	1205040	10
SK 10/5 (see COMBICON catalog)		

¹⁾ 41 A with PC 6/... plug, 76 A with PC 16/... plug
Observe derating curve

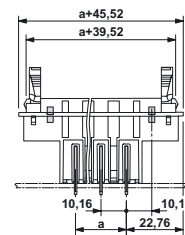
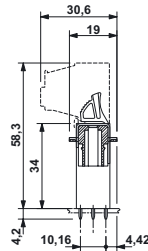
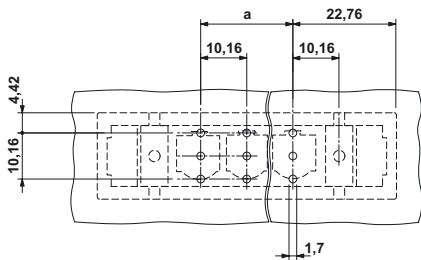

Sheet metal cutout for snap-on

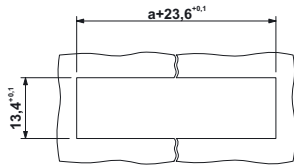

"-G-" and "-GU-" versions

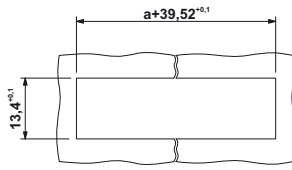

"-GF-" and "-GFU-" versions

Sheet metal cutout for screw connection

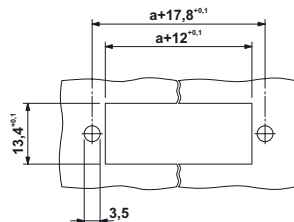

"-G-" and "-GU-" versions

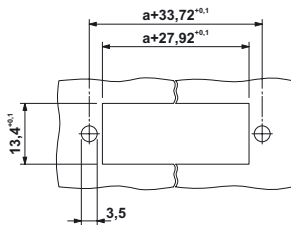

"-GF-" and "-GFU-" versions

Plug: DFK-PC(V) 6-16/...-G(F)(U)-(SH)-10,16
 Header: PC 16/...-ST(F)-(SH)-10,16
 Conductor cross section 16 mm²

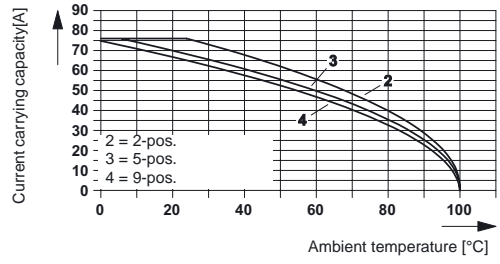



Компания «ЭлектроПласт» предлагает заключение долгосрочных отношений при поставках импортных электронных компонентов на взаимовыгодных условиях!

Наши преимущества:

- Оперативные поставки широкого спектра электронных компонентов отечественного и импортного производства напрямую от производителей и с крупнейших мировых складов;
- Поставка более 17-ти миллионов наименований электронных компонентов;
- Поставка сложных, дефицитных, либо снятых с производства позиций;
- Оперативные сроки поставки под заказ (от 5 рабочих дней);
- Экспресс доставка в любую точку России;
- Техническая поддержка проекта, помощь в подборе аналогов, поставка прототипов;
- Система менеджмента качества сертифицирована по Международному стандарту ISO 9001;
- Лицензия ФСБ на осуществление работ с использованием сведений, составляющих государственную тайну;
- Поставка специализированных компонентов (Xilinx, Altera, Analog Devices, Intersil, Interpoint, Microsemi, Aeroflex, Peregrine, Syfer, Eurofarad, Texas Instrument, Miteq, Cobham, E2V, MA-COM, Hittite, Mini-Circuits, General Dynamics и др.);

Помимо этого, одним из направлений компании «ЭлектроПласт» является направление «Источники питания». Мы предлагаем Вам помощь Конструкторского отдела:

- Подбор оптимального решения, техническое обоснование при выборе компонента;
- Подбор аналогов;
- Консультации по применению компонента;
- Поставка образцов и прототипов;
- Техническая поддержка проекта;
- Защита от снятия компонента с производства.



Как с нами связаться

Телефон: 8 (812) 309 58 32 (многоканальный)

Факс: 8 (812) 320-02-42

Электронная почта: org@eplast1.ru

Адрес: 198099, г. Санкт-Петербург, ул. Калинина, дом 2, корпус 4, литера А.