

# POWER COMBICON

## Feed-through headers with a 10.16 mm Pitch

### DFK-PC(V) 6-16/...-G(F)(U)-(SH)-10,16

---

The DFK-PC 16 feed-through plug connector is an uncomplicated method of conducting a current of 76 A and a voltage of 600 V UL with a connection cross section of 16 mm<sup>2</sup> from inside the device to the outside and vice versa.

And this is how you make this seamless device connection: Just insert DFK-PC 16 into the opening in the housing and fix it in place using the easy-to-use snap-lock mechanism. The header version for direct soldering to the PCB is available with 2 to 9 positions and is suitable for the PC 6 plugs (with a current carrying capacity of 41 A) and the PC 16 plugs (current carrying capacity 76 A).

The versions with threaded flange "-GF/-GFU" have an integrated shroud, which carries the shielding function to the metal housing to comply with EMC regulations. If the housing of the device is not made of metal, it is possible with all "SH variants" to take the EMC shield function either directly onto the PCB or with a 6.3/2.8 x 0.8 mm slip-on connection to the next protection point.

It can be secured inside the housing using either the snap-lock mechanism or the conventional screw fixing. Both options are included with the product. If the screw option is chosen, screw set DFK-PC 16-SS should be used.

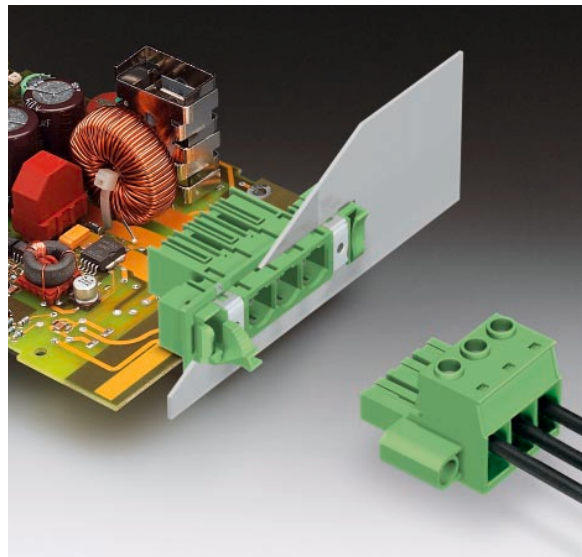

The COMBICON search engine with CAD downloading



COMBICON Select – the printed circuit board connection software supports your workflow from the PCB and housing layout to the ordering process with:

- Systematic and fast selection of products
- Universal Internet aided engineering with extensive CAD downloading
- Easy-to-use e-shopping functions.

[select.phoenixcontact.com/combicon](http://select.phoenixcontact.com/combicon)

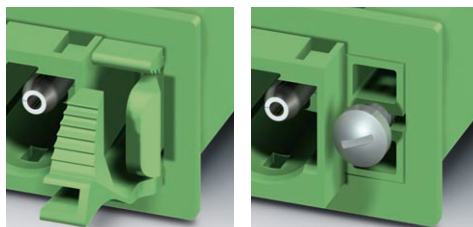



easy-to-use  
snap-lock mechanism

screw fixing

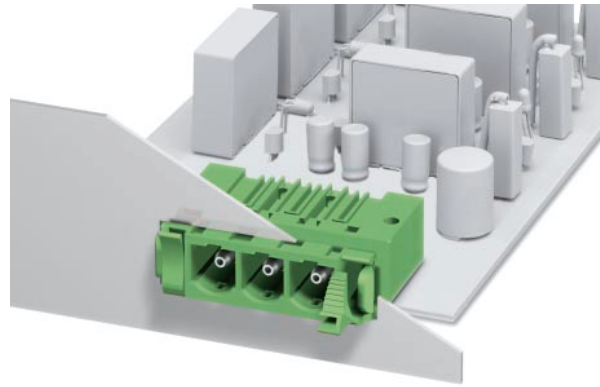
**POWER COMBICON**  
**Feed-through headers,**  
**DFK-PC 6-16/...-G-10,16**  
**10.16 mm pitch**



Description	No. of pos.	Dim. a [mm]	Type	Order No.	Pcs./Pkt.
<b>POWER COMBICON feed-through headers, pitch 10.16 mm, color: green, plug-in direction parallel to the PCB</b>					
	2	10.16	<b>DFK-PC 6-16/ 2-G-10,16</b>	<b>1701456</b>	50
	3	20.32	<b>DFK-PC 6-16/ 3-G-10,16</b>	<b>1701469</b>	
	4	30.48	<b>DFK-PC 6-16/ 4-G-10,16</b>	<b>1701472</b>	
	5	40.64	<b>DFK-PC 6-16/ 5-G-10,16</b>	<b>1701485</b>	
	6	50.80	<b>DFK-PC 6-16/ 6-G-10,16</b>	<b>1701498</b>	
	7	60.96	<b>DFK-PC 6-16/ 7-G-10,16</b>	<b>1701508</b>	
	8	71.12	<b>DFK-PC 6-16/ 8-G-10,16</b>	<b>1701511</b>	
	9	81.28	<b>DFK-PC 6-16/ 9-G-10,16</b>	<b>1701524</b>	
(1) <b>Coding profile</b> , is inserted into the groove on the plug and header, red insulating material			<b>CP-HCC 4</b>	<b>1600027</b>	50
(2) <b>Coding pin</b> , serves to ensure correct polarization on the PCB during manual mounting			<b>CS-IPC 16/6</b>	<b>1970016</b>	50
(3) <b>Screw set</b> for securing the header to the device wall, consisting of DIN ISO 70 49 screw ST 2,9 x 9,5, only necessary if the enclosed screw fixing is used			<b>DFK-PC16-SS</b>	<b>1705449</b>	20
(4) <b>Screwdriver</b> , a) to actuate the screw fixing b) facilitates actuating the snap-lock mechanism			<b>SZK PH 1</b> <b>SZS 0,6 x 2,5</b>	<b>1205150</b> <b>1205040</b>	10 10
(5) <b>Marker card</b> , with 10 pcs. 10-section marker strips, white, self-adhesive, for 100 terminal blocks			<b>SK 10/5</b> (see COMBICON catalog)		
<b>Technical data</b>			see description		
Dimensions		[mm]	10.16		
Pitch		[mm]	1.7		
Hole diameter		[mm]	0.8 x 1.2		
Pin dimensions		[mm]x[mm]			
<b>Technical data in accordance with IEC/ DIN VDE</b>					
Insulating material group		—	I		
Surge voltage category / contamination class		—/—	III / 3	III / 2	II / 2
Rated voltage		[V]	1000	1000	1000
Rated surge voltage		[kV]	8	8	6
Nominal current		[A]		41 <sup>1)</sup> / 76 <sup>1)</sup>	
Maximum load current		[A]		41 <sup>1)</sup> / 76 <sup>1)</sup>	
<b>Insulating material</b>					
Inflammability class in acc. with UL 94			PA		
<b>Approval data (UL/CUL and CSA)</b>					
Nominal voltage / current / conductor sizes		UL/CUL: [V]/[A]/AWG	applied for		
		CSA: [V]/[A]/AWG	—		

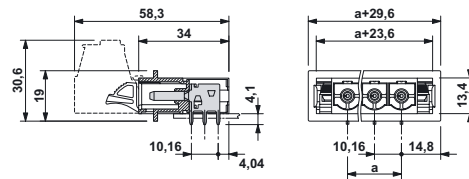
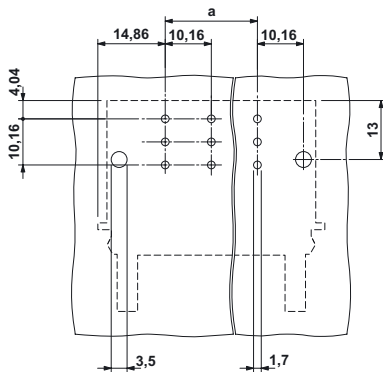

<sup>1)</sup> 41 A with PC 6/... plug, 76 A with PC 16/... plug  
 Observe derating curve

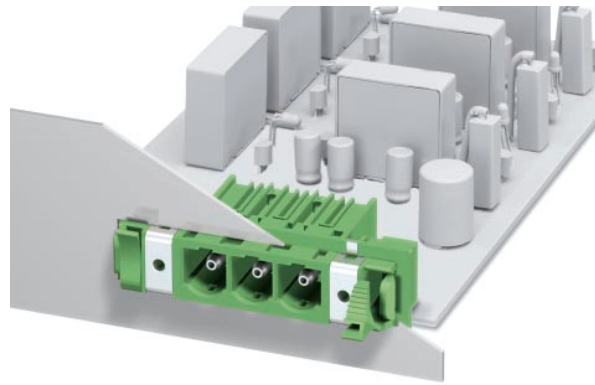

**POWER COMBICON**  
**Feed-through headers,**  
**DFK-PC 6-16/...-GF-10,16,**  
**10.16 mm pitch**

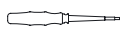

Description	No. of pos.	Dim. a [mm]
<b>POWER COMBICON feed-through headers, pitch 10.16 mm, color: green,</b> plug-in direction parallel to the PCB, with threaded flange and integrated shield connection to the housing of the device	2	10.16
	3	20.32
	4	30.48
	5	40.64
	6	50.80
	7	60.96
	8	71.12
	9	81.28

- (1) **Coding profile**, is inserted into the groove on the plug and header, red insulating material 
- (2) **Coding pin**, serves to ensure correct polarization on the PCB during manual mounting 
- (3) **Screw set** for securing the header to the device wall, consisting of DIN ISO 70 49 screw ST 2,9 x 9,5, only necessary if the enclosed screw fixing is used
- (4) **Screwdriver**,  
 a) to actuate the screw fixing  
 b) facilitates actuating the snap-lock mechanism 
- (5) **Marker card**, with 10 pcs. 10-section marker strips, white, self-adhesive, for 100 terminal blocks

Technical data	
Dimensions	see description
Pitch	[mm] 10.16
Hole diameter	[mm] 1.7
Pin dimensions	[mm]x[mm] 0.8 x 1.2
Technical data in accordance with IEC/ DIN VDE	
Insulating material group	—
Surge voltage category / contamination class	—/—
Rated voltage	[V] 1000
Rated surge voltage	[kV] 8
Nominal current	[A] 41 <sup>1)</sup> / 76 <sup>1)</sup>
Maximum load current	[A] 41 <sup>1)</sup> / 76 <sup>1)</sup>
Insulating material	
Inflammability class in acc. with UL 94	PA
<b>Approval data (UL/CUL and CSA)</b>	
Nominal voltage / current / conductor sizes	UL/CUL: [V]/[A]/AWG — CSA: [V]/[A]/AWG —

Type	Order No.	Pcs./Pkt.
<b>DFK-PC 6-16/ 2-GF-10,16</b>	<b>1701537</b>	50
<b>DFK-PC 6-16/ 3-GF-10,16</b>	<b>1701540</b>	
<b>DFK-PC 6-16/ 4-GF-10,16</b>	<b>1701553</b>	
<b>DFK-PC 6-16/ 5-GF-10,16</b>	<b>1701566</b>	
<b>DFK-PC 6-16/ 6-GF-10,16</b>	<b>1701579</b>	
<b>DFK-PC 6-16/ 7-GF-10,16</b>	<b>1701582</b>	
<b>DFK-PC 6-16/ 8-GF-10,16</b>	<b>1701595</b>	
<b>DFK-PC 6-16/ 9-GF-10,16</b>	<b>1701605</b>	
<b>CP-HCC 4</b>	<b>1600027</b>	50
<b>CS-IPC 16/6</b>	<b>1970016</b>	50
<b>DFK-PC16-SS</b>	<b>1705449</b>	20
<b>SZK PH 1</b>	<b>1205150</b>	10
<b>SZS 0,6 x 2,5</b>	<b>1205040</b>	10
<b>SK 10/5</b> (see COMBICON catalog)		

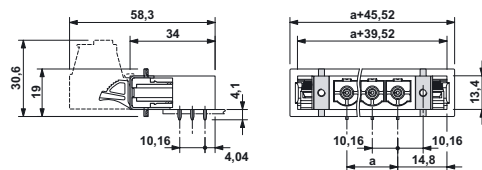
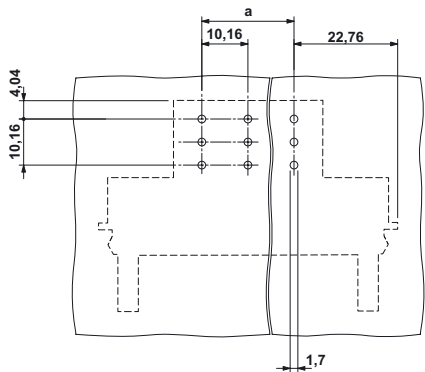

see description			
		I	
III / 3	III / 2	II / 2	
1000	1000	1000	
8	8	6	
	41 <sup>1)</sup> / 76 <sup>1)</sup>		
	41 <sup>1)</sup> / 76 <sup>1)</sup>		
	PA		
	V0		
applied for			

<sup>1)</sup> 41 A with PC 6/... plug, 76 A with PC 16/... plug  
 Observe derating curve

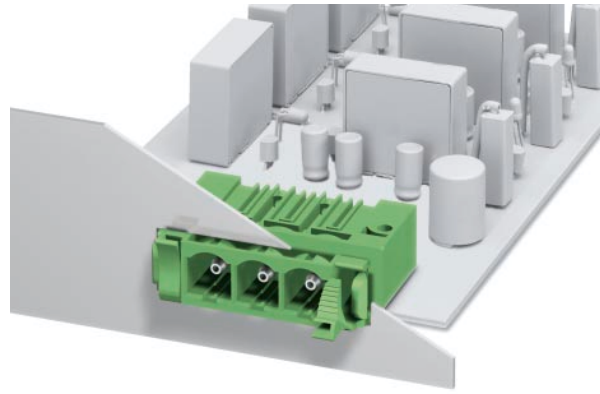

**POWER COMBICON**  
**Feed-through headers,**  
**DFK-PC 6-16/...-GU-10,16**  
**10.16 mm pitch**



Description	No. of pos.	Dim. a [mm]	Type	Order No.	Pcs./Pkt.
<b>POWER COMBICON feed-through headers, pitch 10.16 mm, color: green,</b> plug-in direction parallel to the PCB, solder-in direction 180° reversed	2	10.16	<b>DFK-PC 6-16/ 2-GU-10,16</b>	<b>1701618</b>	50
	3	20.32	<b>DFK-PC 6-16/ 3-GU-10,16</b>	<b>1701621</b>	
	4	30.48	<b>DFK-PC 6-16/ 4-GU-10,16</b>	<b>1701634</b>	
	5	40.64	<b>DFK-PC 6-16/ 5-GU-10,16</b>	<b>1701647</b>	
	6	50.80	<b>DFK-PC 6-16/ 6-GU-10,16</b>	<b>1701650</b>	
	7	60.96	<b>DFK-PC 6-16/ 7-GU-10,16</b>	<b>1701663</b>	
	8	71.12	<b>DFK-PC 6-16/ 8-GU-10,16</b>	<b>1701676</b>	
	9	81.28	<b>DFK-PC 6-16/ 9-GU-10,16</b>	<b>1701689</b>	
	(1) <b>Coding profile</b> , is inserted into the groove on the plug and header, red insulating material 			<b>CP-HCC 4</b>	
(2) <b>Coding pin</b> , serves to ensure correct polarization on the PCB during manual mounting 			<b>CS-IPC 16/6</b>	<b>1970016</b>	50
(3) <b>Screw set</b> for securing the header to the device wall, consisting of DIN ISO 70 49 screw ST 2,9 x 9,5, only necessary if the enclosed screw fixing is used			<b>DFK-PC16-SS</b>	<b>1705449</b>	20
(4) <b>Screwdriver</b> , a) to actuate the screw fixing b) facilitates actuating the snap-lock mechanism 			<b>SZK PH 1</b> <b>SZS 0,6 x 2,5</b>	<b>1205150</b> <b>1205040</b>	10 10
(5) <b>Marker card</b> , with 10 pcs. 10-section marker strips, white, self-adhesive, for 100 terminal blocks			<b>SK 10/5</b> (see COMBICON catalog)		
<b>Technical data</b>			see description		
Dimensions		[mm]	10.16		
Pitch		[mm]	1.7		
Hole diameter		[mm]	0.8 x 1.2		
Pin dimensions		[mm]x[mm]			
<b>Technical data in accordance with IEC/ DIN VDE</b>					
Insulating material group		—	I		
Surge voltage category / contamination class		—/—	III / 3	III / 2	II / 2
Rated voltage		[V]	1000	1000	1000
Rated surge voltage		[kV]	8	8	6
Nominal current		[A]	41 <sup>1)</sup> / 76 <sup>1)</sup>		
Maximum load current		[A]	41 <sup>1)</sup> / 76 <sup>1)</sup>		
<b>Insulating material</b>			PA		
Inflammability class in acc. with UL 94			V0		
<b>Approval data (UL/CUL and CSA)</b>			applied for		
Nominal voltage / current / conductor sizes			UL/CUL: [V]/[A]/AWG		
			CSA: [V]/[A]/AWG		

<sup>1)</sup> 41 A with PC 6/... plug, 76 A with PC 16/... plug  
 Observe derating curve

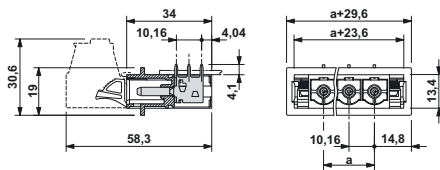
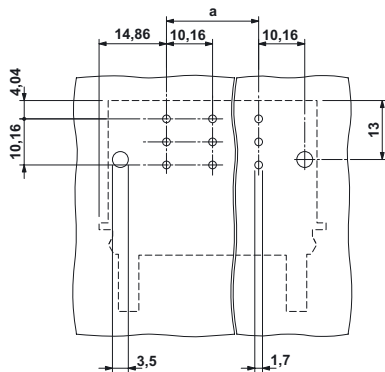



# POWER COMBICON

## Feed-through headers, DFK-PC 6-16/...-GFU-10,16

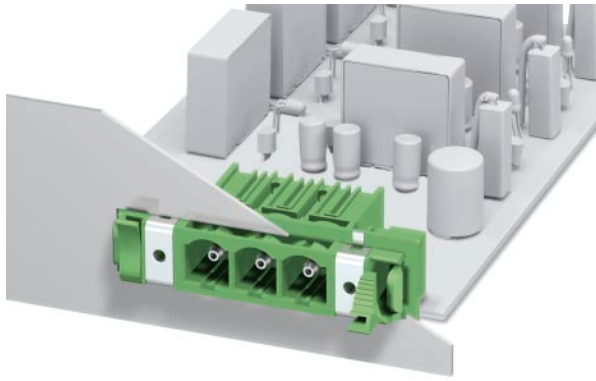
### 10.16 mm pitch

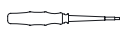

Description	No. of pos.	Dim. a [mm]
<b>POWER COMBICON feed-through headers, pitch 10.16 mm, color: green,</b>	2	10.16
solder-in direction 180° reversed, with threaded flange and integrated shield connection to the housing of the device, plug-in direction parallel to the PCB	3	20.32
	4	30.48
	5	40.64
	6	50.80
	7	60.96
	8	71.12
	9	81.28

- (1) **Coding profile**, is inserted into the groove on the plug and header, red insulating material 
- (2) **Coding pin**, serves to ensure correct polarization on the PCB during manual mounting 
- (3) **Screw set** for securing the header to the device wall, consisting of DIN ISO 70 49 screw ST 2,9 x 9,5, only necessary if the enclosed screw fixing is used
- (4) **Screwdriver**,  
a) to actuate the screw fixing  
b) facilitates actuating the snap-lock mechanism 
- (5) **Marker card**, with 10 pcs. 10-section marker strips, white, self-adhesive, for 100 terminal blocks

#### Technical data

Dimensions		see description
Pitch	[mm]	10.16
Hole diameter	[mm]	1.7
Pin dimensions	[mm]x[mm]	0.8 x 1.2

#### Technical data in accordance with IEC/ DIN VDE

Insulating material group	—	I		
Surge voltage category / contamination class	—/—	III / 3	III / 2	II / 2
Rated voltage	[V]	1000	1000	1000
Rated surge voltage	[kV]	8	8	6
Nominal current	[A]		41 <sup>1)</sup> / 76 <sup>1)</sup>	
Maximum load current	[A]		41 <sup>1)</sup> / 76 <sup>1)</sup>	

#### Insulating material

Inflammability class in acc. with UL 94

#### Approval data (UL/CUL and CSA)

Nominal voltage / current / conductor sizes	UL/CUL: [V]/[A]/AWG	applied for
	CSA: [V]/[A]/AWG	—

Type	Order No.	Pcs./Pkt.
<b>DFK-PC 6-16/ 2-GFU-10,16</b>	<b>1701692</b>	50
<b>DFK-PC 6-16/ 3-GFU-10,16</b>	<b>1701702</b>	
<b>DFK-PC 6-16/ 4-GFU-10,16</b>	<b>1701715</b>	
<b>DFK-PC 6-16/ 5-GFU-10,16</b>	<b>1701728</b>	
<b>DFK-PC 6-16/ 6-GFU-10,16</b>	<b>1701731</b>	
<b>DFK-PC 6-16/ 7-GFU-10,16</b>	<b>1701744</b>	
<b>DFK-PC 6-16/ 8-GFU-10,16</b>	<b>1701757</b>	
<b>DFK-PC 6-16/ 9-GFU-10,16</b>	<b>1701760</b>	
<b>CP-HCC 4</b>	<b>1600027</b>	50
<b>CS-IPC 16/6</b>	<b>1970016</b>	50
<b>DFK-PC16-SS</b>	<b>1705449</b>	20
<b>SZK PH 1</b>	<b>1205150</b>	10
<b>SZS 0,6 x 2,5</b>	<b>1205040</b>	10
<b>SK 10/5</b> (see COMBICON catalog)		

<sup>1)</sup> 41 A with PC 6/... plug, 76 A with PC 16/... plug  
Observe derating curve

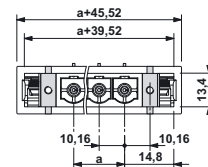
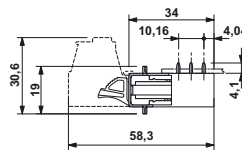
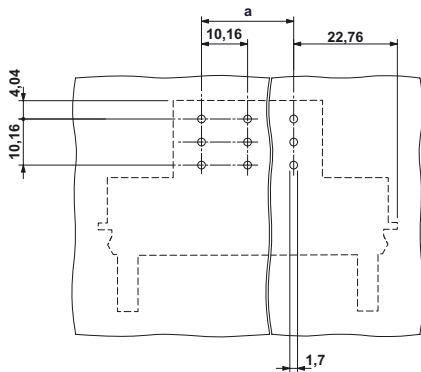

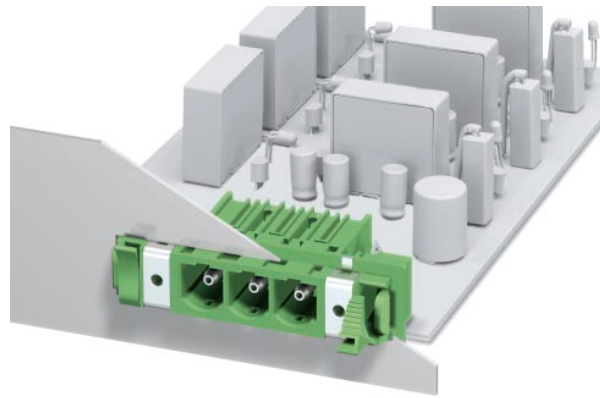

# POWER COMBICON

## Feed-through headers, DFK-PC 6-16-GF-SH-10,16 10.16 mm pitch



Description	No. of pos.	Dim. a [mm]
<b>POWER COMBICON feed-through headers, pitch 10.16 mm, color: green, with threaded flange and integrated shield connection to the PCB, plug-in direction parallel to the PCB</b>	2	10.16
	3	20.32
	4	30.48
	5	40.64
	6	50.80
	7	60.96
	8	71.12
	9	81.28

- (1) **Coding profile**, is inserted into the groove on the plug and header, red insulating material 
- (2) **Coding pin**, serves to ensure correct polarization on the PCB during manual mounting 
- (3) **Screw set** for securing the header to the device wall, consisting of DIN ISO 70 49 screw ST 2,9 x 9,5, only necessary if the enclosed screw fixing is used
- (4) **Screwdriver**,  
a) to actuate the screw fixing  
b) facilitates actuating the snap-lock mechanism 
- (5) **Marker card**, with 10 pcs. 10-section marker strips, white, self-adhesive, for 100 terminal blocks

### Technical data

Dimensions		see description
Pitch	[mm]	10.16
Hole diameter	[mm]	1.7
Pin dimensions	[mm]x[mm]	0.8 x 1.2

### Technical data in accordance with IEC/ DIN VDE

Insulating material group	—	I		
Surge voltage category / contamination class	—/—	III / 3	III / 2	II / 2
Rated voltage	[V]	1000	1000	1000
Rated surge voltage	[kV]	8	8	6
Nominal current	[A]		41 <sup>1)</sup> / 76 <sup>1)</sup>	
Maximum load current	[A]		41 <sup>1)</sup> / 76 <sup>1)</sup>	

### Insulating material

Inflammability class in acc. with UL 94

### Approval data (UL/CUL and CSA)

Nominal voltage / current / conductor sizes	UL/CUL: [V]/[A]/AWG	applied for
	CSA: [V]/[A]/AWG	—

Type	Order No.	Pcs./Pkt.
<b>DFK-PC 6-16/2-GF-SH-10,16</b>	<b>1701935</b>	50
<b>DFK-PC 6-16/3-GF-SH-10,16</b>	<b>1701948</b>	
<b>DFK-PC 6-16/4-GF-SH-10,16</b>	<b>1701951</b>	
<b>DFK-PC 6-16/5-GF-SH-10,16</b>	<b>1701964</b>	
<b>DFK-PC 6-16/6-GF-SH-10,16</b>	<b>1701977</b>	
<b>DFK-PC 6-16/7-GF-SH-10,16</b>	<b>1701980</b>	
<b>DFK-PC 6-16/8-GF-SH-10,16</b>	<b>1701993</b>	
<b>DFK-PC 6-16/9-GF-SH-10,16</b>	<b>1702002</b>	
<b>CP-HCC 4</b>	<b>1600027</b>	50
<b>CS-IPC 16/6</b>	<b>1970016</b>	50
<b>DFK-PC16-SS</b>	<b>1705449</b>	20
<b>SZK PH 1</b>	<b>1205150</b>	10
<b>SZS 0,6 x 2,5</b>	<b>1205040</b>	10
<b>SK 10/5</b> (see COMBICON catalog)		

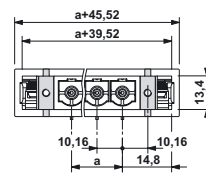
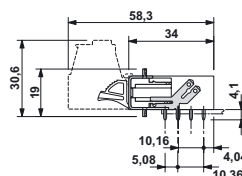
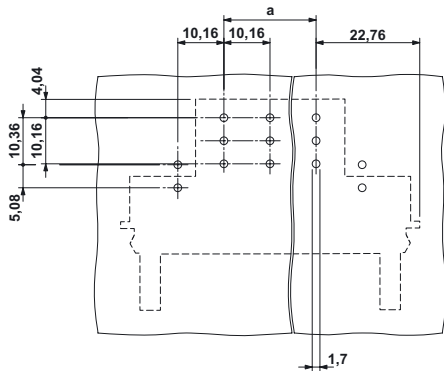

<sup>1)</sup> 41 A with PC 6/... plug, 76 A with PC 16/... plug  
Observe derating curve

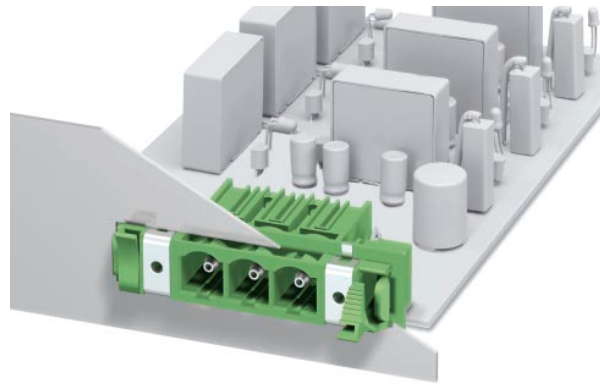

**POWER COMBICON**  
**Feed-through headers**  
**DFK-PC 6-16/...-GFU-SH-10,16**  
**10.16 mm pitch**

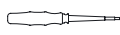

Description	No. of pos.	Dim. a [mm]
<b>POWER COMBICON feed-through headers, pitch 10.16 mm, color: green,</b>	2	10.16
solder-in direction 180° reversed, with threaded flange and integrated shield connection to the PCB, plug-in direction parallel to the PCB	3	20.32
	4	30.48
	5	40.64
	6	50.80
	7	60.96
	8	71.12
	9	81.28

- (1) **Coding profile**, is inserted into the groove on the plug and header, red insulating material 
- (2) **Coding pin**, serves to ensure correct polarization on the PCB during manual mounting 
- (3) **Screw set** for securing the header to the device wall, consisting of DIN ISO 70 49 screw ST 2,9 x 9,5, only necessary if the enclosed screw fixing is used
- (4) **Screwdriver**,  
a) to actuate the screw fixing  
b) facilitates actuating the snap-lock mechanism 
- (5) **Marker card**, with 10 pcs. 10-section marker strips, white, self-adhesive, for 100 terminal blocks

Technical data	
Dimensions	
Pitch	[mm] 10.16
Hole diameter	[mm] 1.7
Pin dimensions	[mm]x[mm] 0.8 x 1.2
Technical data in accordance with IEC/ DIN VDE	
Insulating material group	—
Surge voltage category / contamination class	—/—
Rated voltage	[V] 1000
Rated surge voltage	[kV] 8
Nominal current	[A] 41 <sup>1)</sup> / 76 <sup>1)</sup>
Maximum load current	[A] 41 <sup>1)</sup> / 76 <sup>1)</sup>
Insulating material	
Inflammability class in acc. with UL 94	PA
	V0
Approval data (UL/CUL and CSA)	
Nominal voltage / current / conductor sizes	UL/CUL: [V]/[A]/AWG CSA: [V]/[A]/AWG

Type	Order No.	Pcs./Pkt.
<b>DFK-PC 6-16/2-GFU-SH-10,16</b>	<b>1702015</b>	50
<b>DFK-PC 6-16/3-GFU-SH-10,16</b>	<b>1702028</b>	
<b>DFK-PC 6-16/4-GFU-SH-10,16</b>	<b>1702031</b>	
<b>DFK-PC 6-16/5-GFU-SH-10,16</b>	<b>1702044</b>	
<b>DFK-PC 6-16/6-GFU-SH-10,16</b>	<b>1702057</b>	
<b>DFK-PC 6-16/7-GFU-SH-10,16</b>	<b>1702060</b>	
<b>DFK-PC 6-16/8-GFU-SH-10,16</b>	<b>1702073</b>	
<b>DFK-PC 6-16/9-GFU-SH-10,16</b>	<b>1702086</b>	
<b>CP-HCC 4</b>	<b>1600027</b>	50
<b>CS-IPC 16/6</b>	<b>1970016</b>	50
<b>DFK-PC16-SS</b>	<b>1705449</b>	20
<b>SZK PH 1</b>	<b>1205150</b>	10
<b>SZS 0,6 x 2,5</b>	<b>1205040</b>	10
<b>SK 10/5</b> (see COMBICON catalog)		

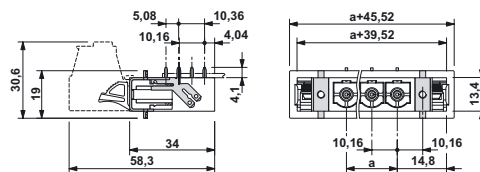
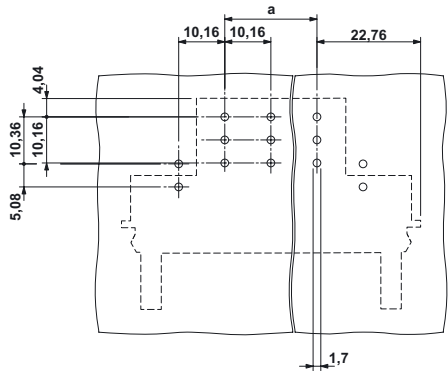

see description			
		I	
III / 3		III / 2	II / 2
1000		1000	1000
8		8	6
		41 <sup>1)</sup> / 76 <sup>1)</sup>	
		41 <sup>1)</sup> / 76 <sup>1)</sup>	
		PA	
		V0	
applied for			

<sup>1)</sup> 41 A with PC 6/... plug, 76 A with PC 16/... plug  
Observe derating curve

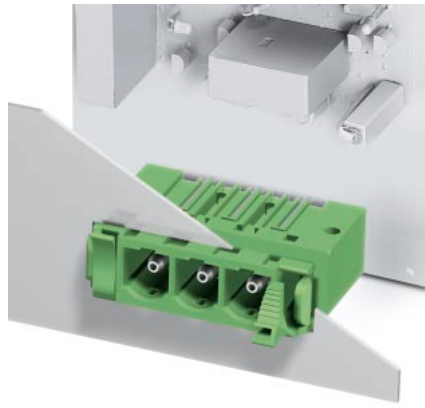

**POWER COMBICON**  
**Feed-through headers**  
**DFK-PCV 6-16/...-G-10,16**  
**10.16 mm pitch**



Description	No. of pos.	Dim. a [mm]	Type	Order No.	Pcs./Pkt.
<b>POWER COMBICON feed-through headers, pitch 10.16 mm, color: green, plug-in direction vertical to the PCB</b>	2	10.16	<b>DFK-PCV 6-16/ 2-G-10,16</b>	<b>1702099</b>	50
	3	20.32	<b>DFK-PCV 6-16/ 3-G-10,16</b>	<b>1702109</b>	
	4	30.48	<b>DFK-PCV 6-16/ 4-G-10,16</b>	<b>1702112</b>	
	5	40.64	<b>DFK-PCV 6-16/ 5-G-10,16</b>	<b>1702125</b>	
	6	50.80	<b>DFK-PCV 6-16/ 6-G-10,16</b>	<b>1702138</b>	
	7	60.96	<b>DFK-PCV 6-16/ 7-G-10,16</b>	<b>1702141</b>	
	8	71.12	<b>DFK-PCV 6-16/ 8-G-10,16</b>	<b>1702154</b>	
	9	81.28	<b>DFK-PCV 6-16/ 9-G-10,16</b>	<b>1702167</b>	
	(1) <b>Coding profile</b> , is inserted into the groove on the plug and header, red insulating material			<b>CP-HCC 4</b>	<b>1600027</b>
(2) <b>Coding pin</b> , serves to ensure correct polarization on the PCB during manual mounting			<b>CS-IPC 16/6</b>	<b>1970016</b>	50
(3) <b>Screw set</b> for securing the header to the device wall, consisting of DIN ISO 70 49 screw ST 2,9 x 9,5, only necessary if the enclosed screw fixing is used			<b>DFK-PC16-SS</b>	<b>1705449</b>	20
(4) <b>Screwdriver</b> , a) to actuate the screw fixing b) facilitates actuating the snap-lock mechanism			<b>SZK PH 1</b> <b>SZS 0,6 x 2,5</b>	<b>1205150</b> <b>1205040</b>	10 10
(5) <b>Marker card</b> , with 10 pcs. 10-section marker strips, white, self-adhesive, for 100 terminal blocks			<b>SK 10/5</b> (see COMBICON catalog)		
<b>Technical data</b>			see description		
Dimensions		[mm]	10.16		
Pitch		[mm]	1.7		
Hole diameter		[mm]	0.8 x 1.2		
Pin dimensions		[mm]x[mm]			
<b>Technical data in accordance with IEC/ DIN VDE</b>					
Insulating material group		—	I		
Surge voltage category / contamination class		—/—	III / 3	III / 2	II / 2
Rated voltage		[V]	1000	1000	1000
Rated surge voltage		[kV]	8	8	6
Nominal current		[A]	41 <sup>1)</sup> / 76 <sup>1)</sup>		
Maximum load current		[A]	41 <sup>1)</sup> / 76 <sup>1)</sup>		
<b>Insulating material</b>			PA		
Inflammability class in acc. with UL 94			V0		
<b>Approval data (UL/CUL and CSA)</b>			applied for		
Nominal voltage / current / conductor sizes			—		
UL/CUL: [V]/[A]/AWG					
CSA: [V]/[A]/AWG					

<sup>1)</sup> 41 A with PC 6/... plug, 76 A with PC 16/... plug  
 Observe derating curve

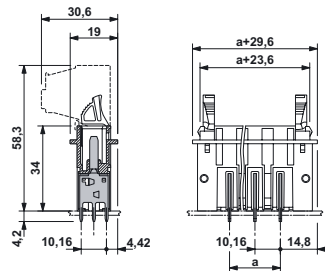
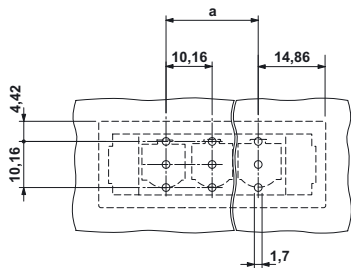



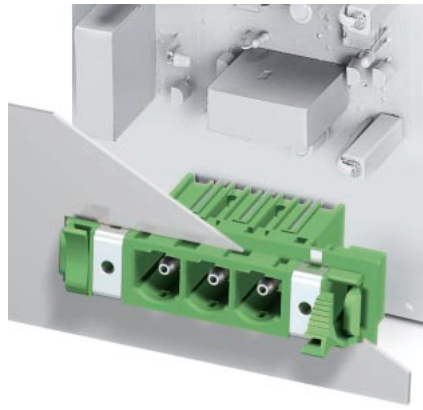

**POWER COMBICON**  
**Feed-through headers**  
**DFK-PCV 6-16/...-GF-10,16**  
**10.16 mm pitch**



Description	No. of pos.	Dim. a [mm]
<b>POWER COMBICON feed-through headers, pitch 10.16 mm, color: green,</b>	2	10.16
plug-in direction vertical to the PCB,	3	20.32
with threaded flange and integrated shield connection to the housing of the device	4	30.48
	5	40.64
	6	50.80
	7	60.96
	8	71.12
	9	81.28

- (1) **Coding profile**, is inserted into the groove on the plug and header, red insulating material 
- (2) **Coding pin**, serves to ensure correct polarization on the PCB during manual mounting 
- (3) **Screw set** for securing the header to the device wall, consisting of DIN ISO 70 49 screw ST 2,9 x 9,5, only necessary if the enclosed screw fixing is used
- (4) **Screwdriver**,  
a) to actuate the screw fixing  
b) facilitates actuating the snap-lock mechanism 
- (5) **Marker card**, with 10 pcs. 10-section marker strips, white, self-adhesive, for 100 terminal blocks

**Technical data**

Dimensions		see description
Pitch	[mm]	10.16
Hole diameter	[mm]	1.7
Pin dimensions	[mm]x[mm]	0.8 x 1.2

**Technical data in accordance with IEC/ DIN VDE**

Insulating material group	—	I
Surge voltage category / contamination class	—/—	III / 3    III / 2    II / 2
Rated voltage	[V]	1000    1000    1000
Rated surge voltage	[kV]	8    8    6
Nominal current	[A]	41 <sup>1)</sup> / 76 <sup>1)</sup>
Maximum load current	[A]	41 <sup>1)</sup> / 76 <sup>1)</sup>

**Insulating material**

Inflammability class in acc. with UL 94

**Approval data (UL/CUL and CSA)**

Nominal voltage / current / conductor sizes	UL/CUL: [V]/[A]/AWG	applied for
	CSA: [V]/[A]/AWG	—

Type	Order No.	Pcs./Pkt.
<b>DFK-PCV 6-16/ 2-GF-10,16</b>	<b>1702251</b>	50
<b>DFK-PCV 6-16/ 3-GF-10,16</b>	<b>1702264</b>	
<b>DFK-PCV 6-16/ 4-GF-10,16</b>	<b>1702277</b>	
<b>DFK-PCV 6-16/ 5-GF-10,16</b>	<b>1702280</b>	
<b>DFK-PCV 6-16/ 6-GF-10,16</b>	<b>1702293</b>	
<b>DFK-PCV 6-16/ 7-GF-10,16</b>	<b>1702303</b>	
<b>DFK-PCV 6-16/ 8-GF-10,16</b>	<b>1702316</b>	
<b>DFK-PCV 6-16/ 9-GF-10,16</b>	<b>1702329</b>	
<b>CP-HCC 4</b>	<b>1600027</b>	50
<b>CS-IPC 16/6</b>	<b>1970016</b>	50
<b>DFK-PC16-SS</b>	<b>1705449</b>	20
<b>SZK PH 1</b>	<b>1205150</b>	10
<b>SZS 0,6 x 2,5</b>	<b>1205040</b>	10
<b>SK 10/5</b> (see COMBICON catalog)		

<sup>1)</sup> 41 A with PC 6/... plug, 76 A with PC 16/... plug  
Observe derating curve

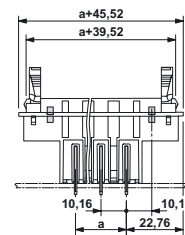
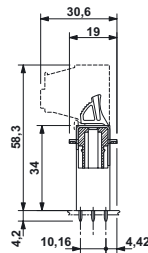
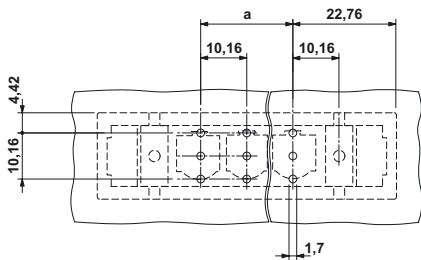

Sheet metal cutout for snap-on

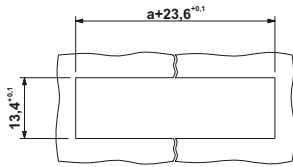

"-G-" and "-GU-" versions

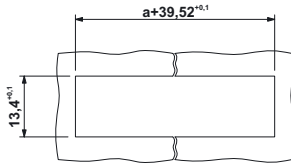

"-GF-" and "-GFU-" versions

Sheet metal cutout for screw connection

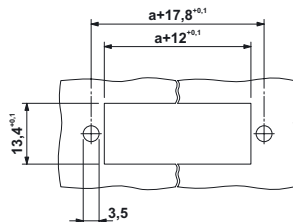

"-G-" and "-GU-" versions

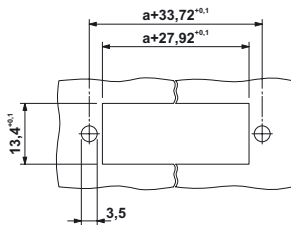

"-GF-" and "-GFU-" versions

Plug: DFK-PC(V) 6-16/...-G(F)(U)-(SH)-10,16  
 Header: PC 16/...-ST(F)-(SH)-10,16  
 Conductor cross section 16 mm<sup>2</sup>

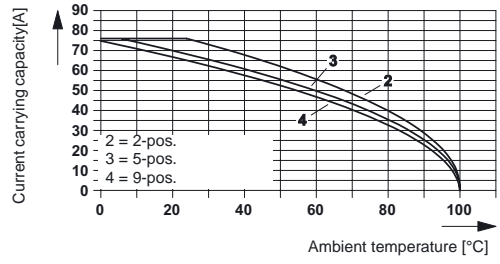



Компания «ЭлектроПласт» предлагает заключение долгосрочных отношений при поставках импортных электронных компонентов на взаимовыгодных условиях!

Наши преимущества:

- Оперативные поставки широкого спектра электронных компонентов отечественного и импортного производства напрямую от производителей и с крупнейших мировых складов;
- Поставка более 17-ти миллионов наименований электронных компонентов;
- Поставка сложных, дефицитных, либо снятых с производства позиций;
- Оперативные сроки поставки под заказ (от 5 рабочих дней);
- Экспресс доставка в любую точку России;
- Техническая поддержка проекта, помощь в подборе аналогов, поставка прототипов;
- Система менеджмента качества сертифицирована по Международному стандарту ISO 9001;
- Лицензия ФСБ на осуществление работ с использованием сведений, составляющих государственную тайну;
- Поставка специализированных компонентов (Xilinx, Altera, Analog Devices, Intersil, Interpoint, Microsemi, Aeroflex, Peregrine, Syfer, Eurofarad, Texas Instrument, Miteq, Cobham, E2V, MA-COM, Hittite, Mini-Circuits, General Dynamics и др.);

Помимо этого, одним из направлений компании «ЭлектроПласт» является направление «Источники питания». Мы предлагаем Вам помощь Конструкторского отдела:

- Подбор оптимального решения, техническое обоснование при выборе компонента;
- Подбор аналогов;
- Консультации по применению компонента;
- Поставка образцов и прототипов;
- Техническая поддержка проекта;
- Защита от снятия компонента с производства.



#### Как с нами связаться

**Телефон:** 8 (812) 309 58 32 (многоканальный)

**Факс:** 8 (812) 320-02-42

**Электронная почта:** [org@eplast1.ru](mailto:org@eplast1.ru)

**Адрес:** 198099, г. Санкт-Петербург, ул. Калинина, дом 2, корпус 4, литера А.