



TAOGLAS®



Datasheet

2.4/5.8GHz 5dBi Terminal Mount Dipole Antenna

Part No:
GW.51.5153

Description:

Wi-Fi 2.4/5.8GHz 5dBi Dipole Terminal Mount Antenna RP-SMA(M) Hinged

Features:

- 2.4/5.8GHz Band Operation
- 5dBi Gain
- High Efficiency up to 80%
- Hinged RP-SMA (M) Connector
- Height: 198mm
- Diameter: 13mm
- RoHS & Reach Compliant

1. Introduction	3
2. Specifications	4
3. Antenna Characteristics	5
4. Radiation Patterns	7
5. Mechanical Drawing	12
6. Packaging	13
<hr/>	
Changelog	14

Taoglas makes no warranties based on the accuracy or completeness of the contents of this document and reserves the right to make changes to specifications and product descriptions at any time without notice. Taoglas reserves all rights to this document and the information contained herein. Reproduction, use or disclosure to third parties without express permission is strictly prohibited.



1. Introduction



The Taoglas GW.51 is a 2.4 & 5.8GHz Wi-Fi terminal mount dipole antenna. At just 198mm in height and 13mm in diameter, the robust TPEE enclosure can be mounted straight or at right angle to the device with its hinged RP-SMA(M) connector. It is ideal for applications such as Bluetooth, BLE, ZigBee and Wireless LAN. The GW.82, designed for superior performance and reliability, has an omnidirectional radiation pattern and extremely high efficiency and gain on both the 2.4 & 5.8GHz bands.

Typical applications include:

- Smart Home
- Gateways/Routers
- Connected Agriculture

The GW.51 has up to 5dBi Peak making it a cost-effective, high-performing choice for any indoor or outdoor application. Many module manufacturers specify peak gain limits for any antennas that are to be connected to that module. Those peak gain limits are based on free-space conditions. In practice, the peak gain of an antenna tested in free-space can degrade by at least 1 or 2dBi when installed. So ideally you should go for a slightly higher peak gain antenna than mentioned on the module specification to compensate for this effect. This provides you with improved performance. Upon testing of any of our antennas with your device and appropriate layout, integration technique, or cable, we can work with you to make any of our antennas' perform below the peak gain limits. Taoglas can then issue a specification and/or report for the selected antenna in your device that will clearly show it complying with the peak gain limits. You can be assured that you are meeting the regulatory requirements for that module whilst getting the best performance possible, without exceeding the peak gain limits.

For further information, or support to test and integrate this product please contact your regional Taoglas customer support team.

2. Specifications

Electrical		
Frequency (MHz)	2400~2500	4900~5850
Efficiency (%)		
Straight	71.56	71.84
Bent	80.73	79.80
Average Gain (dB)		
Straight	-1.45	-1.44
Bent	-0.93	-0.98
Peak Gain (dBi)		
Straight	3.14	3.08
Bent	6.12	3.98
Impedance	50Ω	
Polarization	Linear	
Radiation Pattern	Omni	
Max. input power	1W	
Mechanical		
Height	198 ±3.3 mm	
Planner Dimension	198*Ø13 mm	
Casing	TPEE	
Connector	RP-SMA(M)	
Weight	22.5 g	
Environmental		
Temperature Range	-40°C to 85°C	
Humidity	Non-condensing 65°C 95% RH	

3. Antenna Characteristics

3.1 Return Loss

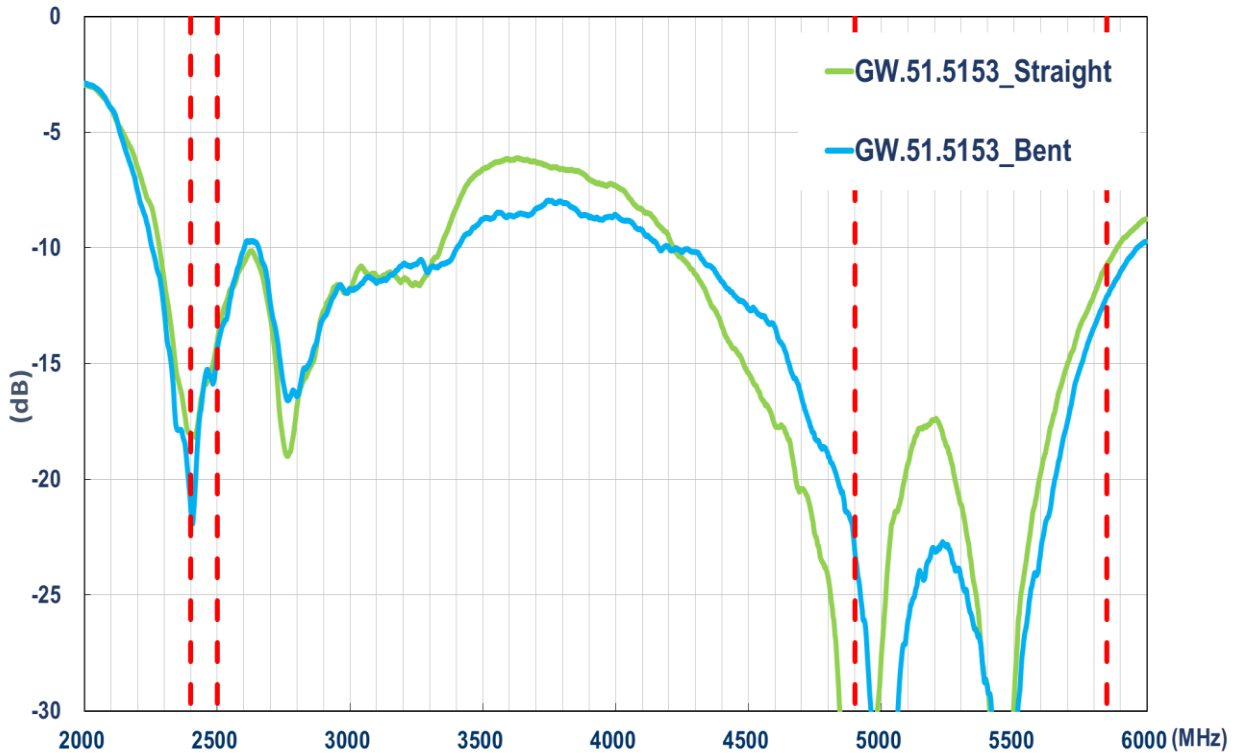

3.2 Efficiency

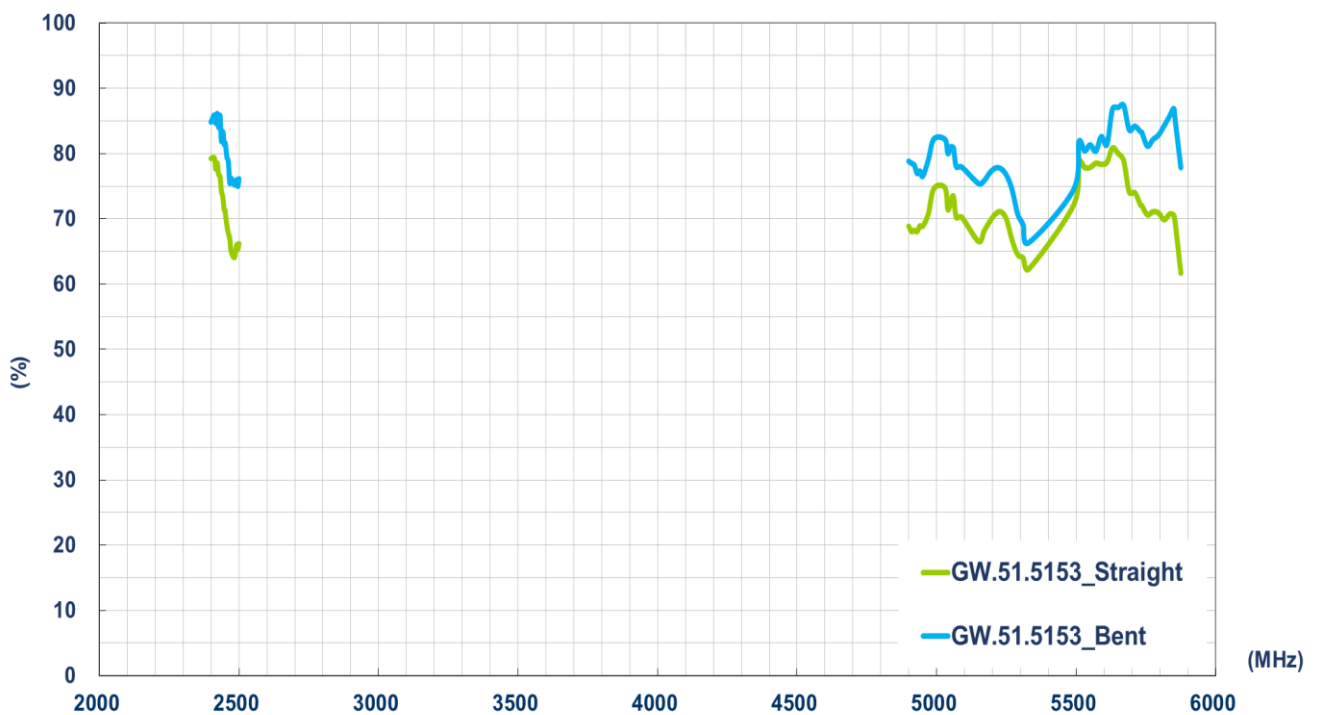

3.3 Average Gain

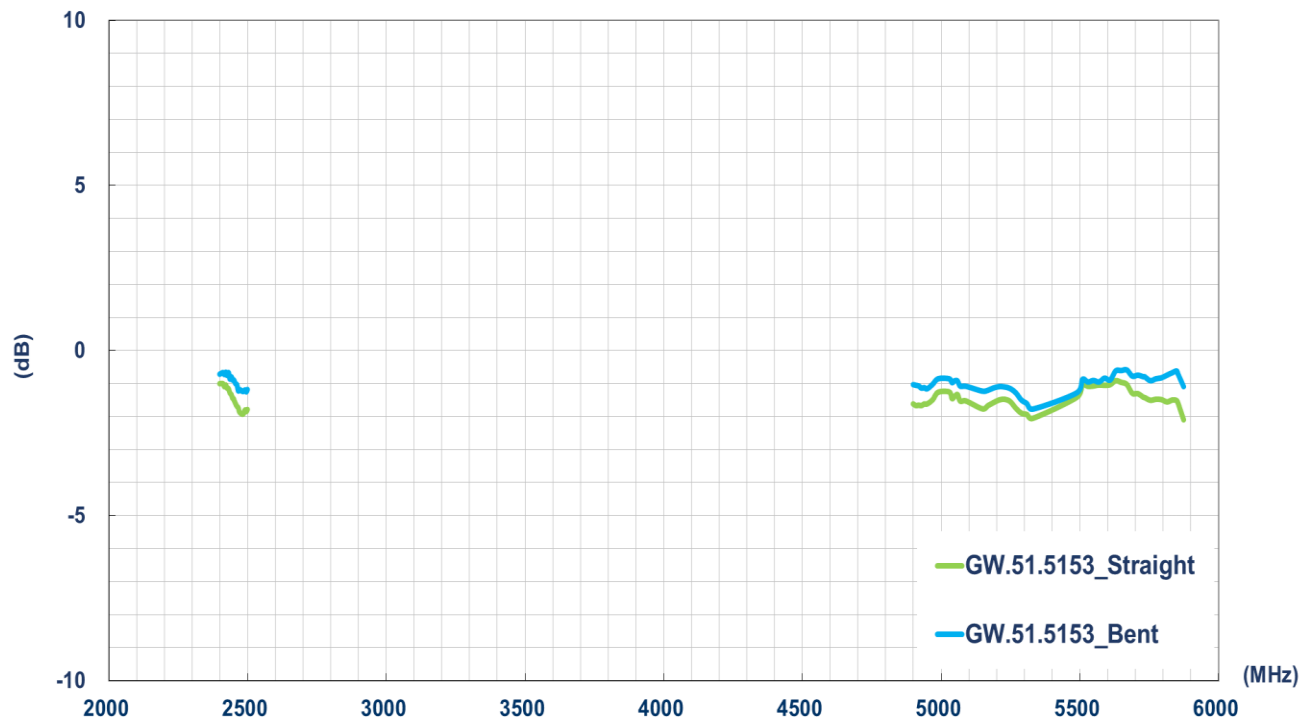

3.4 Peak Gain

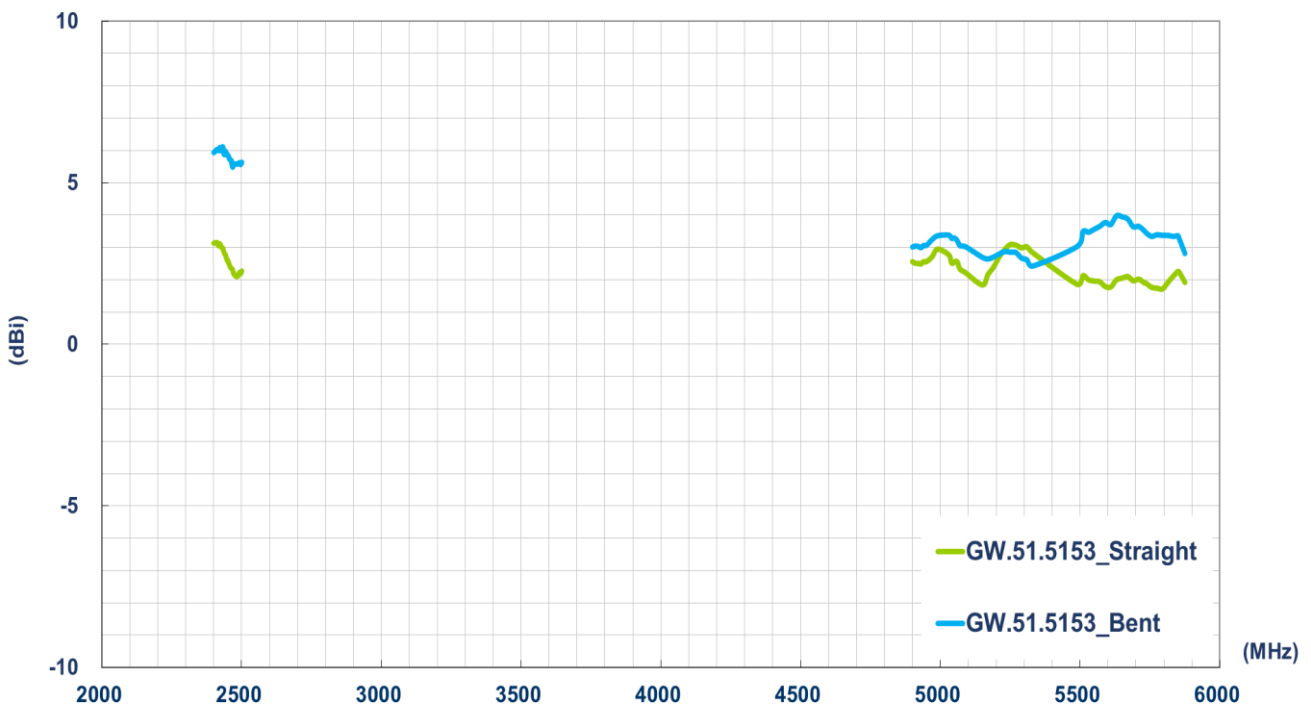

4. Radiation Patterns

4.1 Test Setup



Free space - Straight



Free space - Bent

4.2 2450MHz 3D and 2D Radiation Patterns - Straight

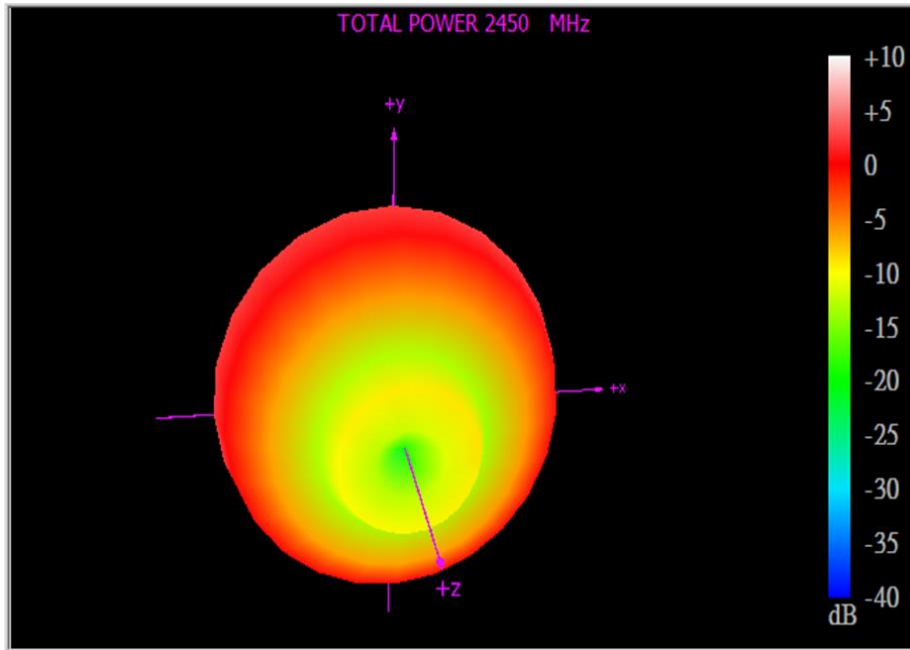

XY Plane

XZ Plane

YZ Plane

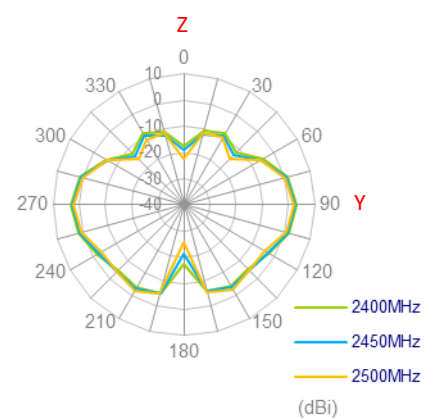
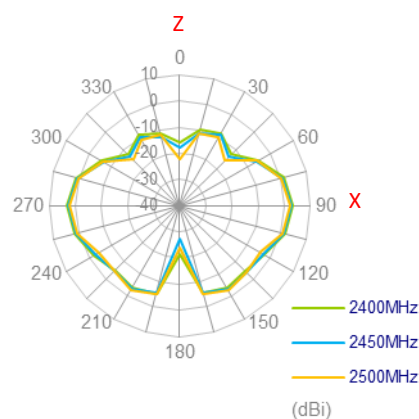
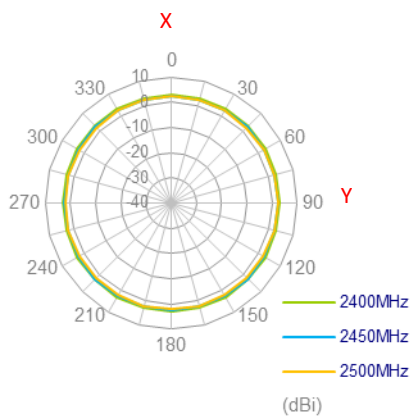

4.3 5550MHz 3D and 2D Radiation Patterns - Straight

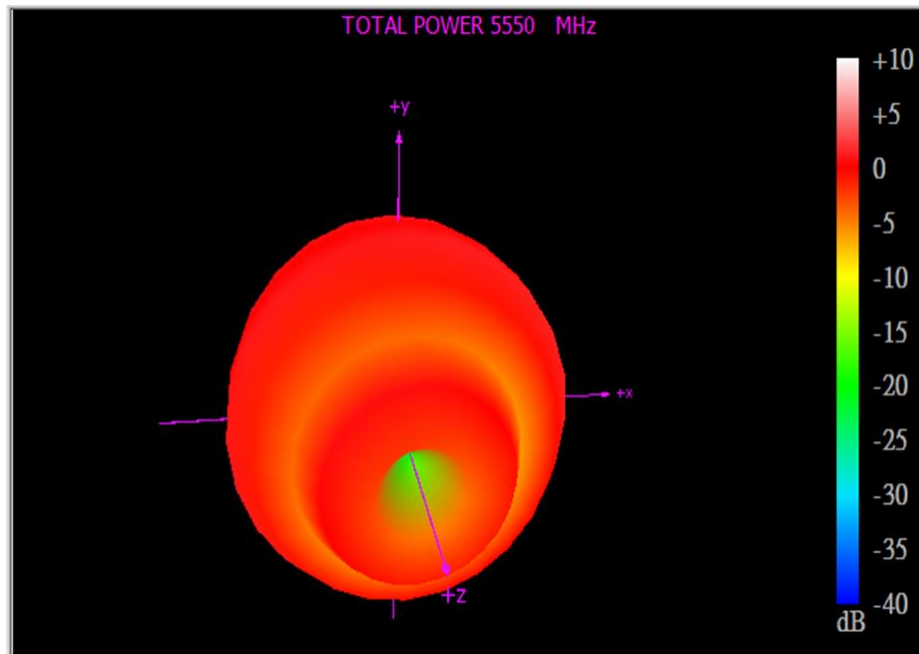

XY Plane

XZ Plane

YZ Plane

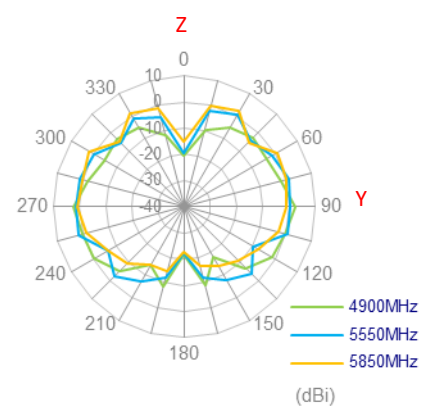
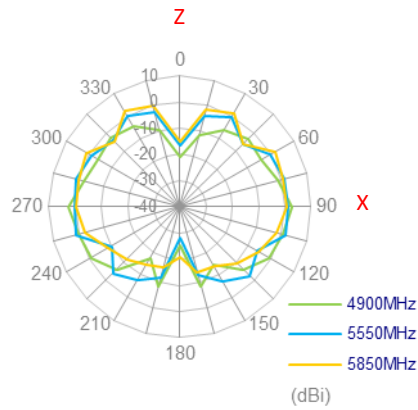
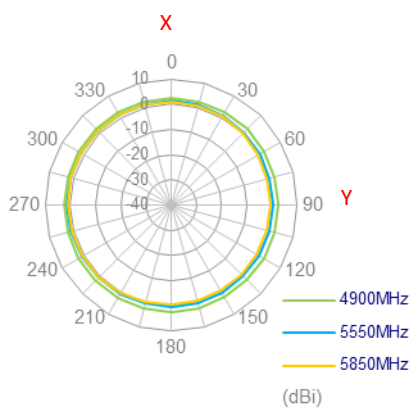

4.4 2450MHz 3D and 2D Radiation Patterns - Bent

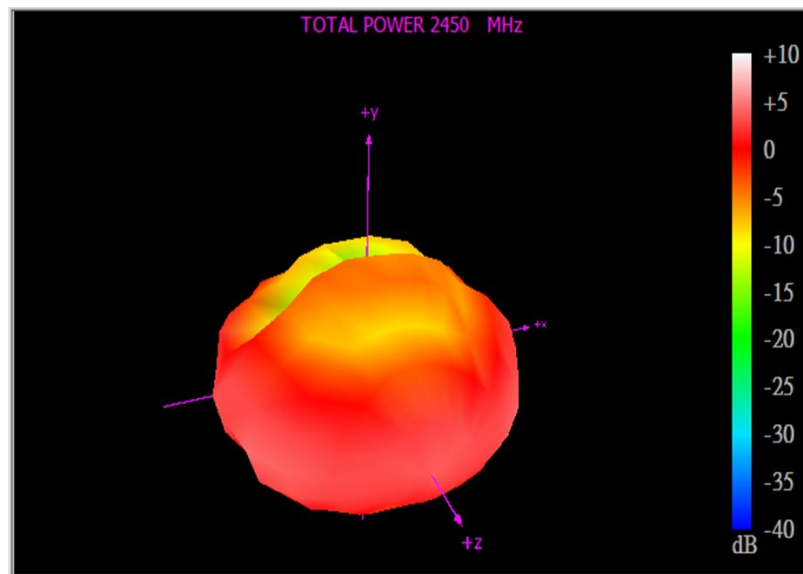

XY Plane

XZ Plane

YZ Plane

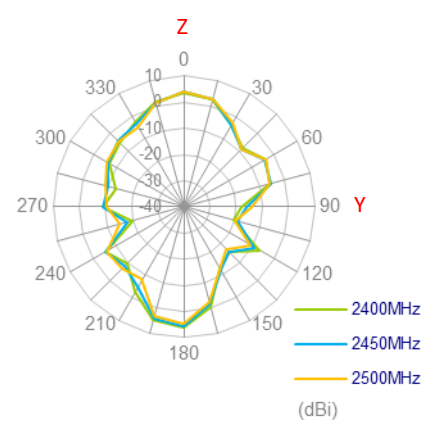
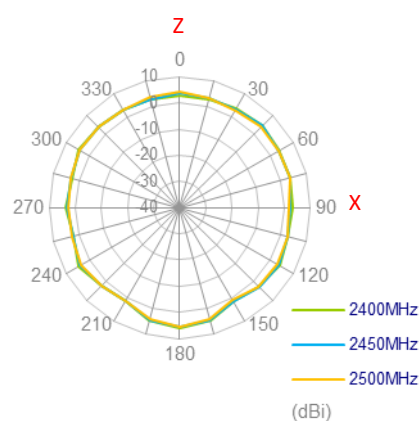
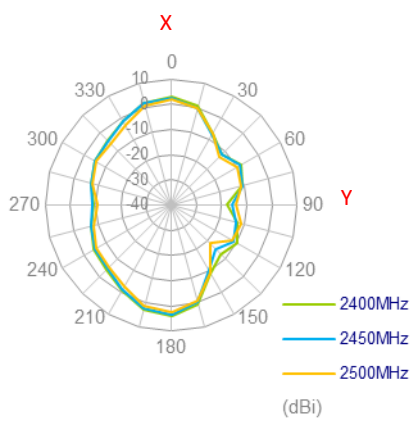

4.5 5550MHz 3D and 2D Radiation Patterns - Bent

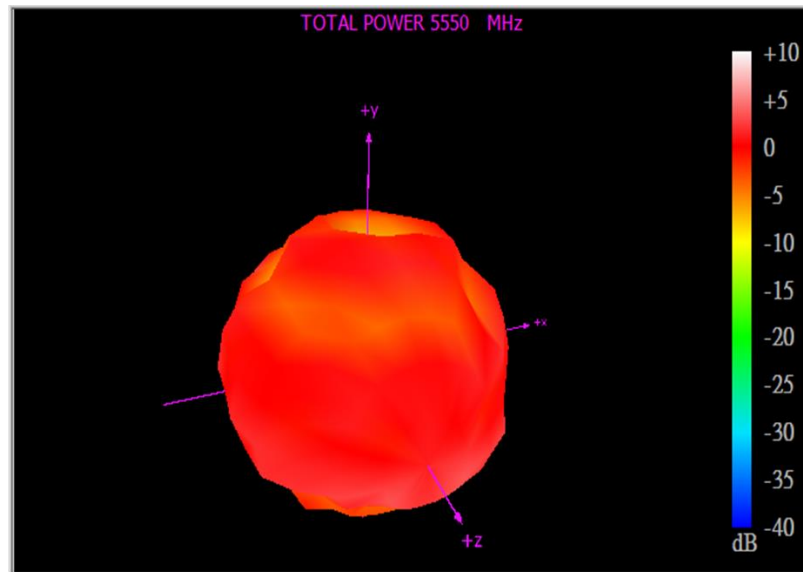

XY Plane

XZ Plane

YZ Plane

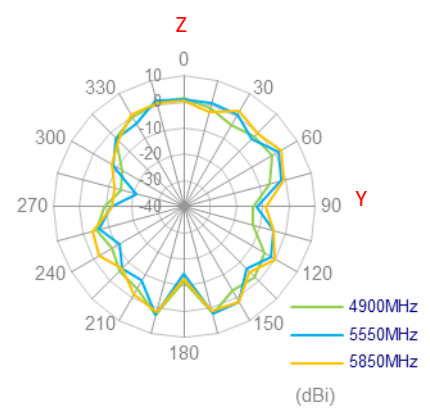
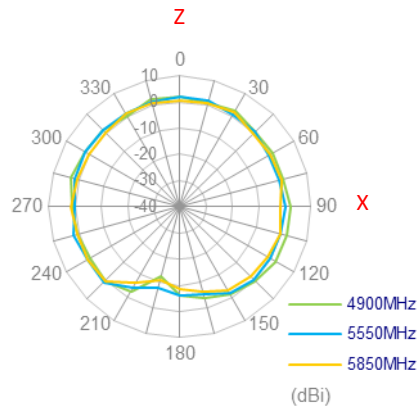
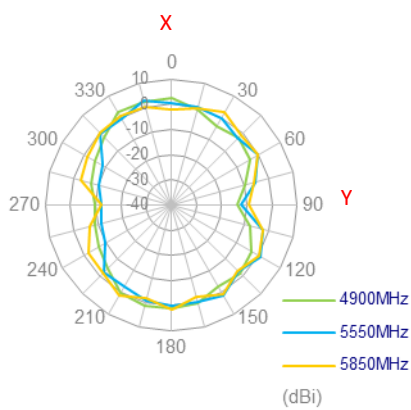

5. Mechanical Drawing (Units: mm)

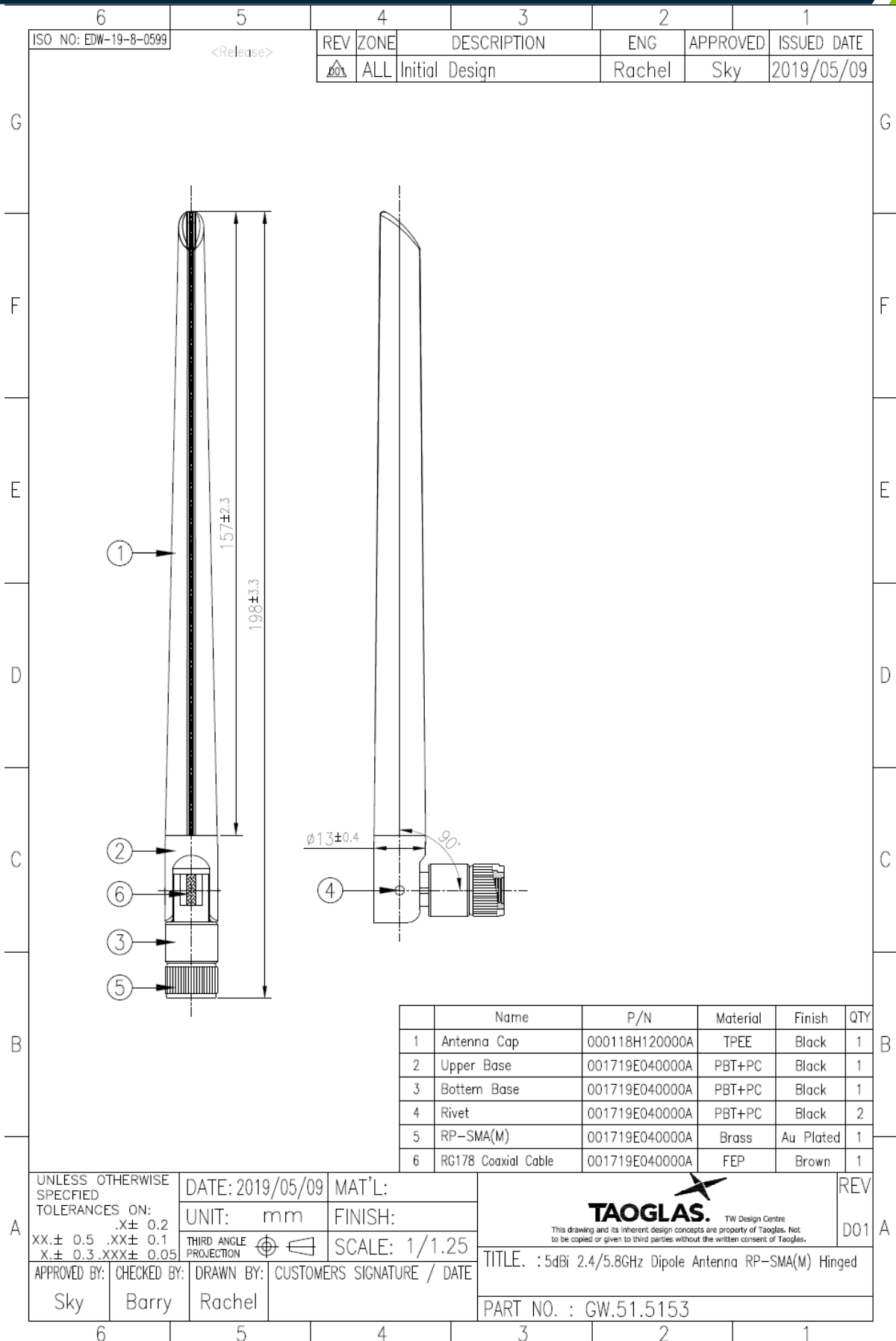

6. Packaging

1pc GW.51.5153 per PE Bag
 Bag Dimension: 245*30mm
 Weight: 22.5g

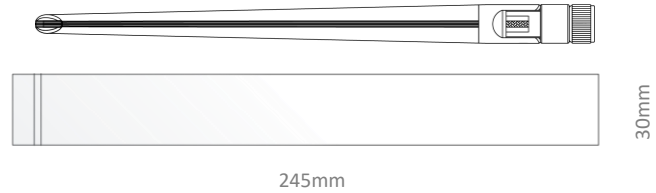

40pcs GW.51.5153 per Large PE Bag
 Bag Dimensions: 320*205mm
 Weight: 0.9Kg

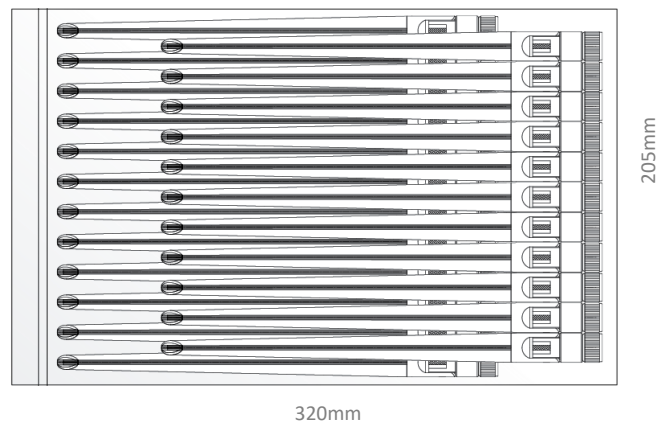

400pcs GW.51.5153 per Carton
 Dimensions: 320*250*230mm
 Weight: 10Kg

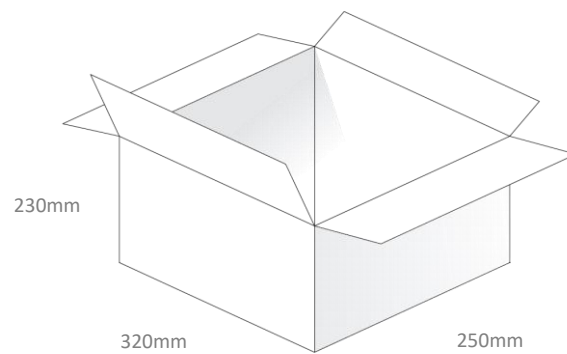

Pallet Dimensions:
 1200*1000*1350mm
 60 Cartons Per Pallet
 12 Cartons Per Layer, 5 Layers

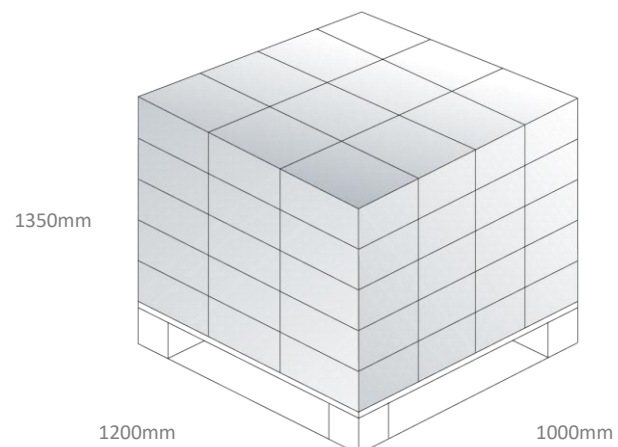

Changelog for the datasheet

SPE-19-8-087 – GW.51.5153

Revision: A (Original First Release)	
Date:	2019-06-24
Notes:	
Author:	Jack Conroy

Previous Revisions



TAOGLAS®

www.taoglas.com





Компания «ЭлектроПласт» предлагает заключение долгосрочных отношений при поставках импортных электронных компонентов на взаимовыгодных условиях!

Наши преимущества:

- Оперативные поставки широкого спектра электронных компонентов отечественного и импортного производства напрямую от производителей и с крупнейших мировых складов;
- Поставка более 17-ти миллионов наименований электронных компонентов;
- Поставка сложных, дефицитных, либо снятых с производства позиций;
- Оперативные сроки поставки под заказ (от 5 рабочих дней);
- Экспресс доставка в любую точку России;
- Техническая поддержка проекта, помощь в подборе аналогов, поставка прототипов;
- Система менеджмента качества сертифицирована по Международному стандарту ISO 9001;
- Лицензия ФСБ на осуществление работ с использованием сведений, составляющих государственную тайну;
- Поставка специализированных компонентов (Xilinx, Altera, Analog Devices, Intersil, Interpoint, Microsemi, Aeroflex, Peregrine, Syfer, Eurofarad, Texas Instrument, Miteq, Cobham, E2V, MA-COM, Hittite, Mini-Circuits, General Dynamics и др.);

Помимо этого, одним из направлений компании «ЭлектроПласт» является направление «Источники питания». Мы предлагаем Вам помощь Конструкторского отдела:

- Подбор оптимального решения, техническое обоснование при выборе компонента;
- Подбор аналогов;
- Консультации по применению компонента;
- Поставка образцов и прототипов;
- Техническая поддержка проекта;
- Защита от снятия компонента с производства.



Как с нами связаться

Телефон: 8 (812) 309 58 32 (многоканальный)

Факс: 8 (812) 320-02-42

Электронная почта: org@eplast1.ru

Адрес: 198099, г. Санкт-Петербург, ул. Калинина, дом 2, корпус 4, литера А.