

IDC Socket: WTB

24-9159



AVX developed the 9159 Series of SMT connectors for co-planar PCB mating for the challenging Solid State Lighting (SSL) market. These connectors needed to be small, low in height, carry up to 5 Amps/contact and then function up to 125C for extended periods. This application has been very unique to the SSL market where PCB's are stacked end-to-end to create linear strip lighting in everything from office to transportation applications where products are exposed to harsh mechanical and environmental environments.

The IDC cable socket connector allows for 22-24AWG discrete or cabled wires to be easily and reliability terminated into a 9159 standard interface plug connector. This will allow power and signals to be connectors onto a PCB socket connector while providing positive latching. The wire assembly support block allows for 2 through 6 wires to be terminated all in one step with any standard bench top press. IDC covers provide both through (daisy chain applications) and wire stop termination options.

APPLICATIONS

- Provides Wire-to-Board capabilities to standard 9159 2-Piece connector system
- In conjunction with the IDC plug WTB connector (14-9159), these connectors provide maximum flexibility to bring power and signal wires onto or off of any board level 9159 connector
- Reference application notes 201-01-123
- Reference Product Specification 201-01-119

FEATURES AND BENEFITS

- Mates with standard 9159 horizontal plug, keeping same BTB connector system
- Economical and reliable IDC wire termination
- Gold plated BeCu contact system for high reliability in harsh environments
- Integrally molded latch offers positive latching after mating

ELECTRICAL

- Current Rating: 5 Amps / Contact
- Voltage Rating: 125 VAC

ENVIRONMENTAL

- Operating Temperature: -40°C to +125°C

MECHANICAL

- Insulator Material: Nylon: UL94VO
- Contact Material: Phosphor Bronze
- Plating: Gold / Tin over Nickel
- Durability: 10 Cycles

HOW TO ORDER

<p>24</p> <p>Prefix</p> <p>Right Angle Wired Socket IDC Terminations</p>	<p>9159</p> <p>Series</p>	<p>00X</p> <p>Number of Ways</p> <table border="1"> <thead> <tr> <th>Code</th> <th>No of Ways</th> <th>Details</th> </tr> </thead> <tbody> <tr> <td colspan="3">THROUGH WIRE CAP</td> </tr> <tr> <td>002</td> <td>2</td> <td>Page 2</td> </tr> <tr> <td>003</td> <td>3</td> <td>Page 3</td> </tr> <tr> <td>004</td> <td>4</td> <td>Page 4</td> </tr> <tr> <td>005</td> <td>5</td> <td>Page 5</td> </tr> <tr> <td>006</td> <td>6</td> <td>Page 6</td> </tr> <tr> <td colspan="3">WIRE STOP CAP</td> </tr> <tr> <td>002</td> <td>2</td> <td>Page 7</td> </tr> <tr> <td>003</td> <td>3</td> <td>Page 8</td> </tr> <tr> <td>004</td> <td>4</td> <td>Page 9</td> </tr> <tr> <td>005</td> <td>5</td> <td>Page 10</td> </tr> <tr> <td>006</td> <td>6</td> <td>Page 11</td> </tr> </tbody> </table>	Code	No of Ways	Details	THROUGH WIRE CAP			002	2	Page 2	003	3	Page 3	004	4	Page 4	005	5	Page 5	006	6	Page 6	WIRE STOP CAP			002	2	Page 7	003	3	Page 8	004	4	Page 9	005	5	Page 10	006	6	Page 11	<p>1</p> <p>2 Part PCB Strip Connector</p> <p>2 Part Wired IDC Strip Connector</p>	<p>X</p> <p>Wire Gauge</p> <p>2 = 22AWG 3 = 24AWG</p>	<p>2</p> <p>Wire Insulation Diameter</p> <p>ø1.10mm to ø1.60mm</p>	<p>9</p> <p>Color Options</p> <p>9 = UL</p>	<p>X</p> <p>Cap Options</p> <table border="1"> <thead> <tr> <th>Code</th> <th>Cap Option</th> <th>Description</th> </tr> </thead> <tbody> <tr> <td>0</td> <td>Through Wire</td> <td>Allows wires to be terminated at any point</td> </tr> <tr> <td>9</td> <td>Wire Stop</td> <td>Terminates end of wire. End protected with Stop Face</td> </tr> </tbody> </table>	Code	Cap Option	Description	0	Through Wire	Allows wires to be terminated at any point	9	Wire Stop	Terminates end of wire. End protected with Stop Face	<p>6</p> <p>Plating Option</p> <table border="1"> <thead> <tr> <th>Code</th> <th>Contact</th> </tr> </thead> <tbody> <tr> <td>6</td> <td>Gold on Contact Tin on IDC</td> </tr> </tbody> </table>	Code	Contact	6	Gold on Contact Tin on IDC
Code	No of Ways	Details																																																										
THROUGH WIRE CAP																																																												
002	2	Page 2																																																										
003	3	Page 3																																																										
004	4	Page 4																																																										
005	5	Page 5																																																										
006	6	Page 6																																																										
WIRE STOP CAP																																																												
002	2	Page 7																																																										
003	3	Page 8																																																										
004	4	Page 9																																																										
005	5	Page 10																																																										
006	6	Page 11																																																										
Code	Cap Option	Description																																																										
0	Through Wire	Allows wires to be terminated at any point																																																										
9	Wire Stop	Terminates end of wire. End protected with Stop Face																																																										
Code	Contact																																																											
6	Gold on Contact Tin on IDC																																																											



Certification: UL File #E90723

SOCKET WIRED – 2 WAY THROUGH WIRE CAP

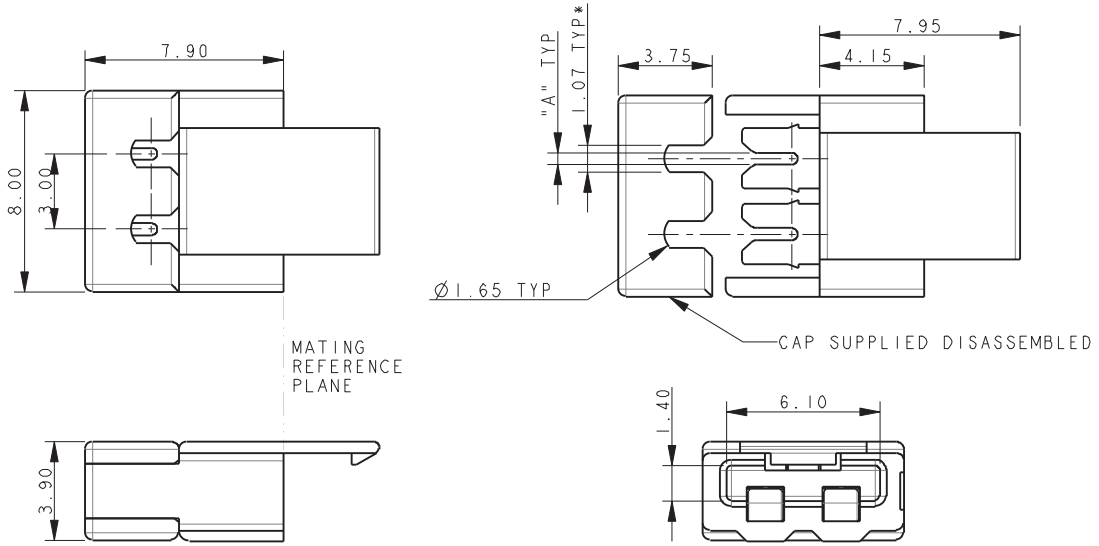

NOTES:

1. FOR MORE INFORMATION REFER TO PRODUCT SPEC 201-01-119.
FOR WIRE ASSEMBLY REFER TO APPLICATION NOTES 201-01-123.
2. THROUGH WIRE CAP, FOR TERMINATION OF WIRE IN ANY POSITION.
3. CAP ACTS AS WIRE ASSEMBLY TOOL. WIRE PREFIT TO CAP, NARROW SLOT TO GRIP WIRE, PERMANENT ASSEMBLY.
4. GENERAL TOLERANCE ± 0.20 UNLESS SPECIFIED.
5. INSULATOR MATERIAL: NYLON 46, GLASS FILLED, UL94 V-0. COLOR REFER TO PAGE 1.
6. CONTACT MATERIAL: COPPER ALLOY, PLATING NICKEL BASE ALL OVER, GOLD ON CONTACT, TIN ON IDC.
7. PACKING IN TAPE AND REEL. QTY PER REEL 700, POCKET CONTAINS 1 CONNECTOR AND 1 CAP.
8. WIRE GAUGE OPTIONS, SEE TABLE.
9. ASSEMBLY AIDS, REFER TO PAGE 12.

Wire Gauge	Code (page 1)	Dimension A	Wire Insulation Diameter
22AWG (Stranded Wire)	122	0.47	1.10 to 1.60
24AWG (Stranded Wire)	132	0.37	1.10 to 1.60

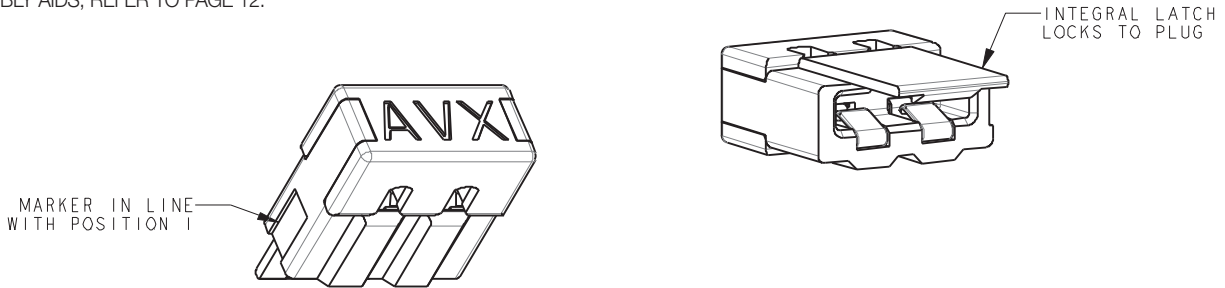

PACKING DETAILS CAP AND CONNECTOR SUPPLIED TOGETHER (2 PARTS)

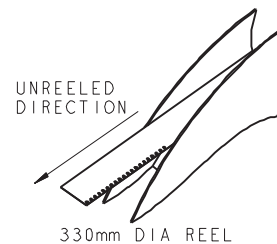
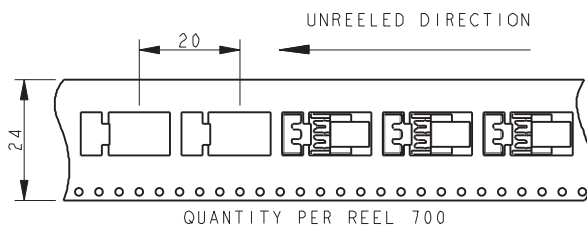

SOCKET WIRED – 3 WAY THROUGH WIRE CAP

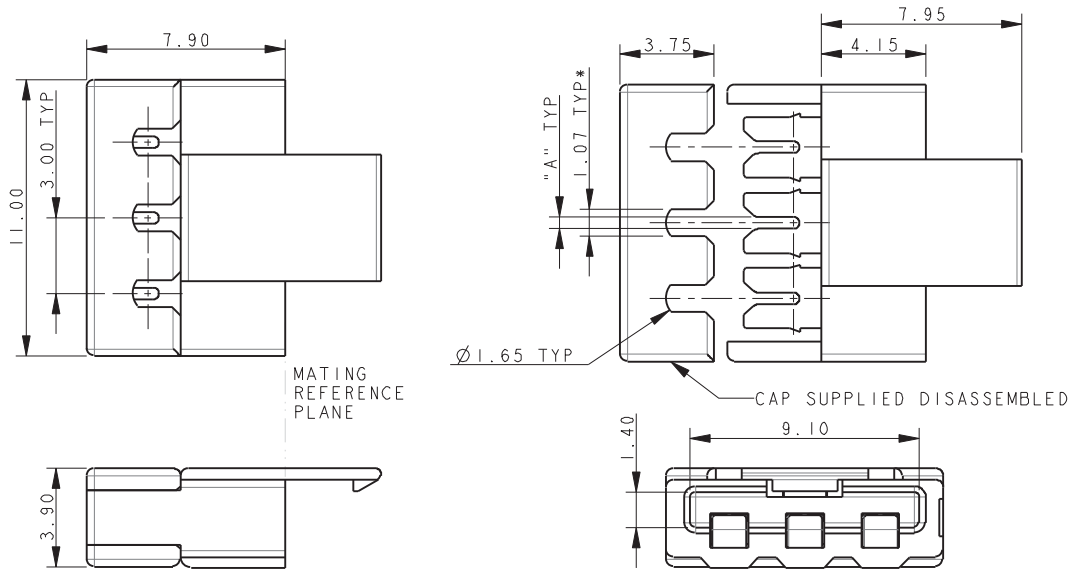

NOTES:

1. FOR MORE INFORMATION REFER TO PRODUCT SPEC 201-01-119.
FOR WIRE ASSEMBLY REFER TO APPLICATION NOTES 201-01-123.
2. THROUGH WIRE CAP, FOR TERMINATION OF WIRE IN ANY POSITION.
3. CAP ACTS AS WIRE ASSEMBLY TOOL. WIRE PREFIT TO CAP, NARROW SLOT TO GRIP WIRE, PERMANENT ASSEMBLY.
4. GENERAL TOLERANCE ± 0.20 UNLESS SPECIFIED.
5. INSULATOR MATERIAL: NYLON 46, GLASS FILLED, UL94 V-0. COLOR REFER TO PAGE 1.
6. CONTACT MATERIAL: COPPER ALLOY, PLATING NICKEL BASE ALL OVER, GOLD ON CONTACT, TIN ON IDC.
7. PACKING IN TAPE AND REEL. QTY PER REEL 700, POCKET CONTAINS 1 CONNECTOR AND 1 CAP.
8. WIRE GAUGE OPTIONS, SEE TABLE.
9. ASSEMBLY AIDS, REFER TO PAGE 12.

Wire Gauge	Code (page 1)	Dimension A	Wire Insulation Diameter
22AWG (Stranded Wire)	122	0.47	1.10 to 1.60
24AWG (Stranded Wire)	132	0.37	1.10 to 1.60

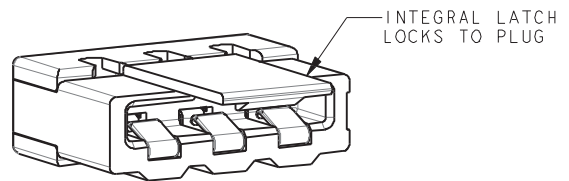
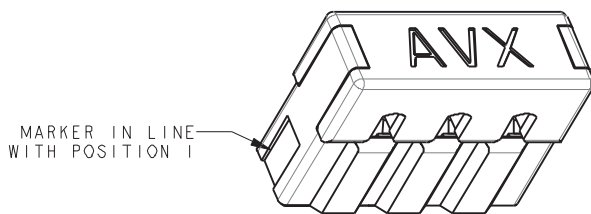

PACKING DETAILS CAP AND CONNECTOR SUPPLIED TOGETHER (2 PARTS)

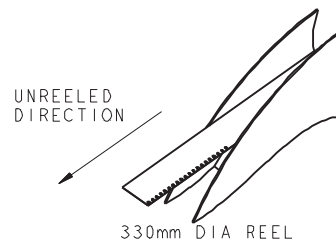
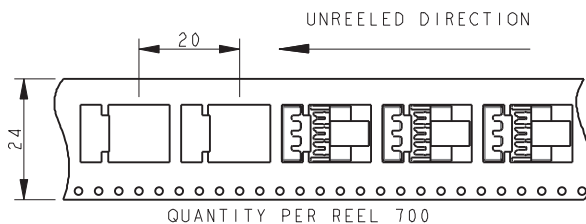

SOCKET WIRED – 4 WAY THROUGH WIRE CAP

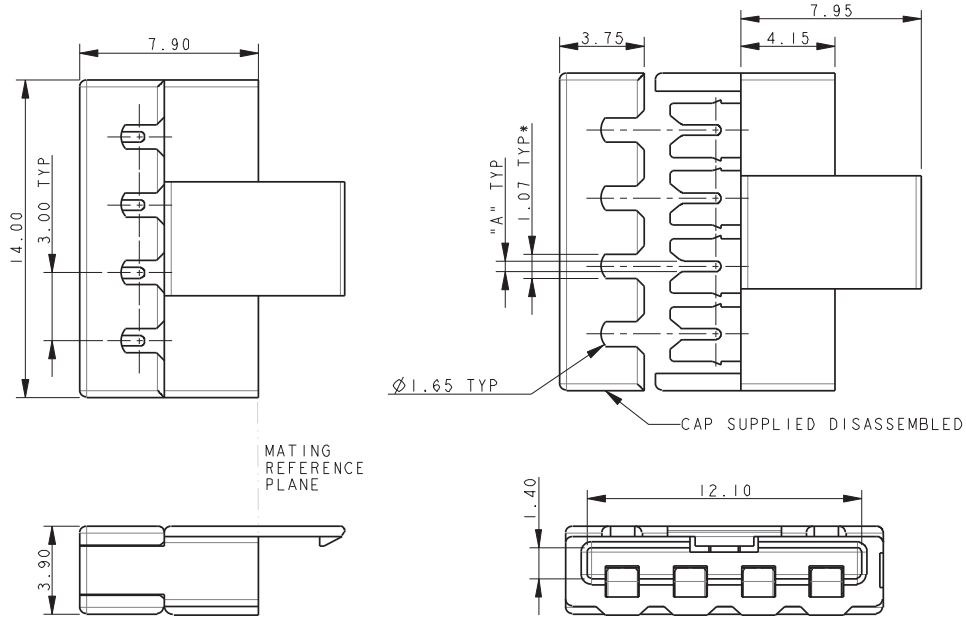

NOTES:

1. FOR MORE INFORMATION REFER TO PRODUCT SPEC 201-01-119.
FOR WIRE ASSEMBLY REFER TO APPLICATION NOTES 201-01-123.
2. THROUGH WIRE CAP, FOR TERMINATION OF WIRE IN ANY POSITION.
3. CAP ACTS AS WIRE ASSEMBLY TOOL. WIRE PREFIT TO CAP, NARROW SLOT TO GRIP WIRE, PERMANENT ASSEMBLY.
4. GENERAL TOLERANCE ± 0.20 UNLESS SPECIFIED.
5. INSULATOR MATERIAL: NYLON 46, GLASS FILLED, UL94 V-0. COLOR REFER TO PAGE 1.
6. CONTACT MATERIAL: COPPER ALLOY, PLATING NICKEL BASE ALL OVER, GOLD ON CONTACT, TIN ON IDC.
7. PACKING IN TAPE AND REEL. QTY PER REEL 700, POCKET CONTAINS 1 CONNECTOR AND 1 CAP.
8. WIRE GAUGE OPTIONS, SEE TABLE.
9. ASSEMBLY AIDS, REFER TO PAGE 12.

Wire Gauge	Code (page 1)	Dimension A	Wire Insulation Diameter
22AWG (Stranded Wire)	122	0.47	1.10 to 1.60
24AWG (Stranded Wire)	132	0.37	1.10 to 1.60

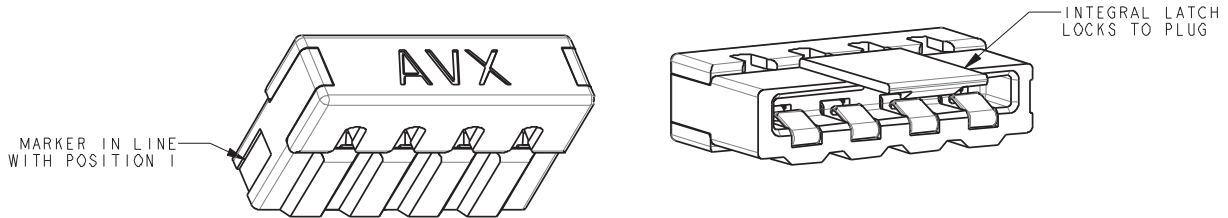

PACKING DETAILS CAP AND CONNECTOR SUPPLIED TOGETHER (2 PARTS)

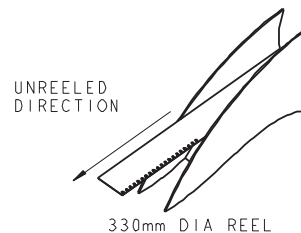
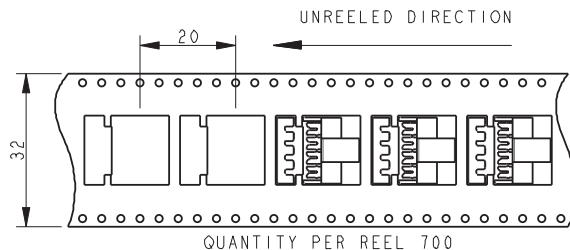

SOCKET WIRED – 5 WAY THROUGH WIRE CAP

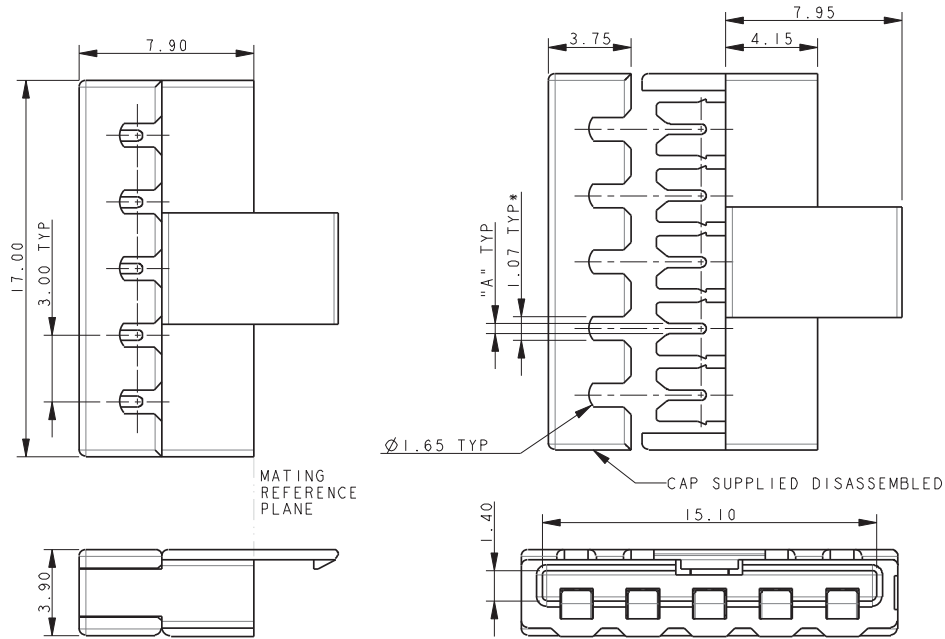

NOTES:

- FOR MORE INFORMATION REFER TO PRODUCT SPEC 201-01-119.
FOR WIRE ASSEMBLY REFER TO APPLICATION NOTES 201-01-123.
- THROUGH WIRE CAP, FOR TERMINATION OF WIRE IN ANY POSITION.
- CAP ACTS AS WIRE ASSEMBLY TOOL. WIRE PREFIT TO CAP, NARROW SLOT TO GRIP WIRE, PERMANENT ASSEMBLY.
- GENERAL TOLERANCE ± 0.20 UNLESS SPECIFIED.
- INSULATOR MATERIAL: NYLON 46, GLASS FILLED, UL94 V-0. COLOR REFER TO PAGE 1.
- CONTACT MATERIAL: COPPER ALLOY, PLATING NICKEL BASE ALL OVER, GOLD ON CONTACT, TIN ON IDC.
- PACKING IN TAPE AND REEL. QTY PER REEL 700, POCKET CONTAINS 1 CONNECTOR AND 1 CAP.
- WIRE GAUGE OPTIONS, SEE TABLE.
- ASSEMBLY AIDS, REFER TO PAGE 12.

Wire Gauge	Code (page 1)	Dimension A	Wire Insulation Diameter
22AWG (Stranded Wire)	122	0.47	1.10 to 1.60
24AWG (Stranded Wire)	132	0.37	1.10 to 1.60

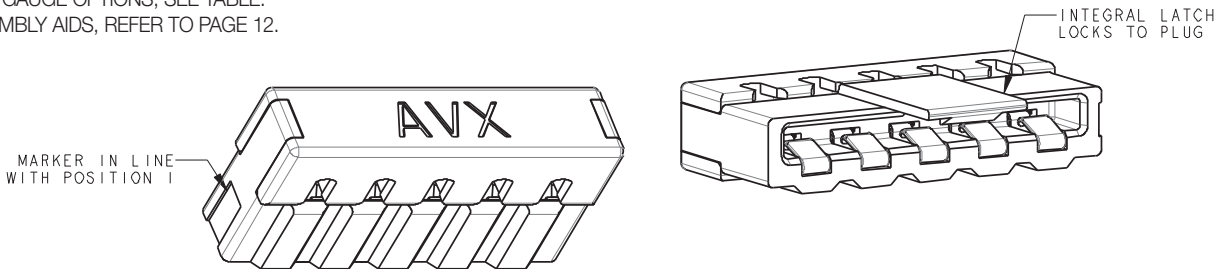

PACKING DETAILS CAP AND CONNECTOR SUPPLIED TOGETHER (2 PARTS)

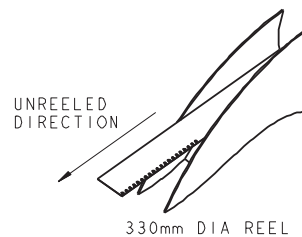
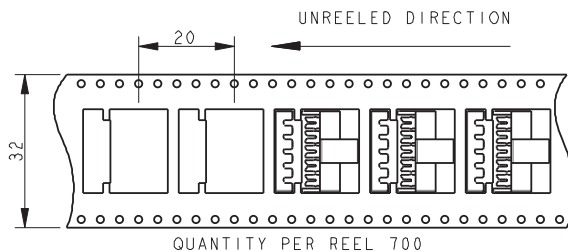

SOCKET WIRED – 6 WAY THROUGH WIRE CAP

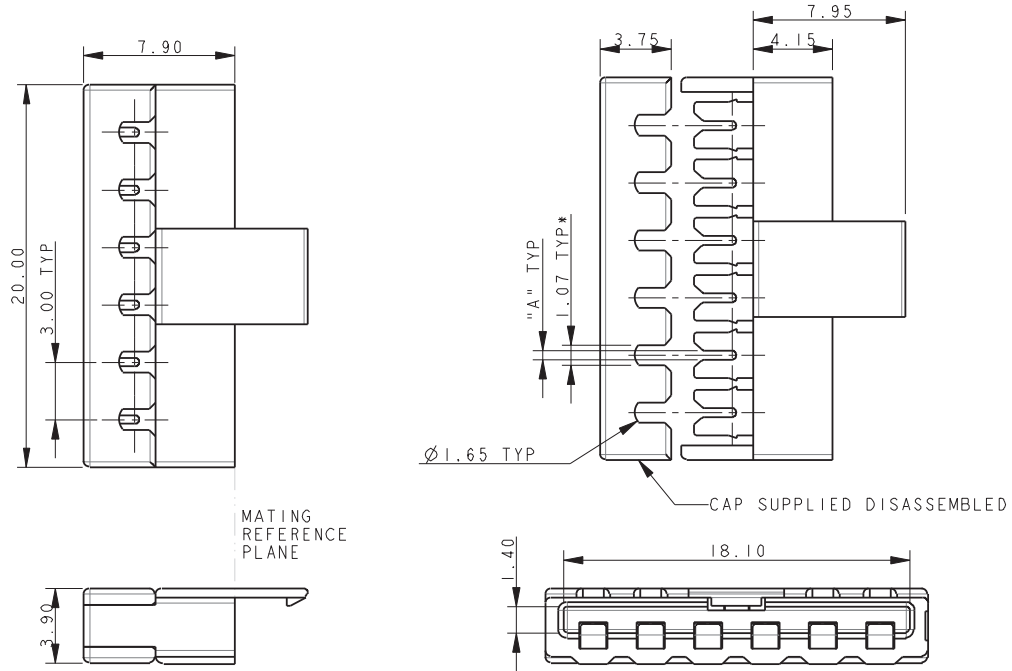

NOTES:

1. FOR MORE INFORMATION REFER TO PRODUCT SPEC 201-01-119.
FOR WIRE ASSEMBLY REFER TO APPLICATION NOTES 201-01-123.
2. THROUGH WIRE CAP, FOR TERMINATION OF WIRE IN ANY POSITION.
3. CAP ACTS AS WIRE ASSEMBLY TOOL. WIRE PREFIT TO CAP, NARROW SLOT TO GRIP WIRE, PERMANENT ASSEMBLY.
4. GENERAL TOLERANCE ± 0.20 UNLESS SPECIFIED.
5. INSULATOR MATERIAL: NYLON 46, GLASS FILLED, UL94 V-0. COLOR REFER TO PAGE 1.
6. CONTACT MATERIAL: COPPER ALLOY, PLATING NICKEL BASE ALL OVER, GOLD ON CONTACT, TIN ON IDC.
7. PACKING IN TAPE AND REEL. QTY PER REEL 700, POCKET CONTAINS 1 CONNECTOR AND 1 CAP.
8. WIRE GAUGE OPTIONS, SEE TABLE.
9. ASSEMBLY AIDS, REFER TO PAGE 12.

Wire Gauge	Code (page 1)	Dimension A	Wire Insulation Diameter
22AWG (Stranded Wire)	122	0.47	1.10 to 1.60
24AWG (Stranded Wire)	132	0.37	1.10 to 1.60

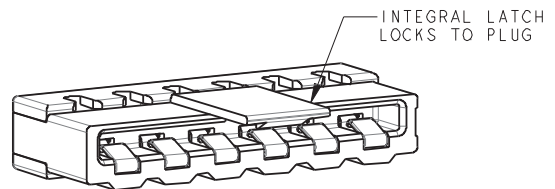
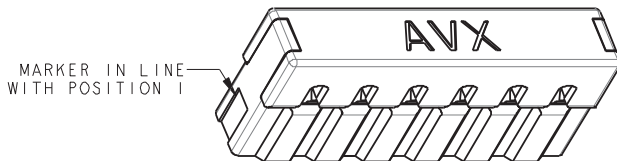

PACKING DETAILS CAP AND CONNECTOR SUPPLIED TOGETHER (2 PARTS)

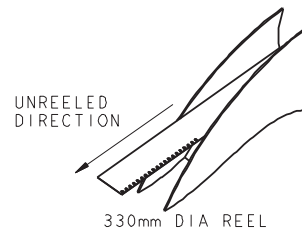
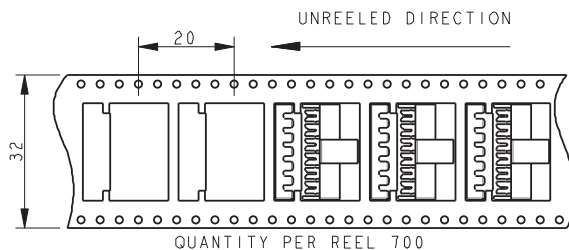

SOCKET-WIRED – 2 WAY WIRE STOP CAP

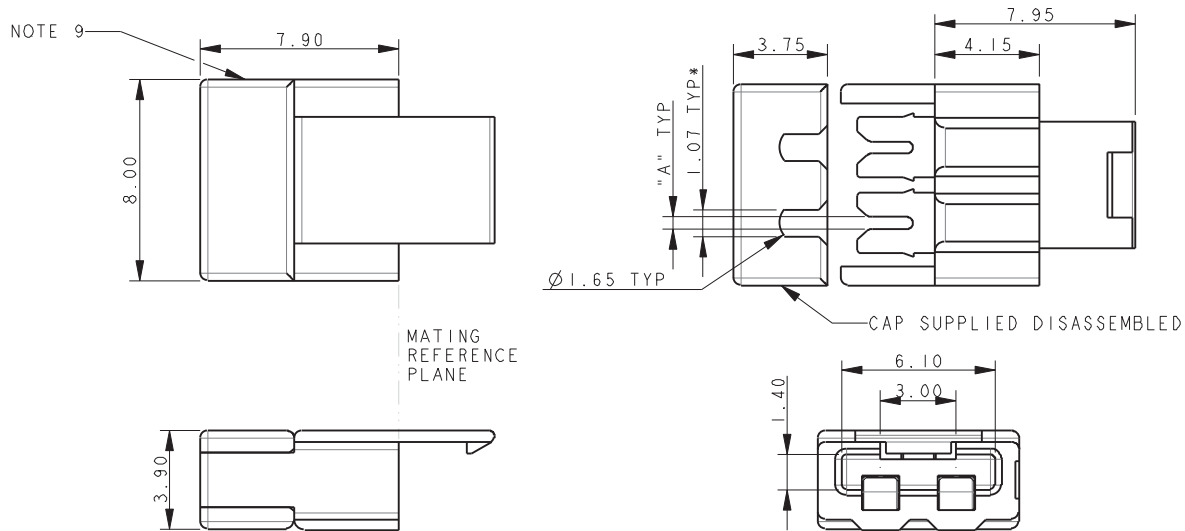

NOTES:

- FOR MORE INFORMATION REFER TO PRODUCT SPEC 201-01-119.
FOR WIRE ASSEMBLY REFER TO APPLICATION NOTES 201-01-123.
- WIRE STOP CAP, WITH STOP FACE ON ONE SIDE TO PROTECT END OF WIRE.
- CAP ACTS AS WIRE ASSEMBLY TOOL. WIRE PREFIT TO CAP, NARROW SLOT TO GRIP WIRE, PERMANENT ASSEMBLY.
- GENERAL TOLERANCE ± 0.20 UNLESS SPECIFIED.
- INSULATOR MATERIAL: NYLON 46, GLASS FILLED, UL94 V-0. COLOR REFER TO PAGE 1.
- CONTACT MATERIAL: COPPER ALLOY, PLATING NICKEL BASE ALL OVER, GOLD ON CONTACT, TIN ON IDC.
- PACKING IN TAPE AND REEL. QTY PER REEL 700, POCKET CONTAINS 1 CONNECTOR AND 1 CAP.
- WIRE GAUGE OPTIONS, SEE TABLE.
- SHOWN WITH WIRE ENTRY FROM UNDERSIDE, CAP CAN BE ASSEMBLED FOR EITHER TOP OR UNDERSIDE WIRE ENTRY.
- ASSEMBLY AIDS, REFER TO PAGE 12.

Wire Gauge	Code (page 1)	Dimension A	Wire Insulation Diameter
22AWG (Stranded Wire)	122	0.47	1.10 to 1.60
24AWG (Stranded Wire)	132	0.37	1.10 to 1.60

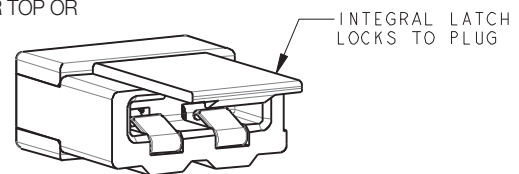
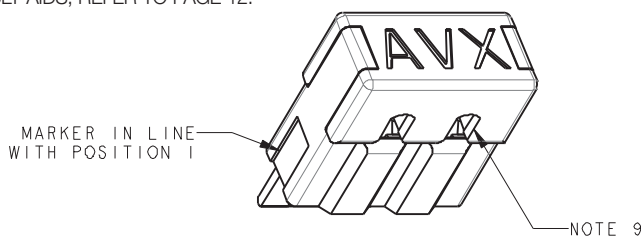

PACKING DETAILS CAP AND CONNECTOR SUPPLIED TOGETHER (2 PARTS)

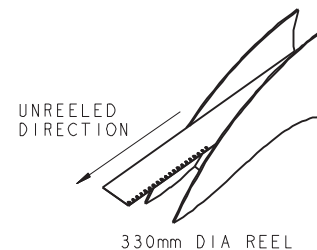
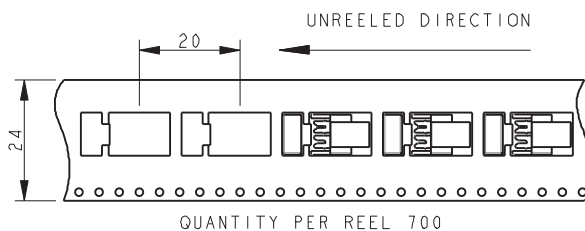

SOCKET-WIRED – 3 WAY WIRE STOP CAP

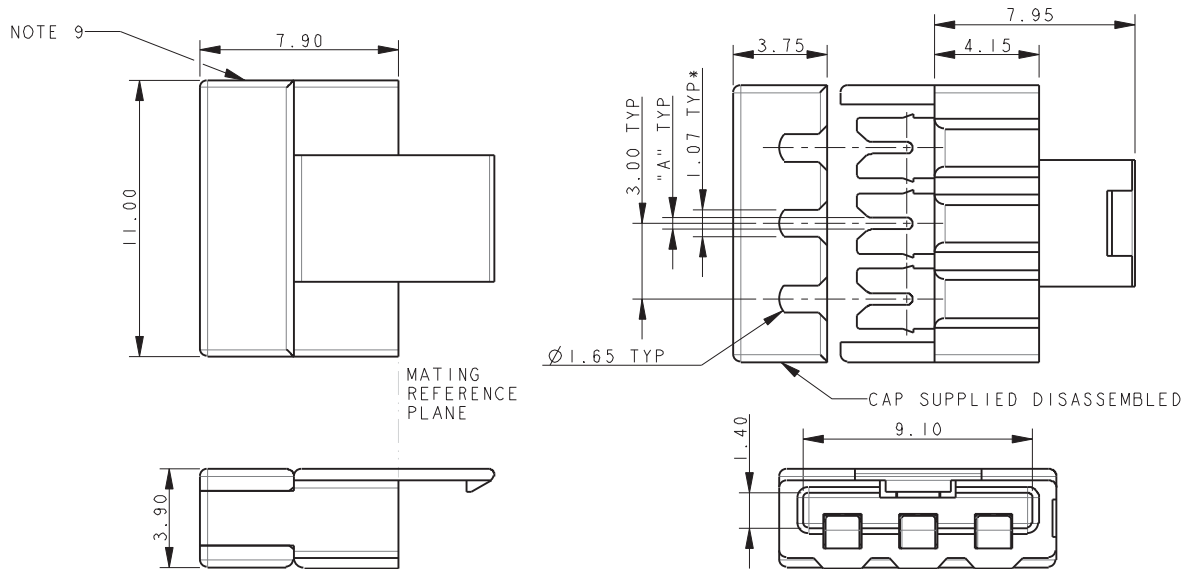

NOTES:

1. FOR MORE INFORMATION REFER TO PRODUCT SPEC 201-01-119.
FOR WIRE ASSEMBLY REFER TO APPLICATION NOTES 201-01-123.
2. WIRE STOP CAP, WITH STOP FACE ON ONE SIDE TO PROTECT END OF WIRE.
3. CAP ACTS AS WIRE ASSEMBLY TOOL. WIRE PREFIT TO CAP, NARROW SLOT TO GRIP WIRE, PERMANENT ASSEMBLY.
4. GENERAL TOLERANCE ± 0.20 UNLESS SPECIFIED.
5. INSULATOR MATERIAL: NYLON 46, GLASS FILLED, UL94 V-0. COLOR REFER TO PAGE 1.
6. CONTACT MATERIAL: COPPER ALLOY, PLATING NICKEL BASE ALL OVER, GOLD ON CONTACT, TIN ON IDC.
7. PACKING IN TAPE AND REEL. QTY PER REEL 700, POCKET CONTAINS 1 CONNECTOR AND 1 CAP.
8. WIRE GAUGE OPTIONS, SEE TABLE.
9. SHOWN WITH WIRE ENTRY FROM UNDERSIDE, CAP CAN BE ASSEMBLED FOR EITHER TOP OR UNDERSIDE WIRE ENTRY.
10. ASSEMBLY AIDS, REFER TO PAGE 12.

Wire Gauge	Code (page 1)	Dimension A	Wire Insulation Diameter
22AWG (Stranded Wire)	122	0.47	1.10 to 1.60
24AWG (Stranded Wire)	132	0.37	1.10 to 1.60

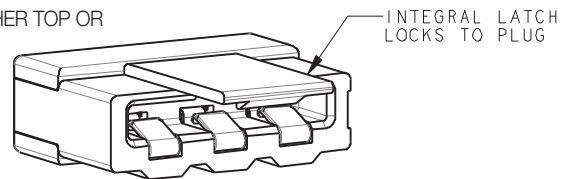
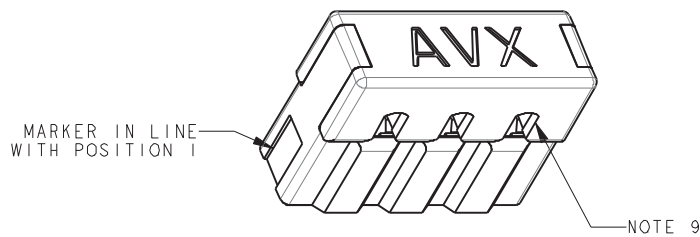

PACKING DETAILS CAP AND CONNECTOR SUPPLIED TOGETHER (2 PARTS)

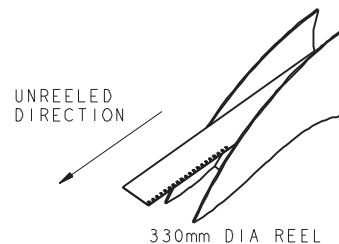
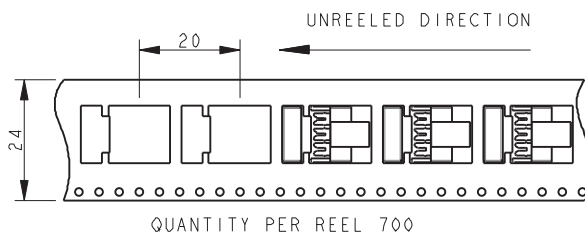

SOCKET-WIRED – 4 WAY WIRE STOP CAP

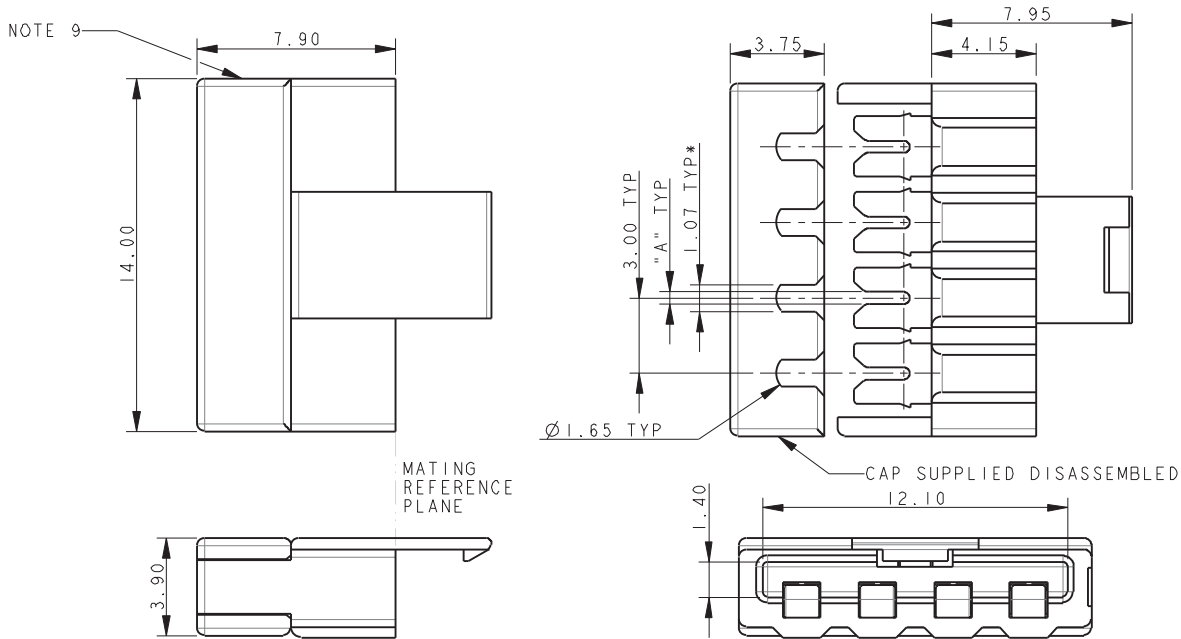

NOTES:

1. FOR MORE INFORMATION REFER TO PRODUCT SPEC 201-01-119.
FOR WIRE ASSEMBLY REFER TO APPLICATION NOTES 201-01-123.
2. WIRE STOP CAP, WITH STOP FACE ON ONE SIDE TO PROTECT END OF WIRE.
3. CAP ACTS AS WIRE ASSEMBLY TOOL. WIRE PREFIT TO CAP, NARROW SLOT TO GRIP WIRE, PERMANENT ASSEMBLY.
4. GENERAL TOLERANCE ± 0.20 UNLESS SPECIFIED.
5. INSULATOR MATERIAL: NYLON 46, GLASS FILLED, UL94 V-0. COLOR REFER TO PAGE 1.
6. CONTACT MATERIAL: COPPER ALLOY, PLATING NICKEL BASE ALL OVER, GOLD ON CONTACT, TIN ON IDC.
7. PACKING IN TAPE AND REEL. QTY PER REEL 700, POCKET CONTAINS 1 CONNECTOR AND 1 CAP.
8. WIRE GAUGE OPTIONS, SEE TABLE.
9. SHOWN WITH WIRE ENTRY FROM UNDERSIDE, CAP CAN BE ASSEMBLED FOR EITHER TOP OR UNDERSIDE WIRE ENTRY.
10. ASSEMBLY AIDS, REFER TO PAGE 12.

Wire Gauge	Code (page 1)	Dimension A	Wire Insulation Diameter
22AWG (Stranded Wire)	122	0.47	1.10 to 1.60
24AWG (Stranded Wire)	132	0.37	1.10 to 1.60

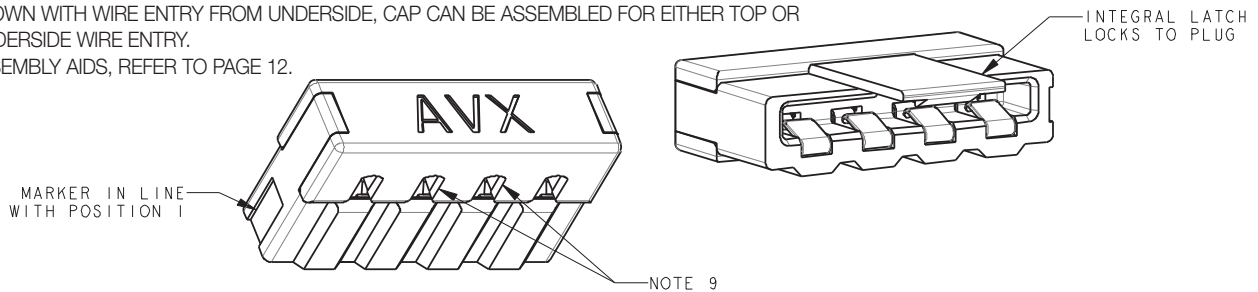

PACKING DETAILS CAP AND CONNECTOR SUPPLIED TOGETHER (2 PARTS)

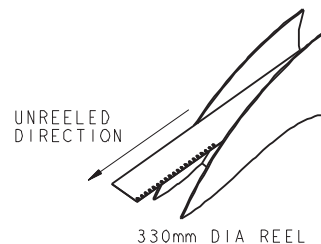
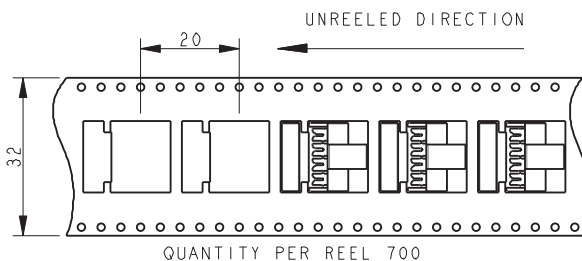

SOCKET-WIRED – 5 WAY WIRE STOP CAP

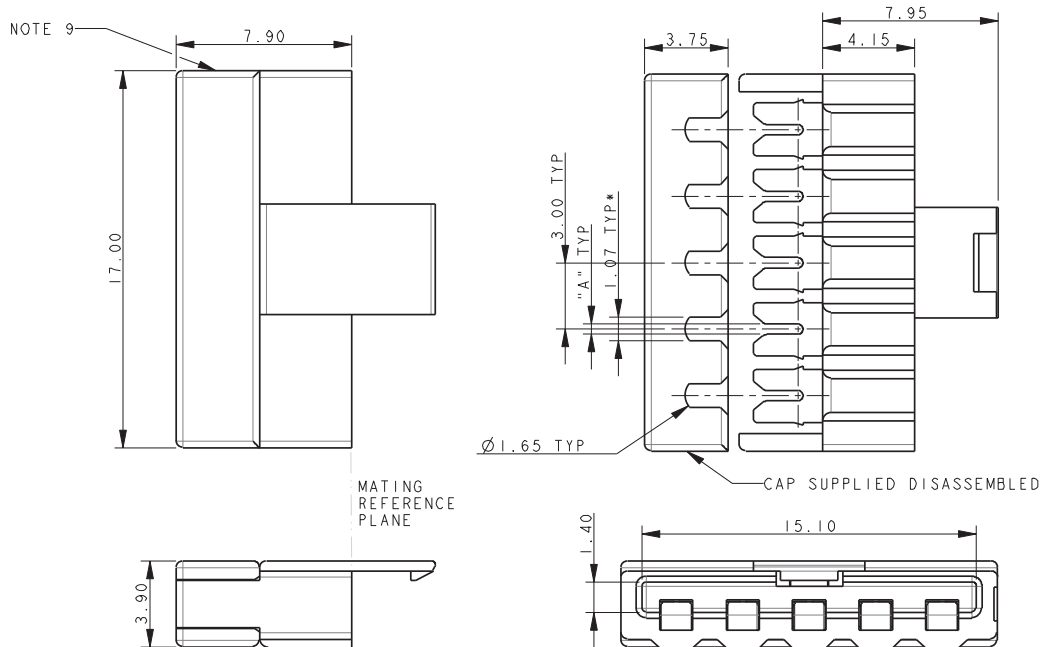

NOTES:

1. FOR MORE INFORMATION REFER TO PRODUCT SPEC 201-01-119.
FOR WIRE ASSEMBLY REFER TO APPLICATION NOTES 201-01-123.
2. WIRE STOP CAP, WITH STOP FACE ON ONE SIDE TO PROTECT END OF WIRE.
3. CAP ACTS AS WIRE ASSEMBLY TOOL. WIRE PREFIT TO CAP, NARROW SLOT TO GRIP WIRE, PERMANENT ASSEMBLY.
4. GENERAL TOLERANCE ± 0.20 UNLESS SPECIFIED.
5. INSULATOR MATERIAL: NYLON 46, GLASS FILLED, UL94 V-0. COLOR REFER TO PAGE 1.
6. CONTACT MATERIAL: COPPER ALLOY, PLATING NICKEL BASE ALL OVER, GOLD ON CONTACT, TIN ON IDC.
7. PACKING IN TAPE AND REEL. QTY PER REEL 700, POCKET CONTAINS 1 CONNECTOR AND 1 CAP.
8. WIRE GAUGE OPTIONS, SEE TABLE.
9. SHOWN WITH WIRE ENTRY FROM UNDERSIDE, CAP CAN BE ASSEMBLED FOR EITHER TOP OR UNDERSIDE WIRE ENTRY.
10. ASSEMBLY AIDS, REFER TO PAGE 12.

Wire Gauge	Code (page 1)	Dimension A	Wire Insulation Diameter
22AWG (Stranded Wire)	122	0.47	1.10 to 1.60
24AWG (Stranded Wire)	132	0.37	1.10 to 1.60

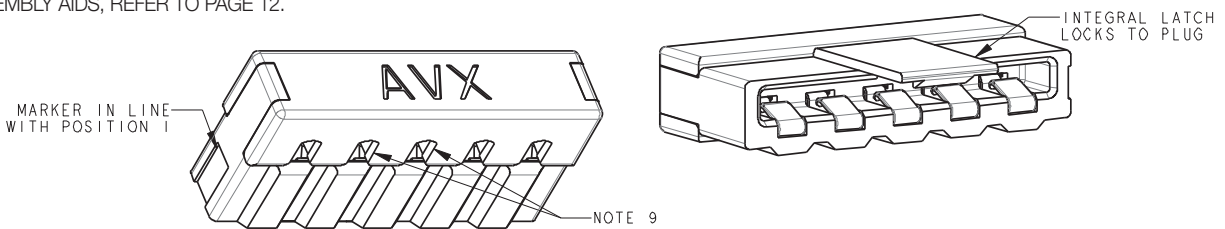

PACKING DETAILS CAP AND CONNECTOR SUPPLIED TOGETHER (2 PARTS)

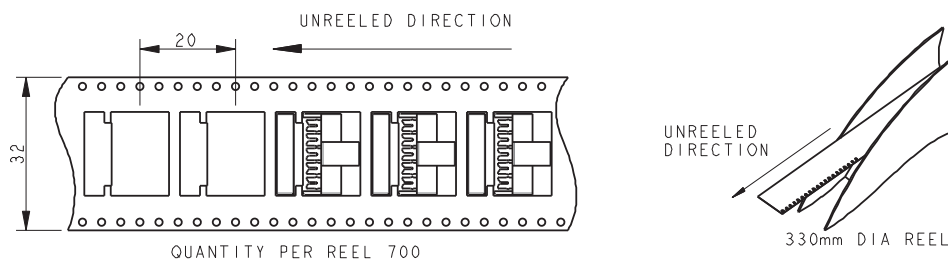

SOCKET-WIRED – 6 WAY WIRE STOP CAP

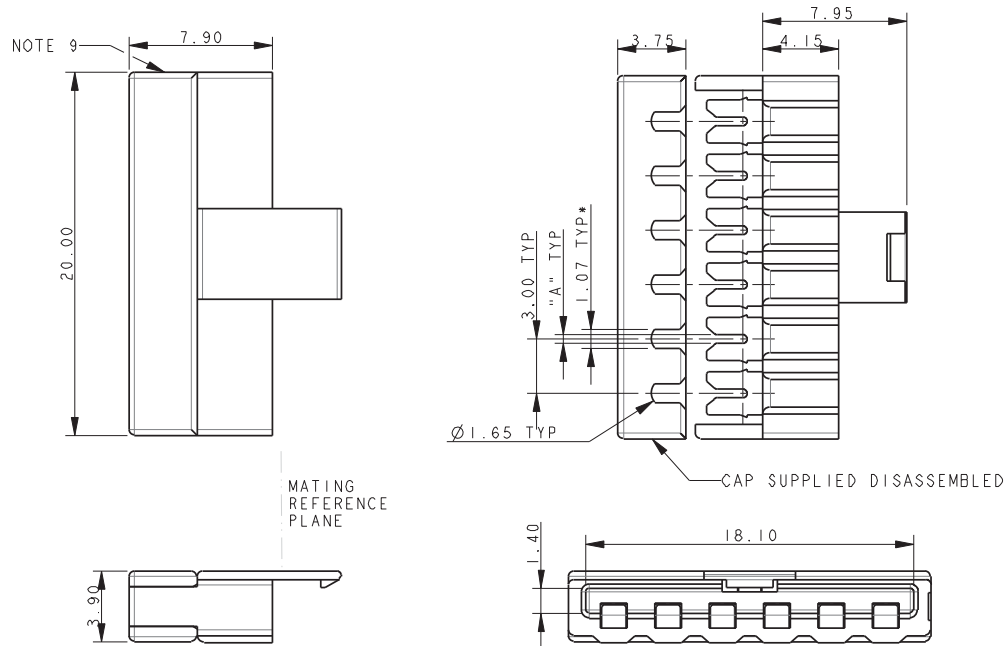

NOTES:

1. FOR MORE INFORMATION REFER TO PRODUCT SPEC 201-01-119.
FOR WIRE ASSEMBLY REFER TO APPLICATION NOTES 201-01-123.
2. WIRE STOP CAP, WITH STOP FACE ON ONE SIDE TO PROTECT END OF WIRE.
3. CAP ACTS AS WIRE ASSEMBLY TOOL. WIRE PREFIT TO CAP, NARROW SLOT TO GRIP WIRE, PERMANENT ASSEMBLY.
4. GENERAL TOLERANCE ± 0.20 UNLESS SPECIFIED.
5. INSULATOR MATERIAL: NYLON 46, GLASS FILLED, UL94 V-0. COLOR REFER TO PAGE 1.
6. CONTACT MATERIAL: COPPER ALLOY, PLATING NICKEL BASE ALL OVER, GOLD ON CONTACT, TIN ON IDC.
7. PACKING IN TAPE AND REEL. QTY PER REEL 700, POCKET CONTAINS 1 CONNECTOR AND 1 CAP.
8. WIRE GAUGE OPTIONS, SEE TABLE.
9. SHOWN WITH WIRE ENTRY FROM UNDERSIDE, CAP CAN BE ASSEMBLED FOR EITHER TOP OR UNDERSIDE WIRE ENTRY.
10. ASSEMBLY AIDS, REFER TO PAGE 12.

Wire Gauge	Code (page 1)	Dimension A	Wire Insulation Diameter
22AWG (Stranded Wire)	122	0.47	1.10 to 1.60
24AWG (Stranded Wire)	132	0.37	1.10 to 1.60

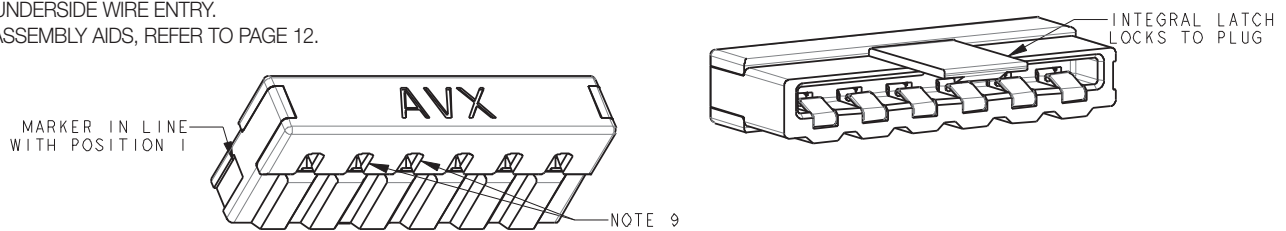

PACKING DETAILS CAP AND CONNECTOR SUPPLIED TOGETHER (2 PARTS)

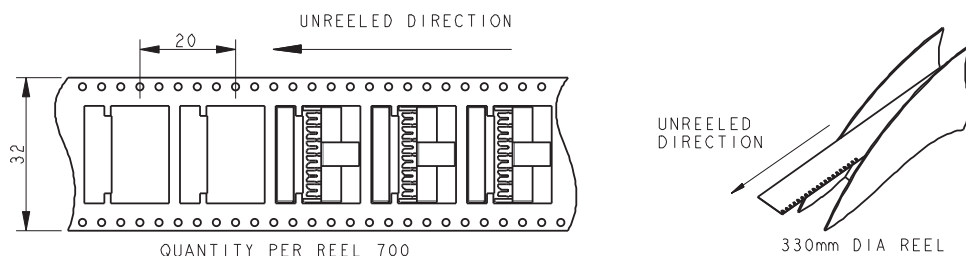

SOCKET-WIRED – ASSEMBLY SUPPORT BLOCK

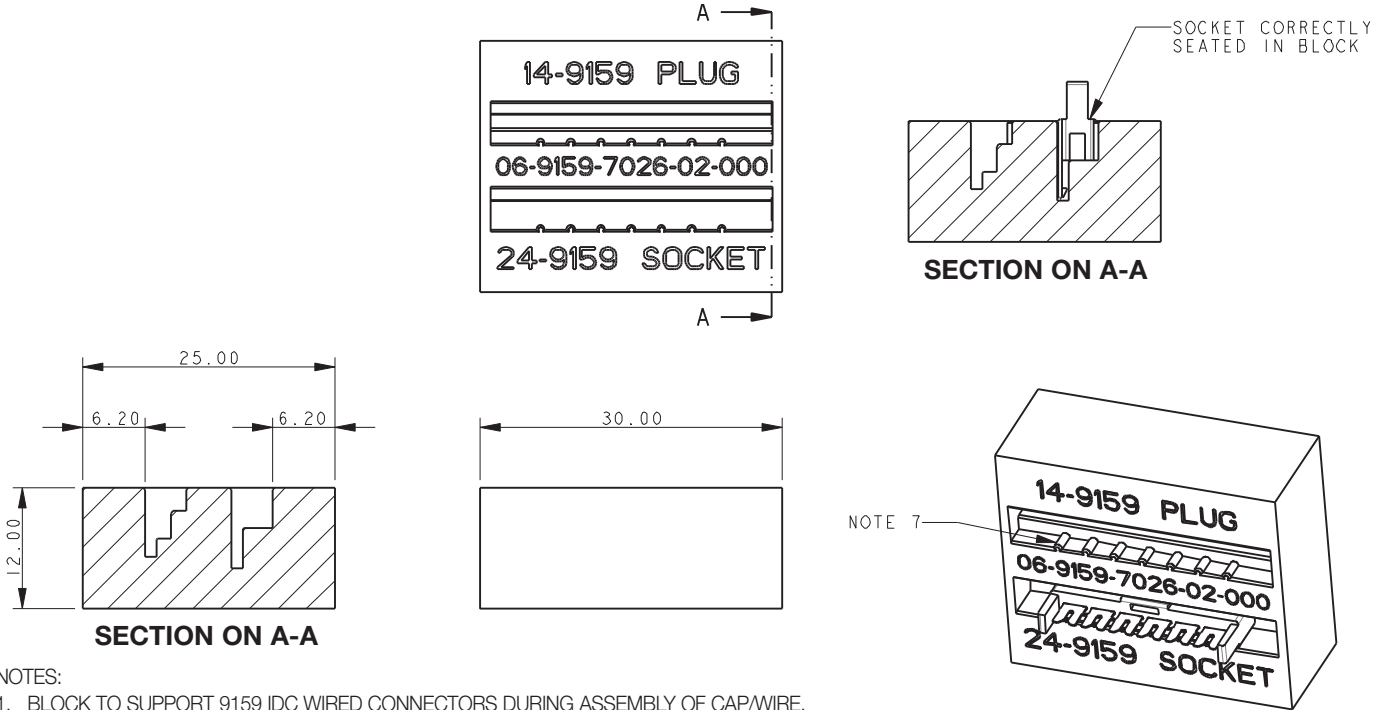

NOTES:

1. BLOCK TO SUPPORT 9159 IDC WIRED CONNECTORS DURING ASSEMBLY OF CAP/WIRE.
2. PART NUMBER 06-9159-7026-01-000, MATERIAL ALUMINUM.
PART NUMBER 06-9159-7026-02-000, MATERIAL NYLON 46.
3. CAN BE USED WITH EITHER THE PLUG OR SOCKET CONNECTORS, USE THE CORRECT SLOT AS IDENTIFIED.
4. FOR FULL WIRE ASSEMBLY DETAILS REFER TO APPLICATION NOTES 201-01-123.
5. ONLY A SIMPLE FLAT BOTTOMED TOOL REQUIRED TO PUSH THE CAP DOWN (NOT SUPPLIED.)
6. ALL DIMENSIONS ± 0.20 UNLESS TOLERANCED.
7. 06-9159-7026-02-000 HAS RIBS TO HELP LOCATE CONTACT/INSULATOR SUB-ASSEMBLY.

SOCKET-WIRED – WIRE INSERTION TOOL

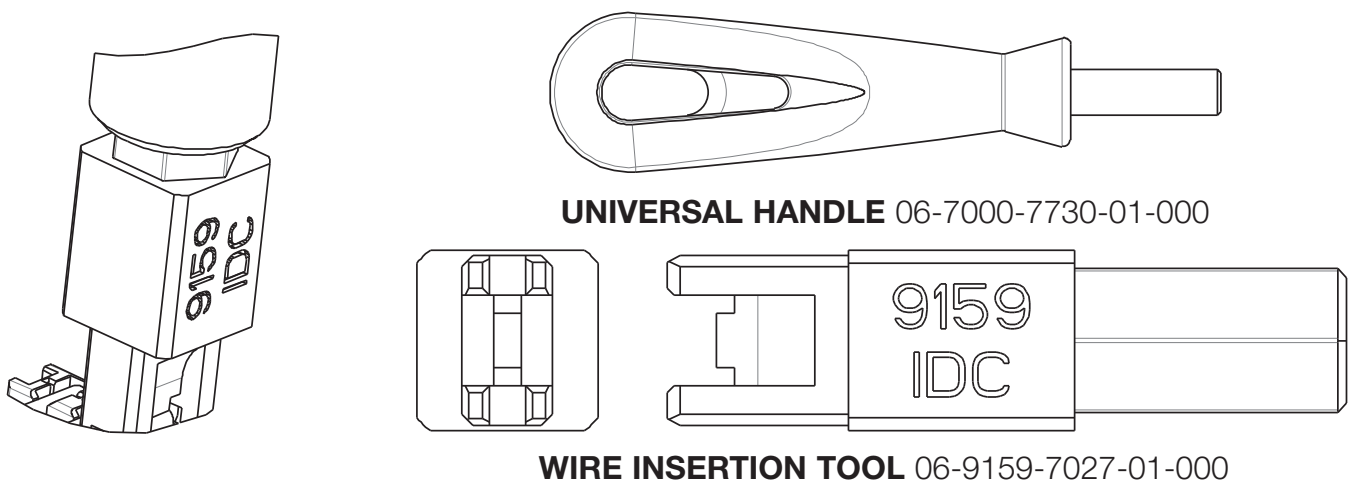

NOTES:

1. TOOL 06-9159-7027-01-000 TO INSERT WIRES INTO CAP.
2. FOR USE WITH UNIVERSAL HANDLE 06-7000-7720-01-000.
3. CAN BE USED WITH BOTH THROUGH WIRE AND WIRE STOP CAPS.
4. REFER TO APPLICATION NOTES 201-01-123 FOR FURTHER DETAILS.

SOCKET-WIRED – ASSEMBLY

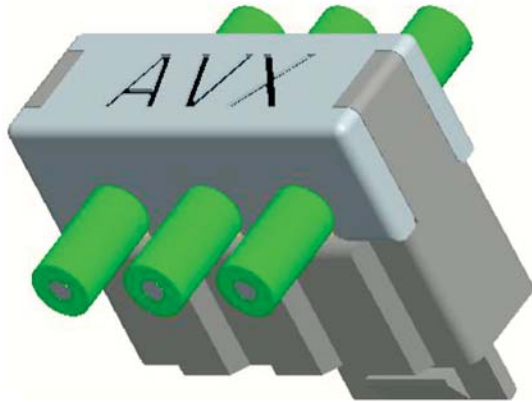

THROUGH WIRE

**WIRED STOP
WIRE ENTRY UNDERSIDE**

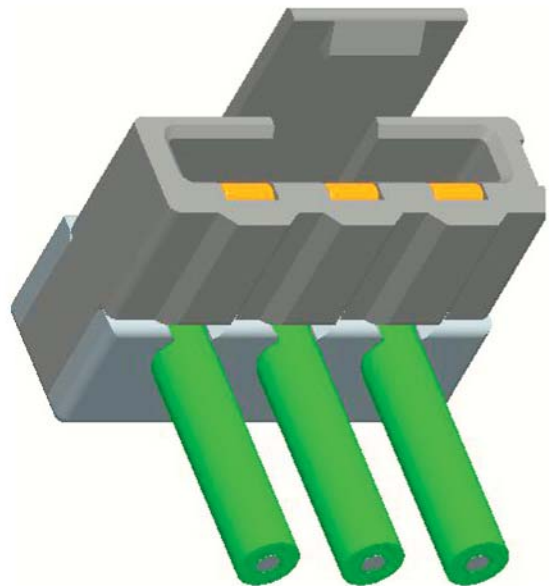

**WIRED STOP
WIRE ENTRY TOP**

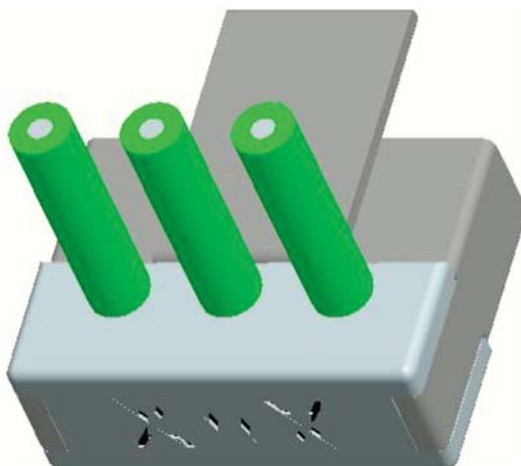



Компания «ЭлектроПласт» предлагает заключение долгосрочных отношений при поставках импортных электронных компонентов на взаимовыгодных условиях!

Наши преимущества:

- Оперативные поставки широкого спектра электронных компонентов отечественного и импортного производства напрямую от производителей и с крупнейших мировых складов;
- Поставка более 17-ти миллионов наименований электронных компонентов;
- Поставка сложных, дефицитных, либо снятых с производства позиций;
- Оперативные сроки поставки под заказ (от 5 рабочих дней);
- Экспресс доставка в любую точку России;
- Техническая поддержка проекта, помощь в подборе аналогов, поставка прототипов;
- Система менеджмента качества сертифицирована по Международному стандарту ISO 9001;
- Лицензия ФСБ на осуществление работ с использованием сведений, составляющих государственную тайну;
- Поставка специализированных компонентов (Xilinx, Altera, Analog Devices, Intersil, Interpoint, Microsemi, Aeroflex, Peregrine, Syfer, Eurofarad, Texas Instrument, Miteq, Cobham, E2V, MA-COM, Hittite, Mini-Circuits, General Dynamics и др.);

Помимо этого, одним из направлений компании «ЭлектроПласт» является направление «Источники питания». Мы предлагаем Вам помощь Конструкторского отдела:

- Подбор оптимального решения, техническое обоснование при выборе компонента;
- Подбор аналогов;
- Консультации по применению компонента;
- Поставка образцов и прототипов;
- Техническая поддержка проекта;
- Защита от снятия компонента с производства.



Как с нами связаться

Телефон: 8 (812) 309 58 32 (многоканальный)

Факс: 8 (812) 320-02-42

Электронная почта: org@eplast1.ru

Адрес: 198099, г. Санкт-Петербург, ул. Калинина, дом 2, корпус 4, литера А.