

Table of Contents

AMP multifitting Mark II

Introduction2002
 Direct and Indirect Connection 5.0mm Centerline.....2003
 Derating Curves2004
 Keying Plan and Cable Exit2005
 Technical Features2006
 Direct Mating Connector System2007, 2008
 Indirect Mating Connector System.....2009-2011
 PC Board Frame2012

AMP MONO-SHAPE

Introduction2013
 Connector Versions2014
 Tab Connectors2015
 Tab Connectors Keying Plan2016
 Tab Connector 3-10 Positions2017-2020
 Single Way Connectors2021
 Single Way Connectors Keying Plan2022
 PCB Connectors2023-2027
 Satellite Connectors2028
 Satellite Connectors Keying Plan2029
 Bridge Connectors Keying Plan2030

AMP MONO-SHAPE Mark II

Introduction2031
 Technical Data2032
 Keying Plan and Cable Exit2033
 Tab Connector System2034-2035
 TAB-BRIDGE Connector System - Short Circuit2036
 PCB Connector System2037-2041
 Application Tooling2042-2045

Standard Timer

Introduction 2046
 Interior and Exterior Locking2047
 Keying Plan2048
 Housings2049-2059
 Connectors and Contacts2060

2
Rast 5

Introduction

Product Features

- Direct Mating Connectors for PC Boards, 2–8 Positions, up to 6 A Current Carrying Capacity
- Indirect Mating Connectors, 1–8 Positions, up to 16 A Current Carrying Capacity
- Variable Keying
- Double Wire Termination possible

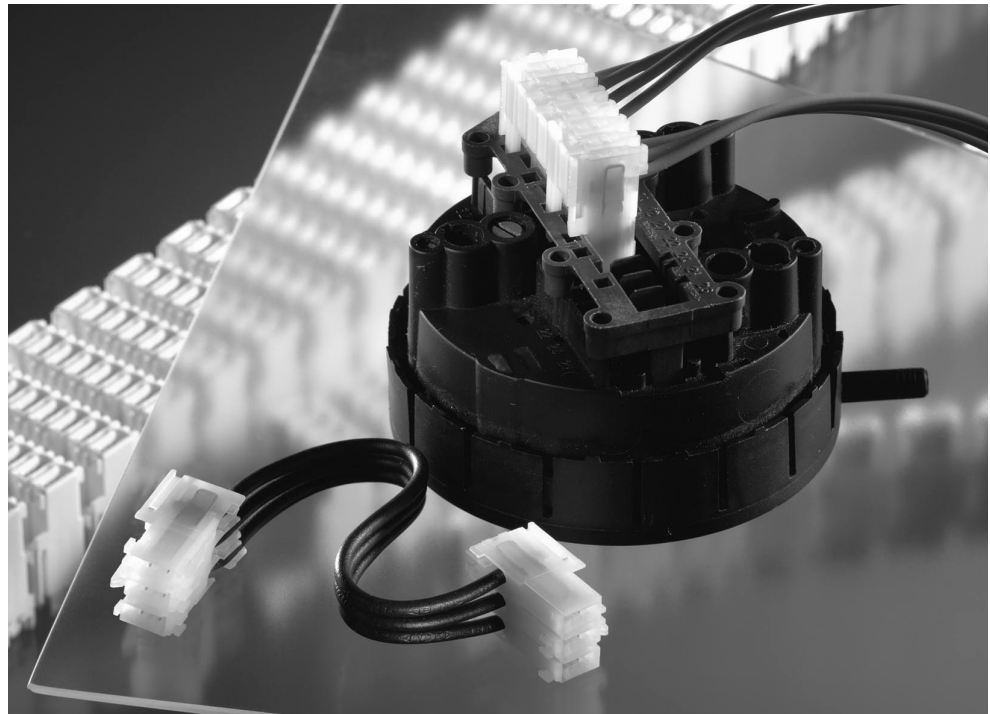

Tyco Electronics' newly designed AMP multifitting Mark II Connector System was developed according to the latest connector design standards.

The requirements of advanced In-Line mating technology for the components and contacts of pc boards are incorporated in the direct and indirect versions of these connector systems.

This system is suitable for a wide wire size range. Current carrying capacity is 16 A maximum.

Double termination is possible with 0.5 and 0.5 mm² or 0.5 and 0.75 mm² conductors.

The connectors are available in 1- to 8-positions (indirect) resp. 2- to 8-positions (direct) with an exterior locking device.

Interior locking options are available on request.

Supplied in chain and provided with all keying and polarisation ribs, the connectors can be operated economically with modern Application Tooling Equipment.

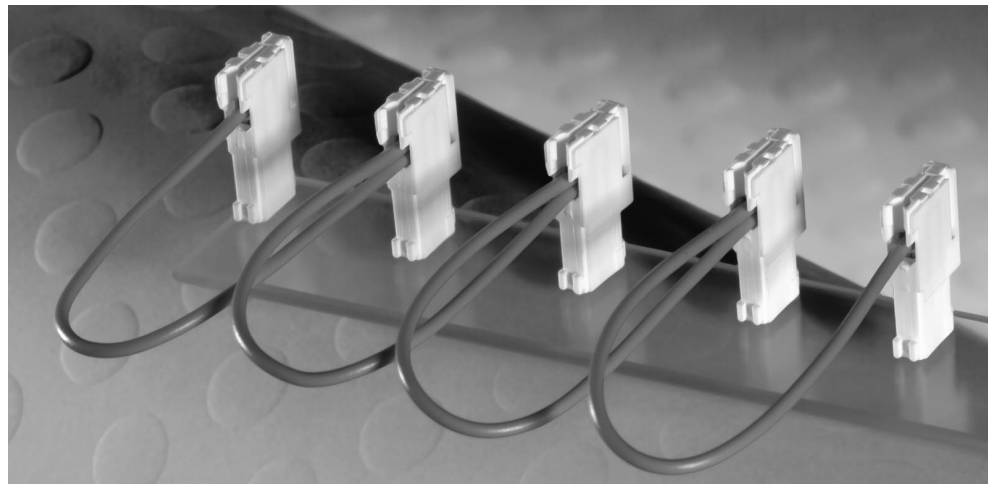

Direct and Indirect Mating Connection, 5.0 mm Centerline

2
Rast 5

Direct Mating Connection, 5.0 mm Centerline

- 1 Double Wire Exit
- 2 Wire Exit 90°
- 3 Wire Exit 180°
- 4 Cover
- 5 Exterior Locking Latch
- 6 Keying
- 7 Polarisation

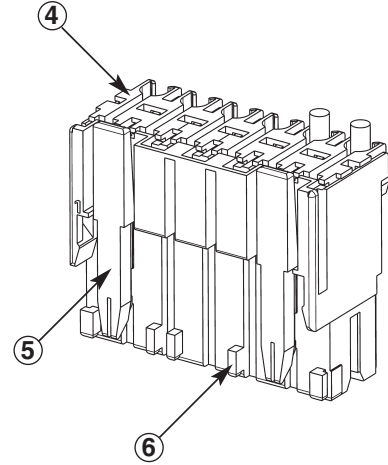
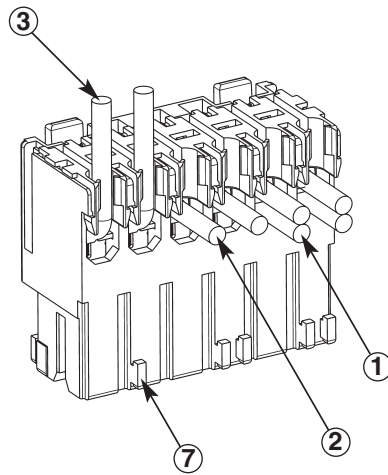

Indirect Mating Connection, 5.0 mm Centerline

- 1 Double Wire Exit
- 2 Wire Exit 90°
- 3 Wire Exit 180°
- 4 Cover
- 5 Exterior Locking Latch
- 6 Keying
- 7 Polarisation

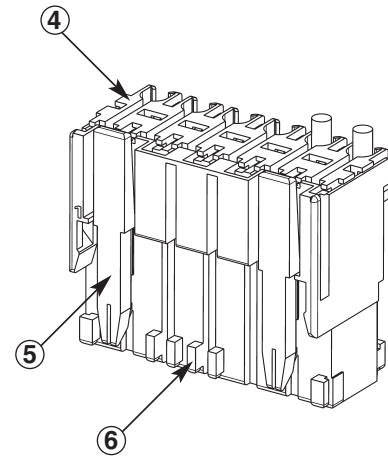
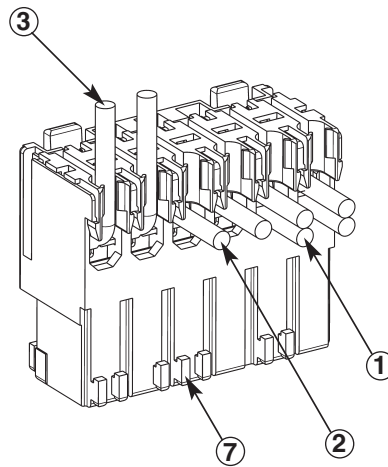

Indirect Mating Connection with Interior Locking, 5.0 mm Centerline

- 1 Double Wire Exit
- 2 Wire Exit 90°
- 3 Wire Exit 180°
- 4 Cover
- 5 Interior Locking Latch
- 6 Keying
- 7 Polarisation

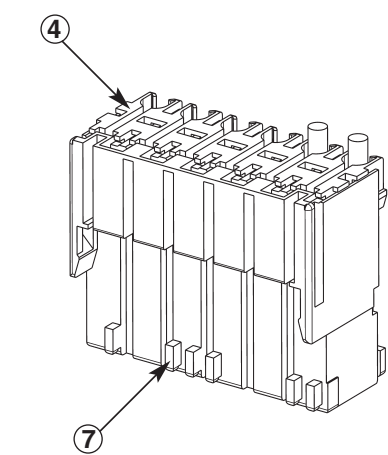
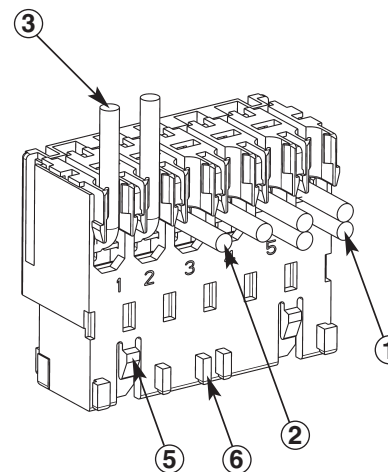

Derating Curves

Direct Mating Connector System

Connector:

8 positions

Material:

Brass, tin plated

Wire:

0.5 mm²

PC Board:

FR4, 2 x 0.35 µm Copper, tin plated

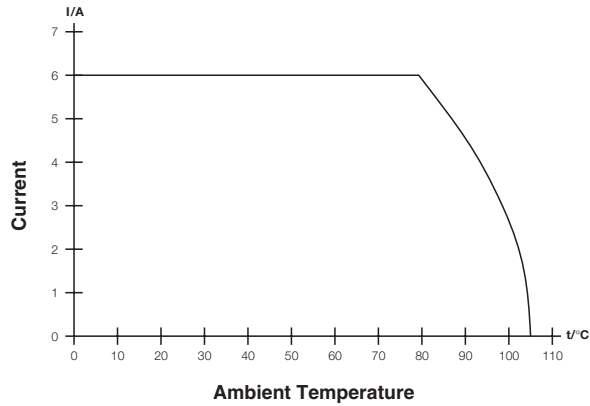

Indirect Mating Connector System

Material:

Brass, tin plated

Wire:

0.5 mm² (Curve 1 and 2)
1.0 mm² (Curve 3)

Mating Part:

6.3 x 0.8 mm Tab, Brass, tin plated

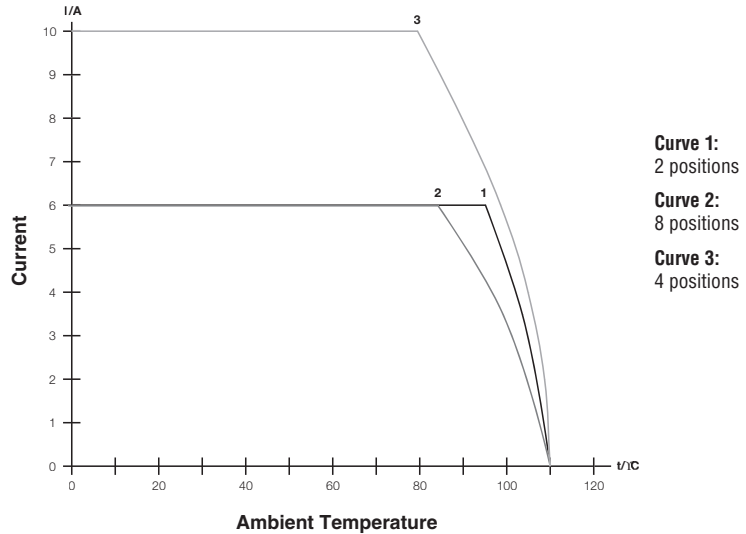

Indirect Mating Connector System

Material:

CuNi2Si, silver plated

Wire:

1.5 mm², tin plated

Mating Part:

6.3 x 0.8 mm Tab, Brass, tin plated

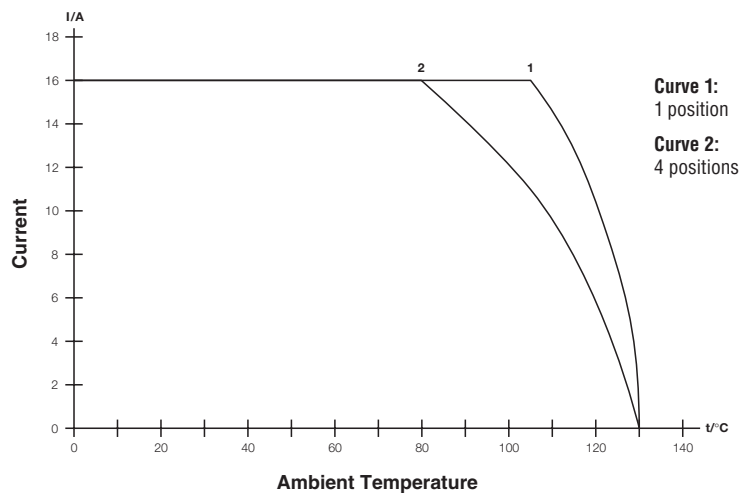

Keying Plan and Cable Exit

Keying Plan from Mating Direction, Fully-Keyed Version

- 1 Locking Latch
- 2 Keying Rib
- 3 Polarisisation Rib
- 4 Cavity Number

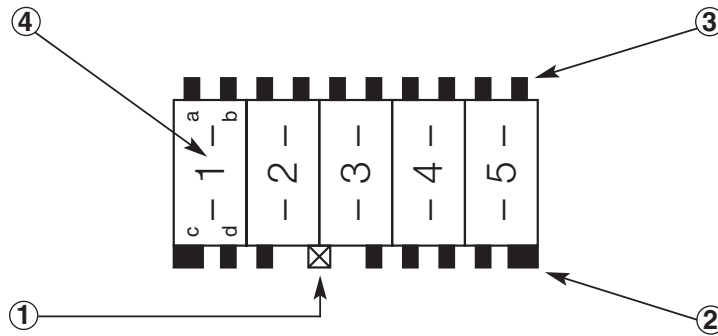

Keyed Version: 05-C according RAST 5

This final keying version will be produced on the Application Tooling Equipment.

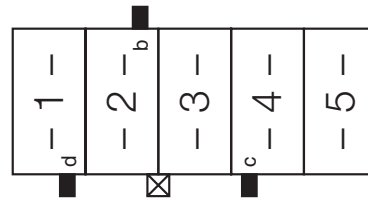

Cable Exit with Interior and Exterior Locking

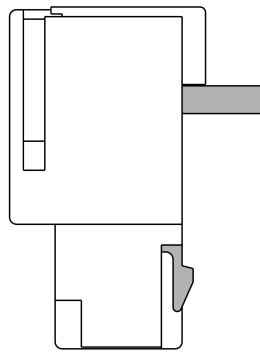

Cable Exit with Interior Locking

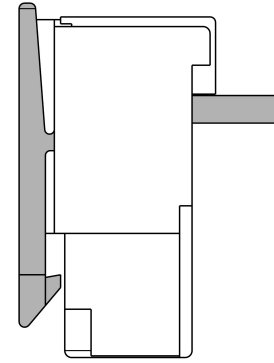

Cable Exit with Exterior Locking

Direct Mating of a PCB with PC Board Frames

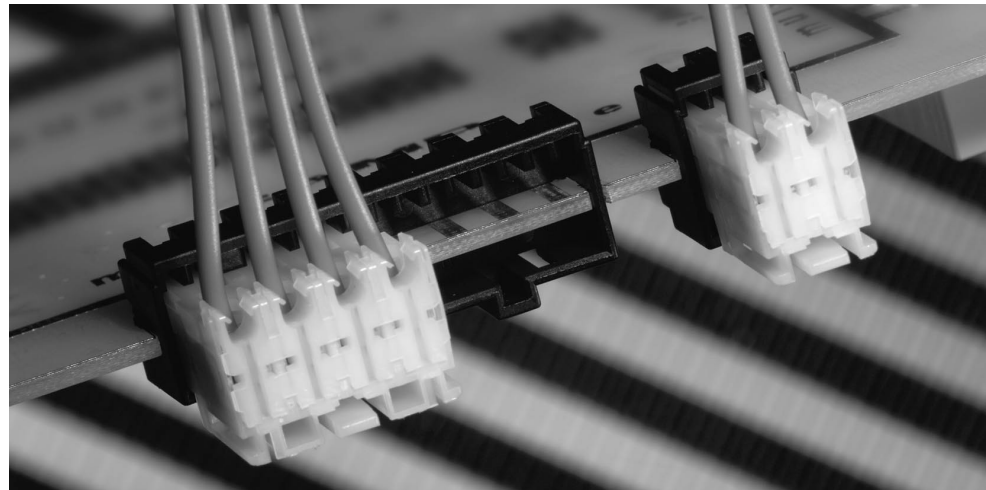

Technical Features

Technical Data

- Centerline:**
5.0 mm
- Housing Material:**
Polyamide, PA 6.6 and PA 6
- Standard Colour:**
Natural
- Current Voltage:**
250 V ≈
- Air and Creepage Distance:**
>3.2 mm
- Flammability Rating:**
UL 94 V-2
- Approvals:**
VDE, UL

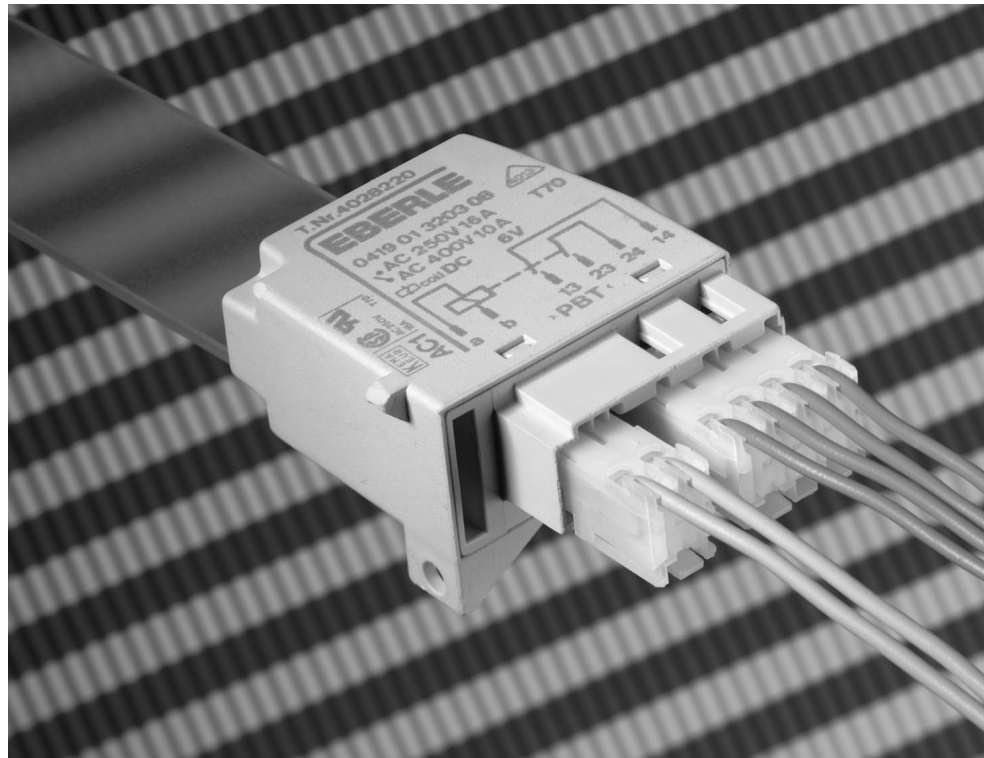

Direct Mating Connectors

- No. of Positions:**
2- to 8-positions
 - Contact Material:**
Brass
 - Contact Finish:**
Tin plated
 - Wire Size Range:**
0.35–1.0 mm²
 - Temperature Range:**
–40 °C up to +105 °C
 - Current Rating:**
6 A max.
 - Insulation Diameter:**
2.8 mm max.
 - Insulation Resistance:**
>10 MΩ
 - Mating Force:**
≤7 N per contact *
 - Unmating Force:**
≥1.5 N *
 - Product Specification:**
108-18653
 - Application Specification:**
114-18289
- *) measured with polished steel plate 1.5 mm thickness

Indirect Mating Connectors

- No. of Positions:**
1- to 8-positions
 - Contact Material:**
Brass / CuNi2Si
 - Contact Finish:**
Tin plated / silver plated
 - Wire Size Range:**
0.35–1.0 mm² / 1.0–1.5 mm²
 - Temperature Range:**
–40 °C up to +130 °C
 - Current Rating:**
10 A, up to 4 contacts 16 A
 - Insulation Diameter:**
3.0 mm max.
 - Insulation Resistance:**
>10 MΩ
 - Mating Force:**
≤6.5 N per contact **
 - Unmating Force:**
≥1.5 N **
 - Product Specification:**
108-18652
 - Application Specification:**
114-18288, 114-18382
- ***) measured with polished steel tab 6.3 x 0.8 mm

Direct Mating Connector System

Technical Data

Wire Size Range:
0.35–1.0 mm²

Current Carrying Capacity (max.):
6 A

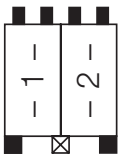
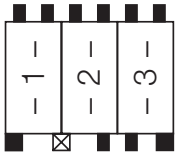
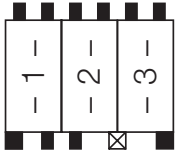
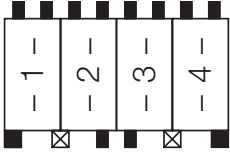
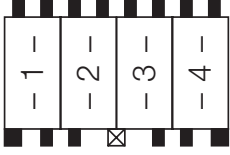
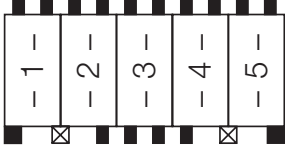
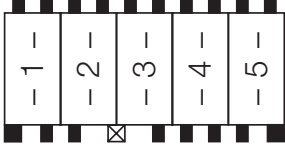
| RAST 5 Version | Part Numbers with Exterior Locking | | Package Quantity | Part Numbers with Interior Locking | |
|---|------------------------------------|-------------|------------------|------------------------------------|--------|
| | PA 6.6 | PA 6 * | | PA 6.6 | PA 6 * |
|  | 1241172-2 | 1534075-2 | 4,900 | - | - |
|  | 1241172-3 | 1534075-3 | 3,136 | - | - |
|  | 1-1241172-3 | 1-1534075-3 | 3,136 | - | - |
|  | 1241172-4 | 1534075-4 | 2,352 | - | - |
|  | 1-1241172-4 | 1-1534075-4 | 2,352 | - | - |
|  | 1241172-5 | 1534075-5 | 1,960 | - | - |
|  | 1-1241172-5 | 1-1534075-5 | 1,960 | - | - |

*)According to IEC 60695-2-1/1; GWT (Glow Wire Test) 750 °C without flame, see VDE M-Test Report.
The final keying version will be produced on the Application Tooling Equipment.

Direct Mating Connector System (continued)

Technical Data

Wire Size Range:
0.35–1.0 mm²

Current Carrying Capacity (max.):
6 A

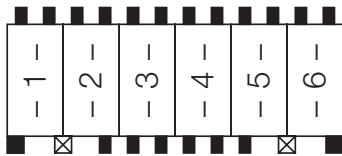
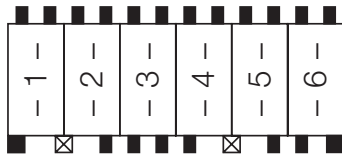
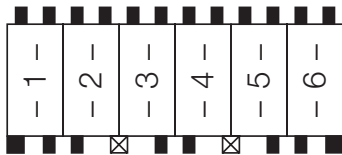
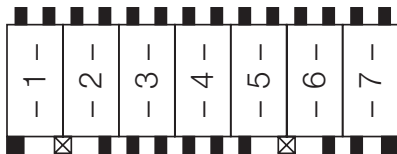
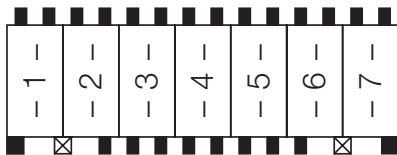
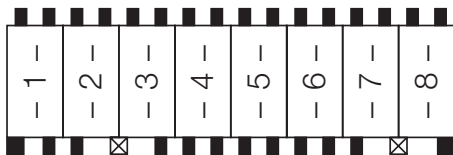
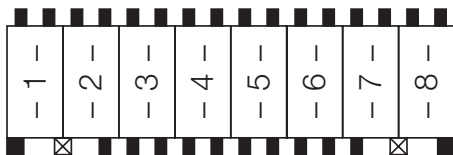
| RAST 5 Version | Part Numbers with Exterior Locking | | Package Quantity | Part Numbers with Interior Locking | |
|---|------------------------------------|-------------|------------------|------------------------------------|-------|
| | PA 6.6 | PA 6* | | PA 6.6 | PA 6* |
|  | 1241172-6 | 1534075-6 | 1,568 | - | - |
|  | 1-1241172-6 | 1-1534075-6 | 1,568 | - | - |
|  | 2-1241172-6 | 2-1534075-6 | 1,568 | - | - |
|  | 1241172-7 | 1534075-7 | 1,372 | - | - |
|  | 1-1241172-7 | 1-1534075-7 | 1,372 | - | - |
|  | 1241172-8 | 1534075-8 | 1,176 | - | - |
|  | 1-1241172-8 | 1-1534075-8 | 1,176 | - | - |

*)According to IEC 60695-2-1/1; GWT (Glow Wire Test) 750 °C without flame, see VDE M-Test Report.
The final keying version will be produced on the Application Tooling Equipment.

Indirect Mating Connector System

Technical Data

Wire Size Range:
0.35–1.0 mm²

Current Carrying Capacity
(max.):
10 A

| RAST 5 Version | Part Numbers with Exterior Locking | | Package Quantity | Part Numbers with Interior Locking | |
|----------------|------------------------------------|-------------|------------------|------------------------------------|-------------|
| | PA 6.6 | PA 6* | | PA 6.6 | PA 6* |
| | 1241170-1 | 1534072-1 | 9,604 | 1241170-1 | 1534072-1 |
| | 1241170-2 | 1534072-2 | 4,900 | 1394355-2 | 1534077-2 |
| | 1241170-3 | 1534072-3 | 3,136 | 1394355-3 | 1534077-3 |
| | 1-1241170-3 | 1-1534072-3 | 3,136 | 1-1394355-3 | 1-1534077-3 |
| | 1241170-4 | 1534072-4 | 2,352 | 1394355-4 | 1534077-4 |
| | 1-1241170-4 | 1-1534072-4 | 2,352 | 1-1394355-4 | 1-1534077-4 |
| | 1241170-5 | 1534072-5 | 1,960 | 1394355-5 | 1534077-5 |
| | 1-1241170-5 | 1-1534072-5 | 1,960 | 1-1394355-5 | 1-1534077-5 |

*)According to IEC 60695-2-1/1; GWT (Glow Wire Test) 750 °C without flame, see VDE M-Test Report.
The final keying version will be produced on the Application Tooling Equipment.

Indirect Mating Connector System (continued)

Technical Data

Wire Size Range:
0.35–1.0 mm²

**Current Carrying Capacity
(max.):**
10 A

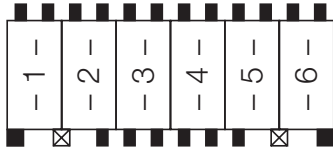
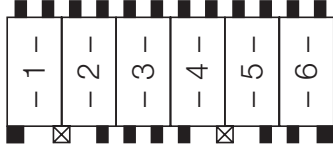
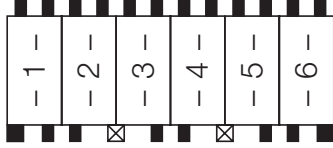
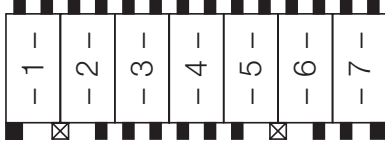
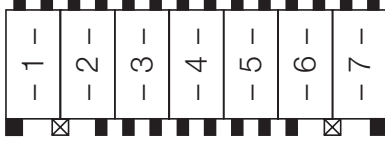
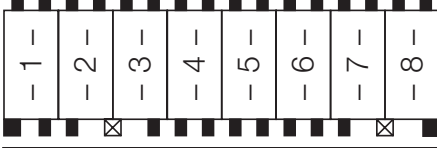
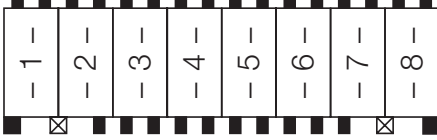
| RAST 5 Version | Part Numbers with Exterior Locking | | Package Quantity | Part Numbers with Interior Locking | |
|---|---------------------------------------|-------------|---------------------|---------------------------------------|-----------|
| | PA 6.6 | PA 6* | | PA 6.6 | PA 6* |
|  | 1241170-6 | 1534072-6 | 1,568 | - | - |
|  | 1-1241170-6 | 1-1534072-6 | 1,568 | - | - |
|  | 2-1241170-6 | 2-1534072-6 | 1,568 | - | - |
|  | 1241170-7 | 1534072-7 | 1,372 | - | - |
|  | 1-1241170-7 | 1-1534072-7 | 1,372 | 1394355-7 | 1534077-7 |
|  | 1241170-8 | 1534072-8 | 1,176 | - | - |
|  | 1-1241170-8 | 1-1534072-8 | 1,176 | - | - |

*)According to IEC 60695-2-1/1; GWT (Glow Wire Test) 750 °C without flame, see VDE M-Test Report.
The final keying version will be produced on the Application Tooling Equipment.

Indirect Mating Connector System (continued)

Technical Data

Wire Size Range:
1.0–1.5 mm²

Current Carrying Capacity (max.):
16 A

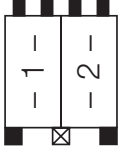
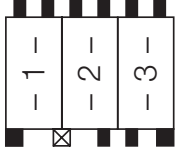
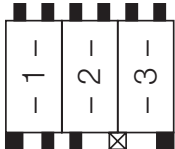
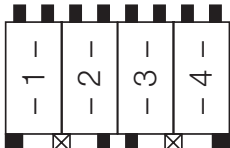
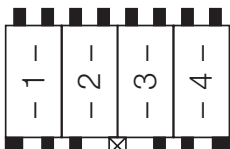
| RAST 5 Version | Part Numbers with Exterior Locking | | Package Quantity | Part Numbers with Interior Locking | |
|---|------------------------------------|-------------|------------------|------------------------------------|-------------|
| | PA 6.6 | PA 6 * | | PA 6.6 | PA 6 * |
|  | 1241171-1 | 1534073-1 | 9,604 | 1241171-1 | 1534073-1 |
|  | 1241171-2 | 1534073-2 | 4,900 | 1394556-2 | 1534078-2 |
|  | 1241171-3 | 1534073-3 | 3,136 | 1394556-3 | 1534078-3 |
|  | 1-1241171-3 | 1-1534073-3 | 3,136 | 1-1394556-3 | 1-1534078-3 |
|  | 1241171-4 | 1534073-4 | 2,352 | 1394556-4 | 1534078-4 |
|  | 1-1241171-4 | 1-1534073-4 | 2,352 | 1-1394556-4 | 1-1534078-4 |

*)According to IEC 60695-2-1/1; GWT (Glow Wire Test) 750 °C without flame, see VDE M-Test Report.
The final keying version will be produced on the Application Tooling Equipment.

2
RAST 5

PC Board Frame

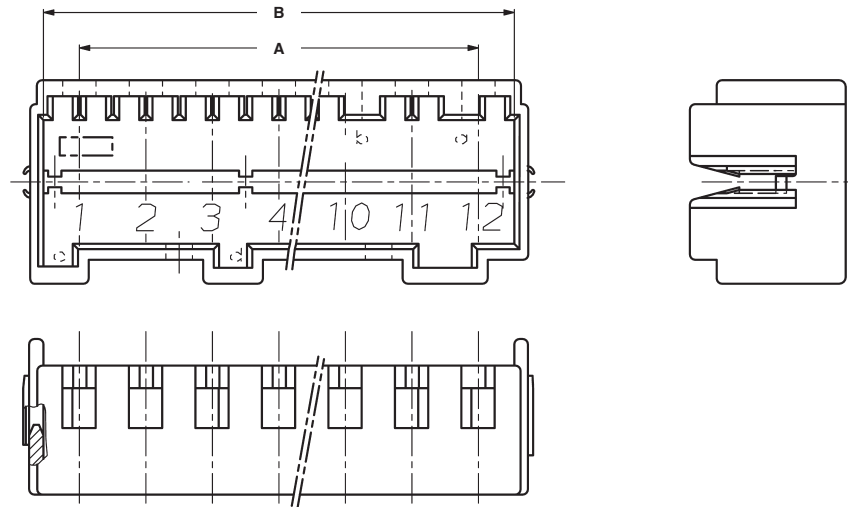
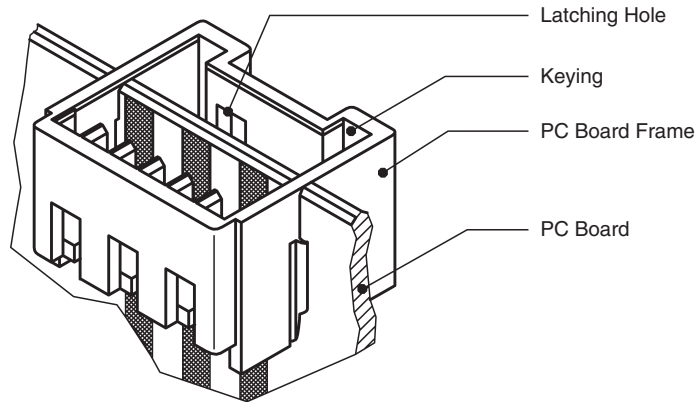

| No. of Positions | Dimensions (mm) | | Keying | Latching | Polarisation | Additional Board Lock | Part Number | Package Quantity |
|------------------|-----------------|------|----------------------------------|---------------------------------|--------------------------------|-----------------------|-------------------------------|------------------|
| | A | B | | | | | PC Board Frame, PA 6.6, Black | |
| 2 | 5 | 10.1 | 1c, 2d | 1/2 | — | — | 2-964577-2 | 2,200 |
| | | | 1c, 2d, 3c | 1/2, 3/4 | 2b | — | 1-964577-4 | |
| 4 | 15 | 20.1 | 1c, 3c, 4d | 1/2, 3/4 | 4b | — | 2-964577-4 | 1,700 |
| | | | 1c, 3c, 4d | 1/2, 3/4 | 1b, 4a | — | 3-964577-4 | |
| 5 | 20 | 25.1 | 3d | 1/2, 4/5 | — | — | 1-964577-5 | 1,500 |
| 6 | 25 | 30.1 | 4d | 1/2, 5/6 | 6b | — | 1-964577-6 | 1,500 |
| | | | 4d | 1/2, 5/6 | 1b, 6a | — | 2-964577-6 | |
| 7 | 30 | 35.1 | 2c, 3d, 7c | 2/3, 5/6 | 1b, 2b | 4/5 | 1-964577-7 | 1,200 |
| | | | 2c, 3d, 7c | 2/3, 5/6 | 2b, 7a | 4/5 | 2-964577-7 | |
| 8 | 35 | 40.1 | 2c, 3d, 7c | 2/3, 7/8 | 2a | 4/5 | 1-964577-8 | 1,000 |
| | | | 2c, 3d, 7c | 2/3, 7/8 | 2b, 4b | 4/5 | 2-964577-8 | |
| 12 | 55 | 60.1 | 1c, 2d, 3c, 4d, 5c, 8c, 10d, 12d | 1/2, 3/4, 5/6, 8/9, 9/10, 11/12 | 2b, 3a, 4a, 6a, 7a, 7b, 8a, 8b | 4/5, 8/9 | 1-964578-2 | 500 |

Preferred Parts are printed bold

Introduction

AMP MONO-SHAPE Connectors in In-Line Mating Technology

AMP MONO-SHAPE connectors represent a valid solution to the ever-increasing requirements for production and application flexibility. They are high productivity, great flexibility, quality, minimum applied cost.

AMP MONO-SHAPE product-line includes a full range of 5.0 mm pitch modular connectors contents with similar outer shape, several variation in the mating area such as PC Board and 6.3 x 0.8 mm tabs (RAST 5), plus a version for harness shunts.

AMP MONO-SHAPE connection system adopts the IDC termination technology, which improves application results and quality level.

The AMP MONO-SHAPE product range, combined with the performances and properties offered by the termination system, allow to manufacture extremely complicated harness structures while still maintaining high production levels.

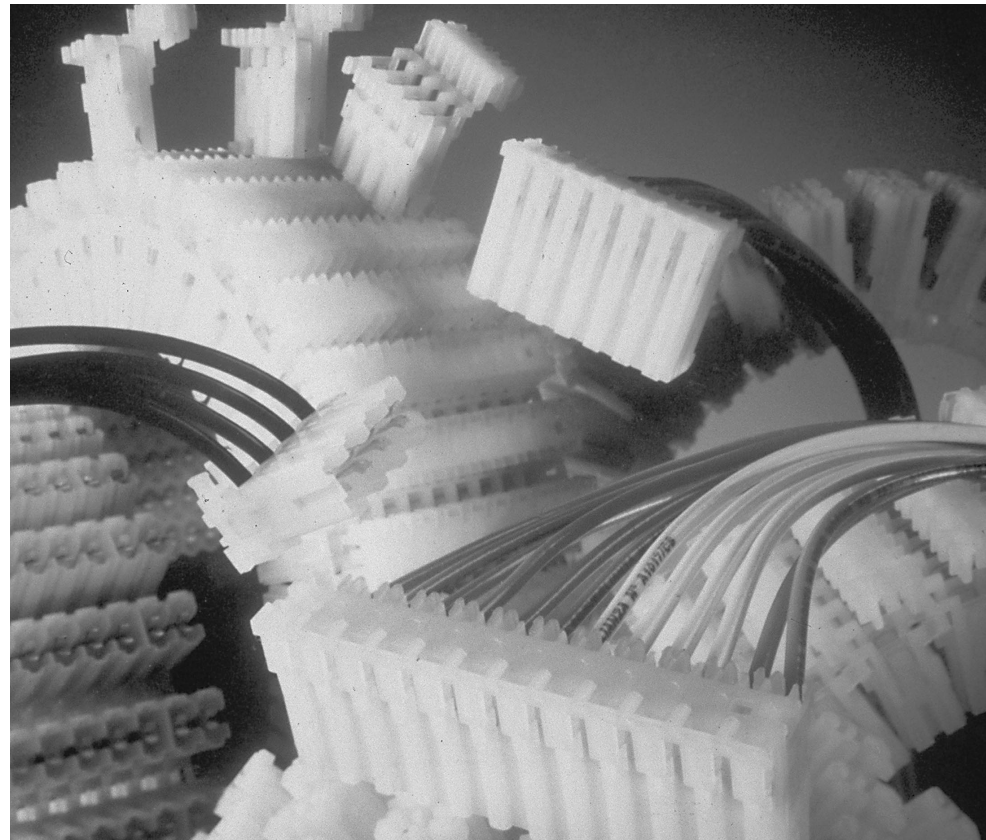

Technical Features

- IDC Connector system design to maximise the full integration with the application tooling assuring total flexibility in harness design.
- High current system, up to 16 Ampere, designed to satisfy several appliance requirements.
- ID Contact designed to accept standard discrete wires ranging from 0.5 up to 1.5 mm², according to the connector configuration.
- The connector incorporates modern in-line mating technology on a 5.0 mm centerline with no loss of spacing and a variety of keying possibilities.
- Wiring faults eliminated through high automation.
- Approvals:
VDE: 4751-1431-4024 / A 10A and
4751-1431-4024 / A 9E
UL E 28476 Vol. 9 Sec. 7;
97 ME 17936; AP-27HB

AMP MONO-SHAPE Connector Versions

Same Shape - Different Applications

With the same outside shape four connector versions are available, which are to handle with the same application tooling.

TAB Connectors

2–12 position 5.0 mm pitch connectors with insulation displacement contacts mateable with components according to RAST 5 and with tinned copper alloy tab 6.3 x 0.8 mm according to DIN 46244.

Wire Size Range:
0.5–1.5 mm²

Current Rating:
16 Ampere max. acc. to wire size

-For LIF version up to
10 Ampere max

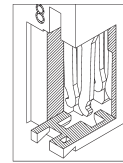
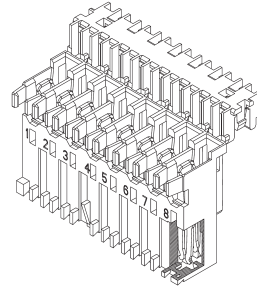

LIF version 2 point contact instead of 4 as per standard version

Single Way Connectors

Single Way connectors with insulation displacement contacts for use on tinned copper alloy tab 6.3 x 0.8 mm according to DIN 46244.

Wire Size Range:
0.5–1.5 mm²

Current Rating:
16 Ampere max. acc. to wire size

Supply Status:
In order to increase product-ivity these items are supplied in sticks.

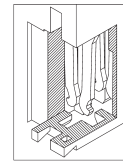
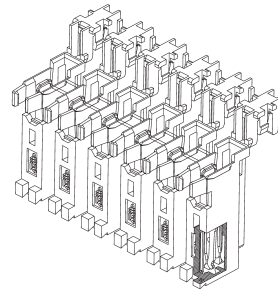

PCB Connectors

2–12 position 5.0 mm pitch connectors with insulation displacement contacts according to printed circuit boards with thickness 1.5±0.2 mm and 5.0 mm pitch.

Wire Size Range:
0.5–0.75 mm²

Current Rating:
6 Ampere max. acc. to wire size

PC Board:
Single or both sides printed 5 µm tin over 35 µm copper

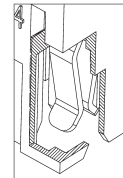
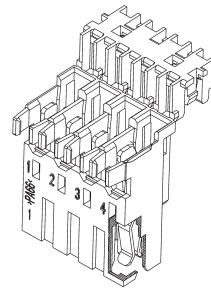

Satellite Connectors

3 position connectors, pitch 5.0 mm, with short circuited insulation displacement contacts for harness shunts.

Wire Size Range:
0.5–1.5 mm²

Current Rating:
16 Ampère max. acc. to wire size

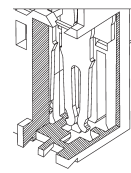
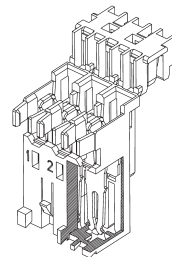

TAB Connector

AMP MONO-SHAPE TAB Connector

- 1 Cover closed after Wire Insertion. Wire Direction 90°. 180° when locked in Cover Recess
- 2 Cavity Numbers
- 3 Polarisation similar to the Keying (Located on the Back Side)
- 4 Keying
- 5 Interior Locking Latch
- 6 Colour Marking

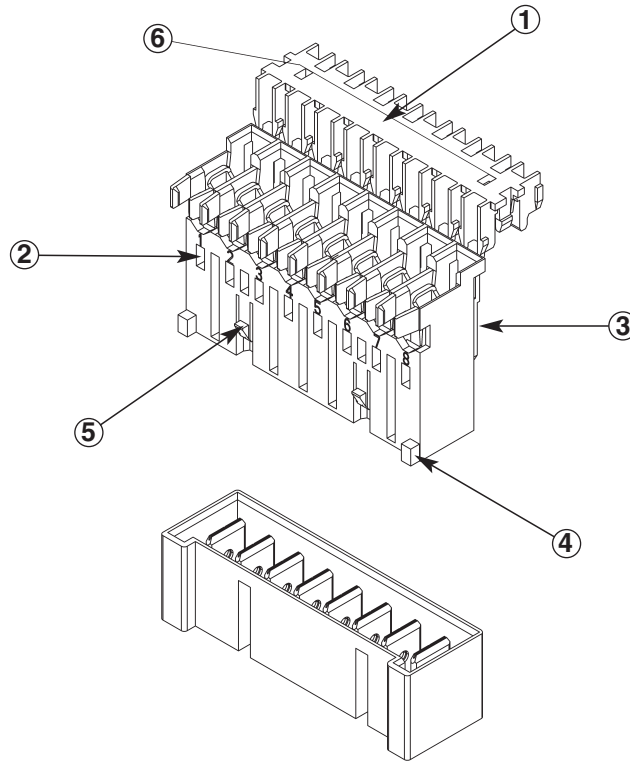

Technical Features

Centerline:
5.0 mm, according to RAST 5 specifications

Configurations:
2- to 12-positions

Housing Material:
Plastic PA 6.6

Housing Colour:
Natural colour for standard version
Grey colour for LIF version

Contact Material:
Copper alloy, post-tinned
2.0 µm min.

Polarisation, Keying, Locking Latches:
according to RAST 5 specifications
(see customer drawings)

Track Resistance:
as per IEC 112 (250 V)

Glow Wire Test:
as per IEC 695-2-1 (850 °C)
and 750°C no flame

Air and Creepage Distance:
according to EN 60998-1
(IEC 998-1) for 380 V, ≥4.0 mm

Voltage Resistance:
according to EN 60998-1
(IEC 998-1) 1750 V for 4 minutes

Insulation Resistance:
according to EN 60998-1
(IEC 998-1) >5 MΩ

Wire Size Range:
from 0.5 to 1.5 mm²

**Current Rating:
Standard Version**
16 A max. according to wire size
0.5 mm² ≤ 3 A, 0.75 mm² ≤ 6 A,
1.0 mm² ≤ 10 A, 1.5 mm² ≤ 16 A

LIF Version
10 A max. according to wire size
0.5 mm² ≤ 3 A, 0.75 mm² ≤ 6 A,
1.0 mm² ≤ 10 A, 1.5 mm² ≤ 10 A

Rated Voltage:
380 Volts max.

Wire Type:
H05V-K (70 °C max.)
or FR 3/2 (105 °C max.)
for 0.5–1.0 mm² wires with
copper or tinned stranded wires
H07V-K (70 °C max.)

or FR 3/2 (105 °C max.)
for wires from 1.5 mm² with
copper or tinned stranded wires
Insulation Type:
PVC suitable for temperatures
up to 70 °C / 105 °C

Insulation Diameter Range:
2.0–3.5 mm

Temperature Range:
–25 °C up to +105 °C

Wire Extraction Force/Way:
50 N min. on wire size 0.5 mm²

Application Specification:
114-20016

Product Specification:
Standard version: 108-20065
LIF version: 108-20215

Homologations:
acc.to VDE File No. 3905
(to 16 A) and UL File No.
E28476 (to 14 A)

Keying Plan

Keying Plan from Mating Direction,

- 1 Locking Latch
- 2 Slanted Keying Rib
- 3 Keying Rib
- 4 Polarisation Rib
- 5 Cavity Number

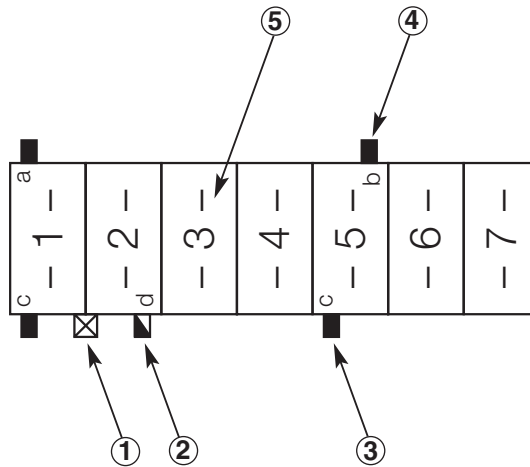

AMP MONO-SHAPE TAB Connector

2 Position RAST 5 Variations (Variable Keying)*

| Suitable for RAST 5 Version Colour Marking | RAST 5 Version | Part Numbers | | | Packaging Unit | | |
|---|----------------|---------------------------------|---------------------------------|------------------------|----------------|-------------|---------|
| | | On Tray | Loose Piece | On Reel | On Reel | Loose Piece | On Reel |
| 02-B 02-E 02-F Grey | | 1-282002-2 1-284338-2 | 2-282002-2 2-284338-2 | 3-282002-2 — | 6.500 | 3.500 | 28.500 |
| 02-C Black | | 1-282002-1 1-284338-1 | 2-282002-1 2-284338-1 | 2-282002-1 — | 6.500 | 3.500 | 28.500 |
| 02-L 02-P Red | | 1-282002-3 1-284338-3 | 2-282002-3 2-284338-3 | — 3-284338-3 | 6.500 | 3.500 | 28.500 |
| 02-A 02-O Blue | | 1-282002-4 1-284338-4 | 2-282002-4 — | — — | 6.500 | 3.500 | — |
| 02-Q Black | | 1-282002-5 | 2-282002-5 | — | 6.500 | 3.500 | — |
| — Black | | 1-282002-6 | 2-282002-6 | — | 6.500 | 3.500 | — |
| — — | | 1-282002-7 1-284338-7 | 2-282002-7 — | 3-282002-7 — | 6.500 | 3.500 | 28.500 |

* Final keying version is produced on the Application Tooling Machines.

Bold Part Numbers are LIF Version

AMP MONO-SHAPE TAB Connector

3 Position RAST 5 Variations (Variable Keying)*

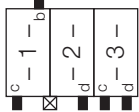
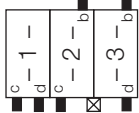
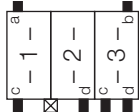
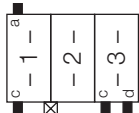
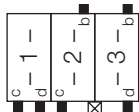
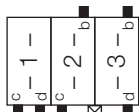
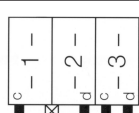
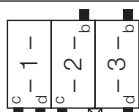
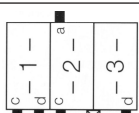
| Suitable for RAST 5 Version Colour Marking | RAST 5 Version | Part Numbers | | | Packaging Unit | | |
|---|---|---------------------------------|---------------------------------|-----------------|----------------|-------------|---------|
| | | On Tray | Loose Piece | On Reel | On Reel | Loose Piece | On Reel |
| 03-A 03-I Orange |  | 1-282003-1 1-284339-1 | 2-282003-1 2-284339-1 | 3-282003-1 — | 4.160 | 2.500 | 24.000 |
| 03-B 03-K Blue |  | 1-282003-2 1-284339-2 | 2-282003-2 2-284339-2 | 3-282003-2 — | 4.160 | 2.500 | 24.000 |
| 03-F Green |  | 1-282003-3 1-284339-3 | 2-282003-3 2-284339-3 | — — | 4.160 | 2.500 | — |
| 03-D — |  | 282233-2 | 282233-2 | — | 4.160 | 2.500 | — |
| 03-B 03-K Red |  | 1-282003-4 1-284339-4 | 2-282003-4 2-284339-4 | — — | 4.160 | 2.500 | — |
| 03-B 03-K Grey |  | 1-282003-5 1-284339-5 | 2-282003-5 2-284339-5 | — — | 4.160 | 2.500 | — |
| — Violet |  | 1-282003-6 | 2-282003-6 | — | 4.160 | 2.500 | — |
| 03-B Black |  | 1-282003-7 | — | — | 4.160 | — | — |
| — Black |  | 1-284396-1 | — | — | 4.160 | — | — |

* Final keying version is produced on the Application Tooling Machines.

Bold Part Numbers are LIF Version

AMP MONO-SHAPE TAB Connector

4 Position RAST 5 Variations (Variable Keying)*

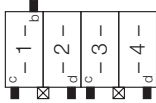
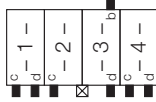
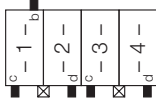
| Suitable for RAST 5 Version Colour Marking | RAST 5 Version | Part Numbers | | | Packaging Unit | | |
|---|---|--------------|-------------|------------|----------------|-------------|---------|
| | | On Tray | Loose Piece | On Reel | On Reel | Loose Piece | On Reel |
| 04-A Grey |  | 1-282004-1 | 2-282004-1 | 3-282004-1 | 2.120 | 2.000 | 18.750 |
| 04-D Black |  | 1-282004-2 | 2-282004-2 | 3-282004-2 | 2.120 | 2.000 | 18.750 |
| 04-A Red |  | 1-282004-3 | 2-282004-3 | — | 2.120 | 2.000 | — |

5 Position RAST 5 Variations (Variable Keying)*

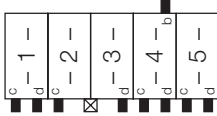
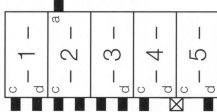
| Suitable for RAST 5 Version Colour Marking | RAST 5 Version | Part Numbers | | | Packaging Unit | | |
|---|---|--------------|-------------|---------|----------------|-------------|---------|
| | | On Tray | Loose Piece | On Reel | On Reel | Loose Piece | On Reel |
| Red |  | 1-282005-1 | 2-282005-1 | — | 2.600 | 1.500 | 18.750 |
| Red |  | 1-284545-1 | — | — | 2.600 | 1.500 | 18.750 |

* Final keying version is produced on the Application Tooling Machines.

AMP MONO-SHAPE TAB Connector

6 Position RAST 5 Variations (Variable Keying)*

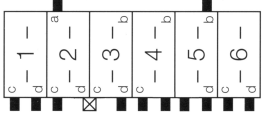
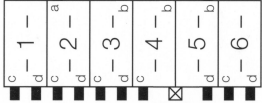
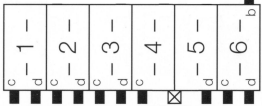
| Suitable for RAST 5 Version Colour Marking | RAST 5 Version | Part Numbers | | | Packaging Unit | | |
|---|---|--------------|-------------|------------|----------------|-------------|---------|
| | | On Tray | Loose Piece | On Reel | On Reel | Loose Piece | On Reel |
| Violet |  | 1-282006-1 | 2-282006-2 | 3-282006-2 | 2.080 | 1.200 | 13.500 |
| — |  | 1-282006-3 | 2-282006-3 | 3-282006-3 | 2.080 | 1.200 | 13.500 |
| Red |  | 1-284745-1 | — | — | 2.080 | — | — |

7 Position RAST 5 Variations (Variable Keying)*

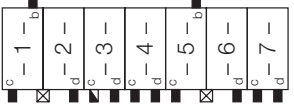
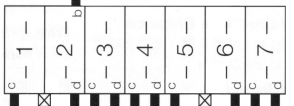
| Suitable for RAST 5 Version Colour Marking | RAST 5 Version | Part Numbers | | | Packaging Unit | | |
|---|---|--------------|-------------|---------|----------------|-------------|---------|
| | | On Tray | Loose Piece | On Reel | On Reel | Loose Piece | On Reel |
| — |  | 1-282007-1 | 2-282007-1 | — | 1.820 | 1.200 | — |
| Black |  | 1-284397-1 | — | — | 1.820 | 1.200 | — |

AMP MONO-SHAPE TAB Connector

8 Position RAST 5 Variations (Variable Keying)*

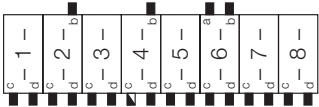
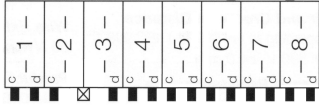
| Suitable for RAST 5 Version Colour Marking | RAST 5 Version | Part Numbers | | | Packaging Unit | | |
|---|---|-------------------|-------------------|---------|----------------|-------------|---------|
| | | On Tray | Loose Piece | On Reel | On Reel | Loose Piece | On Reel |
| — |  | 284085-1 | 2-284085-1 | — | 1.560 | 900 | — |
| | | 1-284685-1 | 2-284685-1 | — | | | |
| Violet |  | 284085-2 | 2-284085-2 | — | 1.560 | 900 | — |

* Final keying version is produced on the Application Tooling Machines.
Bold Part Numbers are LIF Version

10 Position RAST 5 Variations (Variable Keying)*

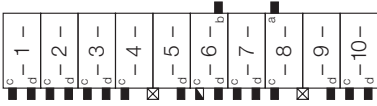
| Suitable for RAST 5 Version Colour Marking | RAST 5 Version | Part Numbers | | | Packaging Unit | | |
|--|---|-------------------|-------------------|---------|----------------|-------------|---------|
| | | On Tray | Loose Piece | On Reel | On Reel | Loose Piece | On Reel |
| — |  | 1-282010-1 | 2-282010-1 | — | 1.300 | 700 | — |
| | | 1-284686-1 | 2-284686-1 | — | | | |

* Final keying version is produced on the Application Tooling Machines.
Bold Part Numbers are LIF Version

AMP MONO-SHAPE Single Way Connector

Single Way Connector

- 1 All Single Way Connectors are supplied in "stick-form" by 6 single ways each. They will be cut from the Application Tooling Machines
- 2 Cover closed after Wire Insertion. Wire Direction 90°. 180° when locked in Cover Recess
- 3 Polarisation similar to the keying of the front side
- 4 Keying
- 5 Plastic Noses which Lock into the TAB Hole
- 6 Colour Marking

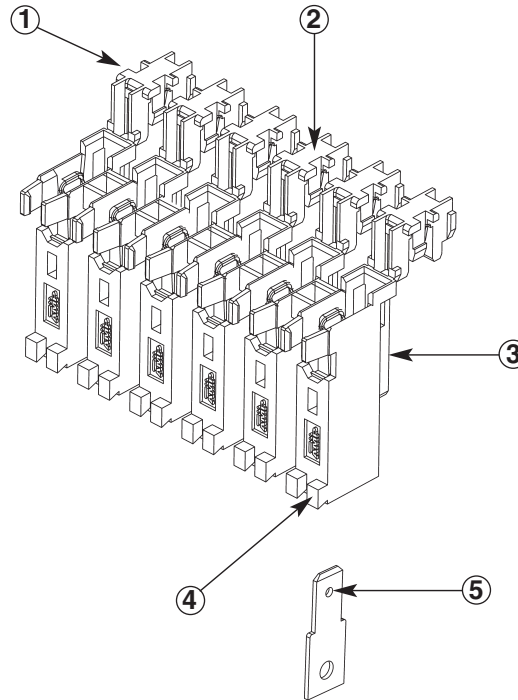

2
RAST 5

Technical Features

Centerline:
5.0 mm, according to RAST 5 specifications

Configurations:
1 position

Housing Material:
Plastic PA 6.6

Housing Colour:
Natural colour

Contact Material:
Copper alloy, post-tinned
2.0 µm min.

Polarisation, Keying, Locking Latches:
according to RAST 5 specifications
(see customer drawings)

Track Resistance:
as per IEC 112 (250 V)

Glow Wire Test:
as per IEC 695-2-1 (850 °C)
and 750°C no flame

Air and Creepage Distance:
according to EN 60998-1
(IEC 998-1) for 380 V, ≥4.0 mm

Voltage Resistance:
according to EN 60998-1
(IEC 998-1) 1750 V for 4 minutes

Insulation Resistance:
according to EN 60998-1
(IEC 998-1) >5 MΩ

Wire Size Range:
from 0.5 to 1.5 mm²

Current Rating:
16 A max. according to wire size
0.5 mm² ≤ 3 A, 0.75 mm² ≤ 6 A,
1.0 mm² ≤ 10 A, 1.5 mm² ≤ 16 A

Rated Voltage:
380 Volts max.

Wire Type:
H05V-K (70 °C max.)
or FR 3/2 (105 °C max.)
for 0.5–1.0 mm² wires with
copper or tinned stranded wires

H07V-K (70 °C max.)
or FR 3/2 (105 °C max.)
for wires from 1.5mm² with
copper or tinned stranded wires

Insulation Type:
PVC suitable for temperatures
up to 70 °C / 105 °C

Insulation Diameter Range:
2.0–3.5 mm

Temperature Range:
–25 °C up to +105 °C

Wire Extraction Force/Way:
50 N min. on wire size 0.5 mm²

Application Specification:
114-20017

Product Specification:
108-20066

Homologations:
acc.to VDE File No. 3905
(to 16 A) and UL File No.
E28476 (to 14 A)

Counter Part:
Tab 6.3 x 0.8 mm
as per DIN 46244 norms

Materials:
Copper alloy

Finishing:
Tinned (6.0 µm max.)

Keying Plan from Mating Direction

Keying Plan

- 1 Keying Rib
- 2 Polarisation Rib
- 3 Cavity Number

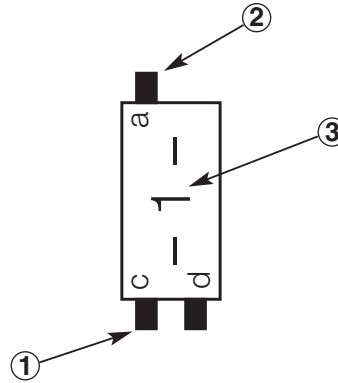

AMP MONO-SHAPE Single Way Connector

1 Position (Variable Keying)*

| Suitable for RAST 5 Version Colour Marking | RAST 5 Version | Part Numbers | | Packaging Unit | |
|---|----------------|--------------|------------|----------------|---------|
| | | On Tray | On Reel | On Tray | On Reel |
| — | | — | 1-282086-1 | 1.024 | 10.500 |
| Black | | — | 1-282086-2 | 1.024 | — |
| Orange | | — | 1-282086-3 | 1.024 | — |
| Green | | — | 1-282086-4 | 1.024 | — |
| Blue | | — | 1-282086-5 | 1.024 | — |
| Violet | | — | 1-282086-6 | 1.024 | — |

AMP MONO-SHAPE PCB (Printed Circuit Board) Connector

PCB Connector

- 1 Cover closed after Wire Insertion.
Wire Direction 90°. 180° when locked in Cover Recess
- 2 Cavity Numbers
- 3 Keying Slot in PC Board
- 4 Locking Hole in PC Board
- 5 Colour Marking

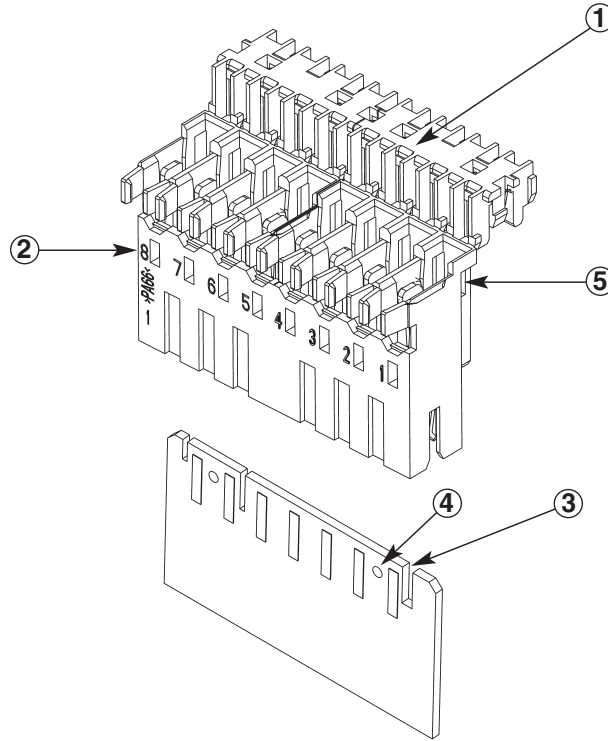

2
RAST 5

Technical Features

Centerline:
5.0 mm

Configurations:
2-12 positions

Housing Material:
Plastic PA 6.6

Housing Colour:
Natural colour

Contact Material:
Copper alloy, post-tinned
2.0 µm min.

Polarisation, Keying, Locking Latches:
according to RAST 5 specifications
(see customer drawings)

Track Resistance:
as per IEC 112 (250 V)

Glow Wire Test:
as per IEC 695-2-1 (850 °C)
and 750°C no flame

Air and Creepage Distance:
according to EN 60998-1
(IEC 998-1) for 240 V, ≥3.0 mm

Voltage Resistance:
according to EN 60998-1
(IEC 998-1) 1750 V for 4 minutes

Insulation Resistance:
according to EN 60998-1
(IEC 998-1) >5 MΩ

Wire Size Range:
from 0.5 to 0.75 mm²

Current Rating:
6 A max. according to wire size
0.5 mm² ≤3 A, 0.75 mm² ≤6 A

Rated Voltage:
220 Volts max.

Wire Type:
H05V-K (70 °C max.)
or FR 3/2 (105 °C max.)
for 0.5–1.0 mm² wires with
copper or tinned stranded wires
H07V-K (70 °C max.)
or FR 3/2 (105 °C max.)
for wires from 1.5mm² with
copper or tinned stranded wires

Insulation Type:
PVC suitable for temperatures
up to 70 °C / 105 °C

Insulation Diameter Range:
2.0–2.8 mm

Temperature Range:
–25 °C up to +105 °C

Wire Extraction Force/Way:
50 N min. on wire size 0.5 mm²

Application Specification:
114-20025

Product Specification:
108-20067

Homologations:
acc.to VDE File No. 3905
(to 6 A) and UL File No. E28476
(to 6 A)

Printed Circuit Board:
Thickness 1.5±0.2mm

Tinned Circuit Paths:
5.0mm pitch and width of
1.8mm

AMP MONO-SHAPE PCB (Printed Circuit Board) Connector

PCB Connector

- 1 PC Board
- 2 First Circuit Path
- 3 MONO-SHAPE Connector
- 4 Wire

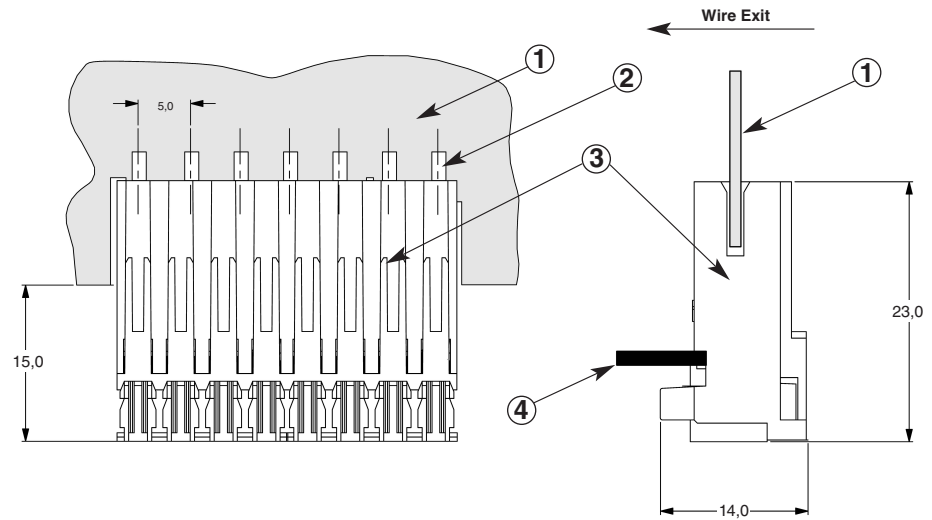

Notes Concerning the PC Board Layout

- 1 First circuit path
- 2 Slot for keying rib in front of first cavity (according to the connector 4.0 mm or 7.4 mm)
- 3 Bore hole for locking clip symmetric between two cavities (diameter 2.5 mm)
- 4 Slot for keying rib symmetric between two cavities

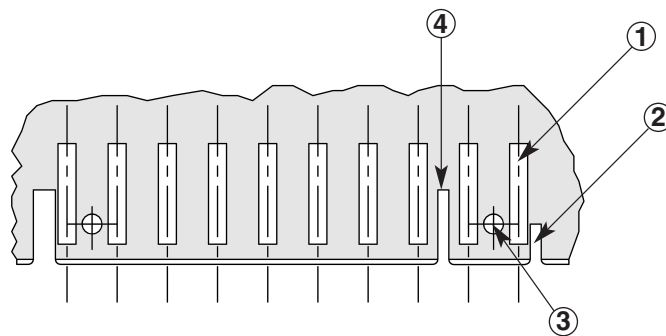

PC Board Layout Dimensions on request.

See Customer Drawing 282042

AMP MONO-SHAPE PCB (Printed Circuit Board) Connector

Centerline 5.0 mm

| No. of Positions Colour Marking | PC Board Cut-Out | Part Numbers | | | Packaging Unit | | |
|------------------------------------|---|--------------|-------------|------------|----------------|-------------|---------|
| | | On Tray | Loose Piece | On Reel | On Reel | Loose Piece | On Reel |
| 2 Brown |  | 1-282042-1 | 2-282042-1 | — | 5.980 | 3.500 | — |
| 2 Green |  | 1-282042-2 | 2-282042-2 | 3-282042-2 | 5.980 | 3.500 | 28.500 |
| 2 Blue |  | 1-282042-3 | 2-282042-3 | 3-282042-3 | 5.980 | 3.500 | 28.500 |
| 2 Red |  | 1-282042-4 | 2-282042-4 | — | 5.980 | 3.500 | — |
| 2 Black |  | 1-282042-5 | 2-282042-5 | 3-282042-5 | 5.980 | 3.500 | 28.500 |
| 3 — |  | 1-282043-2 | 2-282043-2 | 3-282043-2 | 4.160 | 2.500 | 24.000 |
| 3 Black |  | 1-282043-3 | 2-282043-3 | — | 4.160 | 2.500 | — |
| 3 — |  | 282235-2 | 2-282235-2 | — | 4.160 | 2.500 | — |
| 3 Black |  | 282235-3 | 2-282235-3 | — | 4.160 | 2.500 | — |
| 3 Blue |  | 1-1284546-1 | — | — | 4.160 | — | — |
| 4 — |  | 1-282044-1 | 2-282044-1 | 3-282044-1 | 3.120 | 2.000 | 18.750 |

2
Part 5



AMP MONO-SHAPE PCB (Printed Circuit Board) Connector

Centerline 5.0 mm (continued)

| No. of Positions Colour Marking | PC Board Cut-Out | Part Numbers | | | Packaging Unit | | |
|------------------------------------|------------------|--------------|-------------|------------|----------------|-------------|---------|
| | | On Tray | Loose Piece | On Reel | On Reel | Loose Piece | On Reel |
| 5 — | | 1-282045-1 | 2-282045-1 | 3-282045-1 | 2.600 | 1.500 | 18.750 |
| 5 Green | | 1-282045-2 | 2-282045-2 | 3-282045-2 | 2.600 | 1.500 | 18.750 |
| 5 — | | 1-282045-3 | 2-282045-3 | 3-282045-3 | 2.600 | 1.500 | 18.750 |
| 5 — | | 1-284733-1 | 2-284733-1 | 3-284733-1 | 2.600 | 1.500 | 18.750 |
| 6 — | | 1-282046-1 | 2-282046-1 | 3-282046-1 | 2.080 | 1.200 | 13.500 |
| 6 — | | 1-284734-1 | 2-284734-1 | 3-284734-1 | 2.080 | 1.200 | 13.500 |
| 7 — | | 1-282047-1 | 2-282047-1 | 3-282047-1 | 1.820 | 1.200 | 13.500 |
| 8 — | | 284208-1 | 2-284208-1 | — | 1.560 | 900 | — |
| 8 — | | 284574-1 | — | — | 1.560 | — | — |
| 9 — | | 1-282049-1 | 2-282049-1 | 3-282049-1 | 1.300 | 700 | 10.500 |
| 10 — | | 1-282050-1 | 2-282050-1 | 3-282050-1 | 1.300 | 700 | 10.500 |

AMP MONO-SHAPE PCB (Printed Circuit Board) Connector

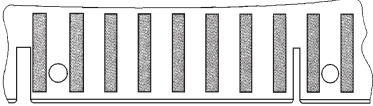
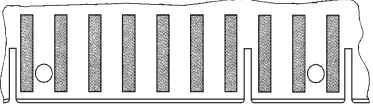
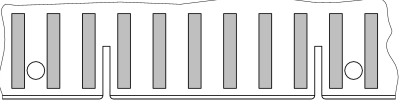
Centerline 5.0 mm (continued)

| No. of Positions Colour Marking | PC Board Cut-Out | Part Numbers | | | Packaging Unit | | |
|------------------------------------|---|--------------|-------------|------------|----------------|-------------|---------|
| | | On Tray | Loose Piece | On Reel | On Reel | Loose Piece | On Reel |
| 10 Black |  | 1-284401-1 | — | — | 1.300 | — | — |
| 10 — |  | 284575-1 | — | — | 1.300 | — | — |
| 11 — |  | 1-282051-1 | 2-282051-1 | 3-282051-1 | 1.040 | 700 | 10.500 |
| 12 — |  | 1-282052-1 | 2-282052-1 | 3-282052-1 | 1.040 | 700 | 10.500 |



Rast 5

AMP MONO-SHAPE Satellite Connector

Satellite Connector

- 1 Cover closed after Wire Insertion. Wire Direction 90°. 180° when locked in Cover Recess
- 2 Bridge between Contacts to have Short Circuit
- 3 Cavity Numbers
- 4 For Satellite version, the cavity 1 only accept TAB contact, other cavities are clogged

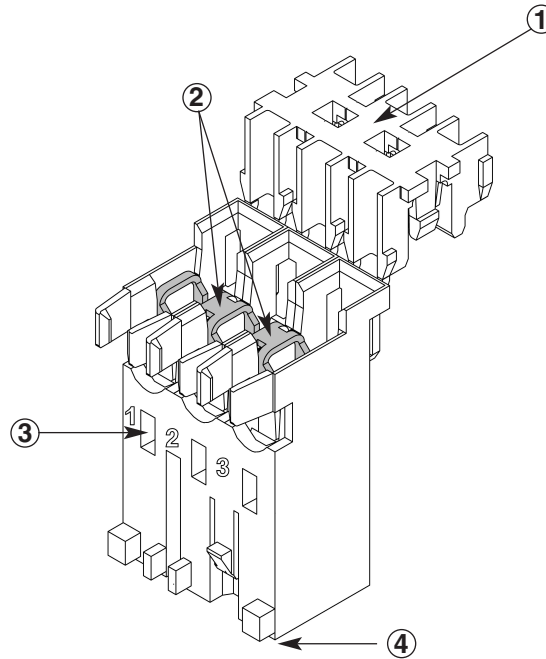

Technical Features

Centerline:

5.0 mm, according to RAST 5 specifications

Configurations:

3 positions only (for special version please contact Tyco Electronics)

Housing Material:

Plastic PA 6.6

Housing Colour:

Natural colour

Contact Material:

Copper alloy, post-tinned
2.0 µm min.

Polarisation, Keying,

Locking Latches:
according to RAST 5 specifications (see customer drawings)

Track Resistance:

as per IEC 112 (250 V)

Glow Wire Test:

as per IEC 695-2-1 (850 °C) and 750°C no flame

Air and Creepage Distance:

according to EN 60998-1 (IEC 998-1) for 380 V, ≥4.0 mm

Voltage Resistance:

according to EN 60998-1 (IEC 998-1) 1750 V for 4 minutes

Insulation Resistance:

according to EN 60998-1 (IEC 998-1) >5 MΩ

Wire Size Range:

from 0.5 to 1.5 mm²

Current Rating:

16 A max. according to wire size
0.5 mm² ≤ 3 A, 0.75 mm² ≤ 6 A,
1.0 mm² ≤ 10 A, 1.5 mm² ≤ 16 A

Rated Voltage:

380 Volts max.

Wire Type:

H07V-K (70 °C max.)
or FR 3/2 (105 °C max.)
for 0.5–1.0 mm² wires with copper or tinned stranded wires

H07V-K (70 °C max.)

or FR 3/2 (105 °C max.)

for wires from 1.5mm² with copper or tinned stranded wires

Insulation Type:

PVC suitable for temperatures up to 70 °C / 105 °C

Insulation Diameter Range:

2.0–3.5 mm

Temperature Range:

–25 °C up to +105 °C

Wire Extraction Force/Way:

50 N min. on wire size 0.5 mm²

Application Specification:

114-20026

Product Specification:

108-20070

Homologations:

acc.to VDE File No. 3905 (to 16 A) and UL File No. E28476 (to 14 A)

Keying Plan from Mating Direction

Keying Plan

- 1 Locking Latch
- 2 Keying Rib
- 3 Polarisation Rib
- 4 Cavity Number

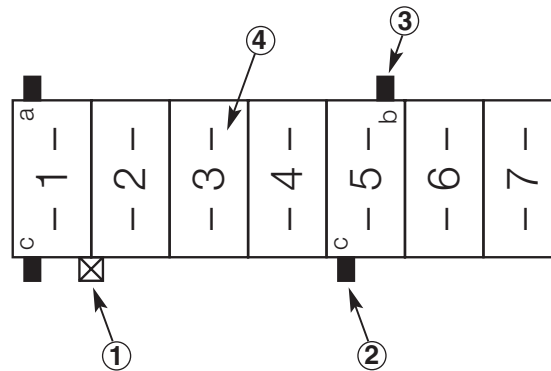

AMP MONO-SHAPE - 3 Position Satellite Connector (Variable Keying)*

| Suitable for RAST 5 Version Colour Marking | RAST 5 Version | Part Numbers | | | Packaging Unit | | |
|---|----------------|--------------|-------------|---------|----------------|-------------|---------|
| | | On Tray | Loose Piece | On Reel | On Reel | Loose Piece | On Reel |
| 03-A 03-I Black | | 1-282099-1 | — | — | 4.160 | — | — |

AMP MONO-SHAPE - 2 Position Satellite Connector

(Variable Keying)* Bridge between Contacts. Cavity Numbers 1-2 to have Short Circuit

| | | | | | | | |
|------------------------|--|------------|----------|---|-------|-------|---|
| 02-L 02-P — | | 1-284288-1 | 284288-1 | — | 6.500 | — | — |
| 02-L 02-P Orange | | — | 284288-2 | — | — | 3.000 | — |
| 02-L 02-P Blue | | 1-284288-3 | 284288-3 | — | 6.500 | 3.000 | — |
| 02-L 02-P Green | | — | 284288-4 | — | — | 3.000 | — |
| 02-L 02-P Violet | | — | 284288-5 | — | — | 3.000 | — |
| 02-L 02-P Black | | 1-284288-6 | 284288-6 | — | 6.500 | 3.000 | — |
| 02-C — | | — | 284288-7 | — | — | 3.000 | — |

* Final keying version is produced on the Application Tooling Machines.

Keying Plan from Mating Direction

AMP MONO-SHAPE Bridge Connector - 3 Position RAST 5 Variation (Variable Keying)* Bridge between Contacts. Cavity Numbers 1-2-3 to have Short Circuit

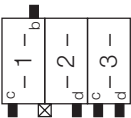
| Suitable for RAST 5 Version Colour Marking | RAST 5 Version | Part Numbers | | | Packaging Unit | | |
|---|---|--------------|-------------|---------|----------------|-------------|---------|
| | | On Tray | Loose Piece | On Reel | On Reel | Loose Piece | On Reel |
| 03-A 03-I Green |  | — | 284289-1 | — | — | 2.500 | — |

AMP MONO-SHAPE Bridge Connector - 6 Position RAST 5 Variation (Variable Keying)* Bridge between Contacts. Cavity Numbers 1-2-3 to have Short Circuit

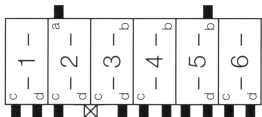
| Suitable for RAST 5 Version Colour Marking | RAST 5 Version | Part Numbers | | | Packaging Unit | | |
|---|---|--------------|-------------|---------|----------------|-------------|---------|
| | | On Tray | Loose Piece | On Reel | On Reel | Loose Piece | On Reel |
| — Green |  | — | 284290-1 | — | — | 1.200 | — |

AMP MONO-SHAPE Bridge Connector - 6 Position RAST 5 Variation (Variable Keying)* Bridge between Contacts. Cavity Numbers 1-2 and 3-4 to have Short Circuit

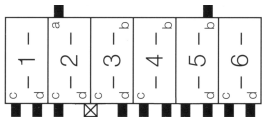
| Suitable for RAST 5 Version Colour Marking | RAST 5 Version | Part Numbers | | | Packaging Unit | | |
|---|---|--------------|-------------|---------|----------------|-------------|---------|
| | | On Tray | Loose Piece | On Reel | On Reel | Loose Piece | On Reel |
| — Black |  | — | 284290-2 | — | — | 1.200 | — |

AMP MONO-SHAPE Bridge Connector - 6 Position RAST 5 Variation (Variable Keying)* Bridge between Contacts. Cavity Numbers 1-2-3-4-5-6 to have Short Circuit

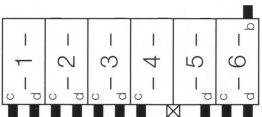
| Suitable for RAST 5 Version Colour Marking | RAST 5 Version | Part Numbers | | | Packaging Unit | | |
|---|---|--------------|-------------|---------|----------------|-------------|---------|
| | | On Tray | Loose Piece | On Reel | On Reel | Loose Piece | On Reel |
| — — |  | 1-284744-1 | — | — | 2.080 | — | — |

* Final keying version is produced on the Application Tooling Machines.

Introduction**AMP MONO-SHAPE MARK II Connectors in In-Line Mating Technology**

MONO-SHAPE Mark II Connector System was developed according to the newest level of knowledge and standard.

The requirements of advanced In-Line mating technology for the component and contact of printed circuit board (PCB) is granted by the two versions TAB and PCB connector systems.

System is designed to maximise the full integration with the application tooling, assuring the flexibility in the harness design.

This system is suitable for a wide wire size range of conductor and current carrying capacity up to 16 A.

Double termination is possible with 0.5 and 0.5mm² or 0.5 and 0.75mm² conductors. (See application spec. 114-20104 for details)

The connectors are available in 1 to 10 positions (TAB Version) with interior locking device and 2 to 12 positions (PCB Version)

Connectors are supplied in chain and provided with all keying and polarisation ribs the connectors can be handled automatically with a modern Application Tooling Equipment.

Wiring faults checked and eliminated through high automation.

Application Machines shall provide to print a colour code mark on the connectors cover after wire termination, feasible on all connectors configuration, for connector identification on harnesses.

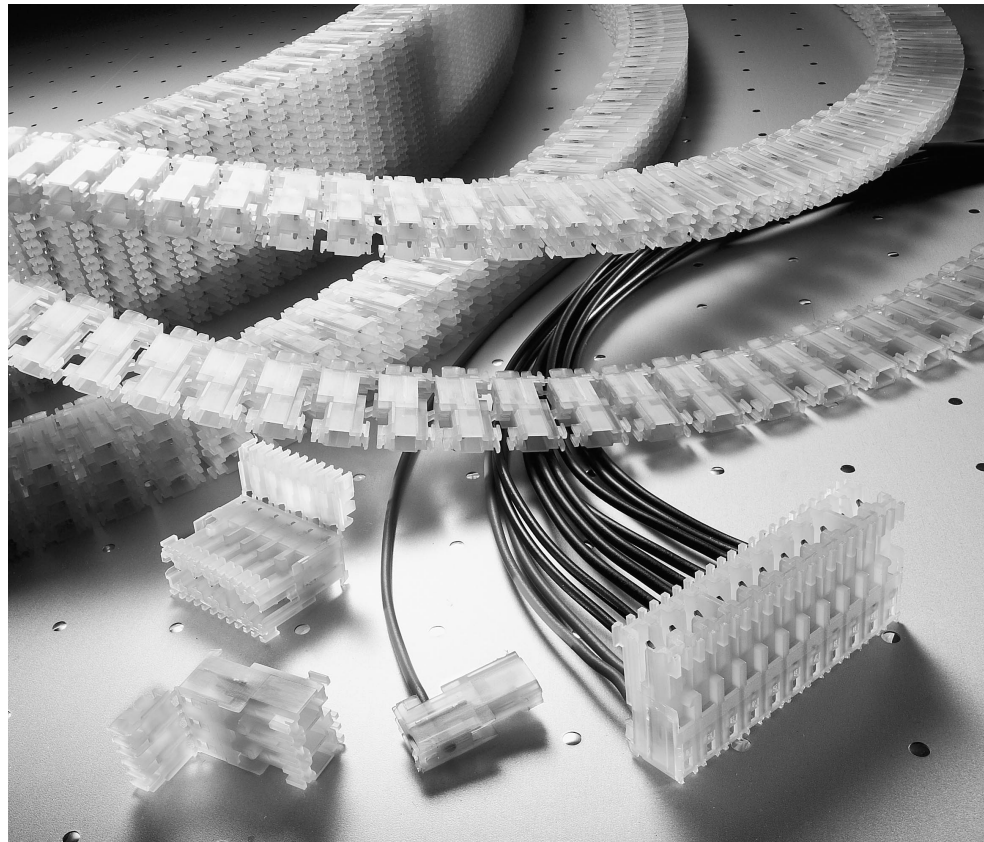
**Technical Features**

- Housing moulded in different materials for different applications
- Standard, Part Numbers with pre-dash 0 (as 0-284471-1) Housing in unfilled PA 6/6, UL 94V-2
- For UL94V0, Part Numbers with pre-dash 1 (as 1-284471-1) Housing in unfilled PA 6/6, UL 94V-0
- High Operating Temperature (up to 130°), Part Numbers with pre-dash 2 (as 2-284471-1) Unfilled PA 4/6, UL 94V-2 (available for TAB Version only)
- Glow Wire 750° no flame, Part Numbers with pre-dash 3 (as 3-284471-1) Housing in unfilled PA 6, UL 94V-2

Technical Data

Centerline:
5.0mm

Housing Material:
Polyamide, PA 6.6 and PA 6

Approvals:
VDE, UL CSA applied

Standard Colour:
Natural

Current Voltage:
250 V_~

Air and Creepage Distance:
>3.2mm

Flammability Rating:
According UL 94 V-2

TAB Connectors

1-10 position 5.0 pitch connectors with insulation displacement contacts mateable with components according to rast 5 and with tinned copper alloy tab contacts 6.3 x 0.8mm according to DIN 46244 and DIN 17670 Part 1.

TAB-BRIDGE Connectors

Same design as TAB Connectors but with a bridge between two adjacent contacts to have a Short Circuit between them.

Wire Size Range:
0.35–1.5 mm²

Current Rating:
16 Ampere max. acc. to
wire size used

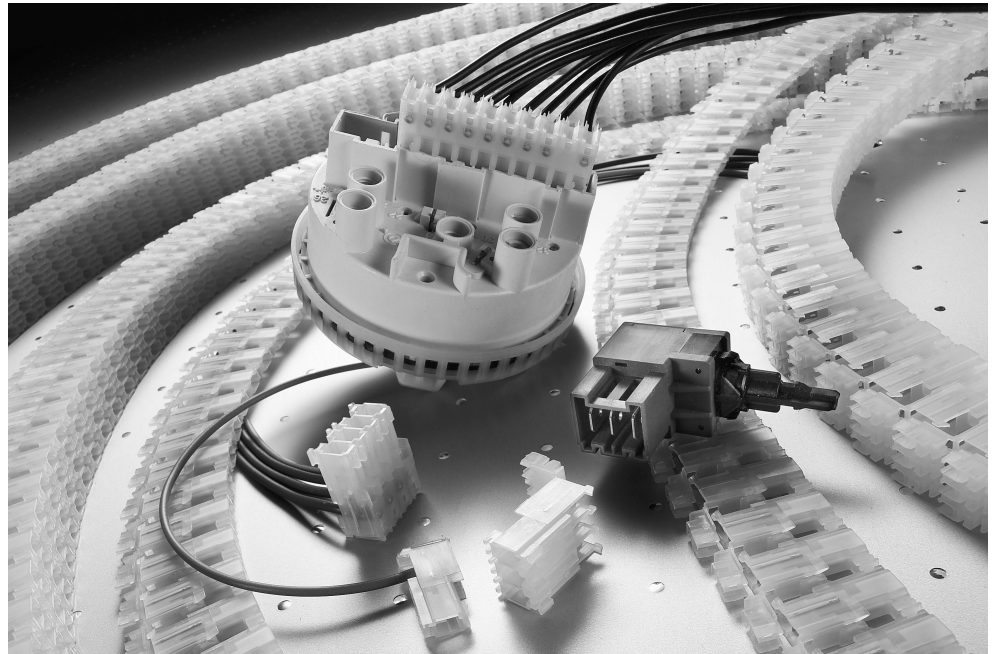

PCB Connectors

2–12 position 5.0 mm pitch connectors with insulation displacement contacts mateable with printed circuit boards (PCB)

Wire Size Range:
0.35–0.75 mm²

Current Rating:
6 Ampere max. acc. to
wire size used

PC Board:
Single or double side, with
thickness 1.6±0.2mm, FR4, 2 x
0.35 µm Copper 5µm tinned
tracks, 5.0mm pitch

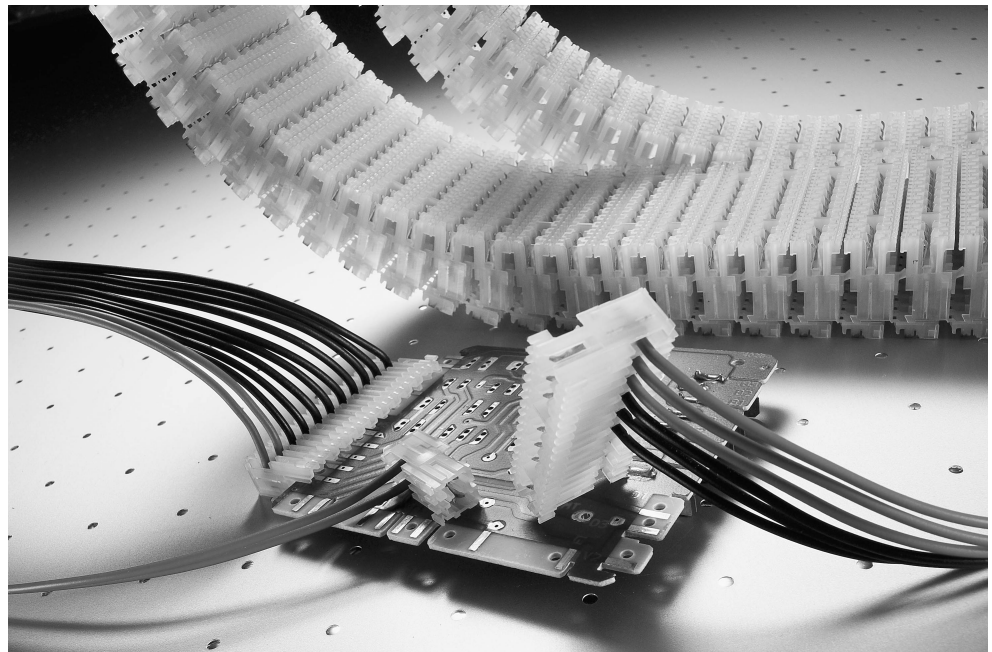

Keying Plan and Cable Exit

Keying Plan from Mating Direction, Fully Keyed Version

- 1 Locking Latch
- 2 Keying Rib
- 3 Polarisisation Rib
- 4 Cavity Number
- 5 Motor Mount Special Keying

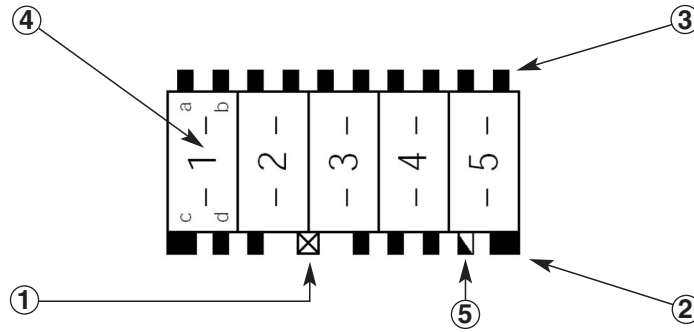

Example of Keyed Version: 05-C

This final keying version
will be produced on the
Application Tooling
Equipment

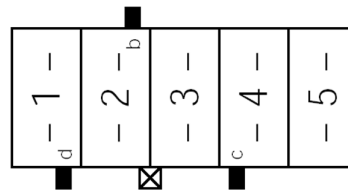

Cable Exit

- 1 Double Wire Exit
- 2 Wire Exit 90°
- 3 Wire Exit 180°
- 4 Cover
- 5 Interior Locking Latch
(for TAB Version only)
- 6 Keying
- 7 Polarisisation
- 8 Motor Mount
Special Keying
- 9 Colour Marking Area to
identify connectors after
harnesses are built up

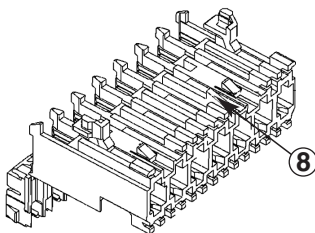
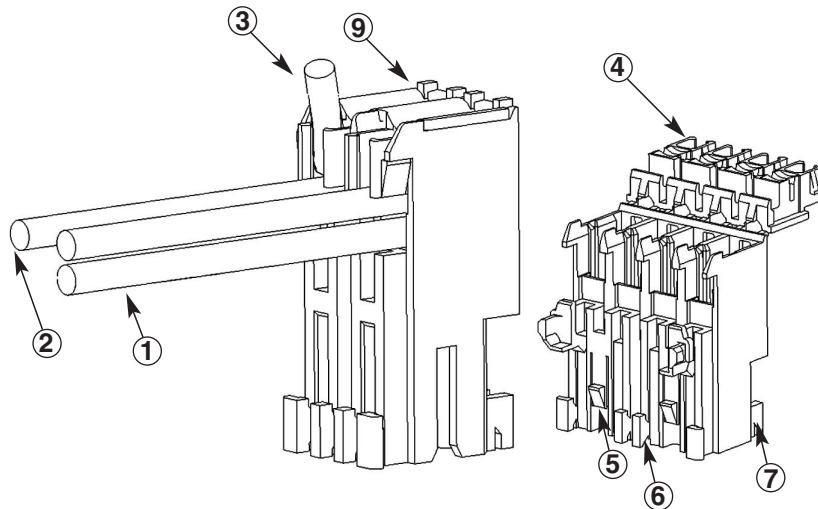

TAB Connector System

AMP MONO-SHAPE MARK II TAB Connector System

No. of Positions:
1 to 10 positions

Contact Material:
CuNi2Si

Contact Finish:
Tin Plated

Current Rating:
16 A, up to 4 contacts 16 A

Insulation Diameter:
3.0mm max.

Insulation Resistance:
>10 MΩ

Wire Size Range:
0.35-1.5mm²

Temperature Range:
-40°C up to +130°C

Product Specification:
108-20213

Application Specification:
114-20104

| No. of Positions | Colour Marking as Shipped | RAST 5 Version | Part Numbers | | | | Packaging Unit |
|------------------|---------------------------|----------------|--------------|------------|------------------|-------------------------|----------------|
| | | | Standard | UL94V0 | High Temperature | Glow Wire 750° no flame | |
| 1 | — | | 0-284471-1 | 1-284471-1 | 2-284471-1 | 3-284471-1 | 11000 |
| 2 | — | | 0-284472-1 | 1-284472-1 | 2-284472-1 | 3-284472-1 | 5500 |
| 3 | — | | 0-284473-1 | 1-284473-1 | 2-284473-1 | 3-284473-1 | 3520 |
| 3 | Blue | | 0-284473-2 | 1-284473-2 | 2-284473-2 | 3-284473-2 | 3520 |
| 4 | — | | 0-284474-1 | 1-284474-1 | 2-284474-1 | 3-284474-1 | 2640 |
| 4 | Blue | | 0-284474-2 | 1-28444-2 | 2-284474-2 | 3-284474-2 | 2640 |
| 5 | — | | 0-284475-1 | 1-284475-1 | 2-284475-1 | 3-284475-1 | 2200 |
| 6 | — | | 0-284476-1 | 1-284476-1 | 2-284476-1 | 3-284476-1 | 1760 |
| 6 | Violet | | 0-284476-4 | 1-284476-4 | 2-284476-4 | 3-284476-4 | 1760 |
| 7 | — | | 0-284477-1 | 1-284477-1 | 2-284477-1 | 3-284477-1 | 1540 |

TAB Connector System (continued)

AMP MONO-SHAPE MARK II TAB Connector System



RAST 5

| No. of Positions | Colour Marking as Shipped | RAST 5 Version | Part Numbers | | | | Packaging Unit |
|------------------|---------------------------|----------------|--------------|------------|------------------|-------------------------|----------------|
| | | | Standard | UL94V0 | High Temperature | Glow Wire 750° no flame | |
| 7 | Blue | | 0-284477-2 | 1-284477-2 | 2-284477-2 | 3-284477-2 | 1540 |
| 7 | Red | | 0-284477-3 | 1-284477-3 | 2-284477-3 | 3-284477-3 | 1540 |
| 8 | — | | 0-284478-1 | 1-284478-1 | 2-284478-1 | 3-284478-1 | 1320 |
| 8 | Blue | | 0-284478-2 | 1-284478-2 | 2-284478-2 | 3-284478-2 | 1320 |
| 10 | — | | 0-284480-1 | 1-284480-1 | 2-284480-1 | 3-284480-1 | 1100 |

TAB-BRIDGE Connector System - Short Circuit

AMP MONO-SHAPE MARK II TAB-BRIDGE Connector System - Short Circuit

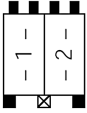
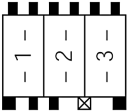
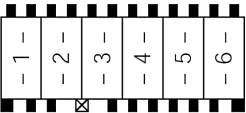
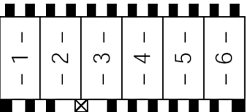
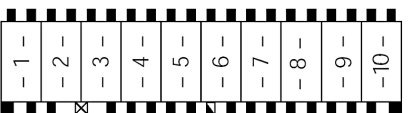
| No. of Positions | Colour Marking as Shipped | RAST 5 Version | Bridge Between Cavity Numbers | Part Numbers | | | Packaging Unit | |
|------------------|---------------------------|---|-------------------------------|--------------|------------|------------------|----------------|-------------------------|
| | | | | Standard | UL94V0 | High Temperature | | Glow Wire 750° no flame |
| 2 | Blue |  | 1-2 | 0-284472-2 | 1-284472-2 | 2-284472-2 | 3-284472-2 | 5500 |
| 3 | Red |  | 1-2 | 0-284473-3 | 1-284473-3 | 2-284473-3 | 3-284473-3 | 3520 |
| 6 | Blue |  | 1-2-3 | 0-284476-2 | 1-284476-2 | 2-284476-2 | 3-284476-2 | 1760 |
| 6 | Red |  | 1-2 | 0-284476-3 | 1-284476-3 | 2-284476-3 | 3-284476-3 | 1760 |
| 10 | Blue |  | 7-8 | 0-284480-2 | 1-284480-2 | 2-284480-2 | 3-284480-2 | 1100 |

PCB Connector System

No. of Positions:
2 to 12 positions

Contact Material:
Brass

Contact Finish:
Tin Plated

Current Rating:
6 A max.

Insulation Diameter:
2.8mm max.

Insulation Resistance:
>10 MΩ

Wire Size Range:
0.35-0.75mm²

Temperature Range:
-40°C up to +105°C

Product Specification:
108-20214

Application Specification:
114-20104

AMP MONO-SHAPE MARK II PCB Connector System

- 1 PC Board
- 2 First Circuit Path
- 3 MONO-SHAPE Connector
- 4 Wire

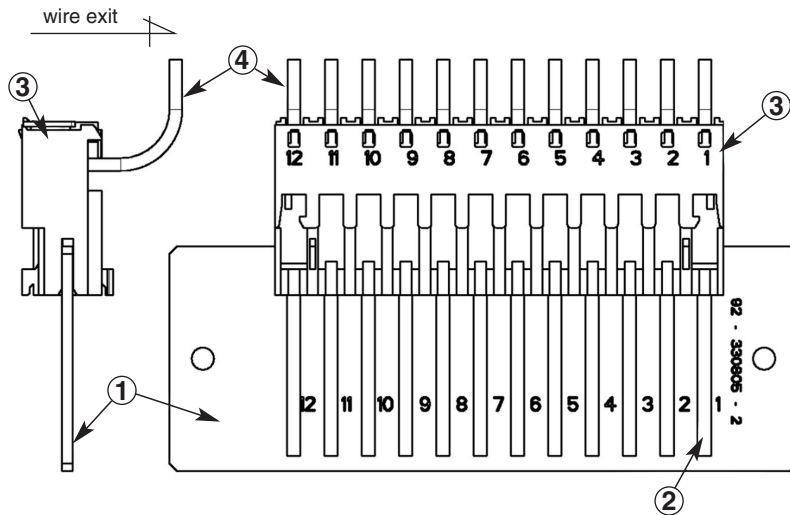

Notes Concerning the PC Board Layout

See also Customer Drawing
284482 and Drawing
93-330805-2 for Test PCB
Layout

- 1 First circuit path, mate with
Connector way No. 1
- 2 Slot for connector keying rib
Adjacent to first and/or last
way
Based on connector design,
for 3.5mm or 7.5mm length
- 3 Hole for locking clip,
symmetric
Between two ways
(diameter 2.5)
- 4 Slot for connector keying rib
symmetric between two
ways. Position based on
connector design, for
7.5mm length

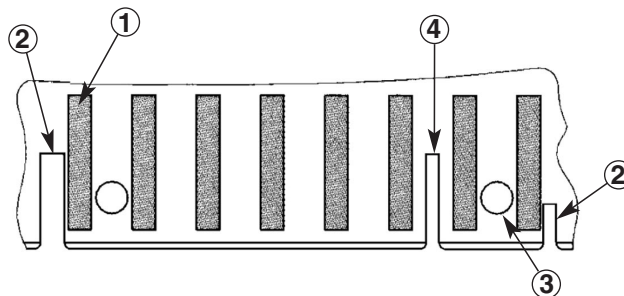

PCB Connector System (continued)

AMP MONO-SHAPE MARK II PCB Connector System

| No. of Positions | Colour Marking as Shipped | RAST 5 Version | Part Numbers | | | Packaging Unit |
|------------------|------------------------------|---|--------------|------------|----------------------------|-------------------|
| | | | Standard | UL94V0 | Glow Wire 750° no flame | |
| 2 | Green |  | 0-284482-1 | 1-284482-1 | 3-284482-1 | 5500 |
| 2 | Black |  | 0-284482-2 | 1-284482-2 | 3-284482-2 | 5500 |
| 2 | Violet |  | 0-284482-3 | 1-284482-3 | 3-284482-3 | 5500 |
| 2 | Orange |  | 0-284482-4 | 1-284482-4 | 3-284482-4 | 5500 |
| 2 | Grey |  | 0-284482-5 | 1-284482-5 | 3-284482-5 | 5500 |
| 2 | Red |  | 0-284482-6 | 1-284482-6 | 3-284482-6 | 5500 |
| 3 | Green |  | 0-284483-1 | 1-284483-1 | 3-284483-1 | 3520 |
| 3 | Black |  | 0-284483-2 | 1-284483-2 | 3-284483-2 | 3520 |
| 3 | Violet |  | 0-284483-3 | 1-284483-3 | 3-284483-3 | 3520 |
| 3 | Orange |  | 0-284483-4 | 1-284483-4 | 3-284483-4 | 3520 |
| 4 | Green |  | 0-284484-1 | 1-284484-1 | 3-284484-1 | 2640 |

PCB Connector System (continued)

AMP MONO-SHAPE MARK II PCB Connector System

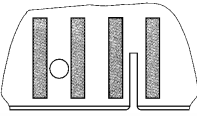
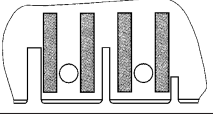
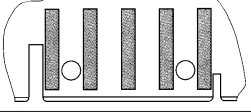
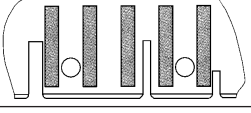
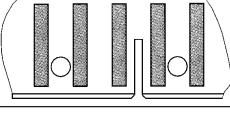
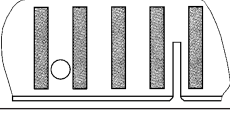
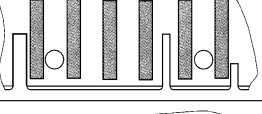
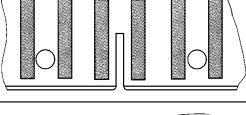
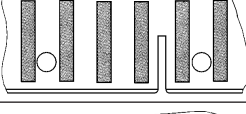
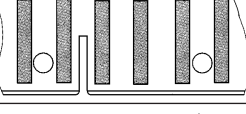
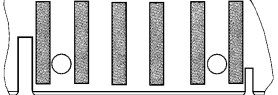
| No. of Positions | Colour Marking as Shipped | RAST 5 Version | Part Numbers | | | Packaging Unit |
|------------------|---------------------------|---|--------------|------------|-------------------------|----------------|
| | | | Standard | UL94V0 | Glow Wire 750° no flame | |
| 4 | Black |  | 0-284484-2 | 1-284484-2 | 3-284484-2 | 2640 |
| 4 | Violet |  | 0-284484-3 | 1-284484-3 | 3-284484-3 | 2640 |
| 5 | Green |  | 0-284485-1 | 1-284485-1 | 3-284485-1 | 2200 |
| 5 | Black |  | 0-284485-2 | 1-284485-2 | 3-284485-2 | 2200 |
| 5 | Violet |  | 0-284485-3 | 1-284485-3 | 3-284485-3 | 2200 |
| 5 | Orange |  | 0-28485-4 | 1-284485-4 | 3-284485-4 | 2200 |
| 6 | Green |  | 0-284486-1 | 1-284486-1 | 3-284486-1 | 1760 |
| 6 | Black |  | 0-284486-2 | 1-284486-2 | 3-284486-2 | 1760 |
| 6 | Violet |  | 0-284486-3 | 1-284486-3 | 3-284486-3 | 1760 |
| 6 | Orange |  | 0-284486-4 | 1-284486-4 | 3-284486-4 | 1760 |
| 6 | Grey |  | 0-284486-5 | 1-284486-5 | 3-284486-5 | 1760 |

2
RAST 5

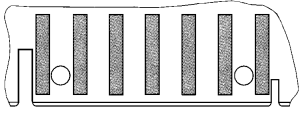
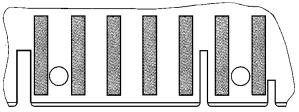
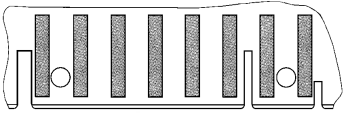

PCB Connector System (continued)

AMP MONO-SHAPE MARK II PCB Connector System

| No. of Positions | Colour Marking as Shipped | RAST 5 Version | Part Numbers | | | Packaging Unit |
|------------------|------------------------------|---|--------------|------------|----------------------------|-------------------|
| | | | Standard | UL94V0 | Glow Wire 750° no flame | |
| 7 | Green |  | 0-284487-1 | 1-284487-1 | 3-284487-1 | 1540 |
| 7 | Black |  | 0-284487-2 | 1-284487-2 | 3-284487-2 | 1540 |
| 7 | Violet |  | 0-284487-3 | 1-284487-3 | 3-284487-3 | 1540 |
| 8 | Green |  | 0-284488-1 | 1-284488-1 | 3-284488-1 | 1320 |
| 8 | Black |  | 0-284488-2 | 1-284488-2 | 3-284488-2 | 1320 |
| 8 | Violet |  | 0-284488-3 | 1-284488-3 | 3-284488-3 | 1320 |
| 8 | Orange |  | 0-284488-4 | 1-284488-4 | 3-284488-4 | 1320 |
| 9 | Green |  | 0-284489-1 | 1-284489-1 | 3-284489-1 | 1100 |
| 9 | Black |  | 0-284489-2 | 1-284489-2 | 3-284489-2 | 1100 |
| 9 | Violet |  | 0-284489-3 | 1-284489-3 | 3-284489-3 | 1100 |
| 9 | Orange |  | 0-284489-4 | 1-284489-4 | 3-284489-4 | 1100 |

PCB Connector System (continued)

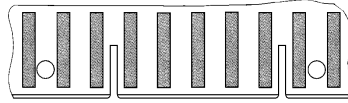
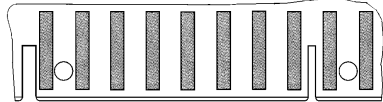
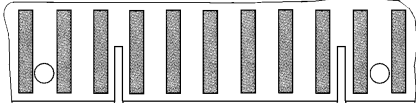
AMP MONO-SHAPE MARK II PCB Connector System

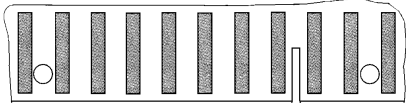
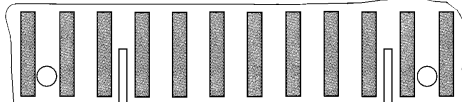
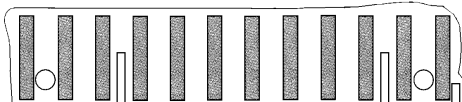
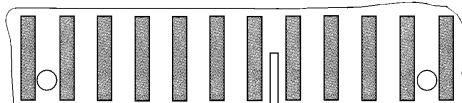
| No. of Positions | Colour Marking as Shipped | RAST 5 Version | Part Numbers | | | Packaging Unit |
|------------------|------------------------------|---|--------------|------------|----------------------------|-------------------|
| | | | Standard | UL94V0 | Glow Wire 750° no flame | |
| 10 | Green |  | 0-284490-1 | 1-284490-1 | 3-284490-1 | 1100 |
| 10 | Black |  | 0-284490-2 | 1-284490-2 | 3-284490-2 | 1100 |
| 11 | Green |  | 0-284491-1 | 1-284491-1 | 3-284491-1 | 880 |
| 11 | Black |  | 0-284491-2 | 1-284491-2 | 3-284491-2 | 880 |
| 11 | Violet |  | 0-284491-3 | 1-284491-3 | 3-284491-3 | 880 |
| 12 | Green |  | 0-284492-1 | 1-284492-1 | 3-284492-1 | 880 |
| 12 | Black |  | 0-284492-2 | 1-284492-2 | 3-284492-2 | 880 |
| 12 | Violet |  | 0-284492-3 | 1-284492-3 | 3-284492-3 | 880 |

2
RAST 5

Application Tooling

Entry Level Semi-Automatic IDC Bench Machines

SIM 500P

Part No. 528376-2

SIM 500T

Part No. 528377-2

In the Entry Level concept, the application process is shared by two different semi-automatic machines.

The SIM 500P prepares the AMP multifitting Mark II banded IDC connectors. The machine removes the connector from the chain and cuts the keying ribs.

Next, the prepared IDC connectors are applied by the SIM 500T.

To facilitate this, the individual IDC connectors are loaded into a nest and moved automatically into the termination station.

The manually inserted wires are, according to a program,

terminated into the appropriate insulation displacement slots. The cover is then separated from the housing, turned and pushed into final position.

The nest, including the finished harness module, is removed from the easily accessed track.



SIM 500P

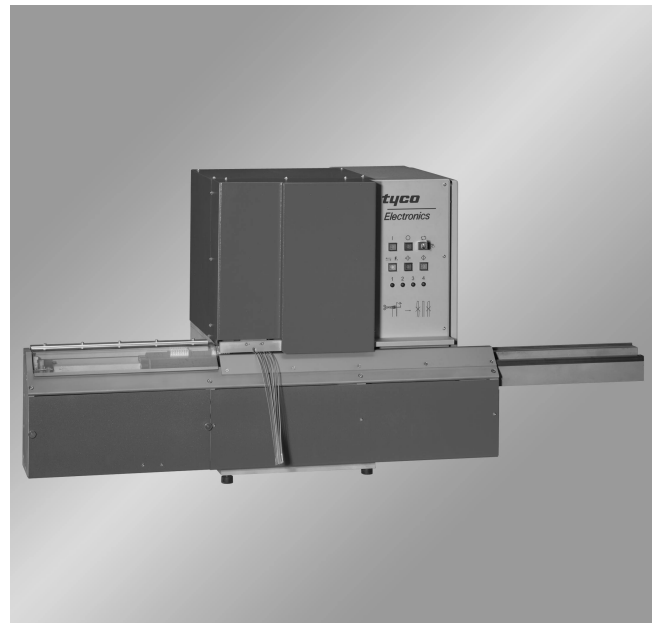

SIM 500T

Technical Features

- Processing of all versions of the AMP multifitting Mark II connector system with only minor set up changes.
- Cutting and reliable removal of the reel clips.
- Cutting and reliable removal of the coding and polarisation ribs by means of a preset cutting block.
- Nest capacity per machine cycle
 - one connector 4- to 8-pos.
 - two connectors 2- and 3-pos.
 - four connectors 1-position
- Integrated monitoring of the connector supply.
- Simple operator interface.

Technical Data

Power Supply:
230 V AC, 50 Hz

Air Pressure:
6 bar

Cycle Time:
approx. 4 s / connector package (without handling time)

Technical Features

- Application of all versions of the AMP multifitting Mark II connector, with only minor set up changes.
- Termination of the wire with active support of the IDC contact.
- Termination of two wires (double wire termination) programmable.
- Connector fixture, incorporating three nests for max. 12 positions each.
- Accessible and easily interchangeable mechanical program rail.
- By utilising several connector fixtures and program rails, output and set up times can be optimised.
- Simple operator interface.

Technical Data

Power Supply:
230 V AC, 50 Hz

Air Pressure:
6 bar

Cycle Time:
approx. 1.2 s / line (without handling time)

Application Tooling (continued)

IDC Workstation – SIM 50

This semi-automatic machine was designed for the sequential processing of AMP multifitting Mark II IDC connector system and its variations such as direct and indirect mating connector with interior or exterior locking.

A processing sequence can consist of one or more IDC connectors of the same or different numbers of positions, but a maximum total of 12 positions.

The specific key coding of the connectors is performed during the termination process by an integrated cutting device.

The wires are manually fed into the machine and then automatically terminated.

Integrated control tests ensure a high quality product.

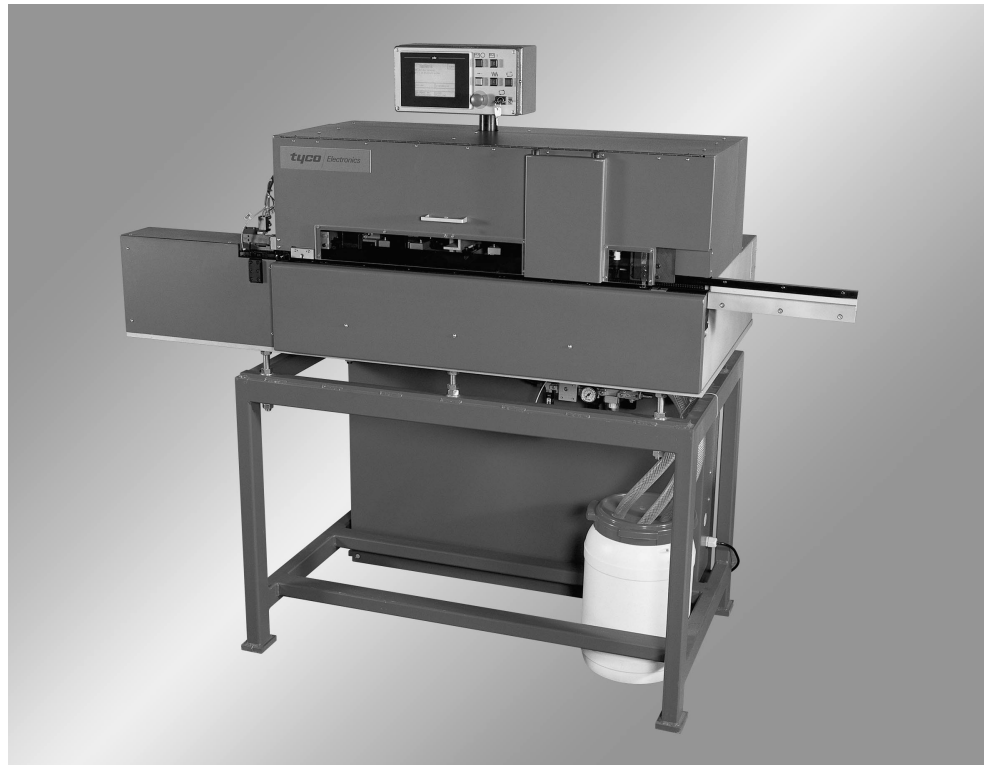

Technical Features

- Processing of all versions of the AMP multifitting Mark II connector system without additional set up time.
- Termination of the wire with active support of the IDC contact.
- Termination of two wires in the same slot is programmable.
- Colour coding on the connector cover possible.
- Wire exit angle can be bent 180°.
- Short set up and change-over times.
- High output.
- Correct wire insertion length and key codings are continually checked.
- Good / bad sorter; faulty connections will be destroyed.
- 50 different production programs can be stored.
- Operator PC interface displaying machine status and production data; different languages available.
- Low maintenance costs and the capability of off-site troubleshooting via modem.
- Ergonomic and easy to operate through a Touch Screen Display.

Technical Data

- Power Supply:**
230 V AC, 50 Hz
- Air Pressure:**
6 bar
- Wire Size Range:**
0.35 mm² up to 1.5 mm²
- Insulation Diameter Range:**
1.2 mm up to 3.0 mm
- Wire Type:**
Stranded conductors

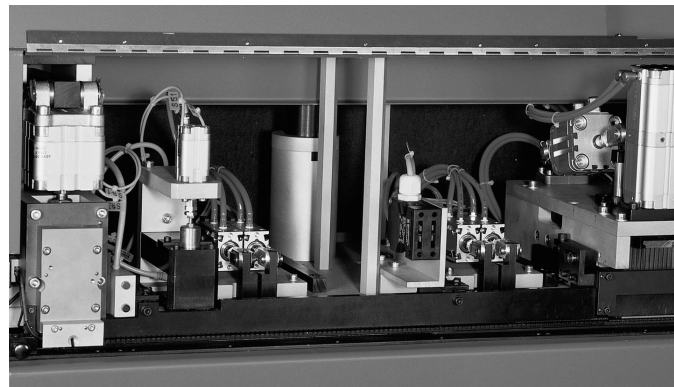

Processing Modules of the SIM 50

Application Tooling (continued)

Flexible Harness Maker – FHM

The FHM is a fully-automatic machine featuring modular set up. It is built to manufacture harnesses by processing both IDC connectors and crimp terminals.

The basic machine includes a 12 wire selector, a station that cuts the wires to length, a stripping station, a double-crimp unit, two crimping presses and wire end ejector for doubling and daisy chains.

A gripper unit takes the wire from the base machine and transfers it to the attached IDC station. Sequential processing allows the manufacturing of cross-overs and bridges as well as double-crimps, depending on the type of IDC connector used.

The IDC workstations are easily reconfigured for processing our different IDC connector systems. They include all the necessary processing operations for IDC termination with minimum change-over and set up times.

Quality checks integrated in the manufacturing process ensure the highest quality harness for every production run.



Technical Features

- Manufacturing of harnesses with 2.5 mm pitch IDC connectors and/or 5.0 mm pitch IDC connectors and/or with crimp terminals.
- IDC Workstations are available for the following connector systems:
 - AMP DUOPLUG 2.5
 - AMP DUOPLUG 2.5 Mark II
 - AMP DUOPLUG Power
 - AMP multifitting Mark II
 - AMP MONO-SHAPE Mark II
- The IDC Workstations can also be used as separate semi-automatic machines with manual wire transfer.
- The specific key coding of the IDC connector is done on the IDC Workstation.
- Integrated test equipment checks the coding and the insertion depth of the wire, and performs a continuity test. A spark testing unit is also available as an option.
- Wire printing and single housing insertion possible.
- Operator PC interface displays machine status and production data; different languages available.
- Low maintenance costs and the capability of off-site troubleshooting via modem.
- Ergonomic and easy to operate through a Touch Screen Display.

Technical Data

- Power Supply:**
400 V AC, 50 Hz
- Air Pressure:**
6 bar
- Wire Size Range:**
0.22 mm² up to 1.5 mm²
- Wire Length:**
220 mm up to 2,500 mm
- Insulation Diameter Range:**
1.2 mm up to 3.0 mm
- Wire Type:**
Stranded conductors

Application Tooling (continued)

IDC Harness Maker – IHM Mark III

The new IHM Mark III is a very high performance, fully-automatic machine designed to manufacture parallel jumper harnesses using IDC technology.

The simultaneous feeding of up to 21 wires guarantees high productivity and flexibility and a choice of 2.5 mm or 5.0 mm pitch IDC systems.

The gripper unit on the left side of the machine is able to spread the wires in both directions to enable the production of harnesses using both 2.5 mm and 5.0 mm pitch connectors at the same time.

Available options are a stripper crimper unit with an integrated crimp force analyser and a good/bad sorting unit.

The IDC workstations are easily reconfigured for processing our different IDC connector systems. They include all the necessary processing operations for IDC termination with minimum change-over and set up times.

Quality checks integrated in the manufacturing process ensure the highest quality harness for every production run.

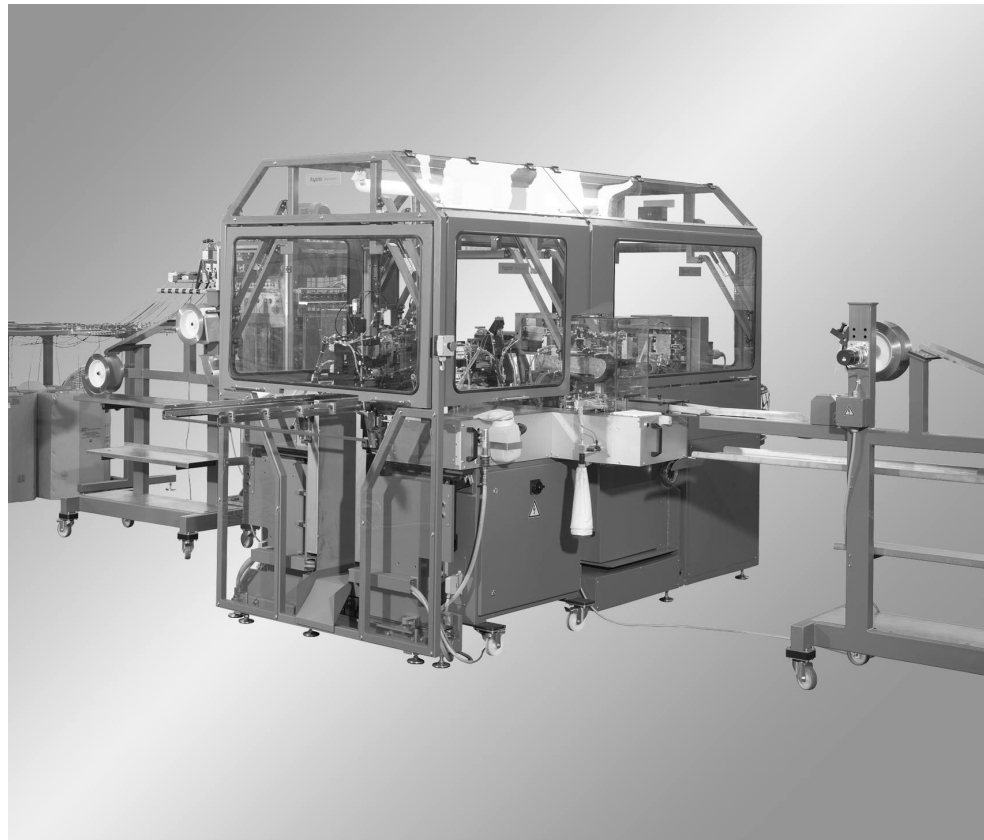

Technical Features

- Manufacturing of harnesses using 2.5 mm and/or 5.0 mm pitch IDC systems.
- Very short wire length is possible.
- Option available to produce harnesses with crimp terminals on one side.
- IDC Workstations are available for the following connector systems:
 - AMP DUOPLUG 2.5
 - AMP DUOPLUG 2.5 Mark II
 - AMP DUOPLUG Power
 - AMP multifitting Mark II
 - AMP MONO-SHAPE Mark II
 - AMP MT Edge
- The specific key coding of the IDC connector is done on the IDC Workstation.
- Integrated test equipment checks the coding and the insertion depth of the wire, and performs a continuity test. A spark testing unit is also available as an option.
- Operator PC interface displays machine status and production data; different languages available.
- Low maintenance costs and the capability of off-site troubleshooting via modem.
- Ergonomic and easy to operate through a Touch Screen Display.

Technical Data

- Power Supply:**
400 V AC, 50 Hz
- Air Pressure:**
6 bar
- Wire Size Range:**
0.22 mm² up to 1.5 mm²
- Wire Length:**
125 mm up to 2,200 mm
- Insulation Diameter Range:**
1.2 mm up to 3.0 mm
- Wire Type:**
Stranded conductors

Introduction

AMP Standard Timer Connectors in In-Line Mating Technology

AMP Standard Timer connectors according to RAST 5.0 mm standard have been developed to connect RAST 5 components (like motors, leach pumps, water level regulators, relays and push-button switches) in the Household Appliances Industry.

They meet industry requirements, for example multiple position connectors, secure connection even at inclining mating as well as a sturdy contact design.

AMP Standard Power Timer contacts, for use with Standard Timer housings, are suitable for high density and high current capacity up to 16 A.

Housing is designed for end-to-end stacking without contact loss. They are available in different keying and locking versions from 2- positions to 12-positions.

Standard Timer contacts can be used with stranded wires from 0.5 mm² to 2.5 mm² and can be double terminated. Of course, the corresponding tooling is available, too.

AMP Standard Timer connectors are tested by VDE and fulfil all requirements acc. to VDE 0700 (air gap, creepage distance, glow wire test, ball pressure test, creepage current strength).

UL recognised component.

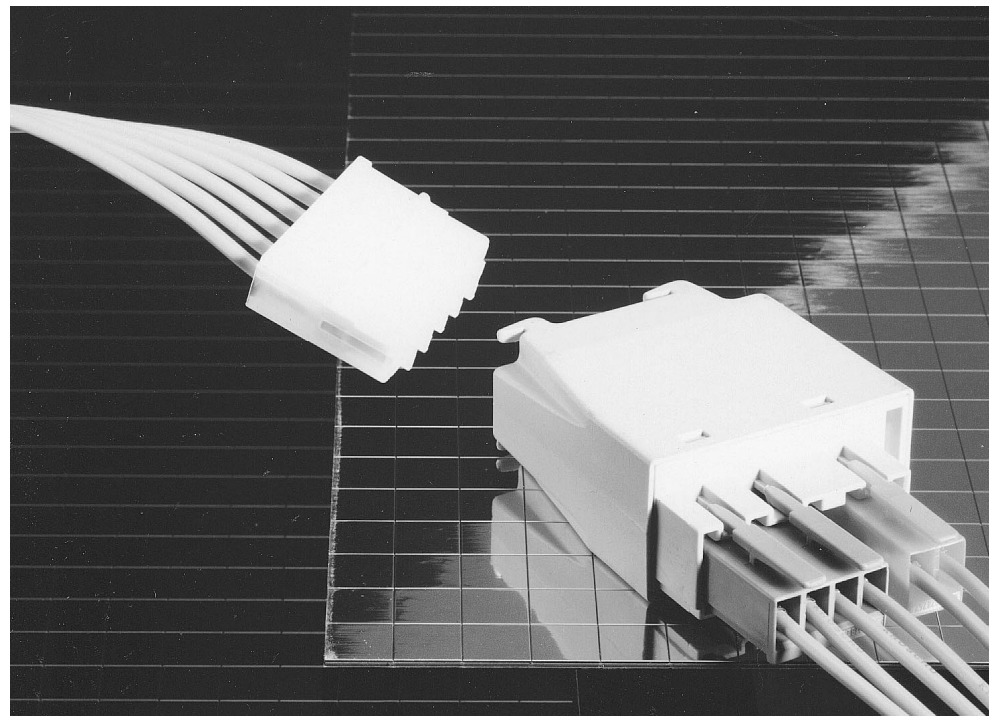

Technical Features

Centerline:
5.0 mm

Available Number of Positions:
2- to 12-positions

Housing Material:
Polyamide PA 6.6

Contact Material:
CuSn, CuFe

Contact Finish:
Tin Plated, Silver Plated

Wire Size Range:
from 0.5 to 2.5mm²

Wire Size Diameter:
from 2.0 to 3.3mm

Temperature Range:
-40°C to +110°C

Current Voltage:
220 V_~

Current Rating:
max. 16 A
Standard Timer: 6 A
Power Timer: 16 A

Mating Force Contact:
≤ 15 N

Unmating Force:
≤ 8 N

Air and Creepage Distance:
≥ 3.0mm

Track Resistance:
PTI 250

Glow Wire Test:
850°C

Contacts made for Tabs according:-
DIN 46244
(6.3 x 0.8mm / 4.8 x 0.8mm)
DIN 46343 Part 2 and 3

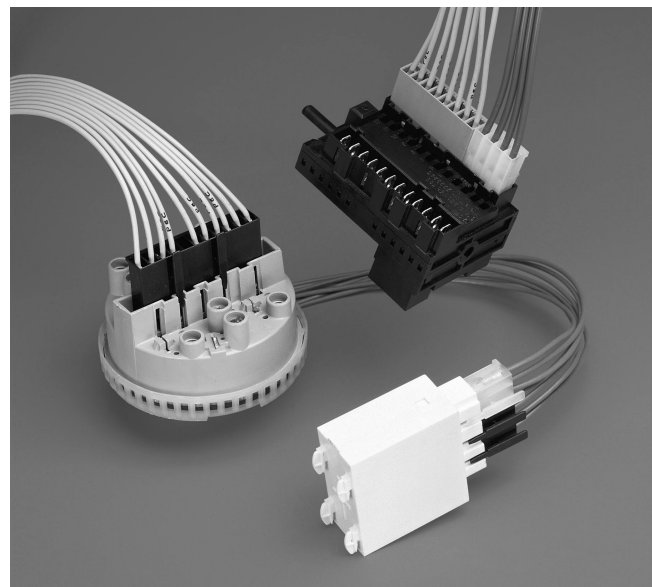

Interior and Exterior Locking

2
RAST 5

Interior Locking

Connection to the Components according RAST 5 Standard

- 1 Connected Timer Contact
- 2 Standard Timer Housing with Interior Locking
- 3 Keying
- 4 Polarisation
- 5 Locking Latch
- 6 Cover (Secondary Locking)
- 7 RAST 5 Tab Array

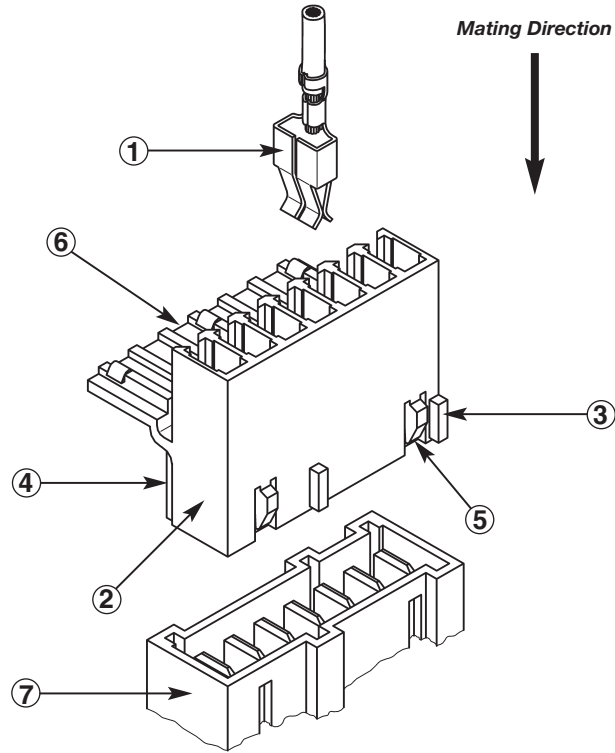

Exterior Locking

Connection to the Components according RAST 5 Standard

- 1 Connected Timer Contact
- 2 Standard Timer Housing with Exterior Locking
- 3 Keying
- 4 Polarisation
- 5 Locking Latch
- 6 RAST 5 Tab Array

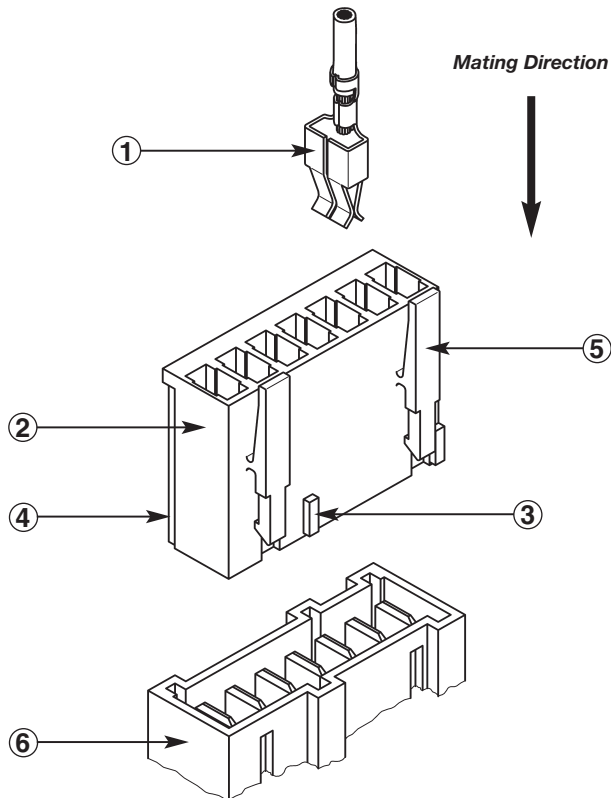

Keying Plan and Housings

Keying Plan from Mating Direction

- 1 Locking Latch
- 2 Keying Rib
- 3 Keying Rib between Cavity
- 4 Slanted Keying Rib
- 5 Polarisation Rib
- 6 Cavity Number

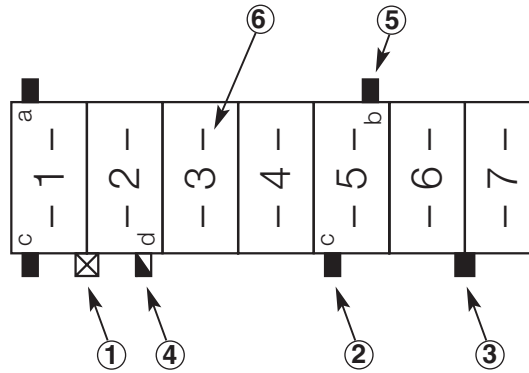

AMP Standard Timer Housings 2 Position Rast 5 Variations

| Keying Version Colour | RAST 5 Version | Part Numbers | | Packaging Unit |
|--------------------------|----------------|-----------------------|-----------------------|----------------|
| | | with Interior Locking | with Exterior Locking | |
| 02-A Natural | | 928344-2 | 6-928247-2 | 2.500 / 2.500 |
| 02-B Black | | 2-928344-2 | 928247-2 | 2.500 / 3.000 |
| 02-C Grey | | 3-964951-2 | 8-928247-2 | 2.500 / 2.500 |
| 02-D Blue | | — | 964983-2 | 2.500 |
| 02-E Green | | 6-928344-2 | 5-928247-2 | 2.500 / 2.500 |
| 02-G Violet | | 5-928344-2 | 2-964983-2 | 2.500 / 2.500 |
| 02-H Brown | | 3-928344-2 | — | 2.500 |
| 02-I Orange | | 2-964951-2 | 3-928247-2 | 2.500 / 2.500 |

Bold Part Numbers are Preferred Types

Housings

AMP Standard Timer Housings 2 Position Rast 5 Variations (continued)

| Keying Version Colour | RAST 5 Version | Part Numbers | | Packaging Unit |
|--------------------------|----------------|-----------------------|-----------------------|----------------|
| | | with Interior Locking | with Exterior Locking | |
| 02-K Yellow-Green | | — | 4-928247-2 | 2.500 |
| 02-L Natural | | 928343-2 | — | 3.000 |
| 02-M Ultramarine-Blue | | — | 3-964983-2 | 2.500 |
| 02-O Pink | | 964951-2 | 2-928247-2 | 2.500 / 2.500 |
| 02-P Purple | | — | 7-928247-2 | 2.500 |
| 02-Q Turquoise | | 4-928344-2 | — | 2.500 |

Bold Part Numbers are Preferred Types

AMP Standard Timer Housings 2 Position Special Variations

| Colour | Version | Part Numbers | | Packaging Unit |
|---------|---------|-----------------------|-----------------------|----------------|
| | | with Interior Locking | with Exterior Locking | |
| Natural | | 7-927740-2 | 9-928247-2 | 5.000 |
| Natural | | 964768-1 | — | 5.000 |

Housings

AMP Standard Timer Housings 3 Position Rast 5 Variations

| Keying Version Colour | RAST 5 Version | Part Numbers | | Packaging Unit |
|--------------------------|----------------|-----------------------|-----------------------|----------------|
| | | with Interior Locking | with Exterior Locking | |
| 03-A Natural | | 928344-3 | — | 3.000 |
| 03-B Black | | — | 964983-3 | 2.500 |
| 03-D Blue | | — | 3-928247-3 | 2.500 |
| 03-G Violet | | — | 2-928247-3 | 2.500 |
| 03-H Brown | | — | 4-928247-3 | 2.500 |
| 03-K Yellow-Green | | — | 2-964983-3 | 2.500 |

Bold Part Numbers are Preferred Types

Housings

AMP Standard Timer Housings 3 Position Special Variations

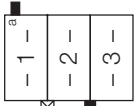
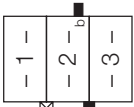
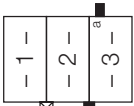
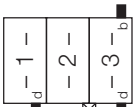
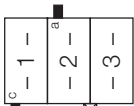
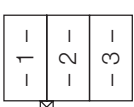
| Colour | Version | Part Numbers | | Packaging Unit |
|---------|---|-----------------------|-----------------------|----------------|
| | | with Interior Locking | with Exterior Locking | |
| Natural |  | 928343-3 | — | 3.000 |
| Black |  | 2-928343-3 | — | 3.000 |
| Grey |  | 3-928343-3 | — | 3.000 |
| Yellow |  | — | 928247-3 | 2.000 |
| Grey |  | 2-928344-3 | — | 2.500 |
| Natural |  | — | 5-928247-3 | 2.500 |

Bold Part Numbers are Preferred Types

2
Part 5

Housings

AMP Standard Timer Housings 4 Position Rast 5 Variations

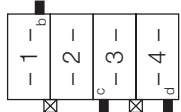
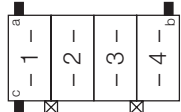
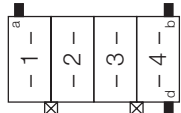
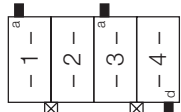
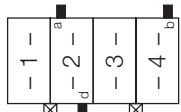
| Keying Version Colour | RAST 5 Version | Part Numbers | | Packaging Unit |
|--------------------------|--|-----------------------|-----------------------|----------------|
| | | with Interior Locking | with Exterior Locking | |
| 04-A Natural |  | 928344-4 | 4-928247-4 | 2.000 / 1.250 |
| 04-B Black |  | — | 5-928247-4 | 1.250 |
| 04-C Grey |  | 3-928344-4 | 928247-4 | 2.000 / 1.250 |
| 04-F White |  | — | 2-928247-4 | 1.250 |
| 03-G Violet |  | — | 3-928247-4 | 1.250 |

AMP Standard Timer Housings 4 Position Special Variations

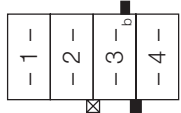
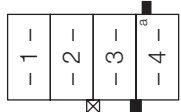
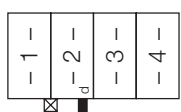
| Colour | Version | Part Numbers | | Packaging Unit |
|---------|---|-----------------------|-----------------------|----------------|
| | | with Interior Locking | with Exterior Locking | |
| Natural |  | 928343-4 | — | 2.500 |
| Black |  | 2-928343-4 | — | 2.500 |
| Black |  | 3-928344-4 | — | 2.500 |

Bold Part Numbers are Preferred Types

Housings

AMP Standard Timer Housings 5 Position Rast 5 Variations

| Keying Version Colour | RAST 5 Version | Part Numbers | | Packaging Unit |
|--------------------------|----------------|-----------------------|-----------------------|----------------|
| | | with Interior Locking | with Exterior Locking | |
| 05-B Black | | — | 2-928247-5 | 1.000 |
| 05-D Blue | | — | 3-928247-5 | 1.000 |

AMP Standard Timer Housings 5 Position Special Variations

| Colour | Version | Part Numbers | | Packaging Unit |
|---------|---------|-----------------------|-----------------------|----------------|
| | | with Interior Locking | with Exterior Locking | |
| Natural | | 928343-5 | — | 1.000 |
| Black | | 2-928343-5 | — | 1.000 |
| Green | | — | 5-928247-5 | 1.250 |
| Yellow | | — | 4-928247-5 | 1.250 |
| Natural | | — | 6-928247-5 | 1.250 |

Bold Part Numbers are Preferred Types

Housings



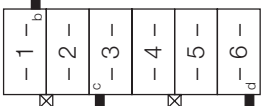
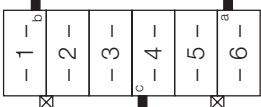
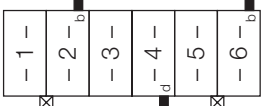
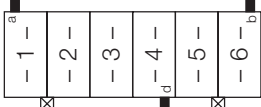

AMP Standard Timer Housings 6 Position Rast 5 Variations

| Keying Version Colour | RAST 5 Version | Part Numbers | | Packaging Unit |
|--------------------------|---|-----------------------|-----------------------|----------------|
| | | with Interior Locking | with Exterior Locking | |
| 06-A Natural |  | — | 964983-6 | 2.500 |
| 06-C Grey |  | — | 928247-6 | 1.000 |
| 06-D Blue |  | — | 2-928247-6 | 1.000 |
| 06-E Green |  | — | 3-928247-6 | 1.000 |

Bold Part Numbers are Preferred Types

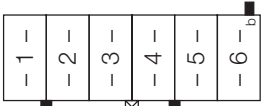
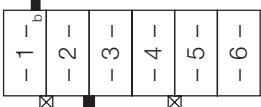
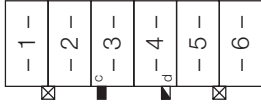
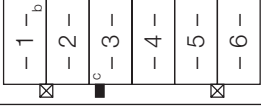
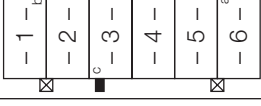
Housings

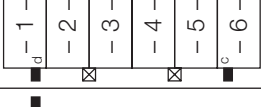
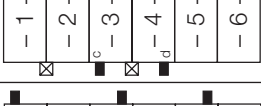
AMP Standard Timer Housings 6 Position Special Variations

| Colour | Version | Part Numbers | | Packaging Unit |
|---------|---|-----------------------|-----------------------|----------------|
| | | with Interior Locking | with Exterior Locking | |
| Natural |  | 928343-6 | — | 1.000 |
| Black |  | 2-928343-6 | — | 1.000 |
| Natural |  | 928151-6 | — | 1.500 |
| Beige |  | — | 7-928247-6 | 1.000 |
| Yellow |  | — | 4-928247-6 | 1.000 |
| Brown |  | — | 5-928247-6 | 1.000 |
| Natural |  | — | 6-928247-6 | 1.000 |
| Natural |  | 2-928344-6 | — | 1.500 |
| Green |  | 3-928344-6 | — | 1.500 |

Bold Part Numbers are Preferred Types

Housings

AMP Standard Timer Housings 7 Position Rast 5 Variations

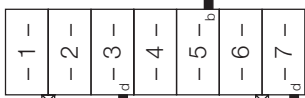
| Keying Version Colour | RAST 5 Version | Part Numbers | | Packaging Unit |
|--------------------------|---|-----------------------|-----------------------|----------------|
| | | with Interior Locking | with Exterior Locking | |
| 07-A/S Natural |  | 928151-7 | — | 1.300 |
| 07-C Grey |  | — | 928247-7 | 700 |

AMP Standard Timer Housings 7 Position Special Variations

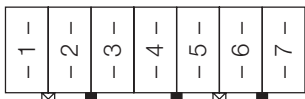
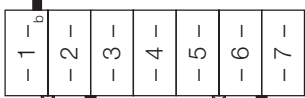
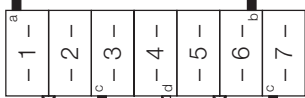
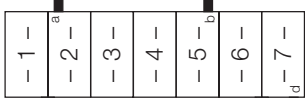
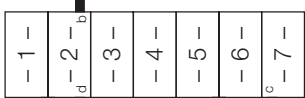
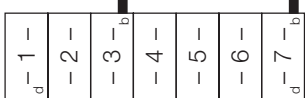
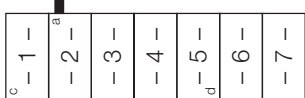
| Colour | Version | Part Numbers | | Packaging Unit |
|---------|---|-----------------------|-----------------------|----------------|
| | | with Interior Locking | with Exterior Locking | |
| Natural |  | 928343-7 | — | 500 |
| Black |  | 2-928343-7 | — | 500 |
| Natural |  | 928344-7 | — | 500 |
| Blue |  | — | 2-928247-7 | 800 |
| Green |  | 2-928151-7 | 4-928247-7 | 1.300 / 1.000 |
| Natural |  | — | 5-928247-7 | 1.000 |
| Natural |  | — | 6-928247-7 | 1.000 |

Bold Part Numbers are Preferred Types

Housings

AMP Standard Timer Housings 8 Position Rast 5 Variations

| Keying Version Colour | RAST 5 Version | Part Numbers | | Packaging Unit |
|--------------------------|---|-----------------------|-----------------------|----------------|
| | | with Interior Locking | with Exterior Locking | |
| 08-D Blue |  | — | 928247-8 | 800 |

AMP Standard Timer Housings 8 Position Special Variations

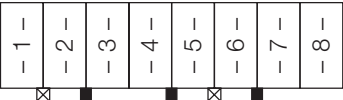
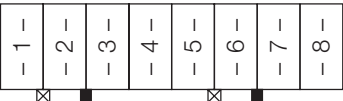
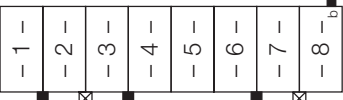
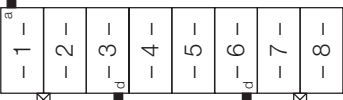
| Colour | Version | Part Numbers | | Packaging Unit |
|---------|---|-----------------------|-----------------------|----------------|
| | | with Interior Locking | with Exterior Locking | |
| Natural |  | 928343-8 | — | 1.000 |
| Black |  | 2-928343-8 | — | 1.000 |
| Grey |  | 3-928343-8 | — | 1.000 |
| Natural |  | — | 2-928247-7 | 800 |

Bold Part Numbers are Preferred Types

Housings

AMP Standard Timer Housings 9 Position Rast 5 Variations

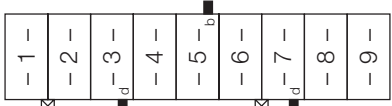
| Keying Version Colour | RAST 5 Version | Part Numbers | | Packaging Unit |
|--------------------------|---|-----------------------|-----------------------|----------------|
| | | with Interior Locking | with Exterior Locking | |
| 09-D Blue |  | — | 2-928247-9 | 600 |

AMP Standard Timer Housings 9 Position Special Variations

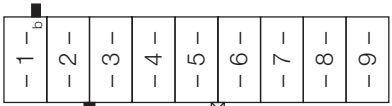
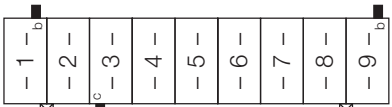
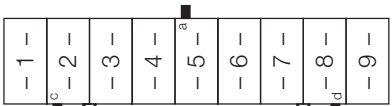
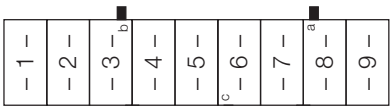
| Colour | Version | Part Numbers | | Packaging Unit |
|---------|---|-----------------------|-----------------------|----------------|
| | | with Interior Locking | with Exterior Locking | |
| Natural |  | 927740-9 | — | 1.000 |
| Natural |  | 928151-9 | — | 1.000 |
| Yellow |  | — | 928247-9 | 500 |
| Brown |  | — | 3-928247-9 | 600 |

Bold Part Numbers are Preferred Types

Housings

AMP Standard Timer Housings 10 Position Special Variations

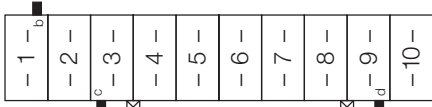
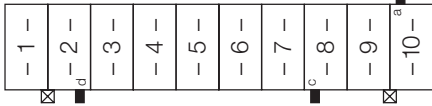
| Keying Version Colour | RAST 5 Version | Part Numbers | | Packaging Unit |
|--------------------------|---|-----------------------|-----------------------|----------------|
| | | with Interior Locking | with Exterior Locking | |
| Brown |  | — | 1-928247-0 | 1.400 |
| Grey |  | — | 2-928247-0 | 500 |

AMP Standard Timer Housings 11 Position Rast 5 Variations

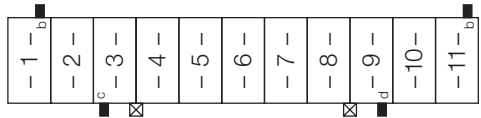
| Keying Version Colour | RAST 5 Version | Part Numbers | | Packaging Unit |
|--------------------------|--|-----------------------|-----------------------------|----------------|
| | | with Interior Locking | with Exterior Locking | |
| 11-B Black |  | — | 1-928247-1 Yellow | 1.000 |

AMP Standard Timer Housings 11 Position Special Variations

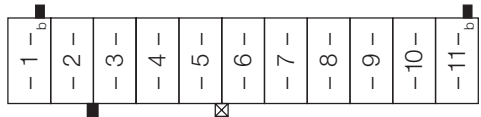
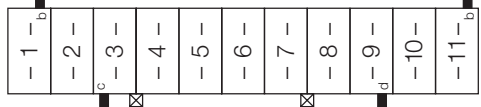
| Colour | Version | Part Numbers | | Packaging Unit |
|---------|---|-----------------------|-----------------------|----------------|
| | | with Interior Locking | with Exterior Locking | |
| Natural |  | 1-927740-1 | — | 800 |
| Blue |  | — | 2-928247-1 | 1.000 |

AMP Standard Timer Housings 12 Position Special Variations

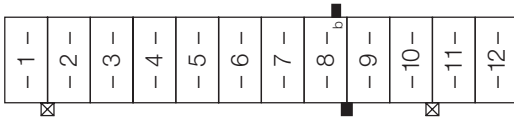
| Colour | Version | Part Numbers | | Packaging Unit |
|---------|---|-----------------------|-----------------------|----------------|
| | | with Interior Locking | with Exterior Locking | |
| Natural |  | 1-927740-2 | — | 700 |

Bold Part Numbers are Preferred Types

Standard Timer Connector and Contacts

Technical Data

Material:

Brass, Tin Plated

Mating Part:

6.3 Tab

Wire:

FLK 0.5/0.75 and 1.5mm²

Current Carrying Capacity to 6A:

1 = Wire 0.50mm², 11pos. housing

2 = Wire 0.75mm², 11pos. housing

3 = Wire 0.50mm², 2pos. housing

4 = Wire 0.75mm², 2pos. housing

Current Carrying Capacity to 16A:

5 = Wire 1.50mm², 11pos. housing

6 = Wire 1.50mm², 2pos. housing

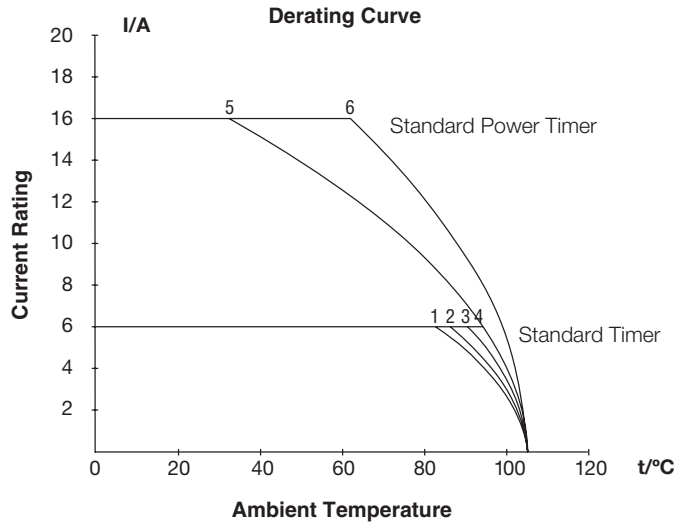

Standard Timer Contacts with One Locking Lance

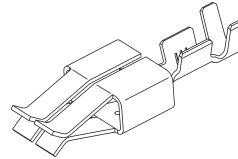

| Wire Size Range (mm ²) | Insulation Diameter Range (mm) | Material | Finish | Part Number | Packaging Unit |
|------------------------------------|--------------------------------|------------|------------|-----------------|----------------|
| 0.5–1.0 | 1.4–2.3 | CuZn/Brass | Tin Plated | 928820-1 | 3.000 |
| 1.0–2.5 | 3.0–4.3 | CuZn/Brass | Tin Plated | 926973-1 | 2.500 |

Standard Timer Contacts with Two Locking Lances

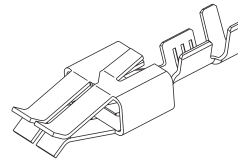

| Wire Size Range (mm ²) | Insulation Diameter Range (mm) | Material | Finish | Part Number | Packaging Unit |
|------------------------------------|--------------------------------|------------|------------|-----------------|----------------|
| 0.5–1.0 | 1.4–2.3 | CuZn/Brass | Tin Plated | 964201-1 | 3.000 |
| 1.0–2.5 | 3.0–4.3 | CuZn/Brass | Tin Plated | 964202-1 | 2.000 |

Standard Power Timer

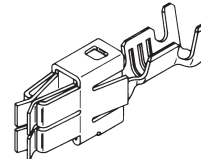

| Wire Size Range (mm ²) | Insulation Diameter Range (mm) | Material | Finish | Part Number | Packaging Unit |
|------------------------------------|--------------------------------|------------------|---------------|-----------------|----------------|
| 1.0–2.5 | 2.2–3.0 | CuFe/Copper Iron | Tin Plated | 964203-1 | 2.300 |
| 1.0–2.5 | 2.2–3.0 | CuFe/Copper Iron | Silver Plated | 964203-5 | 2.300 |
| 1.5–3.0 | max. 2 x 3.0 | CuFe/Copper Iron | Tin Plated | 964204-1 | 2.000 |
| 1.5–3.0 | max. 2 x 3.0 | CuFe/Copper Iron | Silver Plated | 964204-5 | 2.000 |

Bold Part Numbers are Preferred Types

Engineering Notes



Engineering Notes





Компания «ЭлектроПласт» предлагает заключение долгосрочных отношений при поставках импортных электронных компонентов на взаимовыгодных условиях!

Наши преимущества:

- Оперативные поставки широкого спектра электронных компонентов отечественного и импортного производства напрямую от производителей и с крупнейших мировых складов;
- Поставка более 17-ти миллионов наименований электронных компонентов;
- Поставка сложных, дефицитных, либо снятых с производства позиций;
- Оперативные сроки поставки под заказ (от 5 рабочих дней);
- Экспресс доставка в любую точку России;
- Техническая поддержка проекта, помощь в подборе аналогов, поставка прототипов;
- Система менеджмента качества сертифицирована по Международному стандарту ISO 9001;
- Лицензия ФСБ на осуществление работ с использованием сведений, составляющих государственную тайну;
- Поставка специализированных компонентов (Xilinx, Altera, Analog Devices, Intersil, Interpoint, Microsemi, Aeroflex, Peregrine, Syfer, Eurofarad, Texas Instrument, Miteq, Cobham, E2V, MA-COM, Hittite, Mini-Circuits, General Dynamics и др.);

Помимо этого, одним из направлений компании «ЭлектроПласт» является направление «Источники питания». Мы предлагаем Вам помощь Конструкторского отдела:

- Подбор оптимального решения, техническое обоснование при выборе компонента;
- Подбор аналогов;
- Консультации по применению компонента;
- Поставка образцов и прототипов;
- Техническая поддержка проекта;
- Защита от снятия компонента с производства.



Как с нами связаться

Телефон: 8 (812) 309 58 32 (многоканальный)

Факс: 8 (812) 320-02-42

Электронная почта: org@eplast1.ru

Адрес: 198099, г. Санкт-Петербург, ул. Калинина, дом 2, корпус 4, литера А.