

LDE Series

Digital low differential pressure sensors

FEATURES

- Pressure ranges from 25 to 500 Pa (0.1 to 2 inH₂O)
- Pressure sensor based on thermal micro-flow measurement
- High flow impedance
 - very low flow-through leakage
 - high immunity to dust and humidity
 - no loss in sensitivity using long tubing
- Calibrated and temperature compensated
- Unique offset autozeroing feature ensuring superb long-term stability
- Offset accuracy better than 0.2 %FS
- Total accuracy better than 0.5 %FS typical
- Analog output and digital SPI interface
- RoHS and REACH compliant
- Quality Management System according to EN ISO 13485 and EN ISO 9001

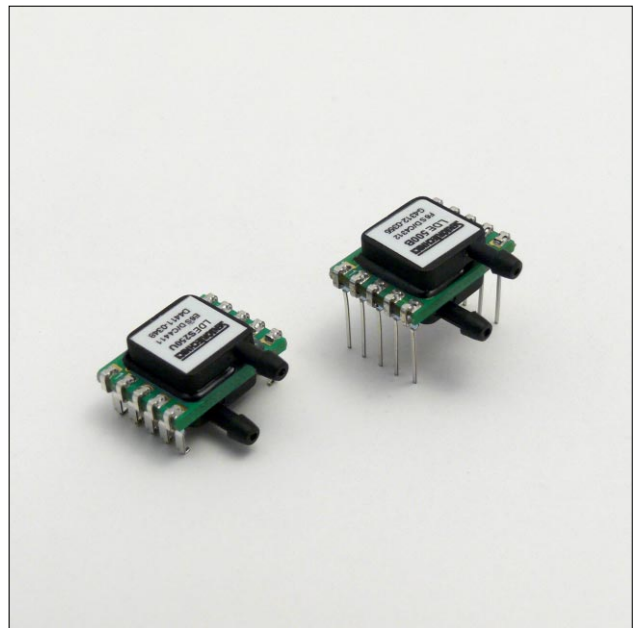

MEDIA COMPATIBILITY

Air and other non-corrosive gases

SPECIFICATIONS

Maximum ratings

Supply voltage V_s	
LDE...3...	2.70 ... 3.60 V_{DC}
LDE...6...	4.75 ... 5.25 V_{DC}

Output current 1 mA

Lead specifications

Average preheating temperature gradient	2.5 K/s
Soak time	ca. 3 min
Time above 217 °C	50 s
Time above 230 °C	40 s
Time above 250 °C	15 s
Peak temperature	260 °C
Cooling temperature gradient	-3.5 K/s

Temperature ranges

Compensated	0 ... +70 °C
Operating	-20 ... +80 °C
Storage	-40 ... +80 °C

Humidity limits (non-condensing) 97 %RH

Vibration¹ 20 g

Mechanical shock² 500 g

ELECTRICAL CONNECTION³

Top-down view

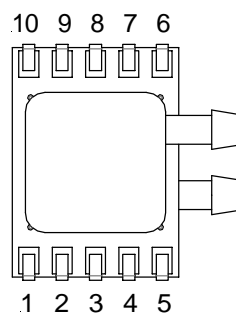

Pin	Function
1	Reserved
2	V_s
3	GND
4	Vout
5	Vout
6	SCLK
7	MOSI
8	MISO
9	/CS
10	Reserved

There are three use cases that will change the manner in which the LDE sensor is connected in-circuit. For detailed pin connections see page 11.

Specification notes:

1. Sweep 20 to 2000 Hz, 8 min, 4 cycles per axis, MIL-STD-883, Method 2007.
2. 5 shocks, 3 axes, MIL-STD-883E, Method 2002.4.
3. The maximum voltage applied to pin 1 and pins 6 through 10 should not exceed $V_s + 0.3$ V.

LDE Series

Digital low differential pressure sensors

PRESSURE SENSOR CHARACTERISTICS

Part no.	Operating pressure	Proof pressure ⁴	Burst pressure ⁴
LDES025U...	0...25 Pa / 0...0.25 mbar (0.1 inH ₂ O)	2 bar (30 psi)	5 bar (75 psi)
LDES050U...	0...50 Pa / 0...0.5 mbar (0.2 inH ₂ O)		
LDES100U...	0...100 Pa / 0...1 mbar (0.4 inH ₂ O)		
LDES250U...	0...250 Pa / 0...2.5 mbar (1 inH ₂ O)		
LDES500U...	0...500 Pa / 0...5 mbar (2 inH ₂ O)		
LDES025B...	0...±25 Pa / 0...±0.25 mbar (±0.1 inH ₂ O)		
LDES050B...	0...±50 Pa / 0...±0.5 mbar (±0.2 inH ₂ O)		
LDES100B...	0...±100 Pa / 0...±1 mbar (±0.4 inH ₂ O)		
LDES250B...	0...±250 Pa / 0...±2.5 mbar (±1 inH ₂ O)		
LDES500B...	0...±500 Pa / 0...±5 mbar (±2 inH ₂ O)		

GAS CORRECTION FACTORS⁵

Gas type	Correction factor
Dry air	1.0
Oxygen (O ₂)	1.07
Nitrogen (N ₂)	0.97
Argon (Ar)	0.98
Carbon dioxide (CO ₂)	0.56

Specification notes (cont.):

4. The max. common mode pressure is 5 bar.
5. For example with a LDES500... sensor measuring CO₂ gas, at full-scale output the actual pressure will be 500 Pa x 0.56 = 280 Pa.

$$\Delta P_{\text{eff}} = \Delta P_{\text{sensor}} \times \text{gas correction factor}$$

$$\Delta P_{\text{eff}} = \text{True differential pressure}$$

$$\Delta P_{\text{sensor}} = \text{Differential pressure as indicated by output voltage}$$

LDE Series

Digital low differential pressure sensors

PERFORMANCE CHARACTERISTICS⁶

LDE...6...

($V_S=5.0 V_{DC}$, $T_A=20\text{ °C}$, $P_{Abs}=1\text{ bara}$, calibrated in air, output signals analog and digital are **non-ratiometric** to V_S)

all 25 Pa and 50 Pa devices

Characteristics	Min.	Typ.	Max.	Unit
Noise level		±0.01		Pa
Offset warm-up shift			less than noise	
Offset long term stability ⁷		±0.05	±0.1	Pa/year
Offset repeatability		±0.01		Pa
Span repeatability ^{10, 11}		±0.25		% of reading
Current consumption (no load) ⁸		7	8	mA
Response time (t_{63})		5		ms
Power-on time			25	

Digital output

Characteristics	Min.	Typ.	Max.	Unit	
Scale factor (digital output) ⁹	0...25 / 0...±25 Pa	1200		counts/Pa	
	0...50 / 0...±50 Pa	600			
Zero pressure offset accuracy ¹⁰		±0.1	±0.2	%FSS	
Span accuracy ^{10, 11}		±0.4	±0.75	% of reading	
Thermal effects	Offset	5...55 °C		±0.2	%FSS
		0...70 °C		±0.4	
	Span	5...55 °C	±1	±1.75	% of reading
		0...70 °C	±2	±2.75	

Analog output (unidirectional devices)

Characteristics	Min.	Typ.	Max.	Unit	
Zero pressure offset	0.49	0.50	0.51	V	
Full scale output		4.50			
Span accuracy ^{10, 11}		±0.4	±0.75	% of reading	
Thermal effects	Offset	5...55 °C		±15	mV
		0...70 °C		±30	
	Span	5...55 °C	±1.25	±2	% of reading
		0...70 °C	±2	±2.75	

Analog output (bidirectional devices)

Characteristics	Min.	Typ.	Max.	Unit	
Zero pressure offset	2.49	2.50	2.51	V	
Output	at max. specified pressure	4.50			
	at min. specified pressure	0.50			
Span accuracy ^{10, 11}		±0.4	±0.75	% of reading	
Thermal effects	Offset	5...55 °C		±15	mV
		0...70 °C		±30	
	Span	5...55 °C	±1.25	±2	% of reading
		0...70 °C	±2	±2.75	

LDE Series

Digital low differential pressure sensors

PERFORMANCE CHARACTERISTICS⁶

LDE...6...

($V_S=5.0 V_{DC}$, $T_A=20\text{ °C}$, $P_{Abs}=1\text{ bara}$, calibrated in air, output signals analog and digital are **non-ratiometric** to V_S)

all 100 Pa, 250 Pa and 500 Pa devices

Characteristics	Min.	Typ.	Max.	Unit
Noise level		±0.02		Pa
Offset warm-up shift			less than noise	
Offset long term stability ⁷		±0.05	±0.1	%FSS/year
Offset repeatability ¹²		±0.02		Pa
Span repeatability ^{10, 11}		±0.25		% of reading
Current consumption (no load) ⁸		7	8	mA
Response time (t_{63})		5		ms
Power-on time			25	

Digital output

Characteristics	Min.	Typ.	Max.	Unit	
Scale factor (digital output) ⁹	0...100 / 0...±100 Pa	300		counts/Pa	
	0...250 / 0...±250 Pa	120			
	0...500 / 0...±500 Pa	60			
Zero pressure offset accuracy ¹⁰		±0.05	±0.1	%FSS	
Span accuracy ^{10, 11}		±0.4	±0.75	% of reading	
Thermal effects	Offset	5...55 °C		±0.1	%FSS
		0...70 °C		±0.2	
	Span	5...55 °C	±1	±1.75	% of reading
		0...70 °C	±2	±2.75	

Analog output (unidirectional devices)

Characteristics	Min.	Typ.	Max.	Unit	
Zero pressure offset	0.49	0.50	0.51	V	
Full scale output		4.50			
Span accuracy ^{10, 11}		±0.4	±0.75	% of reading	
Thermal effects	Offset	5...55 °C		±10	mV
		0...70 °C		±12	
	Span	5...55 °C	±1	±1.75	% of reading
		0...70 °C	±2	±2.75	

Analog output (bidirectional devices)

Characteristics	Min.	Typ.	Max.	Unit	
Zero pressure offset	2.49	2.50	2.51	V	
Output	at max. specified pressure	4.50			
	at min. specified pressure	0.50			
Span accuracy ^{10, 11}		±0.4	±0.75	% of reading	
Thermal effects	Offset	5...55 °C		±10	mV
		0...70 °C		±12	
	Span	5...55 °C	±1	±1.75	% of reading
		0...70 °C	±2	±2.75	

LDE Series

Digital low differential pressure sensors

PERFORMANCE CHARACTERISTICS⁶

LDE...3...

($V_S=3.0 V_{DC}$, $T_A=20\text{ °C}$, $P_{Abs}=1\text{ bara}$, calibrated in air, output signals analog and digital are **non-ratiometric** to V_S)

all 25 Pa and 50 Pa devices

Characteristics	Min.	Typ.	Max.	Unit
Noise level		±0.01		Pa
Offset warm-up shift			less than noise	
Offset long term stability ⁷		±0.05	±0.1	Pa/year
Offset repeatability		±0.01		Pa
Span repeatability ^{10, 11}		±0.25		% of reading
Current consumption (no load) ⁸		14	16	mA
Response time (t_{63})		5		ms
Power-on time			25	

Digital output

Characteristics	Min.	Typ.	Max.	Unit	
Scale factor (digital output) ⁹	0...25 / 0...±25 Pa	1200		counts/Pa	
	0...50 / 0...±50 Pa	600			
Zero pressure offset accuracy ¹⁰		±0.1	±0.2	%FSS	
Span accuracy ^{10, 11}		±0.4	±0.75	% of reading	
Thermal effects	Offset	5...55 °C		±0.2	%FSS
		0...70 °C		±0.4	
	Span	5...55 °C	±1	±1.75	% of reading
		0...70 °C	±2	±2.75	

Analog output (unidirectional devices)

Characteristics	Min.	Typ.	Max.	Unit	
Zero pressure offset	0.29	0.30	0.31	V	
Full scale output		2.70			
Span accuracy ^{10, 11}		±0.4	±0.75	% of reading	
Thermal effects	Offset	5...55 °C		±15	mV
		0...70 °C		±30	
	Span	5...55 °C	±1.25	±2	% of reading
		0...70 °C	±2	±2.75	

Analog output (bidirectional devices)

Characteristics	Min.	Typ.	Max.	Unit	
Zero pressure offset	1.49	1.50	1.51	V	
Output	at max. specified pressure	2.70			
	at min. specified pressure	0.30			
Span accuracy ^{10, 11}		±0.4	±0.75	% of reading	
Thermal effects	Offset	5...55 °C		±15	mV
		0...70 °C		±30	
	Span	5...55 °C	±1.25	±2	% of reading
		0...70 °C	±2	±2.75	

LDE Series

Digital low differential pressure sensors

PERFORMANCE CHARACTERISTICS⁶

LDE...3...

($V_S=3.0 V_{DC}$, $T_A=20\text{ °C}$, $P_{Abs}=1\text{ bara}$, calibrated in air, output signals analog and digital are **non-ratiometric** to V_S)

all 100 Pa, 250 Pa and 500 Pa devices

Characteristics	Min.	Typ.	Max.	Unit
Noise level		±0.02		Pa
Offset warm-up shift			less than noise	
Offset long term stability ⁷		±0.05	±0.1	%FSS/year
Offset repeatability ¹²		±0.02		Pa
Span repeatability ^{10, 11}		±0.25		% of reading
Current consumption (no load) ⁸		14	16	mA
Response time (t_{63})		5		ms
Power-on time			25	

Digital output

Characteristics	Min.	Typ.	Max.	Unit	
Scale factor (digital output) ⁹	0...100 / 0...±100 Pa	300		counts/Pa	
	0...250 / 0...±250 Pa	120			
	0...500 / 0...±500 Pa	60			
Zero pressure offset accuracy ¹⁰		±0.05	±0.1	%FSS	
Span accuracy ^{10, 11}		±0.4	±0.75	% of reading	
Thermal effects	Offset	5...55 °C		±0.1	%FSS
		0...70 °C		±0.2	
	Span	5...55 °C	±1	±1.75	% of reading
		0...70 °C	±2	±2.75	

Analog output (unidirectional devices)

Characteristics	Min.	Typ.	Max.	Unit	
Zero pressure offset	0.29	0.30	0.31	V	
Full scale output		2.70			
Span accuracy ^{10, 11}		±0.4	±0.75	% of reading	
Thermal effects	Offset	5...55 °C		±10	mV
		0...70 °C		±12	
	Span	5...55 °C	±1	±1.75	% of reading
		0...70 °C	±2	±2.75	

Analog output (bidirectional devices)

Characteristics	Min.	Typ.	Max.	Unit	
Zero pressure offset	1.49	1.50	1.51	V	
Output	at max. specified pressure	2.70			
	at min. specified pressure	0.30			
Span accuracy ^{10, 11}		±0.4	±0.75	% of reading	
Thermal effects	Offset	5...55 °C		±10	mV
		0...70 °C		±12	
	Span	5...55 °C	±1	±1.75	% of reading
		0...70 °C	±2	±2.75	

PERFORMANCE CHARACTERISTICS (cont.)

Total accuracy¹³

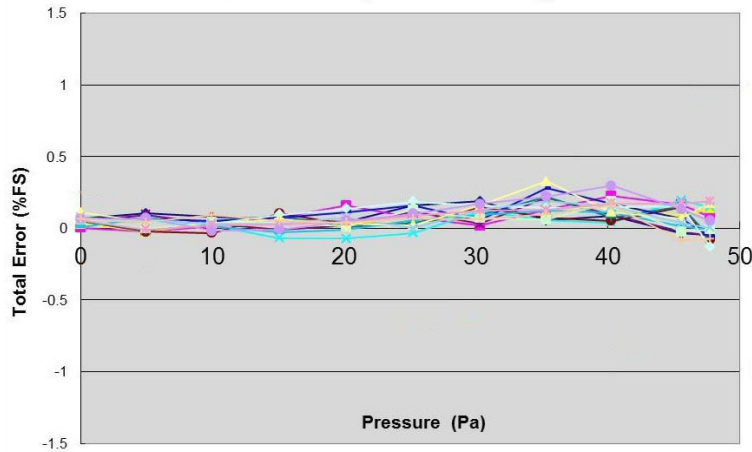

Fig. 1: Typical total accuracy plot of 16 LDE 50 Pa sensors @ 25 °C (typical total accuracy better than 0.5 %FS)

Offset long term stability

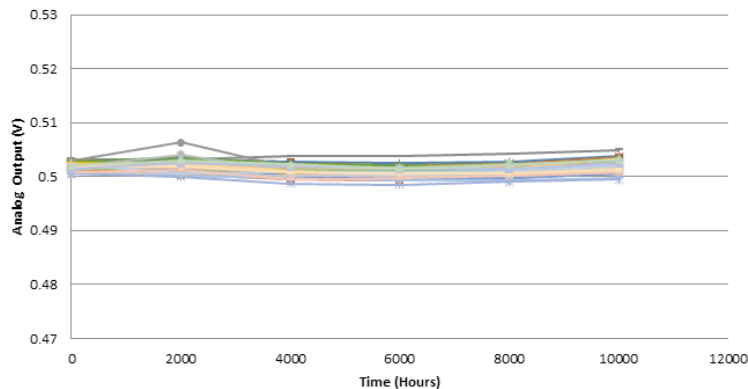

Fig. 2: Offset long term stability for LDE 250 Pa sensors after 10 000 hours @ 85°C powered, equivalent to over 43.5 years @ 25 °C (better than ±2 mV / ±0.125 Pa)

Specification notes (cont.):

6. The sensor is calibrated with a common mode pressure of 1 bar absolute. Due to the mass flow based measuring principle, variations in absolute common mode pressure need to be compensated according to the following formula:

$$\Delta P_{\text{eff}} = \Delta P_{\text{sensor}} \times \frac{1 \text{ bar}_a}{P_{\text{abs}}}$$

ΔP_{eff} = True differential pressure
 ΔP_{sensor} = Differential pressure as indicated by output voltage
 P_{abs} = Current absolute common mode pressure

7. Figure based on accelerated lifetime test of 10 000 hours at 85 °C biased burn-in.
8. Please contact First Sensor for low power options.
9. The digital output signal is a signed, two's complement integer. Negative pressures will result in a negative output.
10. Zero pressure offset accuracy and span accuracy are uncorrelated uncertainties. They can be added according to the principles of error propagation.
11. Span accuracy below 10 % of full scale is limited by the intrinsic noise of the sensor.
12. Typical value for 250 Pa sensors.
13. Total accuracy is the combined error from offset and span calibration, non-linearity, repeatability and pressure hysteresis.

SPI - SERIAL PERIPHERAL INTERFACE

Note: It is important to adhere to the communication protocol in order to avoid damage to the sensor.

Introduction

The LDE serial interface is a high-speed synchronous data input and output communication port. The serial interface operates using a standard 4-wire SPI bus. The LDE device runs in SPI mode 0, which requires the clock line SCLK to idle low (CPOL = 0), and for data to be sampled on the leading clock edge (CPHA = 0). Figure 5 illustrates this mode of operation.

Care should be taken to ensure that the sensor is properly connected to the master microcontroller. Refer to the manufacturer's datasheet for more information regarding physical connections.

Application circuit

The use of pull-up resistors is generally unnecessary for SPI as most master devices are configured for push-pull mode. If pull-up resistors are required for use with 3 V LDE devices, however, they should be greater than 50 k Ω .

There are, however, some cases where it may be helpful to use 33 Ω series resistors at both ends of the SPI lines, as shown in Figure 3. Signal quality may be further improved by the addition of a buffer as shown in Figure 4. These cases include multiple slave devices on the same bus segment, using a master device with limited driving capability and long SPI bus lines.

If these series resistors are used, they must be physically placed as close as possible to the pins of the master and slave devices.

Signal control

The serial interface is enabled by asserting /CS low. The serial input clock, SCLK, is gated internally to begin accepting the input data at MOSI, or sending the output data on MISO. When /CS rises, the data clocked into MOSI is loaded into an internal register.

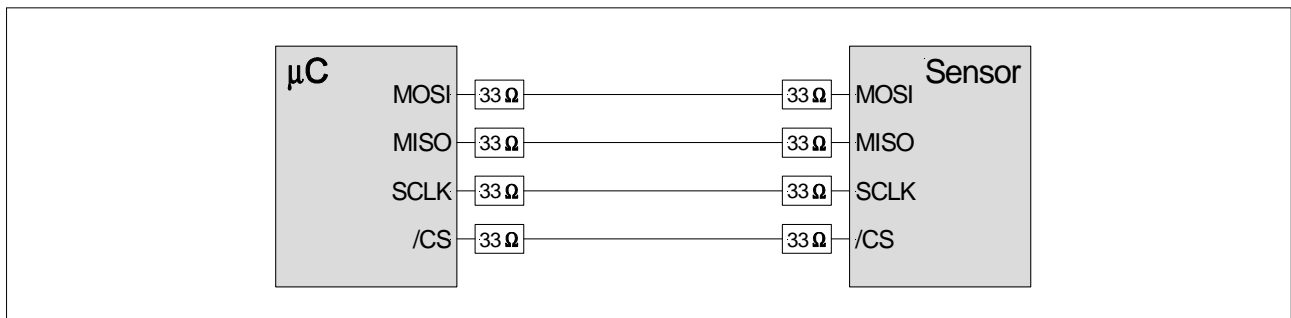

Fig. 3: Resistors at both ends of the SPI lines

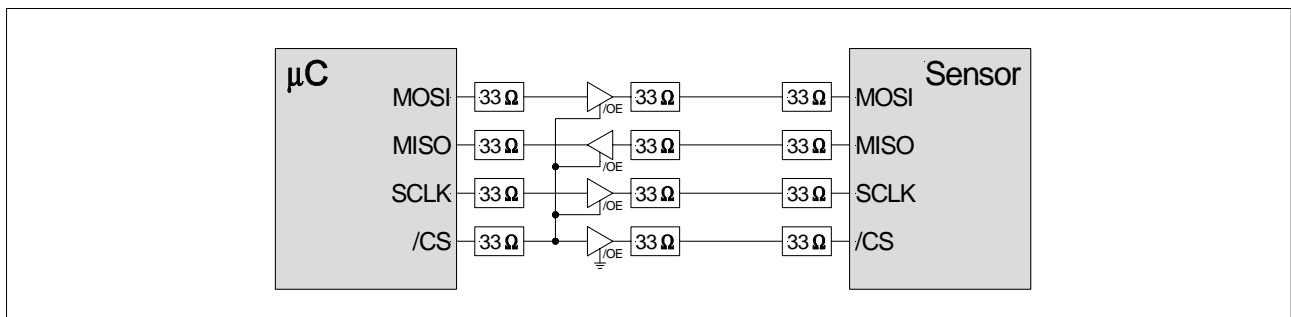

Fig. 4: Addition of a buffer

LDE Series

Digital low differential pressure sensors

SPI - SERIAL PERIPHERAL INTERFACE (cont.)

Note: It is important to adhere to the communication protocol in order to avoid damage to the sensor.

Data read

When powered on, the sensor begins to continuously measure pressure. To initiate data transfer from the sensor, the following three unique bytes must be written sequentially, MSB first, to the MOSI pin (see Figure 5):

Step	Hexadecimal	Binary	Description
1	0x2D	B00101101	Poll current pressure measurement
2	0x14	B00010100	Send result to data register
3	0x98	B10011000	Read data register

The entire 16 bit content of the LDE register is then read out on the MISO pin, MSB first, by applying 16 successive clock pulses to SCLK with /CS asserted low. Note that the value of the LSB is held at zero for internal signal processing purposes. This is below the noise threshold of the sensor and thus its fixed value does not affect sensor performance and accuracy.

From the digital sensor output the actual pressure value can be calculated as follows:

$$\text{pressure [Pa]} = \frac{\text{digital output [counts]}}{\text{scale factor} \left[\frac{\text{counts}}{\text{Pa}} \right]}$$

For example, for a ± 250 Pa sensor (LDES250B...) with a scale factor of 120 a digital output of 30 000 counts (7530'h) calculates to a positive pressure of 250 Pa. Similarly, a digital output of -30 000 counts (8AD0'h) calculates to a negative pressure of -250 Pa.

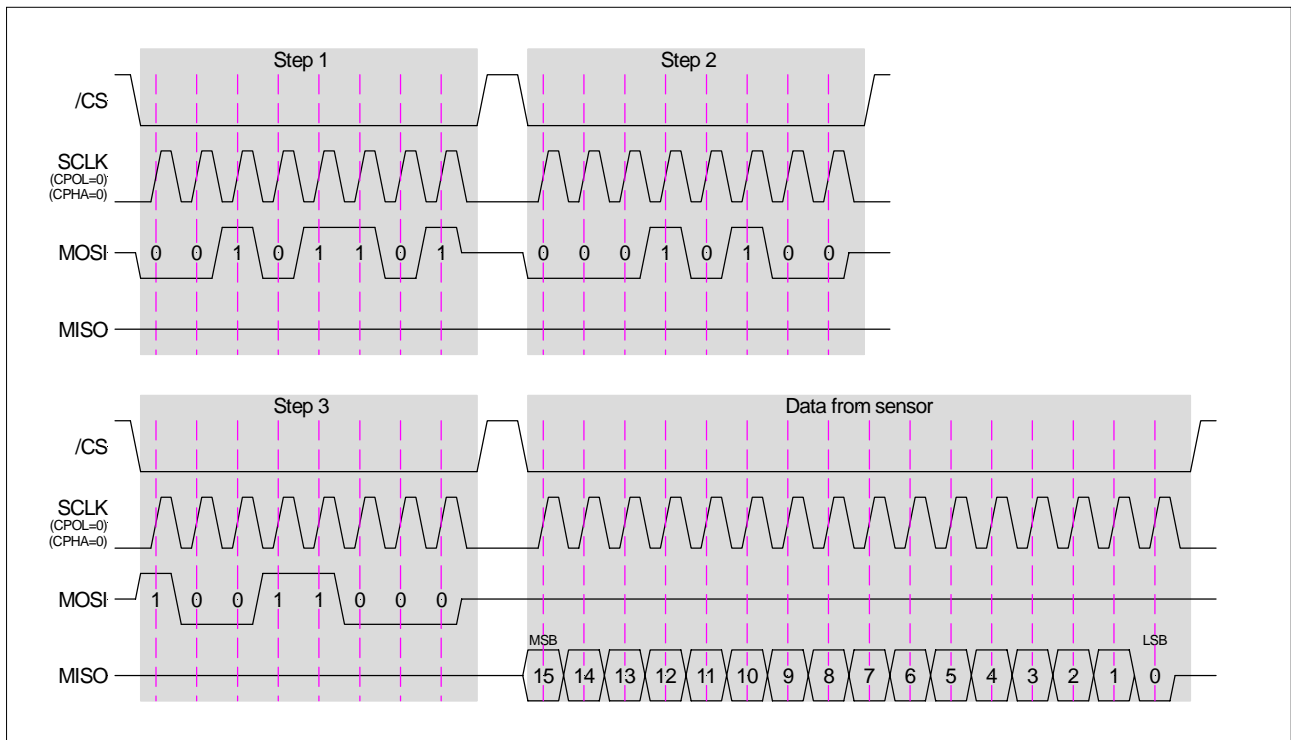

Fig. 5: SPI data transfer

LDE Series

Digital low differential pressure sensors

Interface specification

Parameter	Symbol	Conditions	Min.	Typ.	Max.	Unit
External clock frequency	f_{ECLK}	$V_{CKSEL}=0$	Min.	0.2		MHz
			Max.	5		
External master clock input low time	$t_{ECLKIN LO}$	$t_{ECLK}=1/f_{ECLK}$	40		60	% t_{ECLK}
External master clock input high time	$t_{ECLKIN HI}$	$t_{ECLK}=1/f_{ECLK}$	40		60	
SCLK setup to falling edge /CS	t_{SC}		30			ns
/CS falling edge to SCLK rising edge setup time	t_{CSS}		30			
/CS idle time	t_{CSI}	$f_{CLK}=4 \text{ MHz}$	1.5			μs
SCLK falling edge to data valid delay	t_{DO}	$C_{LOAD}=15 \text{ pF}$			80	ns
Data valid to SCLK rising edge setup time	t_{DS}		30			
Data valid to SCLK rising edge hold time	t_{DH}		30			
SCLK high pulse width	t_{CH}		100			
SCLK low pulse width	t_{CL}		100			
/CS rising edge to SCLK rising edge hold time	t_{CSH}		30			
/CS falling edge to output enable	t_{DV}	$C_{LOAD}=15 \text{ pF}$			25	
/CS rising edge to output disable	t_{TR}	$C_{LOAD}=15 \text{ pF}$			25	
LDE...6... (5 V supply)						
Maximum output load capacitance	C_{LOAD}	$R_{LOAD}=\infty$, phase margin $>55^\circ$		200		pF
Input voltage, logic HIGH	V_{IH}		$0.8 \times V_S$		$V_S+0.3$	V
Input voltage, logic LOW	V_{IL}				$0.2 \times V_S$	
Output voltage, logic HIGH	V_{OH}	$R_{LOAD}=\infty$	$V_S-0.1$			
		$R_{LOAD}=2 \text{ k}\Omega$	$V_S-0.15$			
Output voltage, logic LOW	V_{OL}	$R_{LOAD}=\infty$			0.5	
		$R_{LOAD}=2 \text{ k}\Omega$			0.2	
LDE...3... (3 V supply) ¹³						
Maximum output load capacitance	C_{LOAD}	$R_{LOAD}=1 \text{ k}\Omega$		15		pF
Input voltage, logic HIGH	V_{IH}		$0.65 \times V_S$		$V_S+0.3$	V
Input voltage, logic LOW	V_{IL}				$0.35 \times V_S$	
Output voltage, logic HIGH	V_{OH}	$I_O=-20 \mu\text{A}$	$V_S-0.4$			
Output voltage, logic LOW	V_{OL}	$I_O=20 \mu\text{A}$			0.4	

Specification notes (cont.):

13. For correct operation of LDE...3... devices, the device driving the SPI bus must have a minimum drive capability of $\pm 2 \text{ mA}$.

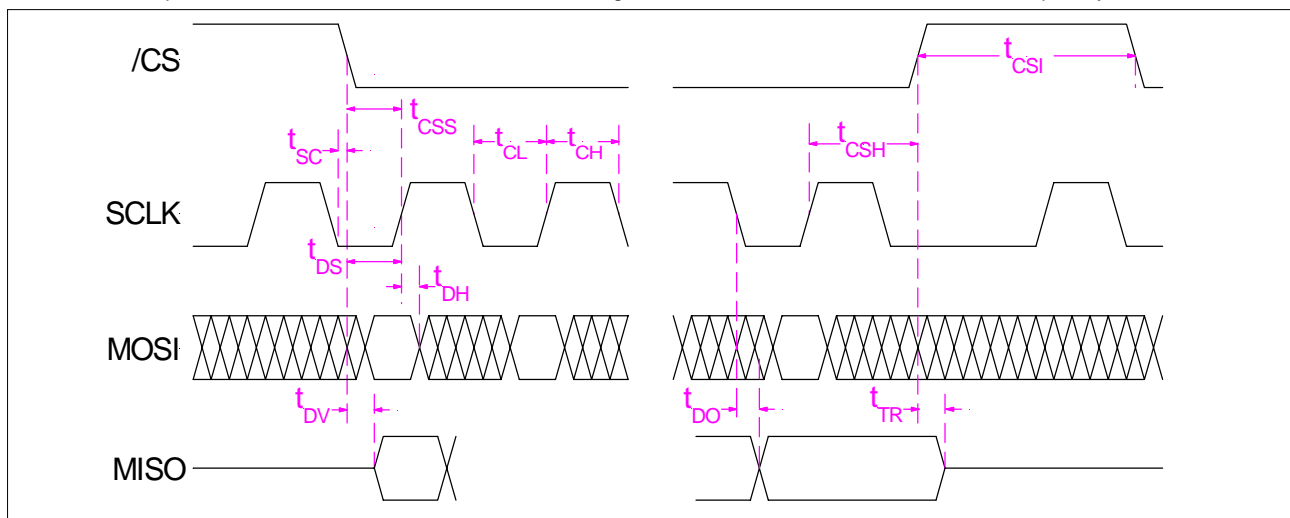

Fig. 5: Timing diagram

LDE Series

Digital low differential pressure sensors

OUTLINE DRAWING

LDE...E... (SMD, 2 ports same side)

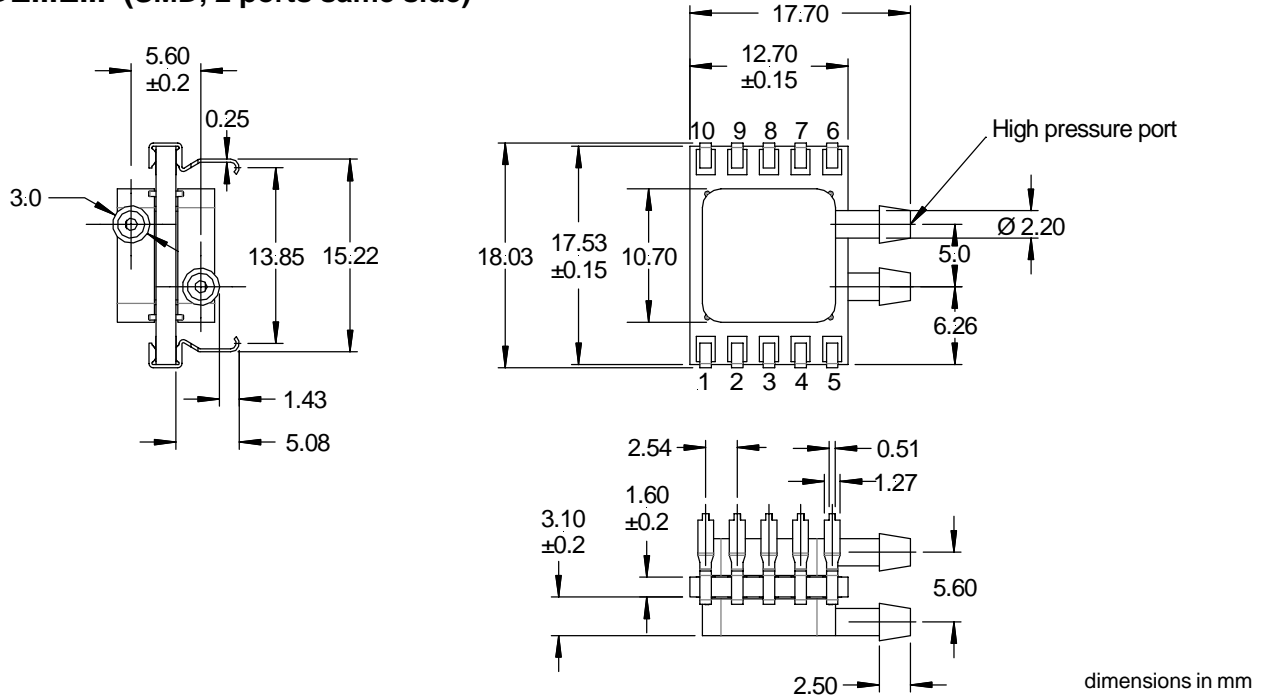

LDE...F... (DIP, 2 ports same side)

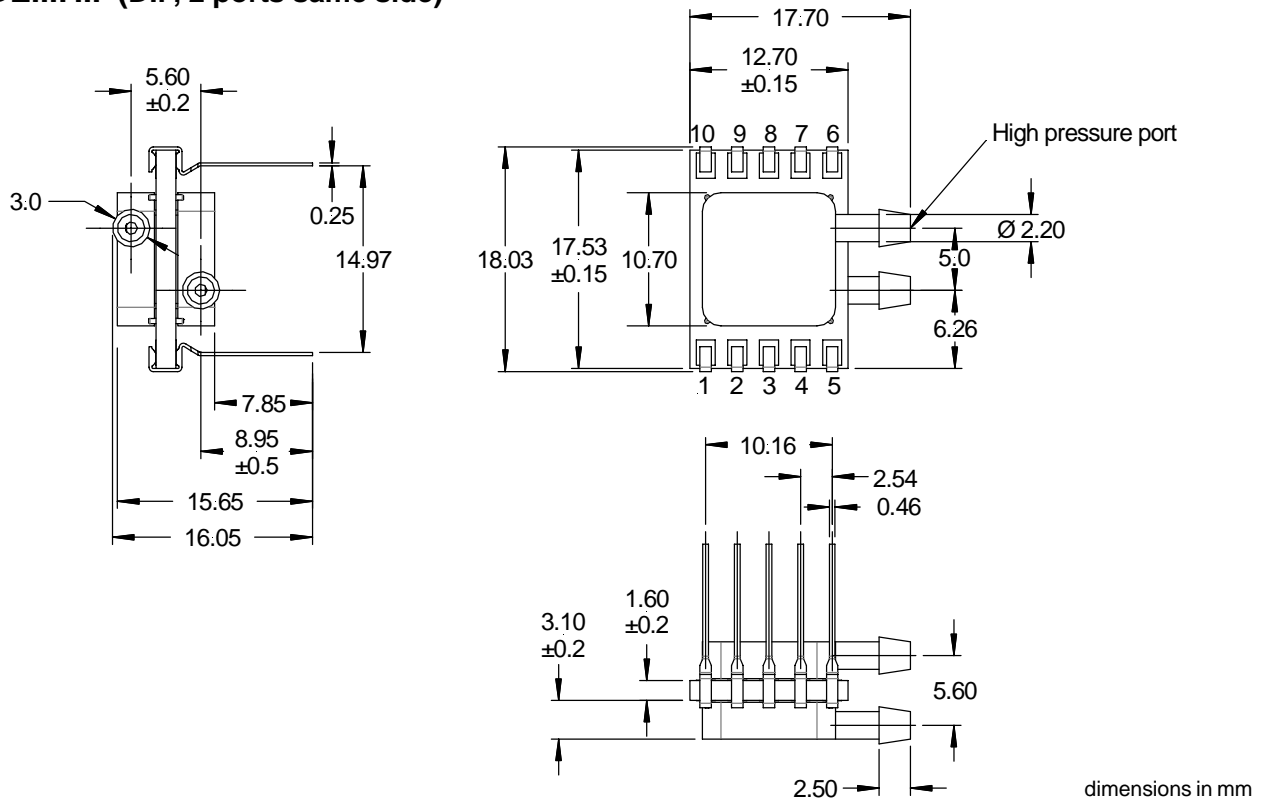

LDE Series

Digital low differential pressure sensors

ELECTRICAL CONNECTION (cont.)³

There are three use cases that will change the manner in which the LDE series device is connected in-circuit:

- Case 1: Reading of pressure measurement as a digital (SPI) signal;
- Case 2: Reading of pressure measurement as an analog (voltage) signal; and
- Case 3: Pin-to-pin compatible drop-in replacement for LBA series devices (5 V LDE devices only).

The connections for each such use case must be made as indicated below.

Pin	Function	Connection		
		Case 1: Digital signal output	Case 2: Analog signal output	Case 3: LBA drop-in replacement (5 V LDE only)
1	Reserved	NC	NC	GND
2	V _s	+5 V / +3 V	+5 V / +3 V	+5 V
3	GND	GND	GND	GND
4	Vout	NC	High-impedance analog input (e.g. op-amp, ADC)	High-impedance analog input (e.g. op-amp, ADC)
5	Vout	NC		
6	SCLK	Master device SCLK	GND	GND
7	MOSI	Master device MOSI	GND	GND
8	MISO	Master device MISO	GND	GND
9	/CS	Master device (/CS)	V _s	GND
10	Reserved	NC	NC	GND

ORDERING INFORMATION

Options	Series	Pressure range		Calibration		Housing		Output		Grade	
	LDE	S025	25 Pa (0.1 inH ₂ O)	B	Bidirectional	E	SMT, 2 ports same side	3	non-ratiometric, 3 V supply	S	High
		S050	50 Pa (0.2 inH ₂ O)	U	Unidirectional	F	DIP, 2 ports same side	6	non-ratiometric, 5 V supply		
		S100	100 Pa (0.4 inH ₂ O)								
		S250	250 Pa (1 inH ₂ O)								
		S500	500 Pa (2 inH ₂ O)								
Example:											
	LDE	S250		B		F		6		S	

First Sensor reserves the right to make changes to any products herein. First Sensor does not assume any liability arising out of the application or use of any product or circuit described herein, neither does it convey any license under its patent rights nor the rights of others.





Компания «ЭлектроПласт» предлагает заключение долгосрочных отношений при поставках импортных электронных компонентов на взаимовыгодных условиях!

Наши преимущества:

- Оперативные поставки широкого спектра электронных компонентов отечественного и импортного производства напрямую от производителей и с крупнейших мировых складов;
- Поставка более 17-ти миллионов наименований электронных компонентов;
- Поставка сложных, дефицитных, либо снятых с производства позиций;
- Оперативные сроки поставки под заказ (от 5 рабочих дней);
- Экспресс доставка в любую точку России;
- Техническая поддержка проекта, помощь в подборе аналогов, поставка прототипов;
- Система менеджмента качества сертифицирована по Международному стандарту ISO 9001;
- Лицензия ФСБ на осуществление работ с использованием сведений, составляющих государственную тайну;
- Поставка специализированных компонентов (Xilinx, Altera, Analog Devices, Intersil, Interpoint, Microsemi, Aeroflex, Peregrine, Syfer, Eurofarad, Texas Instrument, Miteq, Cobham, E2V, MA-COM, Hittite, Mini-Circuits, General Dynamics и др.);

Помимо этого, одним из направлений компании «ЭлектроПласт» является направление «Источники питания». Мы предлагаем Вам помощь Конструкторского отдела:

- Подбор оптимального решения, техническое обоснование при выборе компонента;
- Подбор аналогов;
- Консультации по применению компонента;
- Поставка образцов и прототипов;
- Техническая поддержка проекта;
- Защита от снятия компонента с производства.



Как с нами связаться

Телефон: 8 (812) 309 58 32 (многоканальный)

Факс: 8 (812) 320-02-42

Электронная почта: org@eplast1.ru

Адрес: 198099, г. Санкт-Петербург, ул. Калинина, дом 2, корпус 4, литера А.