

The S-T111 Series is a positive voltage regulator with a low dropout voltage, high-accuracy output voltage, and low current consumption developed based on CMOS technology.

A built-in low on-resistance transistor provides a low dropout voltage and large output current, and a built-in overcurrent protection circuit prevents the load current from exceeding the current capacity of the output transistor. An ON/OFF circuit ensures a long battery life. Compared with the voltage regulators using the conventional CMOS technology, a larger variety of capacitors are available, including small ceramic capacitors. A small SOT-23-5 package realizes high-density mounting.

■ Features

- Output voltage: 1.5 V to 5.5 V, selectable in 0.1 V step
- Output voltage accuracy: $\pm 1.0\%$
- Dropout voltage: 190 mV typ. (3.0 V output product, $I_{OUT} = 100$ mA)
- Current consumption: During operation: 50 μ A typ., 90 μ A max.
During power-off: 0.1 μ A typ., 1.0 μ A max.
- Output current: Possible to output 150 mA ($V_{IN} \geq V_{OUT(S)} + 1.0$ V)^{*1}
- Input and output capacitors: A ceramic capacitor of 0.1 μ F or more can be used.
- Ripple rejection: 80 dB typ. (f = 1.0 kHz)
- Built-in overcurrent protection circuit: Limits overcurrent of output transistor.
- Built-in ON/OFF circuit: Ensures long battery life.
- Operation temperature range: $T_a = -40^\circ\text{C}$ to $+85^\circ\text{C}$
- Lead-free, Sn 100%, halogen-free^{*2}

*1. Attention should be paid to the power dissipation of the package when the output current is large.

*2. Refer to “■ Product Name Structure” for details.

■ Applications

- Constant-voltage power supply for battery-powered device
- Constant-voltage power supply for personal communication device
- Constant-voltage power supply for home electric appliance
- Constant-voltage power supply for cellular phone

■ Package

- SOT-23-5

■ **Block Diagram**

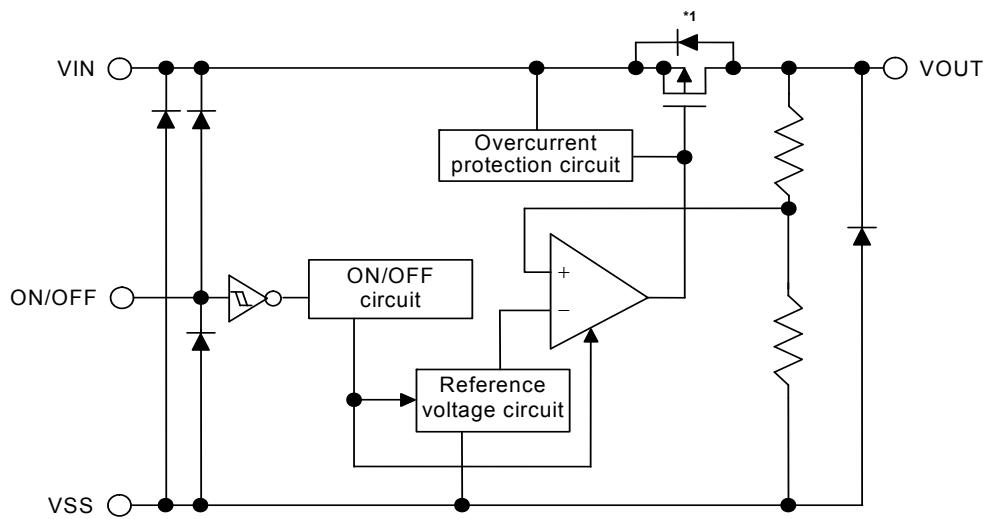

*1. Parasitic diode

Figure 1

■ Product Name Structure

- Users can select the product type, output voltage for the S-T111 Series. Refer to “1. Product name” regarding the contents of product name, “2. Package” regarding the package drawings, “3. Product name list” regarding details of the product name.

1. Product name

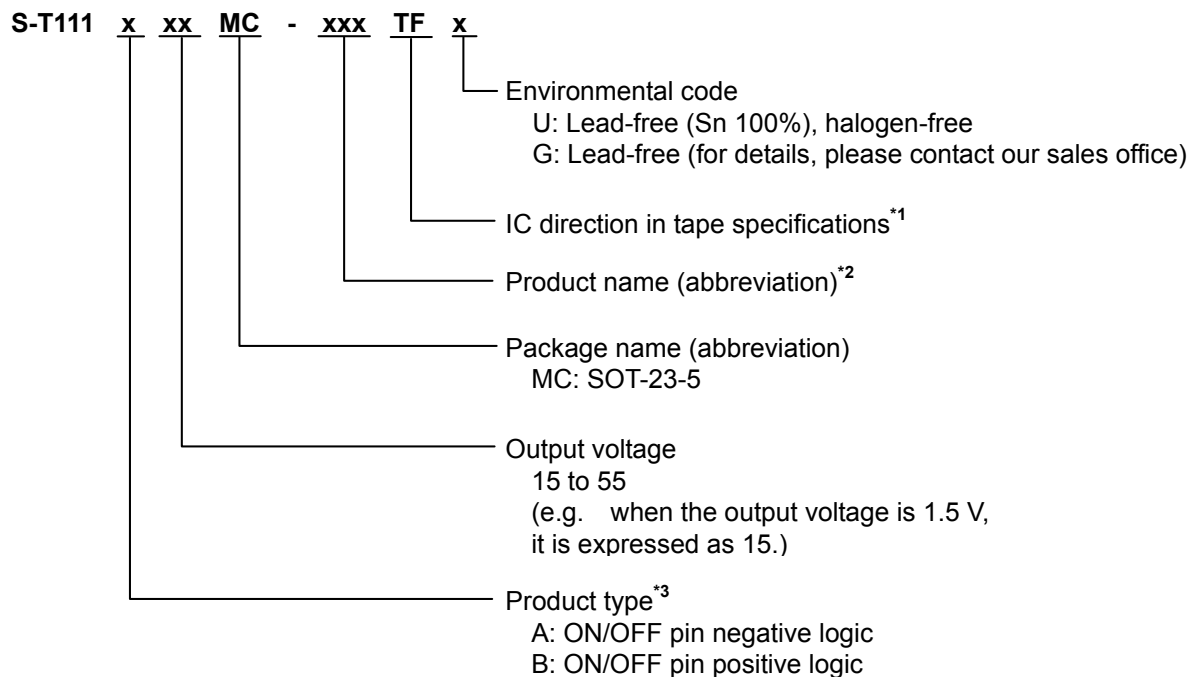

*1. Refer to the tape drawing.

*2. Refer to the product name list.

*3. Refer to “3. ON/OFF pin” in “■ Operation”.

2. Package

Package Name	Drawing Code		
	Package	Tape	Reel
SOT-23-5	MP005-A-P-SD	MP005-A-C-SD	MP005-A-R-SD

3. Product name list

Table 1

Output Voltage	Product Name
1.5V±1.0%	S-T111B15MC-OGATFx
1.6V±1.0%	S-T111B16MC-OGBTFx
1.7V±1.0%	S-T111B17MC-OGCTFx
1.8V±1.0%	S-T111B18MC-OGDTFx
1.9V±1.0%	S-T111B19MC-OGETFx
2.0V±1.0%	S-T111B20MC-OGFTFx
2.1V±1.0%	S-T111B21MC-OGGTFx
2.2V±1.0%	S-T111B22MC-OGHTFx
2.3V±1.0%	S-T111B23MC-OGITFx
2.4V±1.0%	S-T111B24MC-OGJTFx
2.5V±1.0%	S-T111B25MC-OGKTFx
2.6V±1.0%	S-T111B26MC-OGLTFx
2.7V±1.0%	S-T111B27MC-OGMTFx
2.8V±1.0%	S-T111B28MC-OGNTFx
2.9V±1.0%	S-T111B29MC-OGOTFx
3.0V±1.0%	S-T111B30MC-OGPTFx
3.1V±1.0%	S-T111B31MC-OGQTFx
3.2V±1.0%	S-T111B32MC-OGRTFx
3.3V±1.0%	S-T111B33MC-OGSTFx
3.4V±1.0%	S-T111B34MC-OGTTFx
3.5V±1.0%	S-T111B35MC-OGUTFx
3.6V±1.0%	S-T111B36MC-OGVTFx
3.7V±1.0%	S-T111B37MC-OGWTFx
3.8V±1.0%	S-T111B38MC-OGXTFx
3.9V±1.0%	S-T111B39MC-OGYTFx
4.0V±1.0%	S-T111B40MC-OGZTFx
4.1V±1.0%	S-T111B41MC-OHATFx
4.2V±1.0%	S-T111B42MC-OHBTFx
4.3V±1.0%	S-T111B43MC-OHCTFx
4.4V±1.0%	S-T111B44MC-OHDTFx
4.5V±1.0%	S-T111B45MC-OHETFx
4.6V±1.0%	S-T111B46MC-OHFTFx
4.7V±1.0%	S-T111B47MC-OHGTFx
4.8V±1.0%	S-T111B48MC-OHHTFx
4.9V±1.0%	S-T111B49MC-OHITFx
5.0V±1.0%	S-T111B50MC-OHJTFx
5.1V±1.0%	S-T111B51MC-OHKTFx
5.2V±1.0%	S-T111B52MC-OHLTFx
5.3V±1.0%	S-T111B53MC-OHMTFx
5.4V±1.0%	S-T111B54MC-OHNTFx
5.5V±1.0%	S-T111B55MC-OHOTFx

Remark 1. Please contact our sales office for products with type A.

2. x: G or U

3. Please select products of environmental code = U for Sn 100%, halogen-free products.

■ Pin Configuration

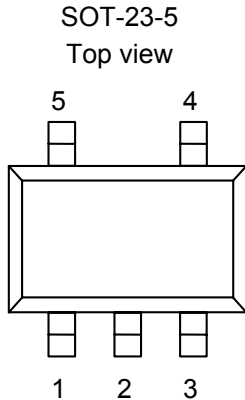

Figure 2

Table 2

Pin No.	Symbol	Description
1	ON/OFF	ON/OFF pin
2	VSS	GND pin
3	NC ^{*1}	No connection
4	VOUT	Output voltage pin
5	VIN	Input voltage pin

*1. The NC pin is electrically open.
The NC pin can be connected to VIN pin or VSS pin.

■ Absolute Maximum Ratings

Table 3

(Ta = 25°C unless otherwise specified)

Item	Symbol	Absolute Maximum Rating	Unit
Input voltage	V _{IN}	V _{SS} - 0.3 to V _{SS} + 7	V
	V _{ON/OFF}	V _{SS} - 0.3 to V _{IN} + 0.3	V
Output voltage	V _{OUT}	V _{SS} - 0.3 to V _{IN} + 0.3	V
Power dissipation	P _D	300 (When not mounted on board)	mW
		600 ^{*1}	mW
Operation ambient temperature	T _{opr}	-40 to +85	°C
Storage temperature	T _{stg}	-40 to +125	°C

- *1. When mounted on board
[Mounted board]
(1) Board size : 114.3 mm × 76.2 mm × t1.6 mm
(2) Board name : JEDEC STANDARD51-7

Caution The absolute maximum ratings are rated values exceeding which the product could suffer physical damage. These values must therefore not be exceeded under any conditions.

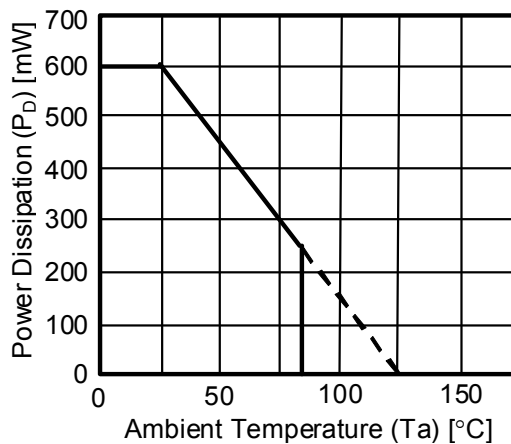

Figure 3 Power Dissipation of Package (When Mounted on Board)

■ **Electrical Characteristics**

Table 4

(Ta = 25°C unless otherwise specified)

Item	Symbol	Condition	Min.	Typ.	Max.	Unit	Test Circuit			
Output voltage*1	V _{OUT(E)}	V _{IN} = V _{OUT(S)} + 1.0 V, I _{OUT} = 30 mA	V _{OUT(S)} × 0.99	V _{OUT(S)}	V _{OUT(S)} × 1.01	V	1			
Output current*2	I _{OUT}	V _{IN} ≥ V _{OUT(S)} + 1.0 V	150*5	—	—	mA	3			
Dropout voltage*3	V _{drop}	I _{OUT} = 50 mA	1.5 V ≤ V _{OUT(S)} ≤ 2.7 V			Not specified		V	1	
			2.8 V ≤ V _{OUT(S)} ≤ 5.5 V			—	0.08	0.14	V	1
		I _{OUT} = 100 mA	1.5 V ≤ V _{OUT(S)} ≤ 1.6 V			—	0.32	0.55	V	1
			1.7 V ≤ V _{OUT(S)} ≤ 1.8 V			—	0.28	0.47	V	1
			1.9 V ≤ V _{OUT(S)} ≤ 2.3 V			—	0.25	0.35	V	1
			2.4 V ≤ V _{OUT(S)} ≤ 2.7 V			—	0.20	0.29	V	1
2.8 V ≤ V _{OUT(S)} ≤ 5.5 V			—	0.19	0.26	V	1			
Line regulation	$\frac{\Delta V_{OUT1}}{\Delta V_{IN} \cdot V_{OUT}}$	V _{OUT(S)} + 0.5 V ≤ V _{IN} ≤ 6.5 V, I _{OUT} = 30 mA	—	0.05	0.2	%/V	1			
Load regulation	ΔV _{OUT2}	V _{IN} = V _{OUT(S)} + 1.0 V, 1.0 mA ≤ I _{OUT} ≤ 80 mA	—	12	40	mV	1			
Output voltage temperature coefficient*4	$\frac{\Delta V_{OUT}}{\Delta T_a \cdot V_{OUT}}$	V _{IN} = V _{OUT(S)} + 1.0 V, I _{OUT} = 10 mA, −40°C ≤ Ta ≤ 85°C	—	±100	—	ppm/°C	1			
Current consumption during operation	I _{SS1}	V _{IN} = V _{OUT(S)} + 1.0 V, ON/OFF pin = ON, no load	—	50	90	μA	2			
Current consumption during power-off	I _{SS2}	V _{IN} = V _{OUT(S)} + 1.0 V, ON/OFF pin = OFF, no load	—	0.1	1.0	μA	2			
Input voltage	V _{IN}	—	2.0	—	6.5	V	—			
ON/OFF pin input voltage "H"	V _{SH}	V _{IN} = V _{OUT(S)} + 1.0 V, R _L = 1.0 kΩ	1.5	—	—	V	4			
ON/OFF pin input voltage "L"	V _{SL}	V _{IN} = V _{OUT(S)} + 1.0 V, R _L = 1.0 kΩ	—	—	0.3	V	4			
ON/OFF pin input current "H"	I _{SH}	V _{IN} = 6.5 V, V _{ON/OFF} = 6.5 V	−0.1	—	0.1	μA	4			
ON/OFF pin input current "L"	I _{SL}	V _{IN} = 6.5 V, V _{ON/OFF} = 0 V	−0.1	—	0.1	μA	4			
Ripple rejection	RR	V _{IN} = V _{OUT(S)} + 1.0 V, f = 1.0 kHz, ΔV _{rip} = 0.5 V _{rms} , I _{OUT} = 30 mA	—	80	—	dB	5			
Short-circuit current	I _{short}	V _{IN} = V _{OUT(S)} + 1.0 V, ON/OFF pin = ON, V _{OUT} = 0 V	—	200	—	mA	3			

*1. V_{OUT(S)}: Set output voltage

V_{OUT(E)}: Actual output voltage

Output voltage when fixing I_{OUT} (= 30 mA) and inputting V_{OUT(S)} + 1.0 V

*2. The output current at which the output voltage becomes 95% of V_{OUT(E)} after gradually increasing the output current.

*3. V_{drop} = V_{IN1} − (V_{OUT3} × 0.98)

V_{OUT3} is the output voltage when V_{IN} = V_{OUT(S)} + 1.0 V and I_{OUT} = 50 mA or I_{OUT} = 100 mA.

V_{IN1} is the input voltage at which the output voltage becomes 98% of V_{OUT3} after gradually decreasing the input voltage.

*4. A change in the temperature of the output voltage [mV/°C] is calculated using the following equation.

$$\frac{\Delta V_{OUT}}{\Delta T_a} [\text{mV}/^\circ\text{C}]^{*1} = V_{OUT(S)} [\text{V}]^{*2} \times \frac{\Delta V_{OUT}}{\Delta T_a \cdot V_{OUT}} [\text{ppm}/^\circ\text{C}]^{*3} \div 1000$$

*1. Change in temperature of output voltage

*2. Set output voltage

*3. Output voltage temperature coefficient

*5. The output current can be at least this value.

Due to restrictions on the package power dissipation, this value may not be satisfied. Attention should be paid to the power dissipation of the package when the output current is large.

This specification is guaranteed by design.

■ Test Circuits

1.

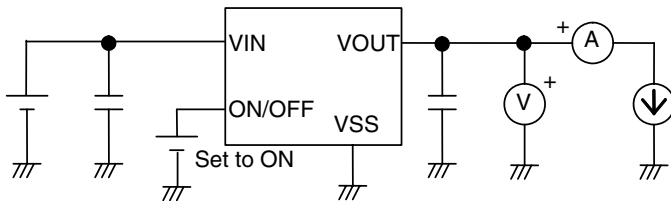

Figure 4

2.

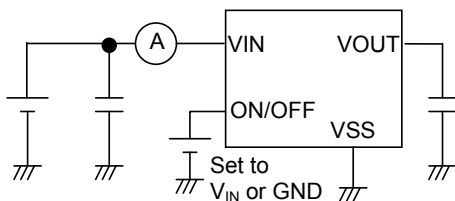

Figure 5

3.

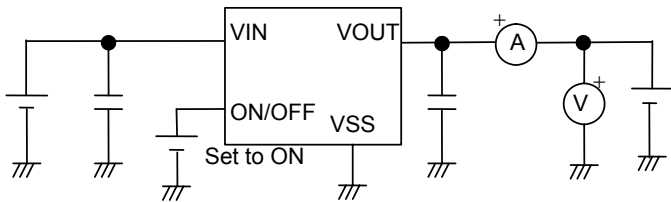

Figure 6

4.

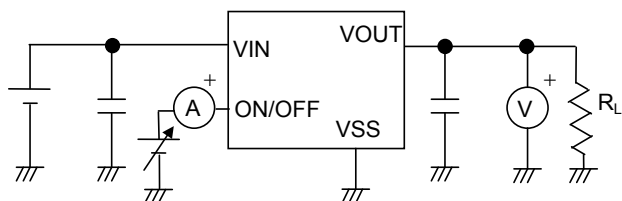

Figure 7

5.

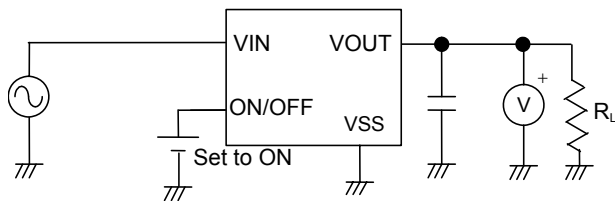
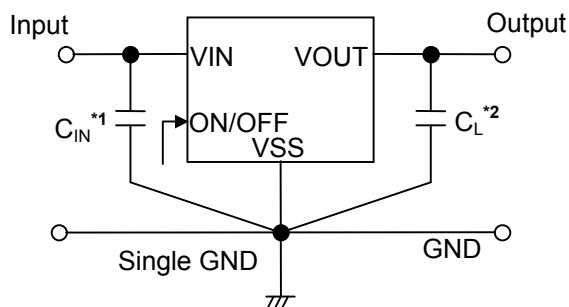

Figure 8

■ **Standard Circuit**



*1. C_{IN} is a capacitor for stabilizing the input.

*2. A ceramic capacitor of 0.1 μF or more can be used for C_L .

Figure 9

Caution The above connection diagram and constant will not guarantee successful operation. Perform thorough evaluation using the actual application to set the constant.

■ **Condition of Application**

Input capacitor (C_{IN}):	0.1 μF or more
Output capacitor (C_L):	0.1 μF or more
ESR of output capacitor:	10 Ω or less

Caution Generally a series regulator may cause oscillation, depending on the selection of external parts. Check that no oscillation occurs with the application using the above capacitor.

■ **Selection of Input and Output Capacitors (C_{IN} , C_L)**

The S-T111 Series requires an output capacitor between the VOUT pin and the VSS pin for phase compensation. Operation is stabilized by a ceramic capacitor with an output capacitance of 0.1 μF or more in the entire temperature range. When using an OS capacitor, a tantalum capacitor, or an aluminum electrolytic capacitor, the capacitance must be 0.1 μF or more, and the ESR must be 10 Ω or less.

The value of the output overshoot or undershoot transient response varies depending on the value of the output capacitor. The required capacitance of the input capacitor differs depending on the application.

The recommended value for an application is $C_{IN} \geq 1.0 \mu\text{F}$ and $C_L \geq 0.47 \mu\text{F}$; however, when selecting the output capacitor, perform sufficient evaluation, including evaluation of temperature characteristics, on the actual device.

■ Explanation of Terms

1. Low dropout voltage regulator

This voltage regulator has the low dropout voltage due to its built-in low on-resistance transistor.

2. Low ESR

A capacitor whose ESR (Equivalent Series Resistance) is low. The S-T111 Series enables use of a low ESR capacitor, such as a ceramic capacitor, for the output-side capacitor (C_L). A capacitor whose ESR is $10\ \Omega$ or less can be used.

3. Output voltage (V_{OUT})

The accuracy of the output voltage is ensured at $\pm 1.0\%$ under the specified conditions of fixed input voltage^{*1}, fixed output current, and fixed temperature.

*1. Differs depending on the product.

Caution If the above conditions change, the output voltage value may vary and exceed the accuracy range of the output voltage. Refer to “■ Electrical Characteristics” and “■ Characteristics (Typical Data)” for details.

4. Line Regulation $\left(\frac{\Delta V_{OUT1}}{\Delta V_{IN} \cdot V_{OUT}}\right)$

Indicates the dependency of the output voltage on the input voltage. That is, the values show how much the output voltage changes due to a change in the input voltage with the output current remaining unchanged.

5. Load regulation (ΔV_{OUT2})

Indicates the dependency of the output voltage on the output current. That is, the values show how much the output voltage changes due to a change in the output current with the input voltage remaining unchanged.

6. Dropout voltage (V_{drop})

Indicates the difference between input voltage (V_{IN1}) and the output voltage when; decreasing input voltage (V_{IN}) gradually until the output voltage has dropped out to the value of 98% of output voltage (V_{OUT3}), which is at $V_{IN} = (V_{OUT3} \times 0.98)$.

$$V_{drop} = V_{IN1} - (V_{OUT3} \times 0.98)$$

7. Output Voltage Temperature Coefficient $\left(\frac{\Delta V_{OUT}}{\Delta T_a \bullet V_{OUT}} \right)$

The shaded area in **Figure 10** is the range where V_{OUT} varies in the operation temperature range when the output voltage temperature coefficient is ± 100 ppm/ $^{\circ}\text{C}$.

Example of S-T111B28 typ. product

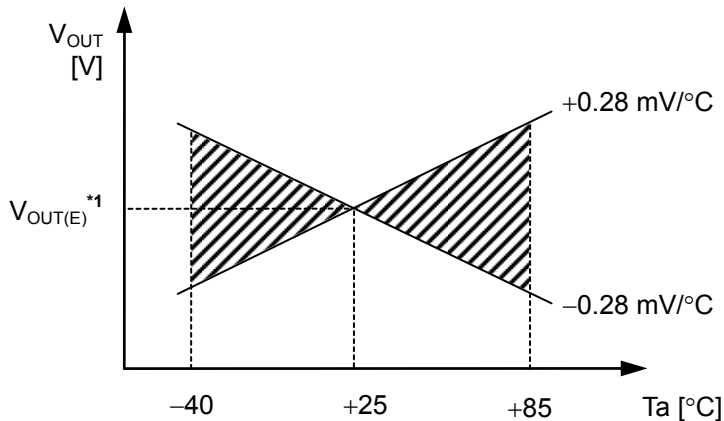

*1. $V_{OUT(E)}$ is the value of the output voltage measured at $T_a = +25^{\circ}\text{C}$.

Figure 10

A change in the temperature of the output voltage [mV/ $^{\circ}\text{C}$] is calculated using the following equation.

$$\frac{\Delta V_{OUT}}{\Delta T_a} \text{ [mV/}^{\circ}\text{C]}^{*1} = V_{OUT(S)} \text{ [V]}^{*2} \times \frac{\Delta V_{OUT}}{\Delta T_a \bullet V_{OUT}} \text{ [ppm/}^{\circ}\text{C]}^{*3} \div 1000$$

- *1. Change in temperature of output voltage
- *2. Set output voltage
- *3. Output voltage temperature coefficient

■ Operation

1. Basic operation

Figure 11 shows the block diagram of the S-T111 Series.

The error amplifier compares the reference voltage (V_{ref}) with feedback voltage (V_{fb}), which is the output voltage resistance-divided by feedback resistors (R_s and R_f). It supplies the gate voltage necessary to maintain the constant output voltage which is not influenced by the input voltage and temperature change, to the output transistor.

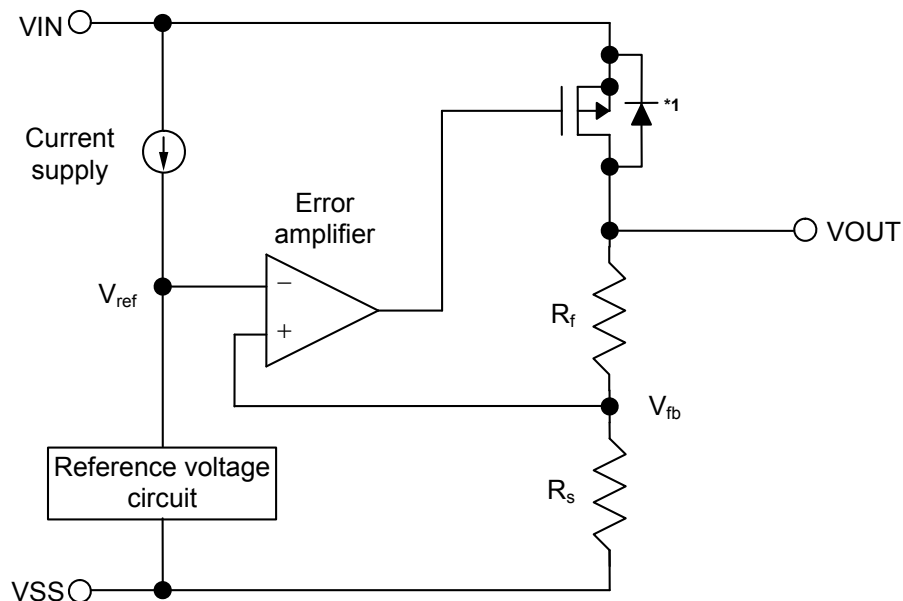

*1. Parasitic diode

Figure 11

2. Output transistor

In the S-T111 Series, a low on-resistance P-channel MOS FET is used as the output transistor.

Be sure that V_{OUT} does not exceed $V_{IN} + 0.3$ V to prevent the voltage regulator from being damaged due to reverse current flowing from the V_{OUT} pin through a parasitic diode to the V_{IN} pin, when the potential of V_{OUT} became higher than V_{IN} .

3. ON/OFF pin

This pin starts and stops the regulator.

When the ON/OFF pin is set to OFF level, the entire internal circuit stops operating, and the built-in P-channel MOS FET output transistor between the VIN pin and the VOUT pin is turned off, reducing current consumption significantly. The VOUT pin becomes the V_{SS} level due to the internally divided resistance of several MΩ between the VOUT pin and the VSS pin.

The structure of the ON/OFF pin is as shown in **Figure 12**. Since the ON/OFF pin is neither pulled down nor pulled up internally, do not use it in the floating status. In addition, note that the current consumption increases if a voltage of 0.3 V to V_{IN} – 0.3 V is applied to the ON/OFF pin. When not using the ON/OFF pin, connect it to the VSS pin in the product A type, and connect it to the VIN pin in B type.

Table 5

Product Type	ON/OFF Pin	Internal Circuit	VOUT Pin Voltage	Current Consumption
A	“L”: ON	Operate	Set value	I _{SS1}
A	“H”: OFF	Stop	V _{SS} level	I _{SS2}
B	“L”: OFF	Stop	V _{SS} level	I _{SS2}
B	“H”: ON	Operate	Set value	I _{SS1}

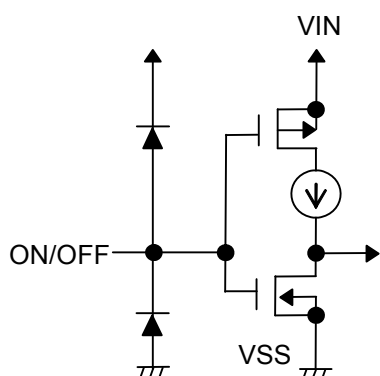

Figure 12

■ Precautions

- Wiring patterns for the VIN pin, the VOUT pin and GND should be designed so that the impedance is low. When mounting an output capacitor between the VOUT pin and the VSS pin (C_L) and a capacitor for stabilizing the input between the VIN pin and the VSS pin (C_{IN}), the distance from the capacitors to these pins should be as short as possible.
- Note that generally the output voltage may increase when a series regulator is used at low load current (1.0 mA or less).
- Generally a series regulator may cause oscillation, depending on the selection of external parts. The following conditions are recommended for S-T111 Series. However, be sure to perform sufficient evaluation under the actual usage conditions for selection, including evaluation of temperature characteristics.

Input capacitor (C_{IN}):	1.0 μ F or more
Output capacitor (C_L):	0.47 μ F or more
Equivalent series resistance (ESR):	10 Ω or less

- The voltage regulator may oscillate when the impedance of the power supply is high and the input capacitance is small or an input capacitor is not connected.
- Overshoot may occur in the output voltage momentarily if the voltage is rapidly raised at power-on or when the power supply fluctuates. Sufficiently evaluate the output voltage at power-on with the actual device.
- The application conditions for the input voltage, the output voltage, and the load current should not exceed the package power dissipation.
- Do not apply an electrostatic discharge to this IC that exceeds the performance ratings of the built-in electrostatic protection circuit.
- In determining the output current, attention should be paid to the output current value specified in **Table 4** in “■ **Electrical Characteristics**” and footnote *5 of the table.
- ABLIC Inc. claims no responsibility for any disputes arising out of or in connection with any infringement by products including this IC of patents owned by a third party.

■ Characteristics (Typical Data)

(1) Output Voltage vs. Output current (when load current increases)

S-T111B15 (Ta = 25°C)

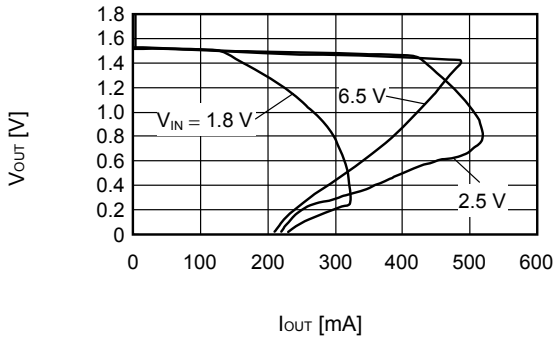

S-T111B30 (Ta = 25°C)

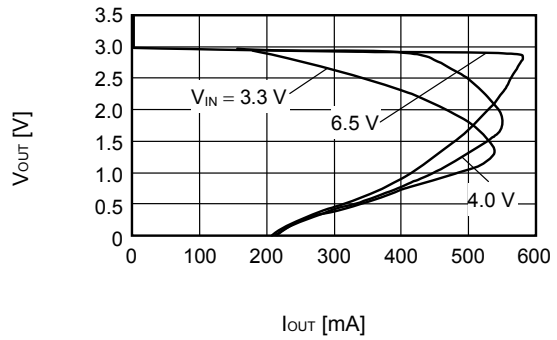

S-T111B50 (Ta = 25°C)

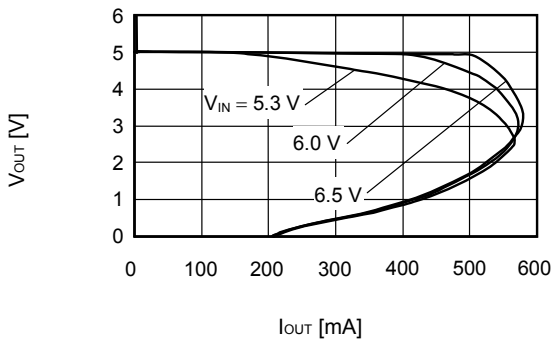

Remark In determining the output current, attention should be paid to the following.

- 1) The minimum output current value and footnote *5 in the “**■ Electrical Characteristics**”
- 2) The package power dissipation

(2) Output voltage vs. Input voltage

S-T111B15 (Ta = 25°C)

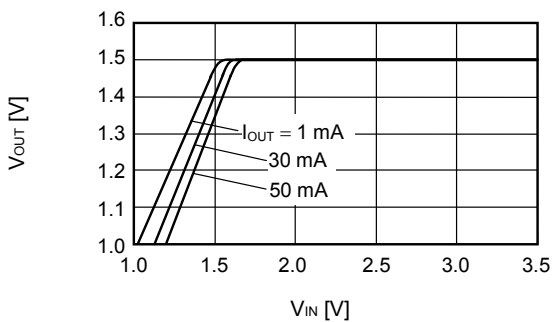

S-T111B30 (Ta = 25°C)

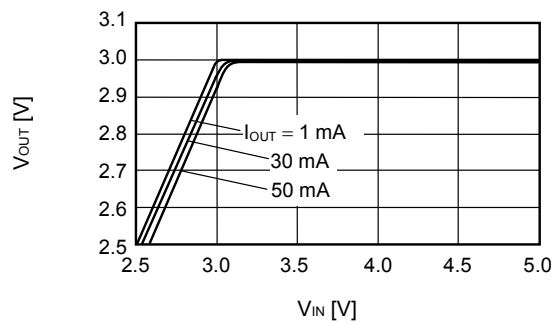

S-T111B50 (Ta = 25°C)

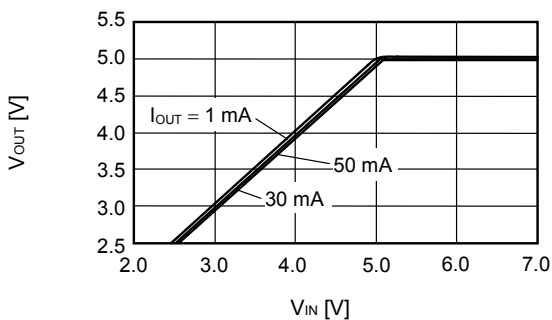

(3) Dropout voltage vs. Output current

S-T111B15

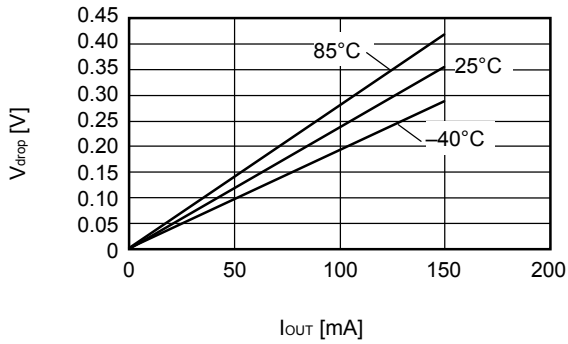

S-T111B30

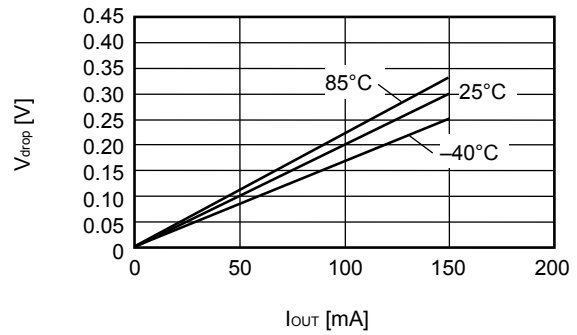

S-T111B50

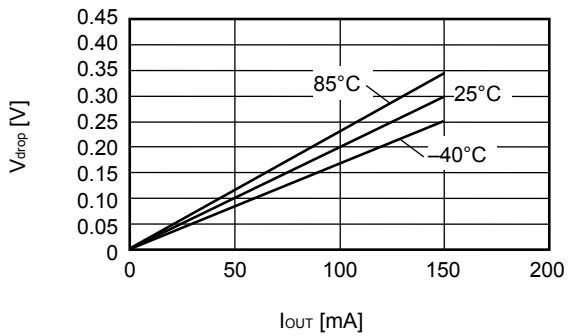

(4) Dropout voltage vs. Set output voltage

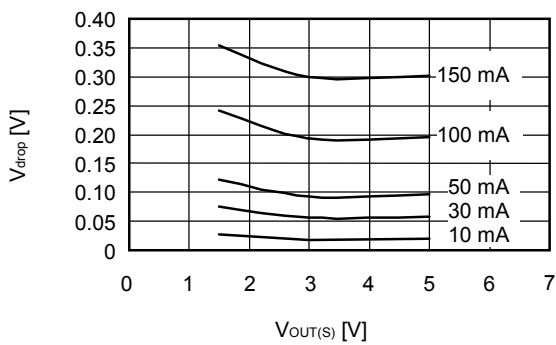

(5) Output voltage vs. Ambient temperature

S-T111B15

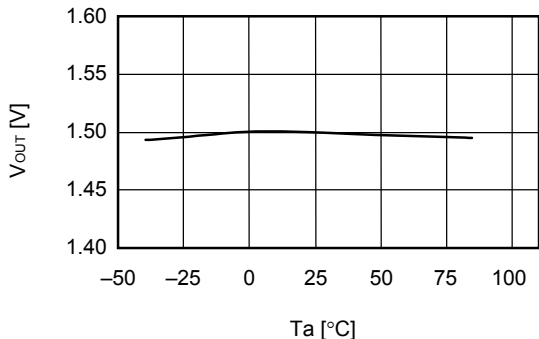

S-T111B30

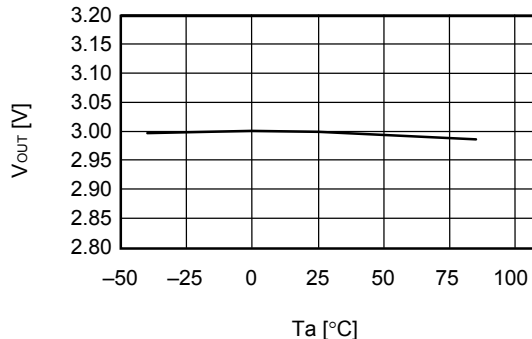

S-T111B50

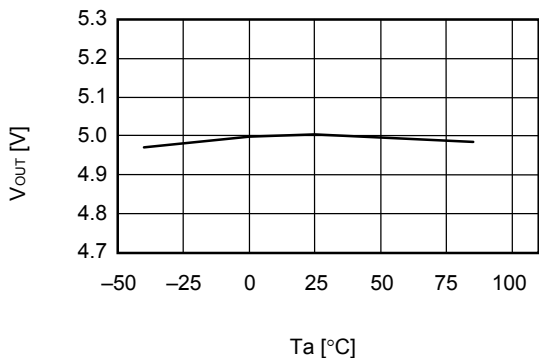

(6) Current consumption vs. Input voltage

S-T111B15

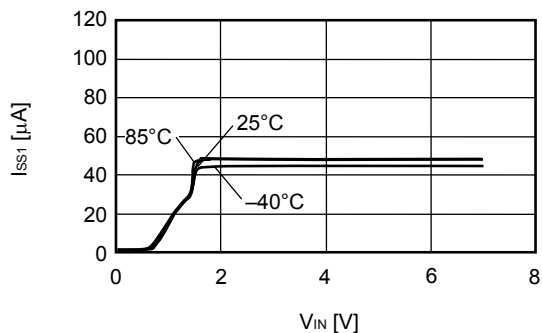

S-T111B30

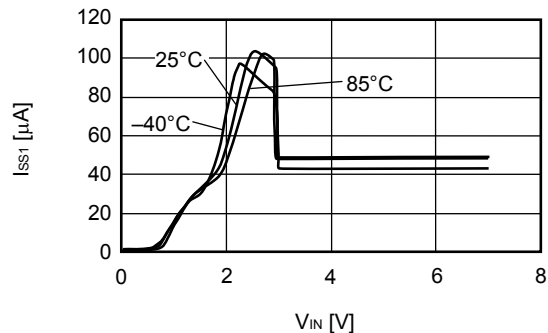

S-T111B50

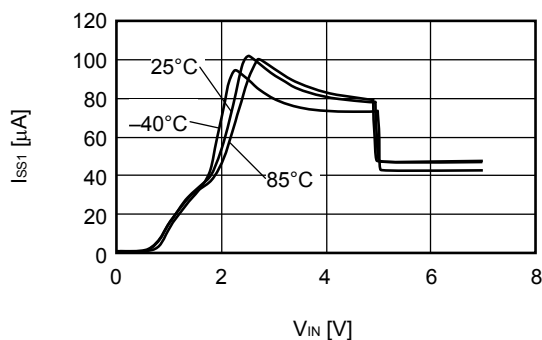

(7) Ripple rejection

S-T111B15 ($T_a = 25^\circ\text{C}$)

$V_{IN} = 2.5\text{ V}$, $C_{OUT} = 0.47\ \mu\text{F}$

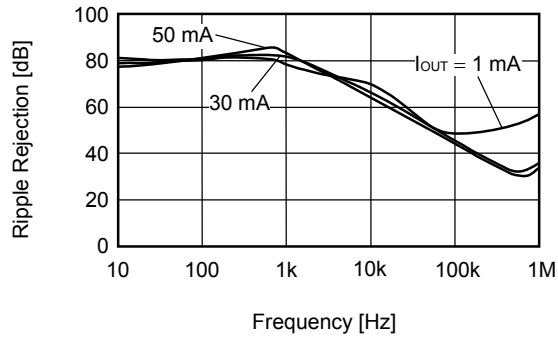

S-T111B30 ($T_a = 25^\circ\text{C}$)

$V_{IN} = 4.0\text{ V}$, $C_{OUT} = 0.47\ \mu\text{F}$

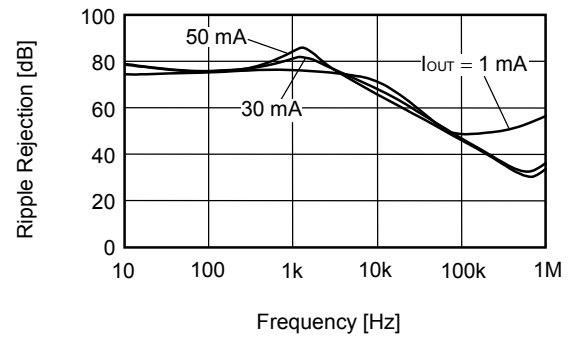

S-T111B50 ($T_a = 25^\circ\text{C}$)

$V_{IN} = 6.0\text{ V}$, $C_{OUT} = 0.47\ \mu\text{F}$

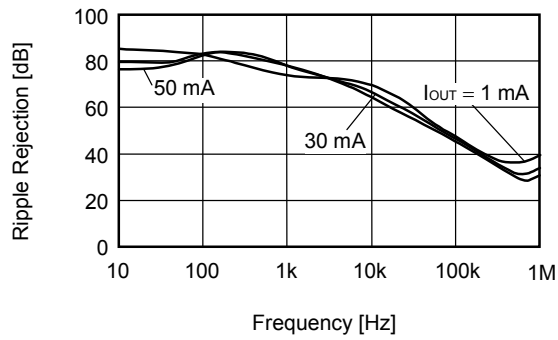

■ **Reference Data**

(1) Input transient response characteristics

S-T111B15 (Ta = 25°C)

I_{OUT} = 30 mA, t_r = t_f = 5.0 μs, C_{OUT} = 0.47 μF, C_{IN} = 0 μF

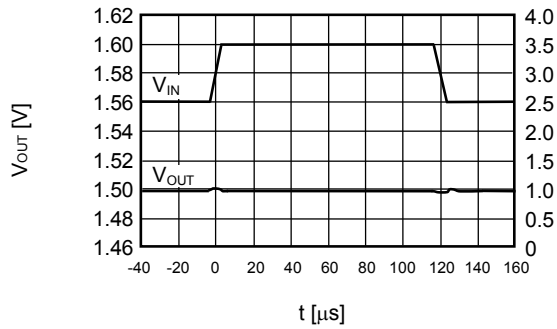

S-T111B30 (Ta = 25°C)

I_{OUT} = 30 mA, t_r = t_f = 5.0 μs, C_{OUT} = 0.47 μF, C_{IN} = 0 μF

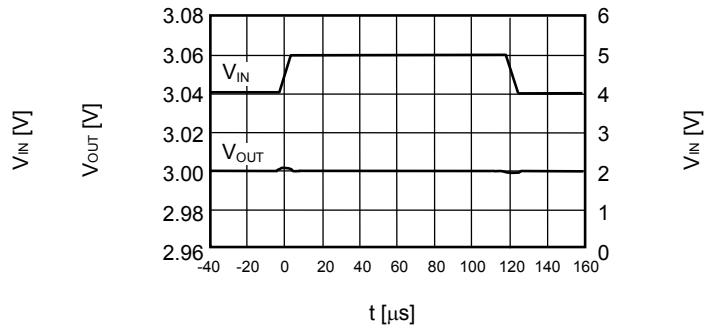

S-T111B50 (Ta = 25°C)

I_{OUT} = 30 mA, t_r = t_f = 5.0 μs, C_{OUT} = 0.47 μF, C_{IN} = 0 μF

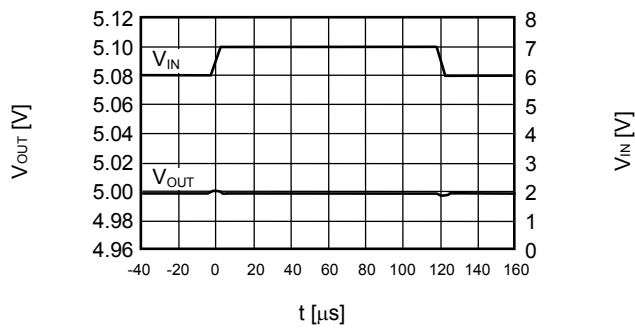

(2) Load transient response characteristics

S-T111B15 (Ta = 25°C)

V_{IN} = 2.5 V, C_{OUT} = 0.47 μF, C_{IN} = 1.0 μF, I_{OUT} = 50 mA ↔ 100 mA

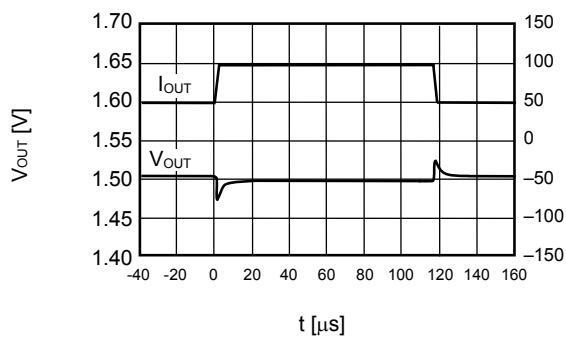

S-T111B30 (Ta = 25°C)

V_{IN} = 4.0 V, C_{OUT} = 0.47 μF, C_{IN} = 1.0 μF, I_{OUT} = 50 mA ↔ 100 mA

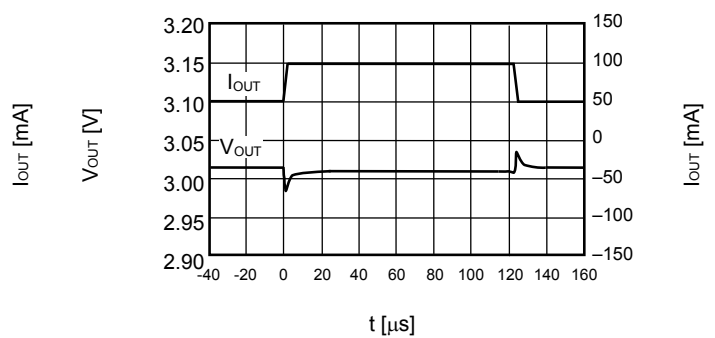

S-T111B50 (Ta = 25°C)

V_{IN} = 6.0 V, C_{OUT} = 0.47 μF, C_{IN} = 1.0 μF, I_{OUT} = 50 mA ↔ 100 mA

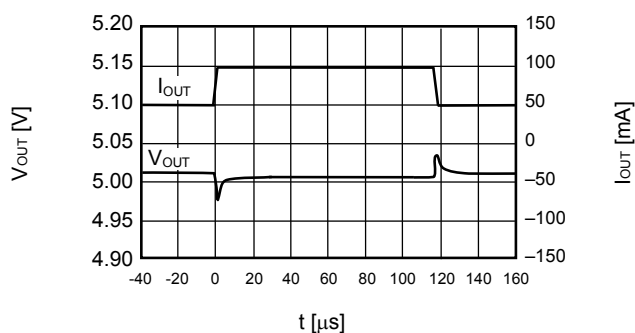

(3) ON/OFF pin transient response characteristics

S-T111B15 (Ta = 25°C)

V_{IN} = 2.5 V, C_{OUT} = 0.47 μF, C_{IN} = 1.0 μF, I_{OUT} = 100 mA

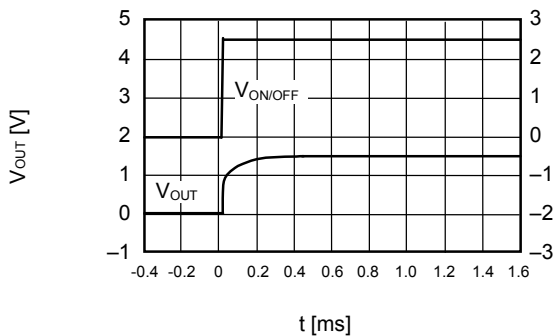

S-T111B30 (Ta = 25°C)

V_{IN} = 4.0 V, C_{OUT} = 0.47 μF, C_{IN} = 1.0 μF, I_{OUT} = 100 mA

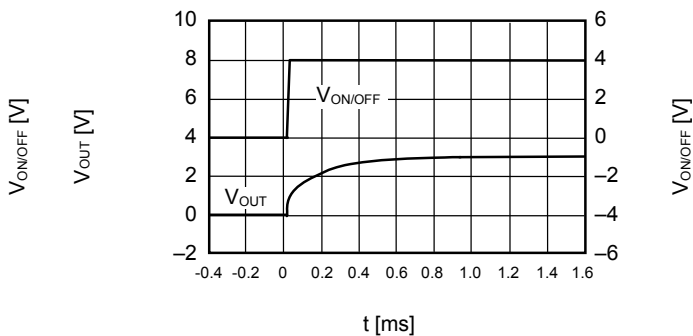

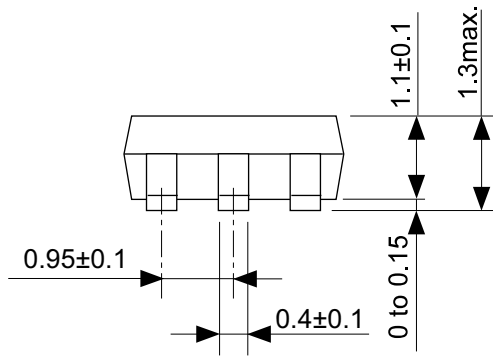
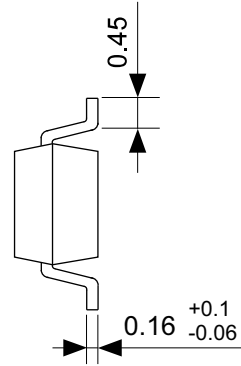
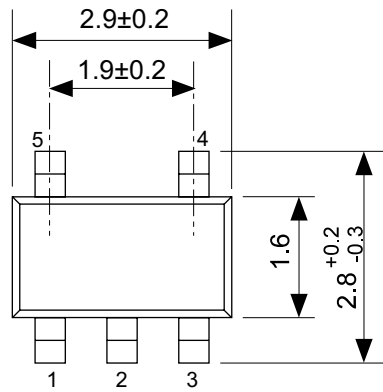

No. MP005-A-P-SD-1.3

TITLE	SOT235-A-PKG Dimensions
No.	MP005-A-P-SD-1.3
ANGLE	
UNIT	mm
ABLIC Inc.	

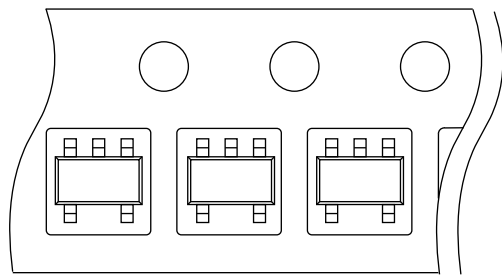
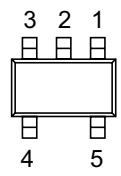
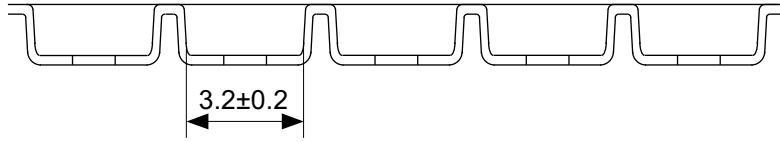
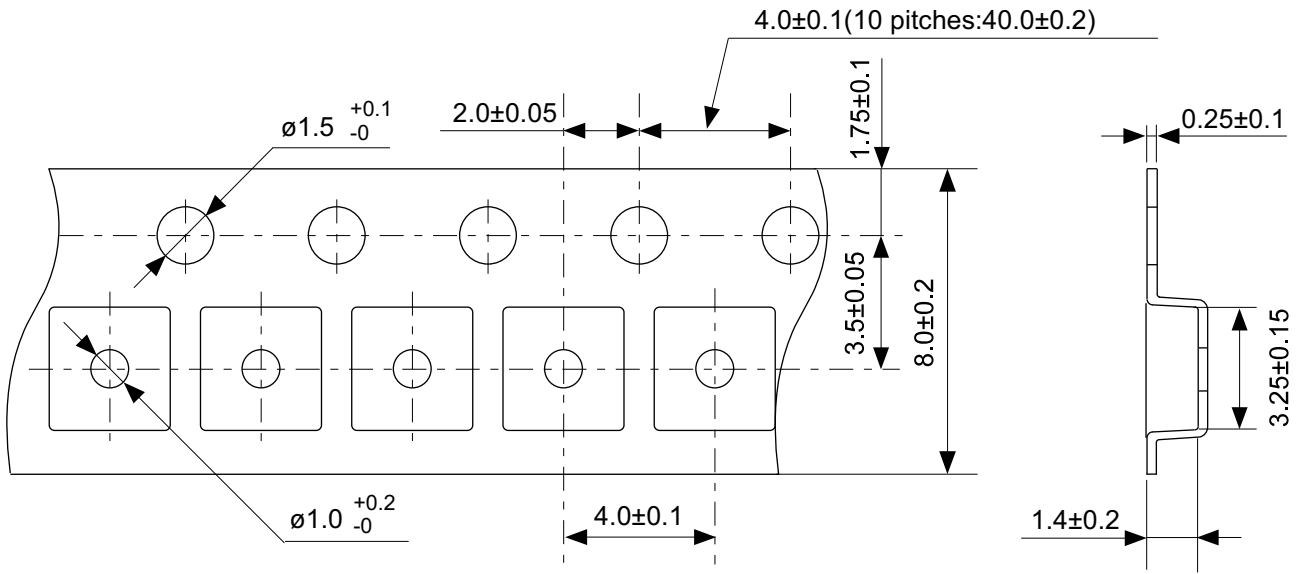

→ Feed direction

No. MP005-A-C-SD-2.1

TITLE	SOT235-A-Carrier Tape
No.	MP005-A-C-SD-2.1
ANGLE	
UNIT	mm

ABLIC Inc.

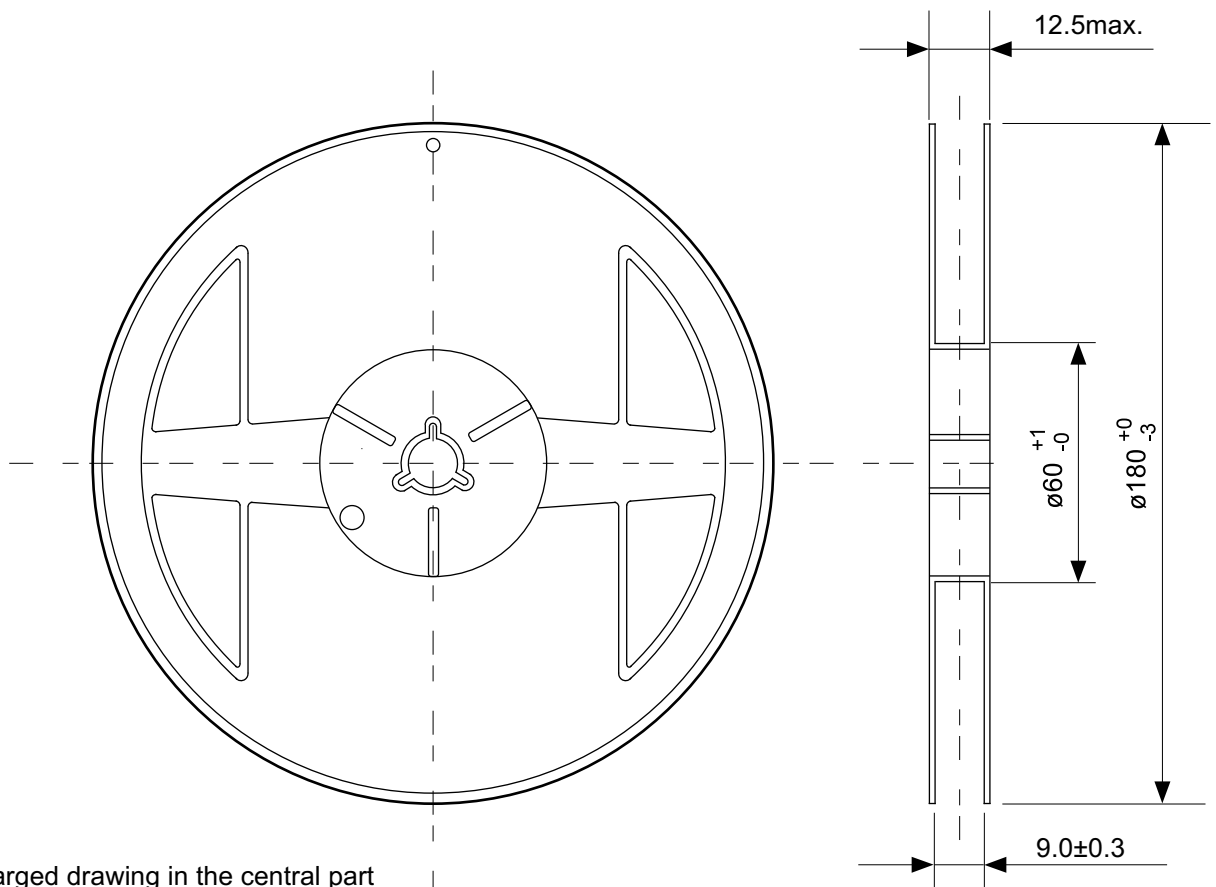

Enlarged drawing in the central part

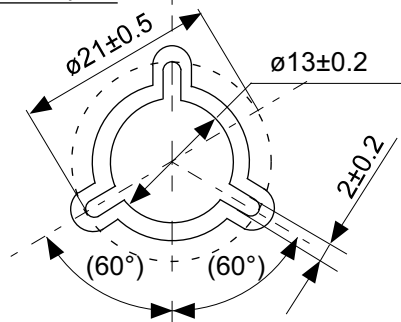

No. MP005-A-R-SD-1.1

TITLE	SOT235-A-Reel		
No.	MP005-A-R-SD-1.1		
ANGLE		QTY.	3,000
UNIT	mm		
ABLIC Inc.			

Disclaimers (Handling Precautions)

1. All the information described herein (product data, specifications, figures, tables, programs, algorithms and application circuit examples, etc.) is current as of publishing date of this document and is subject to change without notice.
2. The circuit examples and the usages described herein are for reference only, and do not guarantee the success of any specific mass-production design.
ABLIC Inc. is not liable for any losses, damages, claims or demands caused by the reasons other than the products described herein (hereinafter "the products") or infringement of third-party intellectual property right and any other right due to the use of the information described herein.
3. ABLIC Inc. is not liable for any losses, damages, claims or demands caused by the incorrect information described herein.
4. Be careful to use the products within their ranges described herein. Pay special attention for use to the absolute maximum ratings, operation voltage range and electrical characteristics, etc.
ABLIC Inc. is not liable for any losses, damages, claims or demands caused by failures and / or accidents, etc. due to the use of the products outside their specified ranges.
5. Before using the products, confirm their applications, and the laws and regulations of the region or country where they are used and verify suitability, safety and other factors for the intended use.
6. When exporting the products, comply with the Foreign Exchange and Foreign Trade Act and all other export-related laws, and follow the required procedures.
7. The products are strictly prohibited from using, providing or exporting for the purposes of the development of weapons of mass destruction or military use. ABLIC Inc. is not liable for any losses, damages, claims or demands caused by any provision or export to the person or entity who intends to develop, manufacture, use or store nuclear, biological or chemical weapons or missiles, or use any other military purposes.
8. The products are not designed to be used as part of any device or equipment that may affect the human body, human life, or assets (such as medical equipment, disaster prevention systems, security systems, combustion control systems, infrastructure control systems, vehicle equipment, traffic systems, in-vehicle equipment, aviation equipment, aerospace equipment, and nuclear-related equipment), excluding when specified for in-vehicle use or other uses by ABLIC, Inc. Do not apply the products to the above listed devices and equipments.
ABLIC Inc. is not liable for any losses, damages, claims or demands caused by unauthorized or unspecified use of the products.
9. In general, semiconductor products may fail or malfunction with some probability. The user of the products should therefore take responsibility to give thorough consideration to safety design including redundancy, fire spread prevention measures, and malfunction prevention to prevent accidents causing injury or death, fires and social damage, etc. that may ensue from the products' failure or malfunction.
The entire system in which the products are used must be sufficiently evaluated and judged whether the products are allowed to apply for the system on customer's own responsibility.
10. The products are not designed to be radiation-proof. The necessary radiation measures should be taken in the product design by the customer depending on the intended use.
11. The products do not affect human health under normal use. However, they contain chemical substances and heavy metals and should therefore not be put in the mouth. The fracture surfaces of wafers and chips may be sharp. Be careful when handling these with the bare hands to prevent injuries, etc.
12. When disposing of the products, comply with the laws and ordinances of the country or region where they are used.
13. The information described herein contains copyright information and know-how of ABLIC Inc. The information described herein does not convey any license under any intellectual property rights or any other rights belonging to ABLIC Inc. or a third party. Reproduction or copying of the information from this document or any part of this document described herein for the purpose of disclosing it to a third-party is strictly prohibited without the express permission of ABLIC Inc.
14. For more details on the information described herein or any other questions, please contact ABLIC Inc.'s sales representative.
15. This Disclaimers have been delivered in a text using the Japanese language, which text, despite any translations into the English language and the Chinese language, shall be controlling.

2.4-2019.07

Mouser Electronics

Authorized Distributor

Click to View Pricing, Inventory, Delivery & Lifecycle Information:

ABLIC:

[S-T111B15MC-OGATFG](#) [S-T111B16MC-OGBTFG](#) [S-T111B17MC-OGCTFG](#) [S-T111B18MC-OGDTFG](#) [S-T111B19MC-OGETFG](#) [S-T111B20MC-OGFTFG](#) [S-T111B21MC-OGGTFG](#) [S-T111B22MC-OGHTFG](#) [S-T111B23MC-OGITFG](#) [S-T111B24MC-OGJTFG](#) [S-T111B25MC-OGKTFG](#) [S-T111B26MC-OGLTFG](#) [S-T111B27MC-OGMTFG](#) [S-T111B28MC-OGNTFG](#) [S-T111B29MC-OGOTFG](#) [S-T111B30MC-OGPTFG](#) [S-T111B31MC-OGQTFG](#) [S-T111B32MC-OGRTFG](#) [S-T111B33MC-OGSTFG](#) [S-T111B34MC-OGTTFG](#) [S-T111B35MC-OGUTFG](#) [S-T111B36MC-OGVTFG](#) [S-T111B37MC-OGWTFG](#) [S-T111B38MC-OGXTFG](#) [S-T111B39MC-OGYTFG](#) [S-T111B40MC-OGZTFG](#) [S-T111B41MC-OHATFG](#) [S-T111B42MC-OHBTFG](#) [S-T111B43MC-OHCTFG](#) [S-T111B44MC-OHDTFG](#) [S-T111B45MC-OHETFG](#) [S-T111B46MC-OHFTFG](#) [S-T111B47MC-OHGTFG](#) [S-T111B48MC-OHHTFG](#) [S-T111B49MC-OHITFG](#) [S-T111B50MC-OHJTFG](#) [S-T111B51MC-OHKTFG](#) [S-T111B52MC-OHLTFG](#) [S-T111B53MC-OHMTFG](#) [S-T111B54MC-OHNTFG](#) [S-T111B55MC-OHOTFG](#) [S-T111B16MC-OGBTFU](#) [S-T111B38MC-OGXTFU](#) [S-T111B39MC-OGYTFU](#) [S-T111B52MC-OHLTFU](#) [S-T111B53MC-OHMTFU](#) [S-T111B55MC-OHOTFU](#) [S-T111B27MC-OGMTFU](#) [S-T111B30MC-OGPTFU](#) [S-T111B45MC-OHETFU](#) [S-T111B50MC-OHJTFU](#) [S-T111B48MC-OHHTFU](#) [S-T111B35MC-OGUTFU](#) [S-T111B31MC-OGQTFU](#) [S-T111B32MC-OGRTFU](#) [S-T111B17MC-OGCTFU](#) [S-T111B23MC-OGITFU](#) [S-T111B29MC-OGOTFU](#) [S-T111B18MC-OGDTFU](#) [S-T111B34MC-OGTTFU](#) [S-T111B36MC-OGVTFU](#) [S-T111B26MC-OGLTFU](#) [S-T111B47MC-OHGTFU](#) [S-T111B19MC-OGETFU](#) [S-T111B20MC-OGFTFU](#) [S-T111B43MC-OHCTFU](#) [S-T111B21MC-OGGTFU](#) [S-T111B42MC-OHBTFU](#) [S-T111B51MC-OHKTFU](#) [S-T111B28MC-OGNTFU](#) [S-T111B25MC-OGKTFU](#) [S-T111B33MC-OGSTFU](#) [S-T111B37MC-OGWTFU](#) [S-T111B49MC-OHITFU](#) [S-T111B41MC-OHATFU](#) [S-T111B44MC-OHDTFU](#) [S-T111B40MC-OGZTFU](#) [S-T111B15MC-OGATFU](#) [S-T111B24MC-OGJTFU](#) [S-T111B46MC-OHFTFU](#) [S-T111B54MC-OHNTFU](#) [S-T111B22MC-OGHTFU](#)



Компания «ЭлектроПласт» предлагает заключение долгосрочных отношений при поставках импортных электронных компонентов на взаимовыгодных условиях!

Наши преимущества:

- Оперативные поставки широкого спектра электронных компонентов отечественного и импортного производства напрямую от производителей и с крупнейших мировых складов;
- Поставка более 17-ти миллионов наименований электронных компонентов;
- Поставка сложных, дефицитных, либо снятых с производства позиций;
- Оперативные сроки поставки под заказ (от 5 рабочих дней);
- Экспресс доставка в любую точку России;
- Техническая поддержка проекта, помощь в подборе аналогов, поставка прототипов;
- Система менеджмента качества сертифицирована по Международному стандарту ISO 9001;
- Лицензия ФСБ на осуществление работ с использованием сведений, составляющих государственную тайну;
- Поставка специализированных компонентов (Xilinx, Altera, Analog Devices, Intersil, Interpoint, Microsemi, Aeroflex, Peregrine, Syfer, Eurofarad, Texas Instrument, Miteq, Cobham, E2V, MA-COM, Hittite, Mini-Circuits, General Dynamics и др.);

Помимо этого, одним из направлений компании «ЭлектроПласт» является направление «Источники питания». Мы предлагаем Вам помощь Конструкторского отдела:

- Подбор оптимального решения, техническое обоснование при выборе компонента;
- Подбор аналогов;
- Консультации по применению компонента;
- Поставка образцов и прототипов;
- Техническая поддержка проекта;
- Защита от снятия компонента с производства.



Как с нами связаться

Телефон: 8 (812) 309 58 32 (многоканальный)

Факс: 8 (812) 320-02-42

Электронная почта: org@eplast1.ru

Адрес: 198099, г. Санкт-Петербург, ул. Калинина, дом 2, корпус 4, литера А.