

# Safety Standard Recognized, ERK610, Encapsulated, X1 440 VAC/Y2 300 VAC (Industrial Grade)

## Overview

KEMET's ERK610 series encapsulated radial leaded ceramic disc capacitors are specifically designed for interference-suppression AC line filtering applications. Having internationally recognized safety certifications, these capacitors are well-suited for applications that require keeping potentially disruptive or damaging line transients and EMI out of susceptible equipment. They are also an ideal solution when needing to suppress line disturbances at the source.

Safety Certified Capacitors are classified as either X and/or Y capacitors. Class X capacitors are primarily used in line-to-line (across-the-line) applications.

In this application there is no danger of electric shock to humans should the capacitor fail, but could result in a risk of fire. The class Y capacitor is primarily used in line-to-ground (line by-pass) applications. In this application, failure of the capacitor could lead to danger of electric shock.

With a working voltage of 440 VAC in line-to-line (Class X) and 300 VAC in line-to-ground (Class Y) applications, these safety capacitors meet the impulse test criteria outlined in IEC Standard 60384. Meeting subclass X1 and Y2 requirements, these devices are certified to withstand impulses up to 4 KV (X1) and 5 KV (Y2) respectively. These encapsulated devices also meet the flame test requirements outlined in UL Standard 94 V-0.

## Benefits

- Safety Standard Recognized (IEC 60384-14)
- Reliable operation up to 125°C
- Class X1/Y2
- 5.0 mm, 7.5 mm, 10 mm, and 12.5 mm lead spacing
- RoHS compliant
- Capacitance offerings ranging from 33 pF up to 4.7 nF
- Available capacitance tolerances of  $\pm 10\%$  and  $\pm 20\%$
- High reliability
- Preformed (crimped) or straight lead configurations
- Non-polar device, minimizing installation concerns
- Encapsulation meets flammability standard UL 94 V-0

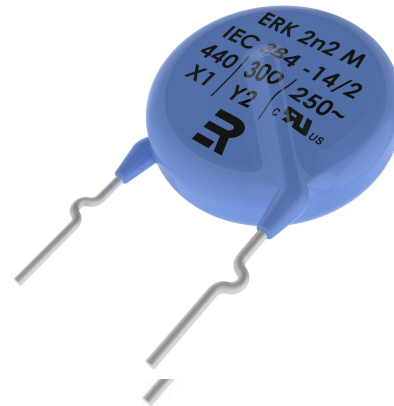

## Applications

- Line-to-Line (Class X) filtering
- Line-to-Ground (Class Y) filtering
- Antenna coupling
- Primary and secondary coupling (switching power supplies)
- Line disturbances suppression (motors and motor controls, relays, switching power supplies, and invertors)

## Ordering Information

ERK610	Z	102	K	CF0
Ceramic Series	Voltage Rating (Safety Subclass Rating)	Capacitance Code (pF)	Capacitance Tolerance	Lead configuration/ Packaging Code
ERK610	Z = X1 440 VAC/Y2 300 VAC	Two significant digits and number of zeroes	K = ±10% M = ±20%	*See Packaging Options

## Packaging C-Spec Ordering Options Tables

Bulk Packaging						
	LEAD LENGTH L	LEAD DIAMETER D	LEAD SPACING F			
			5 mm	7.5 mm	10 mm	12.5 mm
Straight leads	30 mm – 3 mm	0.6 mm	BF0	CF0	DF0	EF0
		0.8 mm		CJ0	DJ0	EJ0
	10 mm ±1 mm	0.6 mm	BD0	CD0	DD0	ED0
		0.8 mm		CH0	DH0	EH0
6 mm – 1 mm	0.6 mm/0.8 mm	BB0	CB0	DB0	EB0	
Preformed leads inside crimp	30 mm – 3 mm	0.6 mm			DFG	EFG
		0.8 mm			DJG	EJG
Preformed leads outside crimp	5 mm ±1 mm	0.6 mm	TA0	TC0	TE0	TG0
		0.8 mm		TD0	TF0	TH0
Preformed leads snap-in	Minimum 2.8 mm	0.6 mm			QE0	QG0
	Minimum 3.5 mm	0.8 mm			QF0	QH0
Inline wire	Minimum 2.8 mm + 1.5 mm	0.6 mm	YA0	YC0	YE0	YG0
	Minimum 3.0 mm + 2.0 mm	0.8 mm	YB0	YD0	YF0	YH0

Reel Packaging Component Pitch 12.7 mm <sup>1,2</sup>						
	TAPING P		TAPING T		TAPING U	
Lead diameter 0.6 mm	H = 16.5 mm		H = 18.0 mm straight leads only H0 = 16.0 mm preformed leads only		H = 20.0 mm	
Lead spacing F	5 mm	7.5 mm	5 mm	7.5 mm	5 mm	7.5 mm
Body diameter D	Valid for ≤ 12 mm standard (> 12 mm to ≤ 13 mm on request)					
Straight leads		CRE	BRA	CRA	BRC	CRC
Preformed leads inside crimp						
Preformed leads outside crimp			TAR	TCR		
Preformed leads 7.5 mm to 5 mm			UAR			
Preformed leads snap-in						
Inline wire				YCR		

<sup>1</sup> When requiring the 12.7 mm pitch option, 5 mm and 7.5 mm lead spacing is only available for body diameters less than or equal to 12 mm. See Product Ordering Codes and Ratings (Table 1) for Body Diameter.

<sup>2</sup> 10 mm and 12.5 mm lead spacing options are not available in 12.7 mm pitch.

## Packaging C-Spec Ordering Options Tables cont.

Reel Packaging Component Pitch 25.4 mm <sup>1,2</sup>					
		TAPING F			
Lead spacing F		5 mm	7.5 mm	10 mm	12.5 mm
Body diameter D		> 12 mm		All diameters	
Straight leads	H = 16.5 mm	BRT	CRT	DRT	ERT
	H = 18.0 mm	BRU	CRU	DRU	ERU
	H = 20.0 mm	BRY	CRY	DRY	ERY
Preformed leads inside crimp	H0 = 16.0 mm			DRZ	ERZ
Preformed leads outside crimp	H0 = 16.0 mm			TDR	TER
Inline wire	H0 = 16.0 mm	YRB	YRC	YRD	YRE

<sup>1</sup> When requiring the 25.4 mm pitch option, 5 mm and 7.5 mm lead spacing is only available for body diameters greater than 12 mm. See Product Ordering Codes and Ratings (Table 1) for Body Diameter.

<sup>2</sup> 10 mm and 12.5 mm lead spacing is available for all body diameters.

Ammo Packaging Component Pitch 12.7 mm <sup>1,2</sup>				
	TAPING P	TAPING T		TAPING U
Lead diameter 0.6 mm	H = 16.5 mm	H = 18.0 mm straight leads only H0 = 16.0 mm preformed leads only		H = 20.0 mm
Lead spacing F	5 mm	5 mm	7.5 mm	5 mm
Body diameter D	Valid for ≤ 12 mm standard (> 12 mm to ≤ 13 mm on request)			
Straight leads	BLE	BLA	CLA	BLC
Preformed leads inside crimp				
Preformed leads 7.5 mm to 5 mm		UAL		
Inline wire		YAL	YLC	

<sup>1</sup> When requiring the 12.7 mm pitch option, 5 mm and 7.5 mm lead spacing is only available for body diameters less than or equal to 12 mm. See Product Ordering Codes and Ratings (Table 1) for Body Diameter.

<sup>2</sup> 10 mm and 12.5 mm lead spacing options are not available in 12.7 mm pitch.

## Approval Standard and Certification Number

Safety Standard	Specification	Certificate Number
VDE (ENEC)	EN 132400	<a href="#">40001991, 40001992</a>
UL CAN/CSA	UL 60384-14 and E60384-14	<a href="#">E356389</a>

*These devices are VDE/ENEC recognized for antenna coupling and AC line-to-line (Class X) and line-to-ground (Class Y) applications per IEC60384-14.*

## Environmental Compliance

These devices are RoHS compliant. They meet all the requirements set forth by both EU and China RoHS directives.



## Lead Configurations

Straight Leads		Inside Kink		Outside Kink							
Φd	0.6 or 0.8	Φd	0.6 or 0.8	Φd	0.6	0.6 or 0.8					
L	30-3 or 10±1	F	7.5	10	12.5	F	5.0	7.5	7.5	10.0	12.5
F	5	A	4.0±1.5	5.0±1.5	6.0±1.5	A	5.0	5.0	6.0	6.0	6.0
e	3.0 mm maximum	L	3.0 mm minimum Tolerance: 1.0 mm absolute								

5 mm to 7.5 mm		Snap-In Leads		Vertical Crimp				
Φd	0.6	Φd	0.6	0.8	F	7.5	10	12.5
B	D - 9: 6.8±0.7 D >9: 7.5±0.7	F	7.5/10/12.5		D	0.6	0.8	0.8
L	2.0 mm minimum Tolerance: 2.0 mm absolute	L	2.8 mm minimum 3.5 mm minimum		A	4.5 maximum	6.0 maximum	6.0 maximum
		H	2.6		L			
		P1	1.25		2.8 minimum			
		P2	1.65		1.5 absolute			
		A	D - 8: 6.0±1.5 D > 8: 7.0±1.5		2.0 absolute			

## General Specifications/Performance Characteristics

Dielectric/Temperature Characteristic	U2J	Y5S	Y5T	Y5U
Operating Temperature Range:	-40°C to +125°C			
Capacitance Change with Reference to +25°C and 0 VDC Applied (TCC):	±60 ppm/°C	±22%	+22%/-33%	22%/-56%
Test Voltage Between Terminals	Component test: 2,600 VAC, 50 Hz, 2 seconds As repeated test admissible only once with 2,600 VAC, 50 Hz, 60 seconds Random sampling test (destructive test): 2,600 VAC, 50 Hz, 60 seconds			
Dielectric Strength of Body Insulation	2,600 VAC, 50 Hz, 60 seconds (destructive test)			
<sup>1</sup> Dissipation Factor (tanδ) at +25°C <sup>1</sup>	0.50%	2.50%		
Insulation Resistance (IR) Limit at +25°C	6,000 MΩ minimum (500 VDC applied for 60 ±5 seconds at 25°C)			

\*C = Nominal capacitance

<sup>1</sup> Capacitance and Dissipation Factor (DF) measured under the following conditions:

U2J: 1 MHz ±100 kHz and 1.0 ±0.2 V<sub>rms</sub>

Y5S, Y5T and Y5U: 1 kHz ±50 Hz and 1.0 ±0.2 V<sub>rms</sub>

Note: When measuring capacitance, it is important to ensure the set voltage level is held constant. The HP4284 & Agilent E4980 have a feature known as Automatic Level Control (ALC). The ALC feature should be switched to "ON."

## Table 1 – Product Ordering Codes and Ratings

Dielectric/ Temp. Char.	KEMET Part Number	Capacitance	Capacitance Tolerance	Dimensions (mm)				Lead Spacing	
				Body Diameter (Maximum)	Body Thickness (Maximum)	Lead Diameter	Width V ±0.5 mm	Bulk Packaging	Ammo Packaging
U2J	ERK610Z330	33 pF	±10% ±20%	8.0	6.0	0.6 0.8	1.6	5 7.5 10 12.5	
	ERK610Z470	47 pF							
Y5S	ERK610Z680	68 pF							
	ERK610Z101	100 pF							
Y5T	ERK610Z151	150 pF							
	ERK610Z221	220 pF							
Y5U	ERK610Z331	330 pF		9.0	4.5	1.9	2		
	ERK610Z471	470 pF							
	ERK610Z681	680 pF							
	ERK610Z102	1,000 pF							
	ERK610Z152	1,500 pF							
	ERK610Z222	2,200 pF							
	ERK610Z332	3,300 pF							
	ERK610Z392	3,900 pF							
ERK610Z472	4,700 pF	13.5							
	<b>KEMET Part Number</b>	<b>Capacitance</b>	<b>Capacitance Tolerance</b>	<b>Body Diameter (Maximum)</b>	<b>Body Thickness (Maximum)</b>	<b>Lead Diameter</b>	<b>Width V ±0.5 mm</b>	<b>Lead Spacing</b>	

To properly complete ordering code, enter the three-digit alphanumeric "Packaging Code." See "Dimensions" section of this document, page 2, for available options.

## Soldering and Mounting Information

Soldering Specifications		
	Solderability	Resistance to Soldering Heat
Soldering Temperature	235°C ±5°C	260°C ±5°C
Solder Duration	2 seconds ±0.5 seconds	10 seconds ±1.0 seconds
Distance from component body	≥ 2 mm	≥ 5 mm
CSA (cUL recognition)	C 22.2 No. 1-M90 (Ur = 250 VAC)	216038

Soldering test for capacitors with wire leads (according to IEC 60068-2-20, solder bath method)

### Soldering Recommendations

When soldering this product to a PCB/PWB, do not exceed the solder heat resistance specification of the capacitor. Subjecting this product to excessive heating could reflow the solder joint between the lead and ceramic element and/or may result in thermal shocks that can crack the ceramic element.

### Cleaning Recommendations

The components should be cleaned immediately following the soldering operation with vapor degreasers.

## Marking

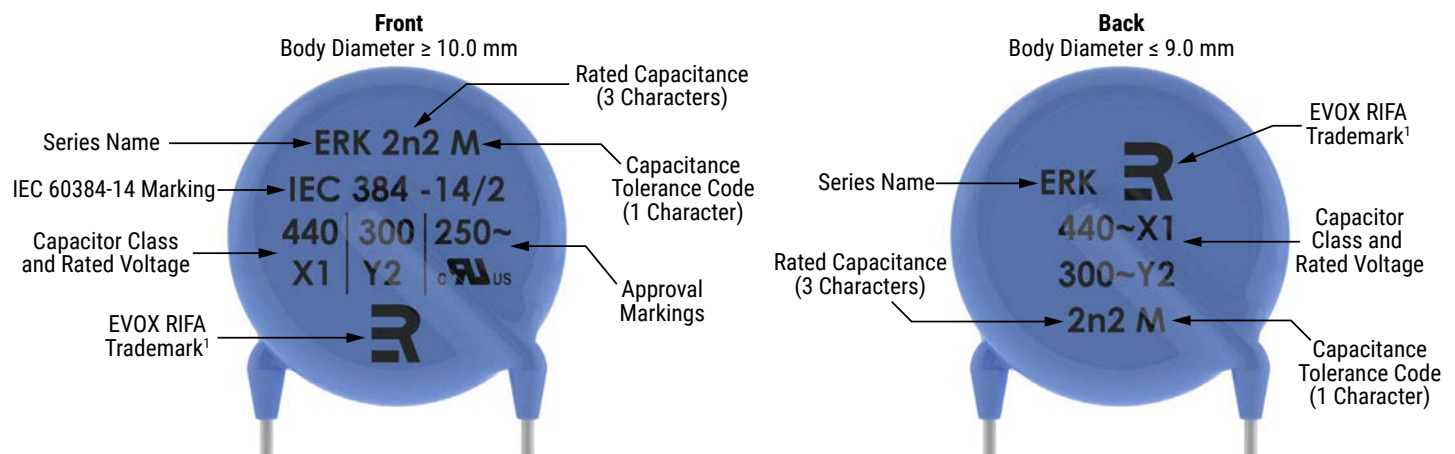

<sup>1</sup> EVOX RIFA and all associated products were acquired by KEMET in 2007. The EVOX RIFA trademark is still used on the capacitor marking.

## Figure 1 - Ammo Pack Taping Format

### TAPING P/T/U

COMPONENT PITCH 0.5 inch

LEAD SPACING 5.0 mm

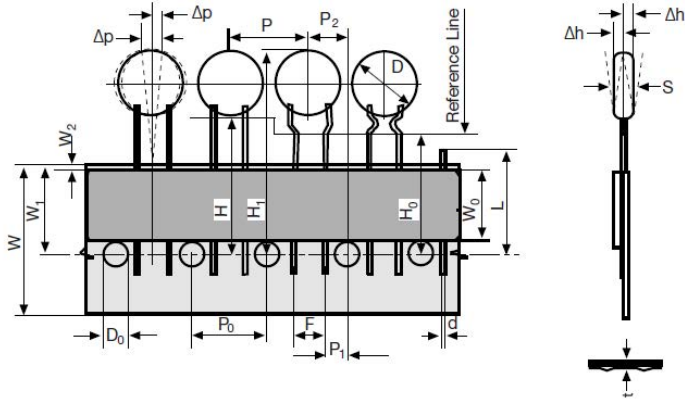

### TAPING P/T/U

COMPONENT PITCH 0.5 inch

LEAD SPACING 7.5 mm



### TAPING F

COMPONENT PITCH 1.0 inch

LEAD SPACING 5.0 mm, 7.5 mm, 10.0 mm, and 12.5 mm





**Table 2 – Ammo Pack Taping Specifications**

Lead Style		TAPING P	TAPING T	TAPING U	TAPING F
Item	Symbol	Dimensions(mm)			
Pitch of component	P	12.7±1			25.4 ±1
Pitch of sprocket hole	P0	12.7±0.3			12.7 ±0.3
Distance, hole to lead	P1	3.85±0.7			(0.5F) ±0.7
Distance, hole to center of component	P2	6.35±1.3			12.7 ±1.3
Lead spacing	F	5.0/7.5 +0.8/-0.2			5/7.5/10/12.5 ±0.8
Average deviation across tape	Δh	±2.0 maximum			±3.0 maximum
Average deviation in direction of reeling	Δp	±1.3 maximum			±1.3 maximum
Carrier tape width	W	18.0 +1/-0.5			18.0 +1/-0.5
Hold-down tape width	W0	6			6
Position of sprocket hole	W1	9.0 +0.75/-0.5			9.0 +0.75/-0.5
Distance of hold-down tape	W2	3.0 maximum			3.0 maximum
Distance between the abscissa and the bottom place of the component body (straight leads)	H	16.5 ±0.5	18.0 +2/-0	20 ±1	16.5 ±0.5 18.0 +2/-0 20.0 ±1
Distance between the abscissa and the bottom place of the component body (kinked leads)	H0	16.0 ±0.5			16.0 ±0.5
Length of cut leads	L	11.0 maximum			11.0 maximum
Diameter of sprocket hole	D0	4.0 ±0.2			4.0 ±0.2
Total tape thickness	t	0.9 maximum			0.9 maximum

<sup>1</sup> Prefromed (crimped) lead configurations include vertical kink, outside kink and inside kink. See "Lead Configurations" and "Ordering Information" sections of this document for further details.

<sup>2</sup> Also referred to as "lead length" in this document.

## Application Notes

### Storage and Operating Conditions

The insulating coating of these devices does not form an air and moisture-tight seal. Avoid exposure to moisture and do not use or store these devices in a corrosive atmosphere, especially where chloride gas, sulfide gas, acid, alkali, salt, or the like are present. Before cleaning, bonding or molding these devices, it is important to verify that your process does not affect product quality and performance. KEMET recommends testing and evaluating the performance of a cleaned, bonded or molded product prior to implementing and/or qualifying any of these processes. Store the capacitors where the temperature and relative humidity do not exceed 40 degrees centigrade and 70% respectively. For optimum solderability, capacitor stock should be used promptly, preferably within 6 months of receipt.

### Working Voltage

Application voltage ( $V_{p-p}$  or  $V_{o-p}$ ) must not exceed the voltage rating of the capacitor. Irregular voltages can be generated for a transient period of time when voltage is initially applied and/or removed from a circuit. It is important to choose a capacitor with a voltage rating greater than or equal to these irregular voltages.

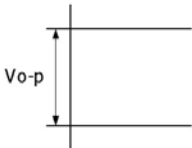
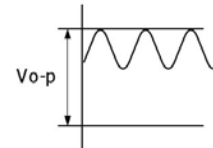
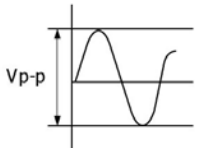
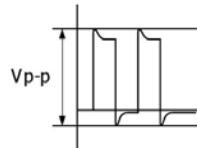
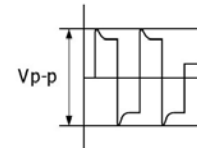
Voltage	DC Voltage	DC+AC Voltage	AC Voltage	Pulse Voltage (1)	Pulse Voltage (2)
Positional Measurement					

### Operating Temperature and Self-Generating Heat

The surface temperature of a capacitor should be kept below the upper limit of its rated operating temperature range. Be sure to take into account the heat generated by the capacitor itself. When the capacitor is used in a high-frequency current, pulse current or similar current, it may self-generate heat due to dielectric loss. Temperature rise due to self-generated heating should not exceed 20°C (while operated at an atmosphere temperature of 25°C).

### Handling - Vibration and Impact

Do not expose these devices or their leads to excessive shock or vibration during use.

**FAILURE TO FOLLOW THE ABOVE CAUTIONS MAY RESULT, WORST CASE, IN A SHORT CIRCUIT AND CAUSE FUMING OR PARTIAL DISPERSION WHEN THE PRODUCT IS USED.**

## KEMET Electronics Corporation Sales Offices

For a complete list of our global sales offices, please visit [www.kemet.com/sales](http://www.kemet.com/sales).

---

### Disclaimer

All product specifications, statements, information and data (collectively, the "Information") in this datasheet are subject to change. The customer is responsible for checking and verifying the extent to which the Information contained in this publication is applicable to an order at the time the order is placed. All Information given herein is believed to be accurate and reliable, but it is presented without guarantee, warranty, or responsibility of any kind, expressed or implied.

Statements of suitability for certain applications are based on KEMET Electronics Corporation's ("KEMET") knowledge of typical operating conditions for such applications, but are not intended to constitute – and KEMET specifically disclaims – any warranty concerning suitability for a specific customer application or use. The Information is intended for use only by customers who have the requisite experience and capability to determine the correct products for their application. Any technical advice inferred from this Information or otherwise provided by KEMET with reference to the use of KEMET's products is given gratis, and KEMET assumes no obligation or liability for the advice given or results obtained.

Although KEMET designs and manufactures its products to the most stringent quality and safety standards, given the current state of the art, isolated component failures may still occur. Accordingly, customer applications which require a high degree of reliability or safety should employ suitable designs or other safeguards (such as installation of protective circuitry or redundancies) in order to ensure that the failure of an electrical component does not result in a risk of personal injury or property damage.

Although all product-related warnings, cautions and notes must be observed, the customer should not assume that all safety measures are indicated or that other measures may not be required.

*KEMET is a registered trademark of KEMET Electronics Corporation.*



Компания «ЭлектроПласт» предлагает заключение долгосрочных отношений при поставках импортных электронных компонентов на взаимовыгодных условиях!

Наши преимущества:

- Оперативные поставки широкого спектра электронных компонентов отечественного и импортного производства напрямую от производителей и с крупнейших мировых складов;
- Поставка более 17-ти миллионов наименований электронных компонентов;
- Поставка сложных, дефицитных, либо снятых с производства позиций;
- Оперативные сроки поставки под заказ (от 5 рабочих дней);
- Экспресс доставка в любую точку России;
- Техническая поддержка проекта, помощь в подборе аналогов, поставка прототипов;
- Система менеджмента качества сертифицирована по Международному стандарту ISO 9001;
- Лицензия ФСБ на осуществление работ с использованием сведений, составляющих государственную тайну;
- Поставка специализированных компонентов (Xilinx, Altera, Analog Devices, Intersil, Interpoint, Microsemi, Aeroflex, Peregrine, Syfer, Eurofarad, Texas Instrument, Miteq, Cobham, E2V, MA-COM, Hittite, Mini-Circuits, General Dynamics и др.);

Помимо этого, одним из направлений компании «ЭлектроПласт» является направление «Источники питания». Мы предлагаем Вам помощь Конструкторского отдела:

- Подбор оптимального решения, техническое обоснование при выборе компонента;
- Подбор аналогов;
- Консультации по применению компонента;
- Поставка образцов и прототипов;
- Техническая поддержка проекта;
- Защита от снятия компонента с производства.



#### Как с нами связаться

**Телефон:** 8 (812) 309 58 32 (многоканальный)

**Факс:** 8 (812) 320-02-42

**Электронная почта:** [org@eplast1.ru](mailto:org@eplast1.ru)

**Адрес:** 198099, г. Санкт-Петербург, ул. Калинина, дом 2, корпус 4, литера А.