

# Safety Standard Recognized, ERK610, Encapsulated, X1 440 VAC/Y2 300 VAC (Industrial Grade)

## Overview

KEMET's ERK610 series encapsulated radial leaded ceramic disc capacitors are specifically designed for interference-suppression AC line filtering applications. Having internationally recognized safety certifications, these capacitors are well-suited for applications that require keeping potentially disruptive or damaging line transients and EMI out of susceptible equipment. They are also an ideal solution when needing to suppress line disturbances at the source.

Safety Certified Capacitors are classified as either X and/or Y capacitors. Class X capacitors are primarily used in line-to-line (across-the-line) applications.

In this application there is no danger of electric shock to humans should the capacitor fail, but could result in a risk of fire. The class Y capacitor is primarily used in line-to-ground (line by-pass) applications. In this application, failure of the capacitor could lead to danger of electric shock.

With a working voltage of 440 VAC in line-to-line (Class X) and 300 VAC in line-to-ground (Class Y) applications, these safety capacitors meet the impulse test criteria outlined in IEC Standard 60384. Meeting subclass X1 and Y2 requirements, these devices are certified to withstand impulses up to 4 KV (X1) and 5 KV (Y2) respectively. These encapsulated devices also meet the flame test requirements outlined in UL Standard 94 V-0.

## Benefits

- Safety Standard Recognized (IEC 60384-14)
- Reliable operation up to 125°C
- Class X1/Y2
- 5.0 mm, 7.5 mm, 10 mm, and 12.5 mm lead spacing
- RoHS compliant
- Capacitance offerings ranging from 33 pF up to 4.7 nF
- Available capacitance tolerances of  $\pm 10\%$  and  $\pm 20\%$
- High reliability
- Preformed (crimped) or straight lead configurations
- Non-polar device, minimizing installation concerns
- Encapsulation meets flammability standard UL 94 V-0

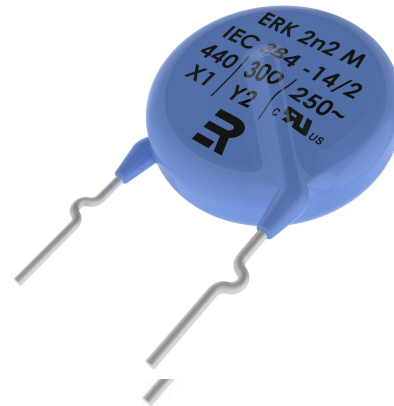

## Applications

- Line-to-Line (Class X) filtering
- Line-to-Ground (Class Y) filtering
- Antenna coupling
- Primary and secondary coupling (switching power supplies)
- Line disturbances suppression (motors and motor controls, relays, switching power supplies, and invertors)

## Ordering Information

| ERK610         | Z                                       | 102   | K                     | CF0                                |
|----------------|---|---|-----------------------|------------------------------------|
| Ceramic Series | Voltage Rating (Safety Subclass Rating) | Capacitance Code (pF)                       | Capacitance Tolerance | Lead configuration/ Packaging Code |
| ERK610         | Z = X1 440 VAC/Y2 300 VAC               | Two significant digits and number of zeroes | K = ±10%<br>M = ±20%  | *See Packaging Options             |

## Packaging C-Spec Ordering Options Tables

| Bulk Packaging                |                         |                 |                |        |       |         |
|-------------------------------|-------------------------|-----------------|----------------|--------|-------|---------|
|                               | LEAD LENGTH L           | LEAD DIAMETER D | LEAD SPACING F |        |       |         |
|                               |                         |                 | 5 mm           | 7.5 mm | 10 mm | 12.5 mm |
| Straight leads                | 30 mm – 3 mm            | 0.6 mm          | BF0            | CF0    | DF0   | EF0     |
|                               |                         | 0.8 mm          |                | CJ0    | DJ0   | EJ0     |
|                               | 10 mm ±1 mm             | 0.6 mm          | BD0            | CD0    | DD0   | ED0     |
|                               |                         | 0.8 mm          |                | CH0    | DH0   | EH0     |
| 6 mm – 1 mm                   | 0.6 mm/0.8 mm           | BB0             | CB0            | DB0    | EB0   |         |
| Preformed leads inside crimp  | 30 mm – 3 mm            | 0.6 mm          |                |        | DFG   | EFG     |
|                               |                         | 0.8 mm          |                |        | DJG   | EJG     |
| Preformed leads outside crimp | 5 mm ±1 mm              | 0.6 mm          | TA0            | TC0    | TE0   | TG0     |
|                               |                         | 0.8 mm          |                | TD0    | TF0   | TH0     |
| Preformed leads snap-in       | Minimum 2.8 mm          | 0.6 mm          |                |        | QE0   | QG0     |
|                               | Minimum 3.5 mm          | 0.8 mm          |                |        | QF0   | QH0     |
| Inline wire                   | Minimum 2.8 mm + 1.5 mm | 0.6 mm          | YA0            | YC0    | YE0   | YG0     |
|                               | Minimum 3.0 mm + 2.0 mm | 0.8 mm          | YB0            | YD0    | YF0   | YH0     |

| Reel Packaging Component Pitch 12.7 mm <sup>1,2</sup> |  |        |  |        |             |        |
|---|--|--------|--|--------|-------------|--------|
|   | TAPING P   |        | TAPING T   |        | TAPING U    |        |
| Lead diameter 0.6 mm                                  | H = 16.5 mm  |        | H = 18.0 mm straight leads only<br>H0 = 16.0 mm preformed leads only |        | H = 20.0 mm |        |
| Lead spacing F  | 5 mm   | 7.5 mm | 5 mm   | 7.5 mm | 5 mm        | 7.5 mm |
| Body diameter D                                       | Valid for ≤ 12 mm standard (> 12 mm to ≤ 13 mm on request) |        |  |        |             |        |
| Straight leads  |  | CRE    | BRA  | CRA    | BRC         | CRC    |
| Preformed leads inside crimp                          |  |        |  |        |             |        |
| Preformed leads outside crimp                         |  |        | TAR  | TCR    |             |        |
| Preformed leads 7.5 mm to 5 mm                        |  |        | UAR  |        |             |        |
| Preformed leads snap-in                               |  |        |  |        |             |        |
| Inline wire   |  |        |  | YCR    |             |        |

<sup>1</sup> When requiring the 12.7 mm pitch option, 5 mm and 7.5 mm lead spacing is only available for body diameters less than or equal to 12 mm. See Product Ordering Codes and Ratings (Table 1) for Body Diameter.

<sup>2</sup> 10 mm and 12.5 mm lead spacing options are not available in 12.7 mm pitch.

## Packaging C-Spec Ordering Options Tables cont.

| Reel Packaging Component Pitch 25.4 mm <sup>1,2</sup> |              |          |        |               |         |
|---|--------------|----------|--------|---------------|---------|
|   |              | TAPING F |        |               |         |
| Lead spacing F  |              | 5 mm     | 7.5 mm | 10 mm         | 12.5 mm |
| Body diameter D                                       |              | > 12 mm  |        | All diameters |         |
| Straight leads  | H = 16.5 mm  | BRT      | CRT    | DRT           | ERT     |
|   | H = 18.0 mm  | BRU      | CRU    | DRU           | ERU     |
|   | H = 20.0 mm  | BRY      | CRY    | DRY           | ERY     |
| Preformed leads inside crimp                          | H0 = 16.0 mm |          |        | DRZ           | ERZ     |
| Preformed leads outside crimp                         | H0 = 16.0 mm |          |        | TDR           | TER     |
| Inline wire   | H0 = 16.0 mm | YRB      | YRC    | YRD           | YRE     |

<sup>1</sup> When requiring the 25.4 mm pitch option, 5 mm and 7.5 mm lead spacing is only available for body diameters greater than 12 mm. See Product Ordering Codes and Ratings (Table 1) for Body Diameter.

<sup>2</sup> 10 mm and 12.5 mm lead spacing is available for all body diameters.

| Ammo Packaging Component Pitch 12.7 mm <sup>1,2</sup> |  |  |        |             |
|---|--|--|--------|-------------|
|   | TAPING P   | TAPING T   |        | TAPING U    |
| Lead diameter 0.6 mm                                  | H = 16.5 mm  | H = 18.0 mm straight leads only<br>H0 = 16.0 mm preformed leads only |        | H = 20.0 mm |
| Lead spacing F  | 5 mm   | 5 mm   | 7.5 mm | 5 mm        |
| Body diameter D                                       | Valid for ≤ 12 mm standard (> 12 mm to ≤ 13 mm on request) |  |        |             |
| Straight leads  | BLE  | BLA  | CLA    | BLC         |
| Preformed leads inside crimp                          |  |  |        |             |
| Preformed leads 7.5 mm to 5 mm                        |  | UAL  |        |             |
| Inline wire   |  | YAL  | YLC    |             |

<sup>1</sup> When requiring the 12.7 mm pitch option, 5 mm and 7.5 mm lead spacing is only available for body diameters less than or equal to 12 mm. See Product Ordering Codes and Ratings (Table 1) for Body Diameter.

<sup>2</sup> 10 mm and 12.5 mm lead spacing options are not available in 12.7 mm pitch.

## Approval Standard and Certification Number

| Safety Standard | Specification                | Certificate Number                 |
|-----------------|------------------------------|------------------------------------|
| VDE<br>(ENEC)   | EN 132400                    | <a href="#">40001991, 40001992</a> |
| UL<br>CAN/CSA   | UL 60384-14 and<br>E60384-14 | <a href="#">E356389</a>            |

*These devices are VDE/ENEC recognized for antenna coupling and AC line-to-line (Class X) and line-to-ground (Class Y) applications per IEC60384-14.*

## Environmental Compliance

These devices are RoHS compliant. They meet all the requirements set forth by both EU and China RoHS directives.



## Lead Configurations

| Straight Leads |                | Inside Kink |  | Outside Kink |         |            |     |     |     |      |      |
|----------------|----------------|-------------|--|--------------|---------|------------|-----|-----|-----|------|------|
|                |                |             |  |              |         |            |     |     |     |      |      |
| Φd             | 0.6 or 0.8     | Φd          | 0.6 or 0.8                                   | Φd           | 0.6     | 0.6 or 0.8 |     |     |     |      |      |
| L              | 30-3 or 10±1   | F           | 7.5  | 10           | 12.5    | F          | 5.0 | 7.5 | 7.5 | 10.0 | 12.5 |
| F              | 5              | A           | 4.0±1.5                                      | 5.0±1.5      | 6.0±1.5 | A          | 5.0 | 5.0 | 6.0 | 6.0  | 6.0  |
| e              | 3.0 mm maximum | L           | 3.0 mm minimum<br>Tolerance: 1.0 mm absolute |              |         |            |     |     |     |      |      |

| 5 mm to 7.5 mm |  | Snap-In Leads |                                  | Vertical Crimp |              |             |             |             |
|----------------|--|---------------|----------------------------------|----------------|--------------|-------------|-------------|-------------|
|                |  |               |                                  |                |              |             |             |             |
| Φd             | 0.6  | Φd            | 0.6                              | 0.8            | F            | 7.5         | 10          | 12.5        |
| B              | D - 9: 6.8±0.7 D >9: 7.5±0.7                 | F             | 7.5/10/12.5                      |                | D            | 0.6         | 0.8         | 0.8         |
| L              | 2.0 mm minimum<br>Tolerance: 2.0 mm absolute | L             | 2.8 mm minimum<br>3.5 mm minimum |                | A            | 4.5 maximum | 6.0 maximum | 6.0 maximum |
|                |  | H             | 2.6                              |                | L            |             |             |             |
|                |  | P1            | 1.25                             |                | 2.8 minimum  |             |             |             |
|                |  | P2            | 1.65                             |                | 1.5 minimum  |             |             |             |
|                |  | A             | D - 8: 6.0±1.5 D > 8: 7.0±1.5    |                | 2.0 absolute |             |             |             |

## General Specifications/Performance Characteristics

| Dielectric/Temperature Characteristic                               | U2J  | Y5S   | Y5T       | Y5U      |
|---|--|-------|-----------|----------|
| Operating Temperature Range:  | -40°C to +125°C  |       |           |          |
| Capacitance Change with Reference to +25°C and 0 VDC Applied (TCC): | ±60 ppm/°C   | ±22%  | +22%/-33% | 22%/-56% |
| Test Voltage Between Terminals                                      | Component test:<br>2,600 VAC, 50 Hz, 2 seconds<br>As repeated test admissible only once with<br>2,600 VAC, 50 Hz, 60 seconds<br>Random sampling test (destructive test):<br>2,600 VAC, 50 Hz, 60 seconds |       |           |          |
| Dielectric Strength of Body Insulation                              | 2,600 VAC, 50 Hz, 60 seconds (destructive test)  |       |           |          |
| <sup>1</sup> Dissipation Factor (tanδ) at +25°C <sup>1</sup>        | 0.50%  | 2.50% |           |          |
| Insulation Resistance (IR) Limit at +25°C                           | 6,000 MΩ minimum<br>(500 VDC applied for 60 ±5 seconds at 25°C)  |       |           |          |

\*C = Nominal capacitance

<sup>1</sup> Capacitance and Dissipation Factor (DF) measured under the following conditions:

U2J: 1 MHz ±100 kHz and 1.0 ±0.2 V<sub>rms</sub>

Y5S, Y5T and Y5U: 1 kHz ±50 Hz and 1.0 ±0.2 V<sub>rms</sub>

Note: When measuring capacitance, it is important to ensure the set voltage level is held constant. The HP4284 & Agilent E4980 have a feature known as Automatic Level Control (ALC). The ALC feature should be switched to "ON."

## Table 1 – Product Ordering Codes and Ratings

| Dielectric/<br>Temp. Char. | KEMET<br>Part Number | Capacitance | Capacitance<br>Tolerance | Dimensions (mm)               |                                |                  |                       | Lead Spacing           |                   |
|----------------------------|----------------------|-------------|--------------------------|-------------------------------|--------------------------------|------------------|-----------------------|------------------------|-------------------|
|                            |                      |             |                          | Body<br>Diameter<br>(Maximum) | Body<br>Thickness<br>(Maximum) | Lead<br>Diameter | Width<br>V<br>±0.5 mm | Bulk<br>Packaging      | Ammo<br>Packaging |
| U2J                        | ERK610Z330           | 33 pF       | ±10%<br>±20%             | 8.0                           | 6.0                            | 0.6<br>0.8       | 1.6                   | 5<br>7.5<br>10<br>12.5 |                   |
|                            | ERK610Z470           | 47 pF       |                          |                               |                                |                  |                       |                        |                   |
| Y5S                        | ERK610Z680           | 68 pF       |                          |                               |                                |                  |                       |                        |                   |
|                            | ERK610Z101           | 100 pF      |                          |                               |                                |                  |                       |                        |                   |
| Y5T                        | ERK610Z151           | 150 pF      |                          |                               |                                |                  |                       |                        |                   |
|                            | ERK610Z221           | 220 pF      |                          |                               |                                |                  |                       |                        |                   |
| Y5U                        | ERK610Z331           | 330 pF      |                          | 9.0                           | 4.5                            | 1.9              | 2                     |                        |                   |
|                            | ERK610Z471           | 470 pF      |                          |                               |                                |                  |                       |                        |                   |
|                            | ERK610Z681           | 680 pF      |                          |                               |                                |                  |                       |                        |                   |
|                            | ERK610Z102           | 1,000 pF    |                          |                               |                                |                  |                       |                        |                   |
|                            | ERK610Z152           | 1,500 pF    |                          |                               |                                |                  |                       |                        |                   |
|                            | ERK610Z222           | 2,200 pF    |                          |                               |                                |                  |                       |                        |                   |
|                            | ERK610Z332           | 3,300 pF    |                          |                               |                                |                  |                       |                        |                   |
|                            | ERK610Z392           | 3,900 pF    |                          |                               |                                |                  |                       |                        |                   |
| ERK610Z472                 | 4,700 pF             | 13.5        |                          |                               |                                |                  |                       |                        |                   |
|                            | KEMET<br>Part Number | Capacitance | Capacitance<br>Tolerance | Body Diameter<br>(Maximum)    | Body Thickness<br>(Maximum)    | Lead Diameter    | Width<br>V<br>±0.5 mm | Lead Spacing           |                   |

To properly complete ordering code, enter the three-digit alphanumeric "Packaging Code." See "Dimensions" section of this document, page 2, for available options.

## Soldering and Mounting Information

| Soldering Specifications     |                                 |                              |
|------------------------------|---------------------------------|------------------------------|
|                              | Solderability                   | Resistance to Soldering Heat |
| Soldering Temperature        | 235°C ±5°C                      | 260°C ±5°C                   |
| Solder Duration              | 2 seconds ±0.5 seconds          | 10 seconds ±1.0 seconds      |
| Distance from component body | ≥ 2 mm                          | ≥ 5 mm                       |
| CSA (cUL recognition)        | C 22.2 No. 1-M90 (Ur = 250 VAC) | 216038                       |

Soldering test for capacitors with wire leads (according to IEC 60068-2-20, solder bath method)

### Soldering Recommendations

When soldering this product to a PCB/PWB, do not exceed the solder heat resistance specification of the capacitor. Subjecting this product to excessive heating could reflow the solder joint between the lead and ceramic element and/or may result in thermal shocks that can crack the ceramic element.

### Cleaning Recommendations

The components should be cleaned immediately following the soldering operation with vapor degreasers.

## Marking

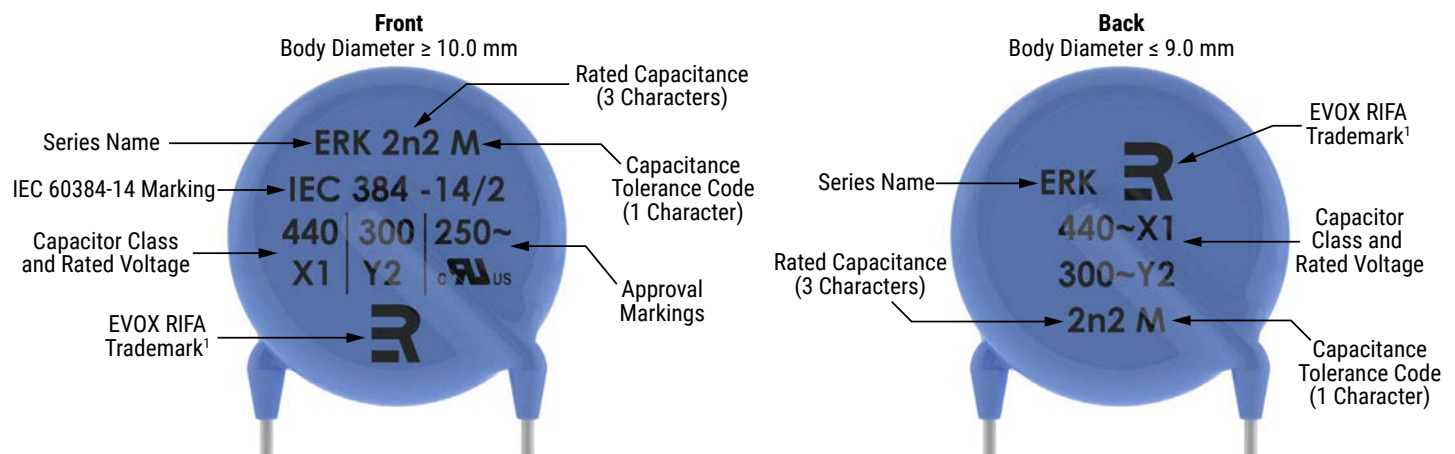

<sup>1</sup> EVOX RIFA and all associated products were acquired by KEMET in 2007. The EVOX RIFA trademark is still used on the capacitor marking.

## Figure 1 - Ammo Pack Taping Format

### TAPING P/T/U

COMPONENT PITCH 0.5 inch

LEAD SPACING 5.0 mm

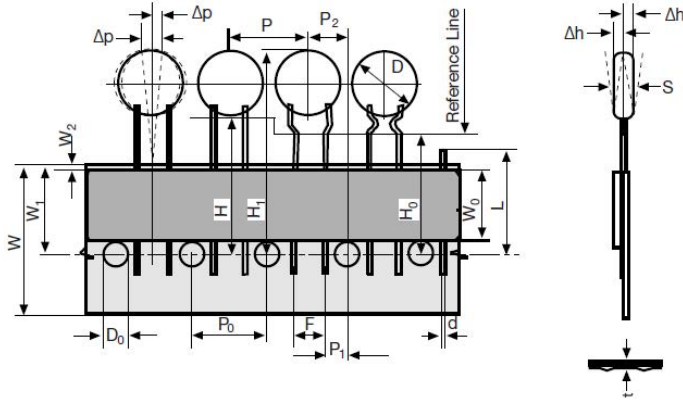

### TAPING P/T/U

COMPONENT PITCH 0.5 inch

LEAD SPACING 7.5 mm



### TAPING F

COMPONENT PITCH 1.0 inch

LEAD SPACING 5.0 mm, 7.5 mm, 10.0 mm, and 12.5 mm





**Table 2 – Ammo Pack Taping Specifications**

| Lead Style  |        | TAPING P          | TAPING T   | TAPING U | TAPING F                           |
|---|--------|-------------------|------------|----------|------------------------------------|
| Item  | Symbol | Dimensions(mm)    |            |          |                                    |
| Pitch of component  | P      | 12.7±1            |            |          | 25.4 ±1                            |
| Pitch of sprocket hole  | P0     | 12.7±0.3          |            |          | 12.7 ±0.3                          |
| Distance, hole to lead  | P1     | 3.85±0.7          |            |          | (0.5F) ±0.7                        |
| Distance, hole to center of component   | P2     | 6.35±1.3          |            |          | 12.7 ±1.3                          |
| Lead spacing  | F      | 5.0/7.5 +0.8/-0.2 |            |          | 5/7.5/10/12.5 ±0.8                 |
| Average deviation across tape   | Δh     | ±2.0 maximum      |            |          | ±3.0 maximum                       |
| Average deviation in direction of reeling   | Δp     | ±1.3 maximum      |            |          | ±1.3 maximum                       |
| Carrier tape width  | W      | 18.0 +1/-0.5      |            |          | 18.0 +1/-0.5                       |
| Hold-down tape width  | W0     | 6                 |            |          | 6                                  |
| Position of sprocket hole   | W1     | 9.0 +0.75/-0.5    |            |          | 9.0 +0.75/-0.5                     |
| Distance of hold-down tape  | W2     | 3.0 maximum       |            |          | 3.0 maximum                        |
| Distance between the abscissa and the bottom place of the component body (straight leads) | H      | 16.5 ±0.5         | 18.0 +2/-0 | 20 ±1    | 16.5 ±0.5<br>18.0 +2/-0<br>20.0 ±1 |
| Distance between the abscissa and the bottom place of the component body (kinked leads)   | H0     | 16.0 ±0.5         |            |          | 16.0 ±0.5                          |
| Length of cut leads   | L      | 11.0 maximum      |            |          | 11.0 maximum                       |
| Diameter of sprocket hole   | D0     | 4.0 ±0.2          |            |          | 4.0 ±0.2                           |
| Total tape thickness  | t      | 0.9 maximum       |            |          | 0.9 maximum                        |

<sup>1</sup> Prefromed (crimped) lead configurations include vertical kink, outside kink and inside kink. See "Lead Configurations" and "Ordering Information" sections of this document for further details.

<sup>2</sup> Also referred to as "lead length" in this document.

## Application Notes

### Storage and Operating Conditions

The insulating coating of these devices does not form an air and moisture-tight seal. Avoid exposure to moisture and do not use or store these devices in a corrosive atmosphere, especially where chloride gas, sulfide gas, acid, alkali, salt, or the like are present. Before cleaning, bonding or molding these devices, it is important to verify that your process does not affect product quality and performance. KEMET recommends testing and evaluating the performance of a cleaned, bonded or molded product prior to implementing and/or qualifying any of these processes. Store the capacitors where the temperature and relative humidity do not exceed 40 degrees centigrade and 70% respectively. For optimum solderability, capacitor stock should be used promptly, preferably within 6 months of receipt.

### Working Voltage

Application voltage ( $V_{p-p}$  or  $V_{o-p}$ ) must not exceed the voltage rating of the capacitor. Irregular voltages can be generated for a transient period of time when voltage is initially applied and/or removed from a circuit. It is important to choose a capacitor with a voltage rating greater than or equal to these irregular voltages.

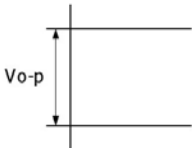
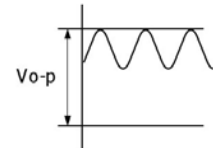
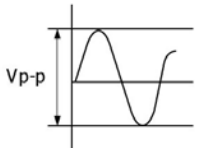
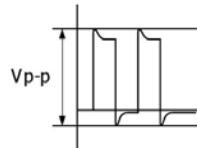
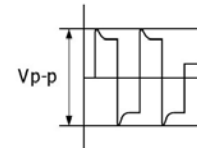
| Voltage                | DC Voltage  | DC+AC Voltage   | AC Voltage  | Pulse Voltage (1)   | Pulse Voltage (2)   |
|------------------------|---|---|---|---|---|
| Positional Measurement |  |  |  |  |  |

### Operating Temperature and Self-Generating Heat

The surface temperature of a capacitor should be kept below the upper limit of its rated operating temperature range. Be sure to take into account the heat generated by the capacitor itself. When the capacitor is used in a high-frequency current, pulse current or similar current, it may self-generate heat due to dielectric loss. Temperature rise due to self-generated heating should not exceed 20°C (while operated at an atmosphere temperature of 25°C).

### Handling - Vibration and Impact

Do not expose these devices or their leads to excessive shock or vibration during use.

**FAILURE TO FOLLOW THE ABOVE CAUTIONS MAY RESULT, WORST CASE, IN A SHORT CIRCUIT AND CAUSE FUMING OR PARTIAL DISPERSION WHEN THE PRODUCT IS USED.**

## KEMET Electronics Corporation Sales Offices

For a complete list of our global sales offices, please visit [www.kemet.com/sales](http://www.kemet.com/sales).

---

### Disclaimer

All product specifications, statements, information and data (collectively, the "Information") in this datasheet are subject to change. The customer is responsible for checking and verifying the extent to which the Information contained in this publication is applicable to an order at the time the order is placed. All Information given herein is believed to be accurate and reliable, but it is presented without guarantee, warranty, or responsibility of any kind, expressed or implied.

Statements of suitability for certain applications are based on KEMET Electronics Corporation's ("KEMET") knowledge of typical operating conditions for such applications, but are not intended to constitute – and KEMET specifically disclaims – any warranty concerning suitability for a specific customer application or use. The Information is intended for use only by customers who have the requisite experience and capability to determine the correct products for their application. Any technical advice inferred from this Information or otherwise provided by KEMET with reference to the use of KEMET's products is given gratis, and KEMET assumes no obligation or liability for the advice given or results obtained.

Although KEMET designs and manufactures its products to the most stringent quality and safety standards, given the current state of the art, isolated component failures may still occur. Accordingly, customer applications which require a high degree of reliability or safety should employ suitable designs or other safeguards (such as installation of protective circuitry or redundancies) in order to ensure that the failure of an electrical component does not result in a risk of personal injury or property damage.

Although all product-related warnings, cautions and notes must be observed, the customer should not assume that all safety measures are indicated or that other measures may not be required.

*KEMET is a registered trademark of KEMET Electronics Corporation.*



Компания «ЭлектроПласт» предлагает заключение долгосрочных отношений при поставках импортных электронных компонентов на взаимовыгодных условиях!

Наши преимущества:

- Оперативные поставки широкого спектра электронных компонентов отечественного и импортного производства напрямую от производителей и с крупнейших мировых складов;
- Поставка более 17-ти миллионов наименований электронных компонентов;
- Поставка сложных, дефицитных, либо снятых с производства позиций;
- Оперативные сроки поставки под заказ (от 5 рабочих дней);
- Экспресс доставка в любую точку России;
- Техническая поддержка проекта, помощь в подборе аналогов, поставка прототипов;
- Система менеджмента качества сертифицирована по Международному стандарту ISO 9001;
- Лицензия ФСБ на осуществление работ с использованием сведений, составляющих государственную тайну;
- Поставка специализированных компонентов (Xilinx, Altera, Analog Devices, Intersil, Interpoint, Microsemi, Aeroflex, Peregrine, Syfer, Eurofarad, Texas Instrument, Miteq, Cobham, E2V, MA-COM, Hittite, Mini-Circuits, General Dynamics и др.);

Помимо этого, одним из направлений компании «ЭлектроПласт» является направление «Источники питания». Мы предлагаем Вам помощь Конструкторского отдела:

- Подбор оптимального решения, техническое обоснование при выборе компонента;
- Подбор аналогов;
- Консультации по применению компонента;
- Поставка образцов и прототипов;
- Техническая поддержка проекта;
- Защита от снятия компонента с производства.



#### Как с нами связаться

**Телефон:** 8 (812) 309 58 32 (многоканальный)

**Факс:** 8 (812) 320-02-42

**Электронная почта:** [org@eplast1.ru](mailto:org@eplast1.ru)

**Адрес:** 198099, г. Санкт-Петербург, ул. Калинина, дом 2, корпус 4, литера А.