



## **2-line filters**

### **SIFI-G for enhanced insertion loss**

250 V DC/AC, 50/60 Hz, 3 ... 36 A

<b>Series/Type:</b>	<b>B84112G0000*</b>
Date:	2008-10-01
Version:	09

### Construction

- 2-line filter
- Metal case
- Polyurethane potting (UL 94 V-0)

### Features

- Easy to install
- Compact design
- Cost optimized construction
- Medical version with low leakage current
- ENEC10, UL and cUL approval



### Applications

- Switched-mode power supplies for
  - industrial electronics
  - telecom systems
  - data systems
- DC applications
- Medical engineering Type M

### Terminals

- Filters up to 16A tab connectors 6.3 x 0.8 mm
- Threaded studs M5 for filters from 20A to 36A

### Marking

- Marking on component:  
manufacturer's logo, ordering code, rated voltage, rated current,  
rated temperature, climatic category, date code
- Minimum marking on packaging: manufacturer's logo, ordering code,  
date code, quantity

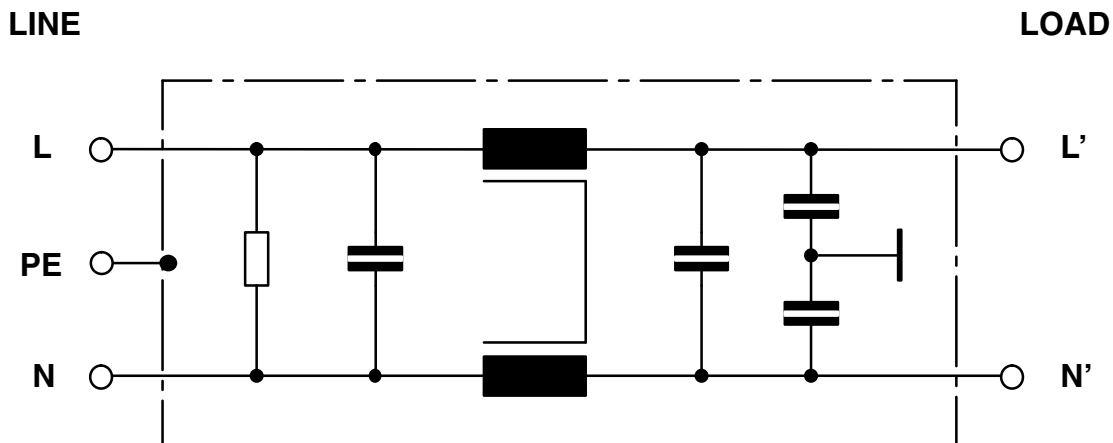

**Typical circuit diagram of B84112G0000B\* and B84112G0000G\***

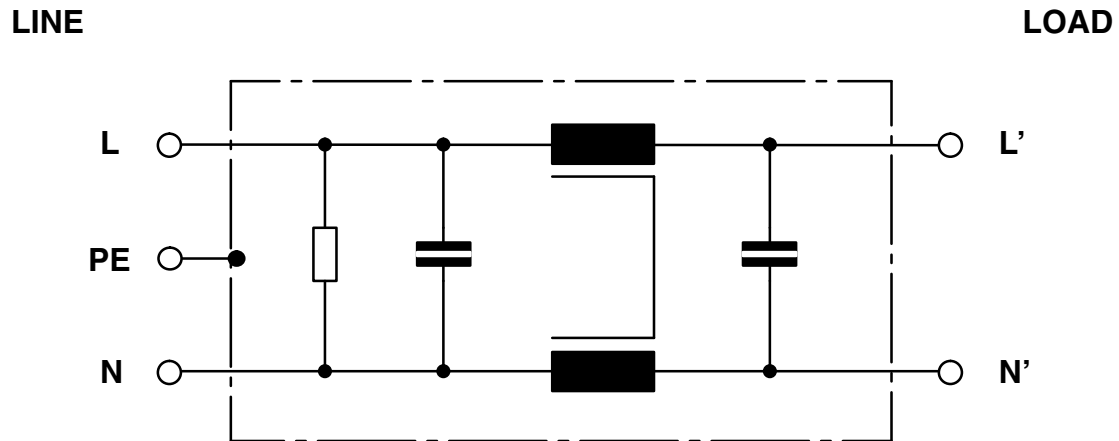
**Technical data and measuring conditions of B84112G0000B\* and B84112G0000G\***

Rated voltage	$U_R$	250	V DC/AC
Rated frequency	$f_R$	50/60	Hz
Test voltage line to line for 2 s	$U_{test}$	1770	V DC
Test voltage line to case for 2 s	$U_{test}$	2700	V DC
Leakage current	$I_{leak}$	At 230 V AC, 50 Hz	
Rated temperature	$T_R$	40	°C
Climatic category (IEC 60068-1)		25/100/21	



**Typical circuit diagram of B84112G0000M\* (for medical applications)**

**Technical data and measuring conditions of B84112G0000M\***

Rated voltage	$U_R$	250	V DC/AC
Rated frequency	$f_R$	50/60	Hz
Test voltage line to line for 2 s	$U_{test}$	1770	V DC
Test voltage line to case for 2 s	$U_{test}$	2500	V AC
Leakage current	$I_{leak}$	At 230 V AC, 50 Hz	
Rated temperature	$T_R$	40	°C
Climatic category (IEC 60068-1)		25/100/21	

**Characteristics and ordering codes of B84112G0000B\* and B84112G0000G\***

I <sub>R</sub>	C <sub>R</sub>	L <sub>R</sub>	I <sub>leak</sub>	Case style	Approx. weight	Ordering code	Approvals		
									
A		mH	mA		g				
3	2 x 0,22 µF (X2) 2 x 4700 pF (Y2)	2 x 10	< 0,5	1	200	B84112G0000B030	X	X	X
6	2 x 0,47 µF (X2) 2 x 4700 pF (Y2)	2 x 3,3	< 0,5	1	200	B84112G0000B060	X	X	X
10	2 x 0,68 µF (X2) 2 x 4700 pF (Y2)	2 x 1,8	< 0,5	1	200	B84112G0000B110	X	X	X
16	2 x 0,47 µF (X2) 2 x 4700 pF (Y2)	2 x 1,8	< 0,5	1	210	B84112G0000B116	X	X	X
20	2 x 1,0 µF (X2) 2 x 4700 pF (Y2)	2 x 1,8	< 0,5	2	440	B84112G0000G120	X	X	X
25	2 x 1,0 µF (X2) 2 x 4700 pF (Y2)	2 x 1,6	< 0,5	2	440	B84112G0000G125	X	X	X
36	2 x 1,5 µF (X2) 2 x 4700 pF (Y2)	2 x 0,8	< 0,5	2	470	B84112G0000G136	X	X	X

**Characteristics and ordering codes of B84112G0000M\***

I <sub>R</sub>	C <sub>R</sub>	L <sub>R</sub>	I <sub>leak</sub>	Case style	Approx. weight	Ordering code	Approvals		
									
A		mH	µA		g				
3	2 x 0,22 µF (X2)	2 x 10	< 2	1	200	B84112G0000M030	X	X	X
6	2 x 0,47 µF (X2)	2 x 3,3	< 2	1	200	B84112G0000M060	X	X	X
10	2 x 0,68 µF (X2)	2 x 1,8	< 2	1	200	B84112G0000M110	X	X	X
16	2 x 0,47 µF (X2)	2 x 1,8	< 2	1	210	B84112G0000M116	X	X	X
20	2 x 1,0 µF (X2)	2 x 1,8	< 2	2	440	B84112G0000M120	X	X	X
25	2 x 1,0 µF (X2)	2 x 1,6	< 2	2	440	B84112G0000M125	X	X	X
36	2 x 1,5 µF (X2)	2 x 0,8	< 2	2	470	B84112G0000M136	X	X	X

X = approval granted

**Dimensional drawing** (case style 1)  
 B84112G0000B030...B84112G0000B116  
 B84112G0000M030...B84112G0000M116

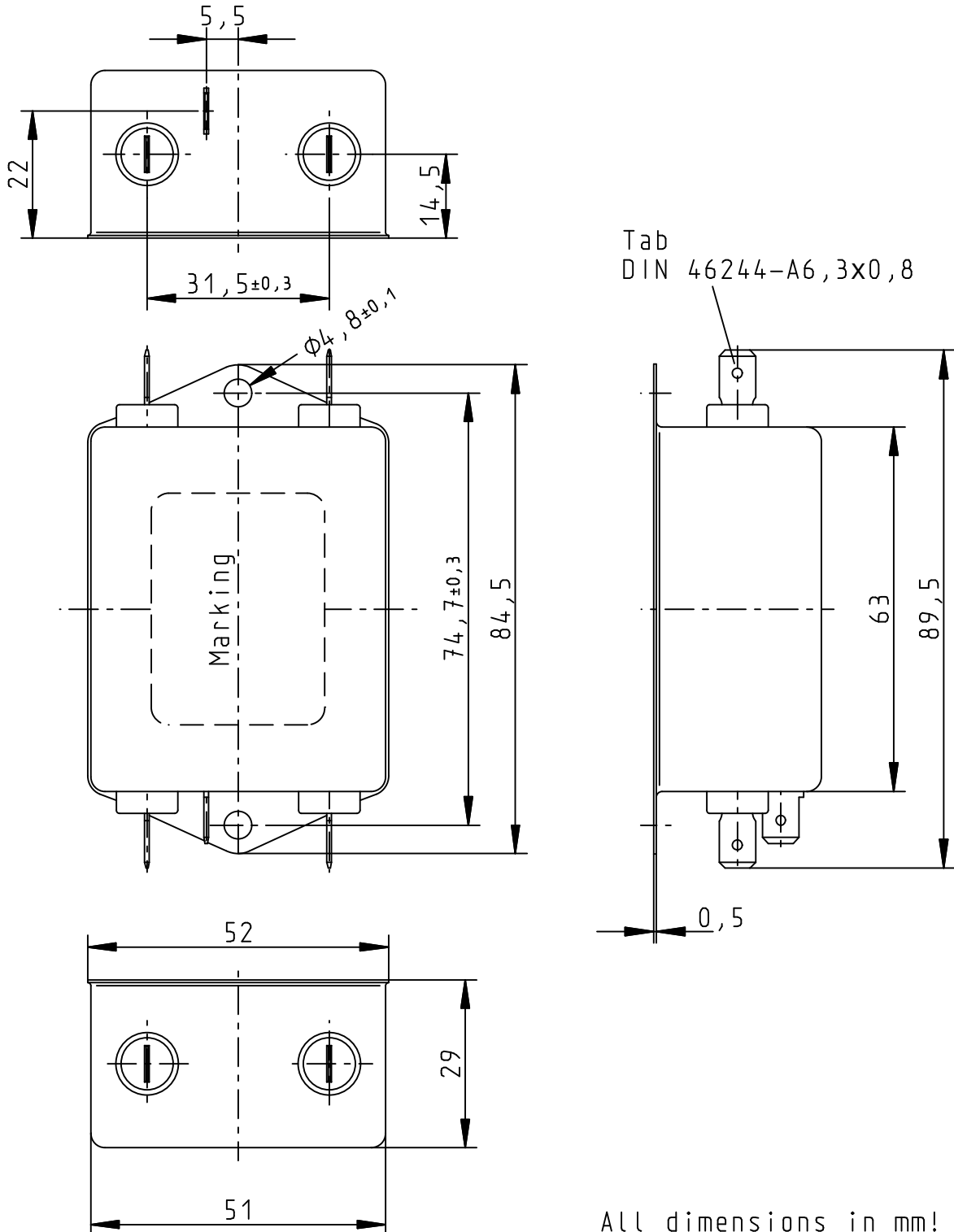

All dimensions in mm!

**Dimensional drawing** (case style 2)  
 B84112G0000G120...B84112G0000G136  
 B84112G0000M120...B84112G0000M136

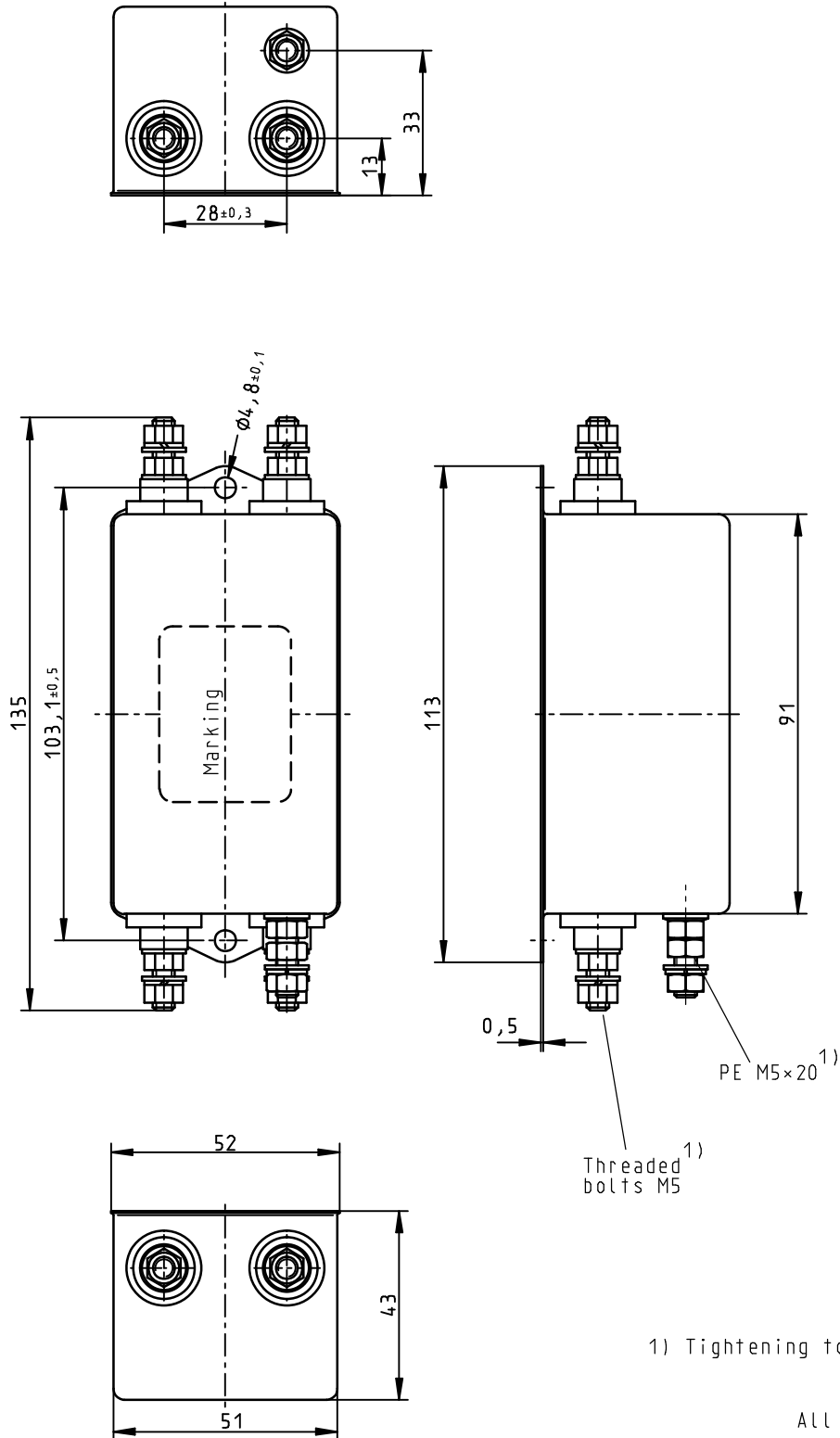

1) Tightening torque 2,6...3,0 Nm!

All dimensions in mm!

SIFI-G for enhanced insertion loss

Insertion loss (typical values at  $Z = 50 \Omega$ )

- unsymmetrical, adjacent branches terminated
- .- common mode, all branches in parallel (asymmetrical)
- - - differential mode (symmetrical)

B84112G0000B030

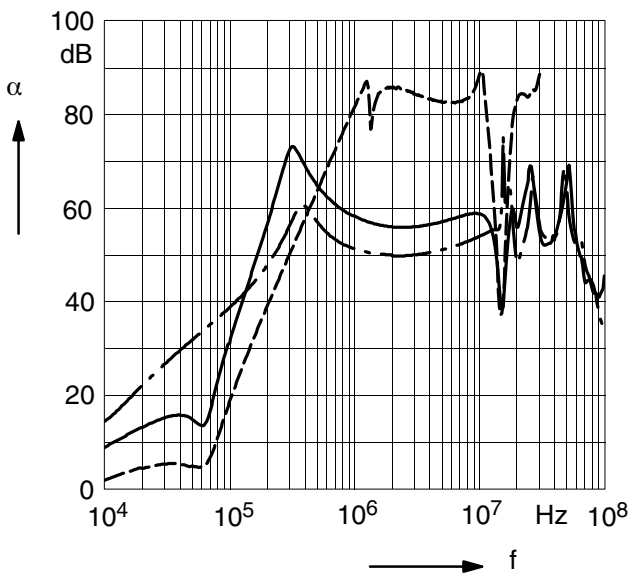

B84112G0000B060

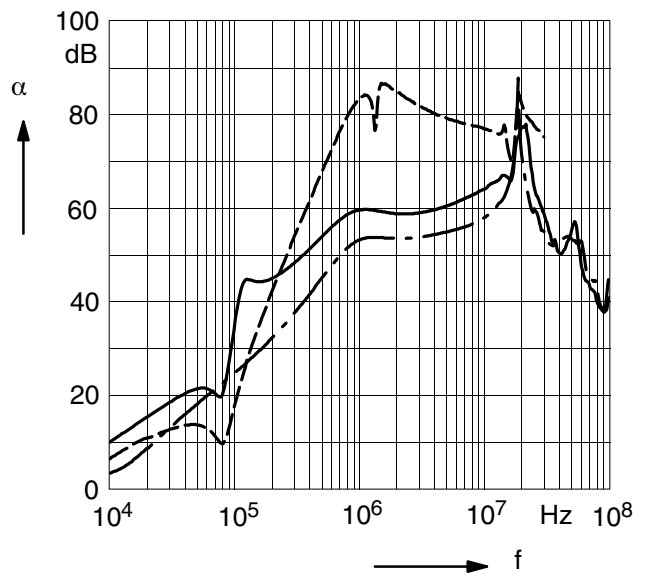

B84112G0000B110

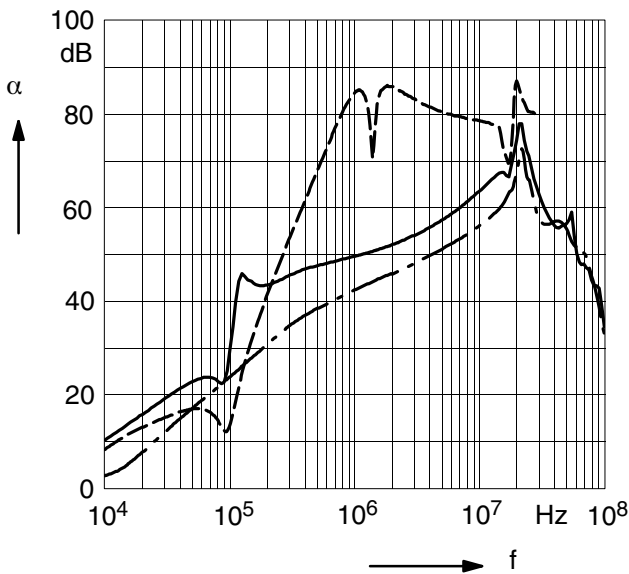

B84112G0000B116

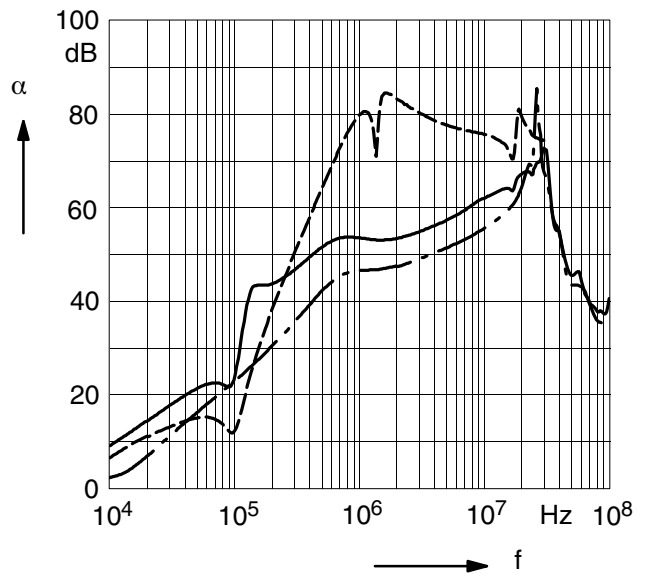



SIFI-G for enhanced insertion loss

Insertion loss (typical values at  $Z = 50 \Omega$ )

- unsymmetrical, adjacent branches terminated
- · - common mode, all branches in parallel (asymmetrical)
- - - differential mode (symmetrical)

B84112G0000G120

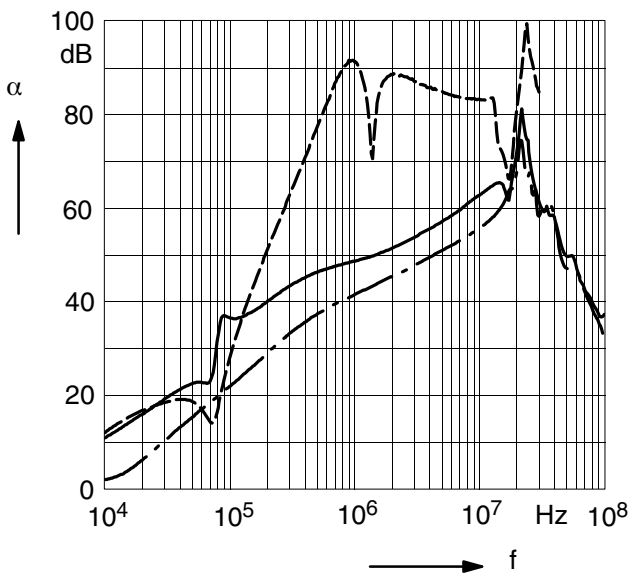

B84112G0000G125

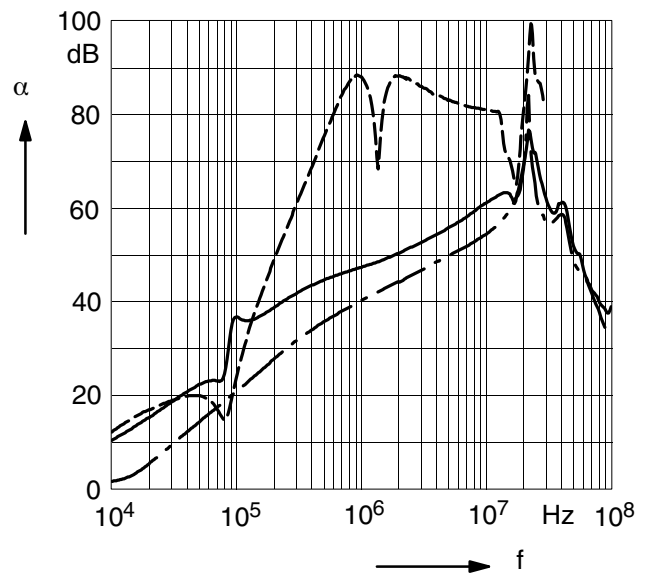

B84112G0000G136

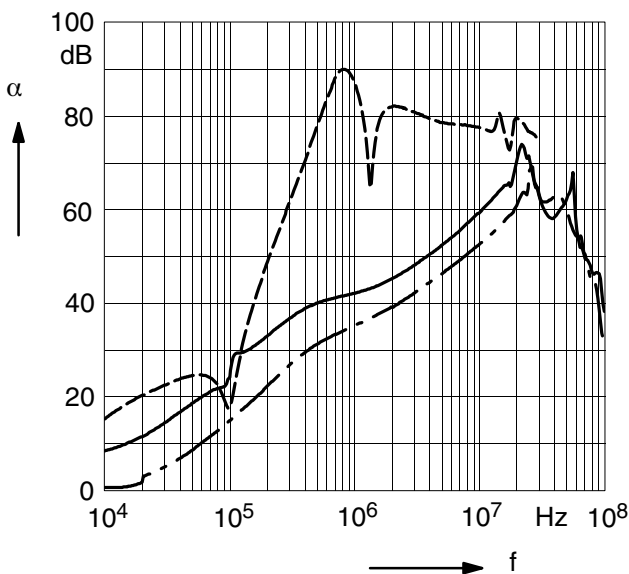

SIFI-G for enhanced insertion loss

Insertion loss (typical values at  $Z = 50 \Omega$ )

- unsymmetrical, adjacent branches terminated
- .- common mode, all branches in parallel (asymmetrical)
- - - differential mode (symmetrical)

B84112G0000M030

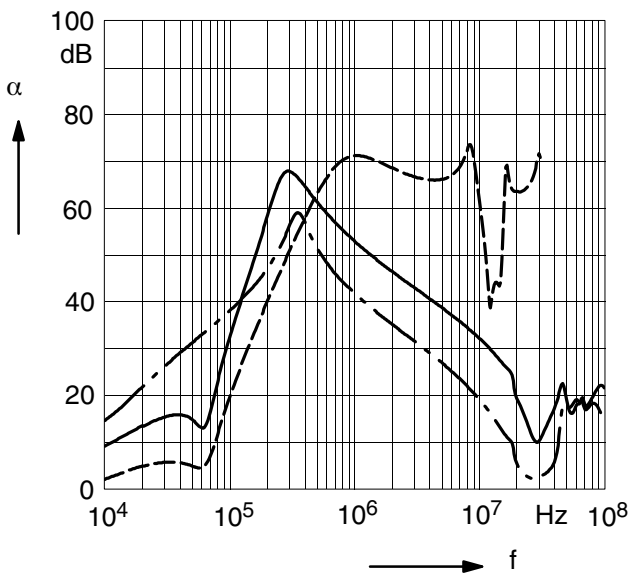

B84112G0000M060

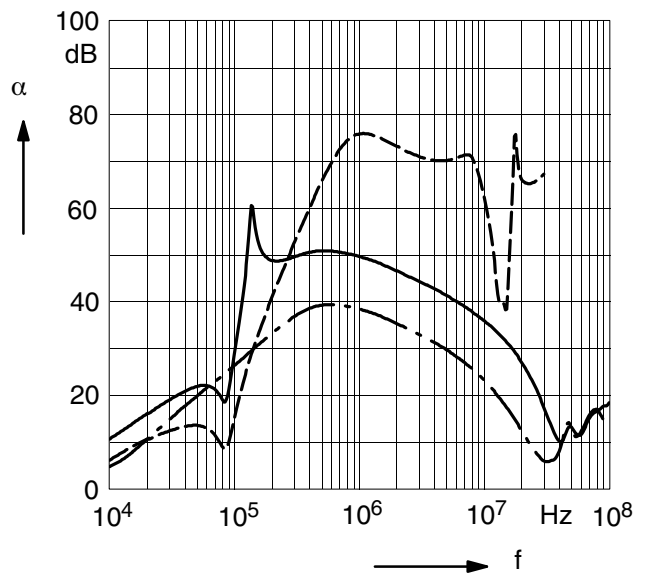

B84112G0000M110

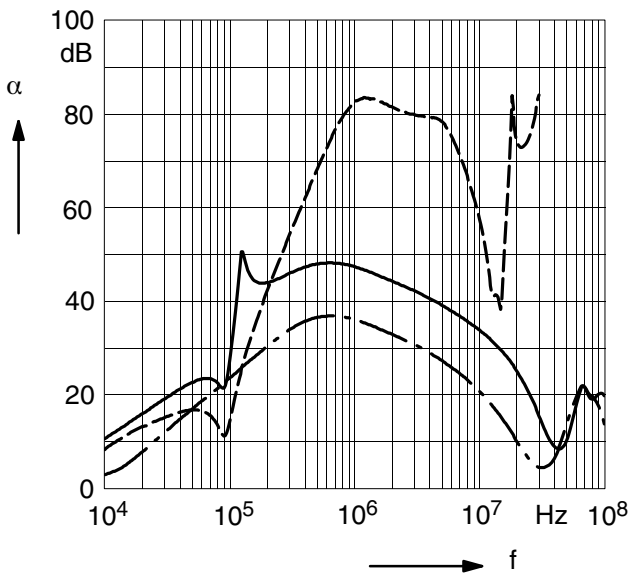

B84112G0000M116

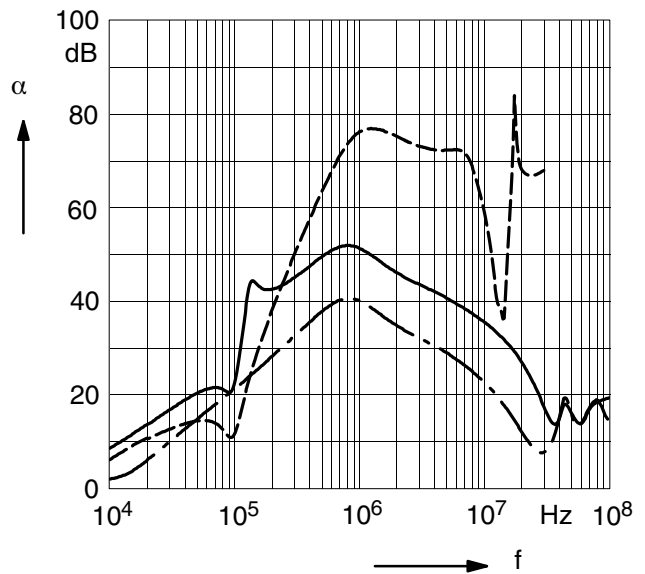

SIFI-G for enhanced insertion loss

Insertion loss (typical values at  $Z = 50 \Omega$ )

- unsymmetrical, adjacent branches terminated
- .- common mode, all branches in parallel (asymmetrical)
- - - differential mode (symmetrical)

B84112G0000M120

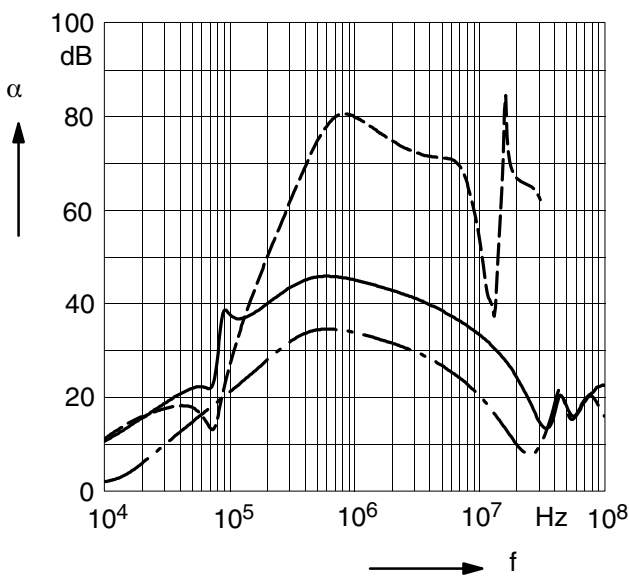

B84112G0000M125

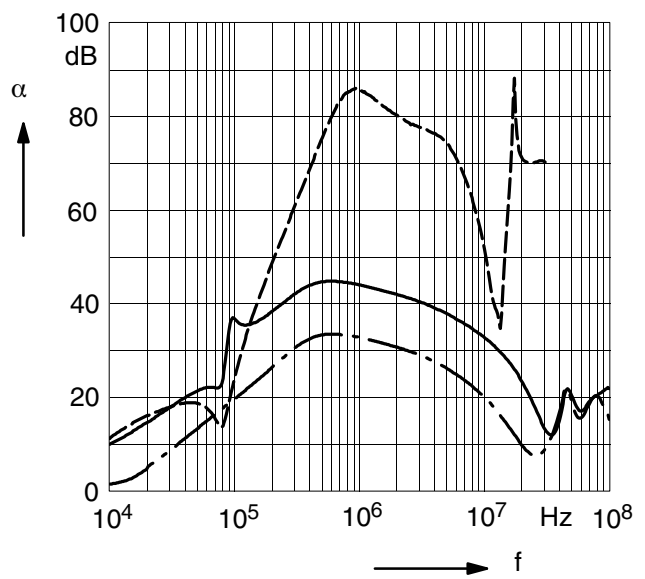

B84112G0000M136

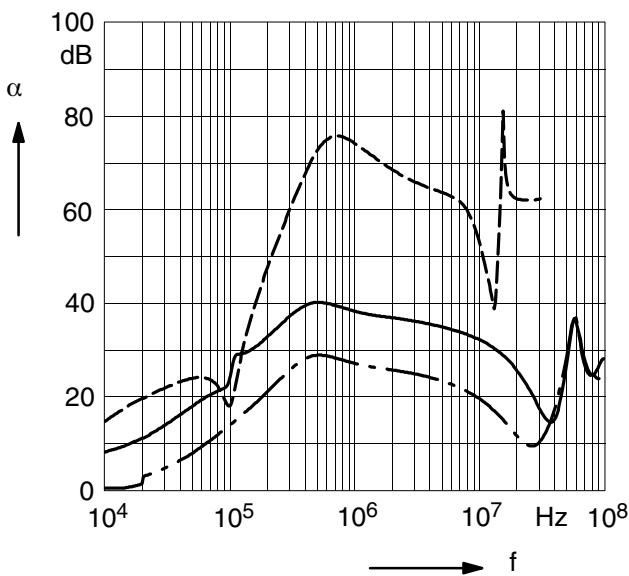

### Caution and warnings

- Please note the advices in our data book “EMC Filters” (latest edition); attention should be paid to the chapter “General safety notes”.
- It shall be ensured that only qualified persons (electricity specialists) are engaged on work such as planning, assembly, installation, operation, repair and maintenance. They must be provided with the corresponding documentation.
- Danger of electric shock. EMC filters contain components that store an electric charge. Dangerous voltages can continue to exist at the filter terminals for longer than five minutes even after the power has been switched off.
- The protective earth connections shall be the first to be made when the EMC filter is installed and the last to be disconnected. Depending on the magnitude of the leakage currents, the particular specifications for making the protective–earth connection must be observed.
- Impermissible overloading of the EMC filter, such as with circuits able to cause resonances, impermissible voltages at higher frequencies etc. can lead to bodily injury and death as well as cause substantial material damages (e.g. destruction of the filter housing).
- EMC filters must be protected in the application against impermissible exceeding of the rated currents by overcurrent protective.
- In case of leakage currents  $> 3.5 \text{ mA}$  you shall mount the PE conductor stationary with the required cross section before beginning of operation and save it against disconnecting. For leakage currents  $I_L^4) < 10 \text{ mA}$  the PE conductor must have a KU value <sup>3)</sup> of 4.5; for leakage currents  $I_L \geq 10 \text{ mA}$  the PE conductor must have a KU value of 6.

3) The KU value (symbol KU) is a classification parameter of safety–referred failure types designed to ensure protection against hazardous body currents and excessive heating.

A value of KU = 4.5 with respect to interruptions is attained:

– with a permanently connected protective earth circuit  $\geq 1.5 \text{ mm}^2$

– with a protective earth circuit  $\geq 2.5 \text{ mm}^2$  connected via shroud connectors (IEC 60309–2).

KU = 6 with respect to interruptions is achieved for fixed–connection lines  $\geq 10 \text{ mm}^2$  where the type of connection and line layout correspond to the requirements for PEN conductors as specified in relevant standards.

4)  $I_L$  = leakage current let–go

## Important notes

The following applies to all products named in this publication:

1. Some parts of this publication contain **statements about the suitability of our products for certain areas of application**. These statements are based on our knowledge of typical requirements that are often placed on our products in the areas of application concerned. We nevertheless expressly point out **that such statement cannot be regarded as binding statements about the suitability of our products for a particular customer application**. As a rule, EPCOS is either unfamiliar with individual customer applications or less familiar with them than the customers themselves. For these reasons, it is always ultimately incumbent on the customer to check and decide whether an EPCOS product with the properties described in the product specification is suitable for use in a particular customer application.
2. We also point out that **in individual cases, a malfunction of electronic components or failure before end of their usual service life time cannot be completely ruled out in the current state of the art, even if they are operated as specified**. In customer applications requiring a very high level of operational safety and especially in customer applications in which the malfunction or failure of a passive electronic component could endanger human life or health (e.g. in accident prevention or life-saving systems), it must therefore be ensured by means of suitable design of the customer application or other action taken by the customer (e.g. installation of protective circuitry or redundancy) that no injury or damage is sustained by third parties in the event of malfunction or failure of a passive electronic component.
3. **The warnings, cautions and product-specific notes must be observed.**
4. In order to satisfy certain technical requirements, **some of the products described in this publication may contain substances subject to restrictions in certain jurisdictions (e.g. because they are classed as hazardous)**. Useful information on this will be found in our Material Data Sheets on the Internet ([www.epcos.com/material](http://www.epcos.com/material)). Should you have any more detailed questions, please contact our sales offices.
5. We constantly strive to improve our products. Consequently, **the products described in this publication may change from time to time**. The same is true of the corresponding product specifications. Please check therefore to what extent product descriptions and specifications contained in this publication are still applicable before or when you place an order. We also **reserve the right to discontinue production and delivery of products**. Consequently, we cannot guarantee that all products named in this publication will always be available. The aforementioned does not apply in the case of individual agreements deviating from the foregoing for customer-specific products.
6. Unless otherwise agreed in individual contracts, **all orders subject to the current version of the "General Terms of Delivery for Products and Services in the Electrical Industry" published by the the German Electrical and Electronics Industry Association (ZVEI)**.
7. The trade names EPCOS, BAOKE, Alu-X, CeraDiode, CSSP, CTVS, DSSP, MiniBlue, MKK, MLSC, MotorCAP, PCC, PhaseCap, PhaseMod, SIFERRIT, SIFI, SIKOREL, SilverCap, SIMDAD, SIMID, SineFormer, SIOV, SIP5D, SIP5K, ThermoFuse, WindCap are **trademarks registered or pending** in Europe and in other countries. Further information will be found on the Internet at [www.epcos.com/trademarks](http://www.epcos.com/trademarks).

# Mouser Electronics

Authorized Distributor

Click to View Pricing, Inventory, Delivery & Lifecycle Information:

## EPCOS:

[B84112GB110](#) [B84112GB116](#) [B84112GB30](#) [B84112GB60](#) [B84112GG120](#) [B84112GG125](#) [B84112GG136](#)  
[B84112G0000M030](#) [B84112G0000M060](#) [B84112G0000M110](#) [B84112G0000M116](#)



Компания «ЭлектроПласт» предлагает заключение долгосрочных отношений при поставках импортных электронных компонентов на взаимовыгодных условиях!

Наши преимущества:

- Оперативные поставки широкого спектра электронных компонентов отечественного и импортного производства напрямую от производителей и с крупнейших мировых складов;
- Поставка более 17-ти миллионов наименований электронных компонентов;
- Поставка сложных, дефицитных, либо снятых с производства позиций;
- Оперативные сроки поставки под заказ (от 5 рабочих дней);
- Экспресс доставка в любую точку России;
- Техническая поддержка проекта, помощь в подборе аналогов, поставка прототипов;
- Система менеджмента качества сертифицирована по Международному стандарту ISO 9001;
- Лицензия ФСБ на осуществление работ с использованием сведений, составляющих государственную тайну;
- Поставка специализированных компонентов (Xilinx, Altera, Analog Devices, Intersil, Interpoint, Microsemi, Aeroflex, Peregrine, Syfer, Eurofarad, Texas Instrument, Miteq, Cobham, E2V, MA-COM, Hittite, Mini-Circuits, General Dynamics и др.);

Помимо этого, одним из направлений компании «ЭлектроПласт» является направление «Источники питания». Мы предлагаем Вам помощь Конструкторского отдела:

- Подбор оптимального решения, техническое обоснование при выборе компонента;
- Подбор аналогов;
- Консультации по применению компонента;
- Поставка образцов и прототипов;
- Техническая поддержка проекта;
- Защита от снятия компонента с производства.



#### Как с нами связаться

**Телефон:** 8 (812) 309 58 32 (многоканальный)

**Факс:** 8 (812) 320-02-42

**Электронная почта:** [org@eplast1.ru](mailto:org@eplast1.ru)

**Адрес:** 198099, г. Санкт-Петербург, ул. Калинина, дом 2, корпус 4, литера А.