

| | |
|------------------------|---|
| Title | <i>Reference Design Report for a Dual Output 20 W Power Supply Using InnoSwitch™-EP INN2605K</i> |
| Specification | 85 VAC – 264 VAC Input; 12 V, 1.5 A and 5 V, 0.5 A Outputs |
| Application | Embedded Power Supply |
| Author | Applications Engineering Department |
| Document Number | RDR-469 |
| Date | February 4, 2016 |
| Revision | 1.3 |

Summary and Features

- InnoSwitch-EP - industry first AC/DC ICs with isolated, safety rated integrated feedback
- Built in synchronous rectification for >87% efficiency
- All the benefits of secondary side control with the simplicity of primary side regulation
 - Insensitive to transformer variation
 - Extremely fast transient response independent of load timing
- Meets output cross regulation requirements without linear regulators
- Primary sensed output overvoltage protection (OVP) eliminates optocoupler for fault protection
- Accurate thermal protection with hysteretic shutdown
- Input voltage monitor with accurate brown-in/brown-out and overvoltage protection

PATENT INFORMATION

The products and applications illustrated herein (including transformer construction and circuits external to the products) may be covered by one or more U.S. and foreign patents, or potentially by pending U.S. and foreign patent applications assigned to Power Integrations. A complete list of Power Integrations' patents may be found at www.powerint.com. Power Integrations grants its customers a license under certain patent rights as set forth at <http://www.powerint.com/ip.htm>.

Power Integrations

5245 Hellyer Avenue, San Jose, CA 95138 USA.
Tel: +1 408 414 9200 Fax: +1 408 414 9201
www.power.com

Table of Contents

| | | |
|--------|---|----|
| 1 | Introduction | 4 |
| 2 | Power Supply Specification | 6 |
| 3 | Schematic | 7 |
| 4 | Circuit Description | 8 |
| 4.1 | Input EMI Filtering | 8 |
| 4.2 | InnoSwitch-EP Primary | 8 |
| 4.3 | InnoSwitch-EP IC Secondary | 8 |
| 5 | PCB Layout | 10 |
| 6 | Bill of Materials | 12 |
| 7 | Transformer (T1) Specification | 14 |
| 7.1 | Electrical Diagram | 14 |
| 7.2 | Electrical Specifications | 14 |
| 7.3 | Material List | 14 |
| 7.4 | Transformer Build Diagram | 15 |
| 7.5 | Winding Instructions | 15 |
| 7.6 | Winding Illustrations | 16 |
| 8 | 15 mH Common Mode Choke (L1) Specification | 21 |
| 8.1 | Electrical Diagram | 21 |
| 8.2 | Electrical Specifications | 21 |
| 8.3 | Material List | 21 |
| 8.4 | Winding Instructions | 21 |
| 8.5 | Illustrations | 21 |
| 9 | 90 μ H Common Mode Choke (L2) Specification | 22 |
| 9.1 | Electrical Diagram | 22 |
| 9.2 | Electrical Specifications | 22 |
| 9.3 | Material List | 22 |
| 9.4 | Illustrations | 22 |
| 10 | Transformer Design Spreadsheet | 23 |
| 11 | Performance Data | 26 |
| 11.1 | Full Load Efficiency vs. Line | 26 |
| 11.2 | Efficiency vs. Load (0 A – 1.5 A on 12 V, Full Load on 5 V) | 27 |
| 11.3 | Efficiency vs. Load (0 A – 1.5 A on 12 V, No-Load on 5 V) | 28 |
| 11.4 | No-Load Input Power | 29 |
| 11.5 | 5 V Output Power with Low Input Power (No-Load on 12 V) | 30 |
| 11.6 | Line and Load Regulation | 31 |
| 11.6.1 | Line Regulation (Full load) | 31 |
| 11.6.2 | Cross Load Regulation | 32 |
| 12 | Thermal Performance | 36 |
| 12.1 | 85 VAC | 36 |
| 12.2 | 110 VAC | 37 |
| 12.3 | 230 VAC | 38 |
| 12.4 | 265 VAC | 39 |



| | | |
|--------|--|----|
| 13 | Waveforms | 40 |
| 13.1 | Load Transient Response | 40 |
| 13.1.1 | 50% 12 V Load Transient | 40 |
| 13.2 | Switching Waveforms..... | 41 |
| 13.2.1 | InnoSwitch-EP Waveforms..... | 41 |
| 13.2.2 | InnoSwitch-EP Drain Voltage and Current Waveforms During Start-up and Shorted Output | 41 |
| 13.2.3 | SR FET Waveforms | 42 |
| 13.2.4 | Output Voltage and Current Waveforms During Start-Up | 43 |
| 13.2.5 | Output Voltage and Current Waveform with Shorted Output (12 V)..... | 44 |
| 13.2.6 | Output Voltage and Current Waveform with Open Feedback Loop..... | 45 |
| 13.3 | Output Ripple Measurements..... | 46 |
| 13.3.1 | Ripple Measurement Technique | 46 |
| 13.3.2 | Ripple Voltage Waveforms | 47 |
| 13.4 | Line Undervoltage and Overvoltage (DC Input)..... | 48 |
| 14 | EMI..... | 49 |
| 14.1 | Conductive EMI | 49 |
| 14.1.1 | Floating Output (QP / AV)..... | 49 |
| 14.1.2 | Earth Grounded Output (QP / AV) | 51 |
| 14.2 | Radiated EMI..... | 53 |
| 14.2.1 | Floating Output..... | 53 |
| 14.2.2 | Earth Grounded Output | 54 |
| 15 | Lighting Surge Test..... | 55 |
| 15.1 | Differential Mode Test..... | 55 |
| 15.2 | Common Mode Test..... | 55 |
| 16 | Revision History | 56 |

Important Note:

Although this board is designed to satisfy safety isolation requirements, the engineering prototype has not been agency approved. Therefore, all testing should be performed using an isolation transformer to provide the AC input to the prototype board.

1 Introduction

This document is an engineering report describing a 1.5 A, 12 V and 0.5 A, 5 V dual output embedded power supply utilizing INN2605K from the InnoSwitch-EP family of ICs.

This design shows the high power density and efficiency that is possible due to the high level of integration while still providing exceptional performance.

The document contains the power supply specification, schematic, bill of materials, transformer documentation, printed circuit layout, and performance data.

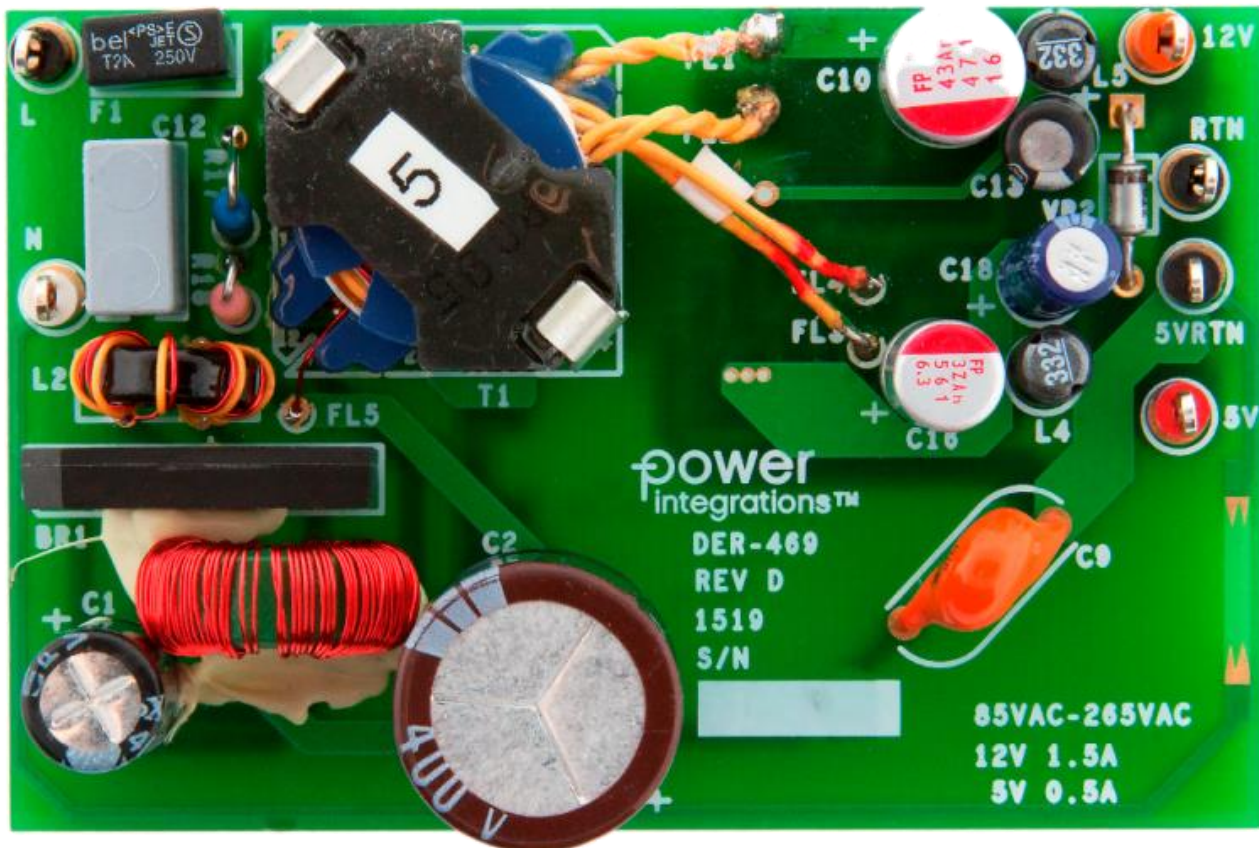

Figure 1 – Populated Circuit Board Photograph, Top.

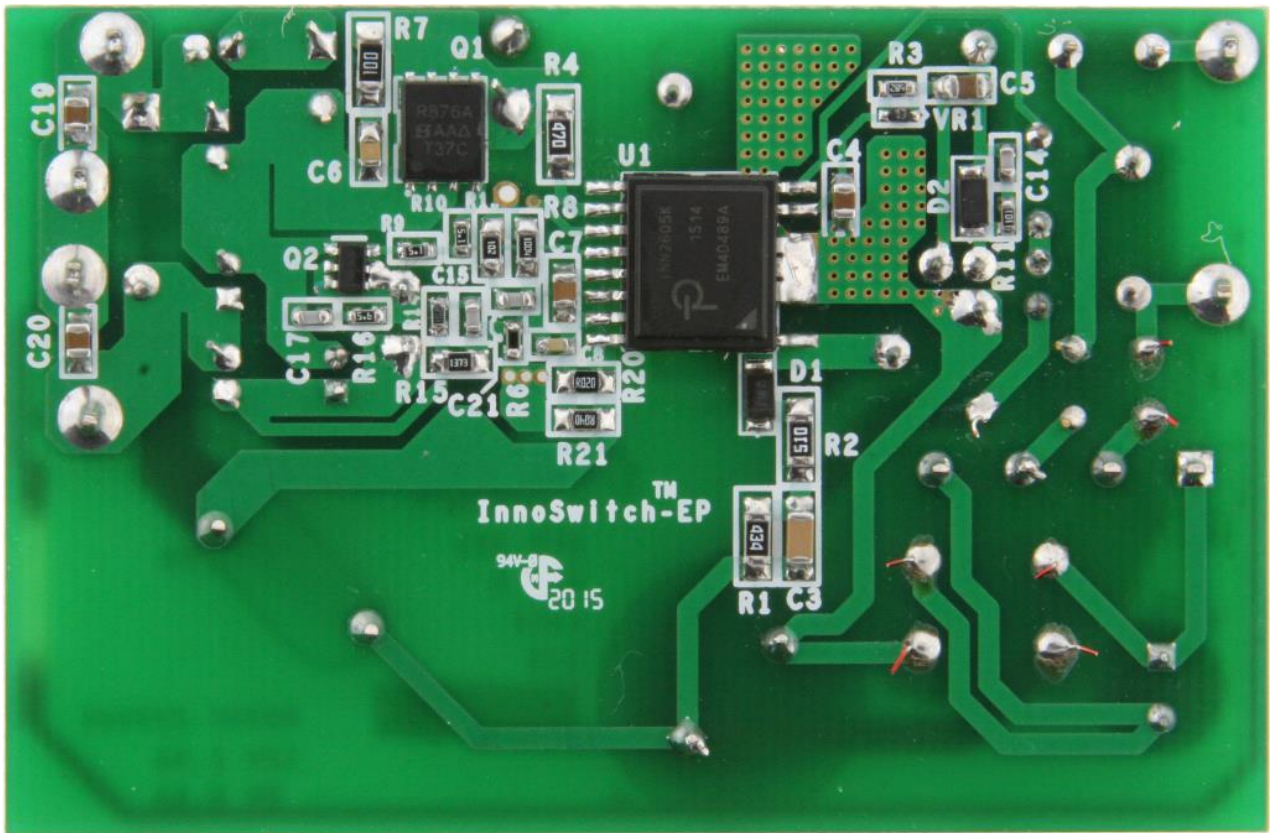

Figure 2 – Populated Circuit Board Photograph, Bottom.

2 Power Supply Specification

The table below represents the minimum acceptable performance of the design. Actual performance is listed in the results section.

| Description | Symbol | Min | Typ | Max | Units | Comment |
|--------------------------------|---------------|------|-------|------|-------|--|
| Input | | | | | | |
| Voltage | V_{IN} | 85 | | 265 | VAC | 3 Wire Input |
| Frequency | f_{LINE} | 47 | 50/60 | 64 | Hz | |
| Output | | | | | | |
| Output Voltage 1 | V_{OUT1} | 4.75 | 5 | 5.25 | V | ±5 % 20 MHz Bandwidth |
| Output Ripple Voltage 1 | $V_{RIPPLE1}$ | | | 50 | mV | |
| Output Current 1 | I_{OUT1} | 0 | | 0.5 | A | ±15 %, (±10 % with 0.1 A Min Load on 12 V) 20 MHz Bandwidth |
| Output Voltage 2 | V_{OUT2} | 10.2 | 12 | 13.8 | V | |
| Output Ripple Voltage 2 | $V_{RIPPLE2}$ | | | 150 | mV | |
| Output Current 2 | I_{OUT2} | 0 | | 1.5 | A | |
| Total Output Power | | | | | | |
| Continuous Output Power | P_{OUT} | | 21 | | W | |
| Efficiency | | | | | | |
| Full Load | η | 88 | | | % | Measured at 110 / 230 VAC, P_{OUT} 25 °C V_{IN} at 230 VAC |
| No Load Input Power | | | | 30 | mW | |
| Environmental | | | | | | |
| Conducted EMI | | | | | | Meets CISPR22B / EN55022B Designed to meet IEC950, UL1950 Class II |
| Safety | | | | | | |
| Surge Differential | | 1 | | | kV | 1.2/50 μ s surge, IEC 1000-4-5, Series Impedance: Differential Mode: 2 Ω 100 kHz Ring Wave, 12 Ω Common Mode |
| Surge Common mode Ring Wave | | 6 | | | kV | |
| Ambient Temperature | T_{AMB} | 0 | | 40 | °C | Free Convection, Sea Level |

3 Schematic

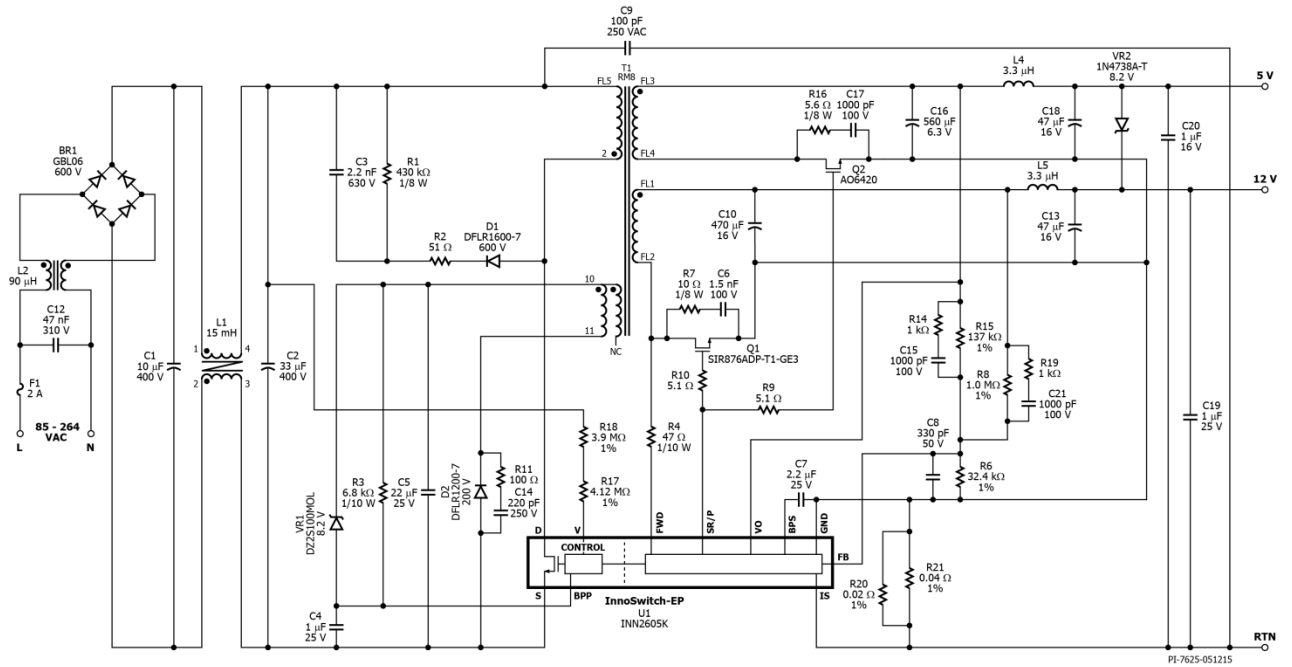

Figure 3 – Schematic.



4 Circuit Description

4.1 *Input EMI Filtering*

Fuse F1 isolates the circuit and provides protection from component failure and the common mode chokes L1 and L2 with capacitors, C9 and C12, provides attenuation for EMI. Bridge rectifier BR1 rectifies the AC line voltage and provides a full wave rectified DC across the filter consisting of C1 and C2. There is no need to use an inrush current limiter in the circuit with the high peak forward surge current rated bridge rectifier, GBL06. The differential inductance of common mode choke L1 with capacitors C1 and C2 provide differential noise filtering.

4.2 *InnoSwitch-EP Primary*

One side of the transformer primary is connected to the rectified DC bus, the other is connected to the integrated 725 V power MOSFET inside the InnoSwitch-EP IC (U1).

A low cost RCD clamp formed by D1, R1, R2, and C3 limits the peak drain voltage due to the effects of transformer leakage reactance and output trace inductance.

The IC is self-starting, using an internal high-voltage current source to charge the BPP pin capacitor, C4, when AC is first applied. During normal operation the primary side block is powered from an auxiliary winding on the transformer. The output of this is configured as a flyback winding which is rectified and filtered using diode D2 and capacitor C5, and fed in the BPP pin via a current limiting resistor R3. Radiated EMI caused by resonant ringing across diode D2 is reduced via snubber components R11 and C14. The primary side overvoltage protection is obtained using Zener diode VR1. In the event of overvoltage at output, the increased voltage at the output of the bias winding cause the Zener diode VR1 to conduct and triggers the OVP latch in the primary side controller of the InnoSwitch-EP IC.

Resistor R17 and R18 provide line voltage sensing and provide a current to U1, which is proportional to the DC voltage across capacitor C2. At approximately 100 V DC, the current through these resistors exceeds the line under-voltage threshold, which results in enabling of U1. At approximately 460 V DC, the current through these resistors exceeds the line over-voltage threshold, which results in disabling of U1.

4.3 *InnoSwitch-EP IC Secondary*

The secondary side of the InnoSwitch-EP provides output voltage, output current sensing and drive to a MOSFET providing synchronous rectification.

Output rectification for the 5 V output is provided by SR FET Q2. Very low ESR capacitor C16 provides filtering, and inductor L4 and capacitor C18 form a second stage filter that significantly attenuates the high frequency ripple and noise at the 5 V output.



Output rectification for the 12 V output is provided by SR FET Q1. Very low ESR capacitors C10 provides filtering, and Inductor L5 and capacitor C13 form a second stage filter that significantly attenuates the high frequency ripple and noise at the 12 V output. C19 and C20 capacitors reduce the radiation EMI noise.

RC snubber networks comprising R16 and C17 for Q2, R7 and C6 for Q1 damp high frequency ringing across SR FETs, which results from leakage inductance of the transformer windings and the secondary trace inductances.

The gates of Q1 and Q2 are turned on based on the winding voltage sensed via R4 and the FWD pin of the IC. In continuous conduction mode operation, the power MOSFET is turned off just prior to the secondary side controller commanding a new switching cycle from the primary. In discontinuous mode the MOSFET is turned off when the voltage drop across the MOSFET falls below a threshold ($V_{SR(TH)}$). Secondary side control of the primary side MOSFET ensure that it is never on simultaneously with the synchronous rectification MOSFET. The MOSFET drive signal is output on the SR/P pin.

The secondary side of the IC is self-powered from either the secondary winding forward voltage or the output voltage. The output voltage powers the device, fed into the VO pin and charges the decoupling capacitor C7 via R4 and an internal regulator. The unit enters auto-restart when the sensed output voltage is lower than 3 V.

Resistor R8, R15 and R6 form a voltage divider network that senses the output voltage from both outputs for better cross-regulation. Zener diode VR2 improves the cross regulation when only the 5 V output is loaded, which results in the 12 V output operating at the higher end of the specification. The InnoSwitch-EP IC has an internal reference of 1.265 V. Feedback compensation networks comprising capacitors C15, C21 and resistors R14, R19 reduce the output ripple voltage. Capacitor C8 provides decoupling from high frequency noise affecting power supply operation. Total output current is sensed by R20 and R21 with a threshold of approximately 33 mV to reduce losses. Once the current sense threshold across these resistors is exceeded, the device adjusts the number of switch pulses to maintain a fixed output current

5 PCB Layout

PCB copper thickness is 2 oz (2.8 mils / 70 μm) unless otherwise stated

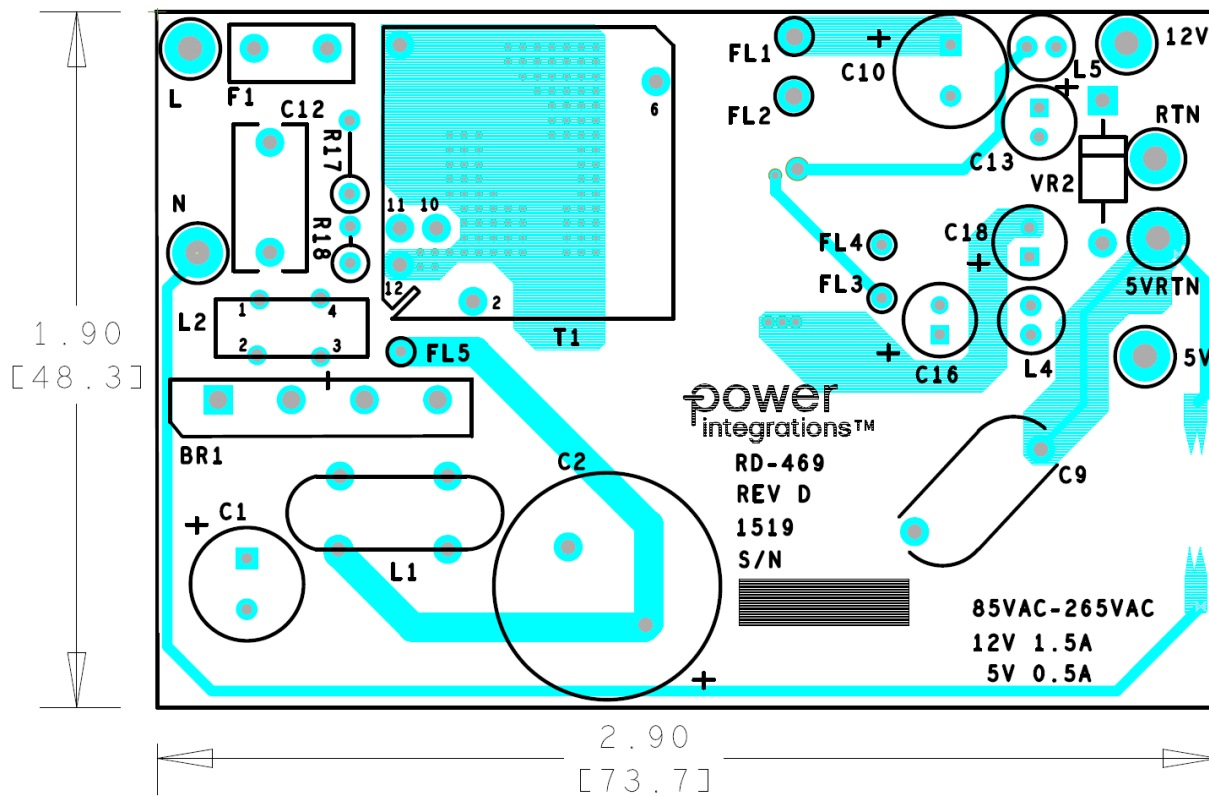

Figure 4 – Printed Circuit Layout, Top.

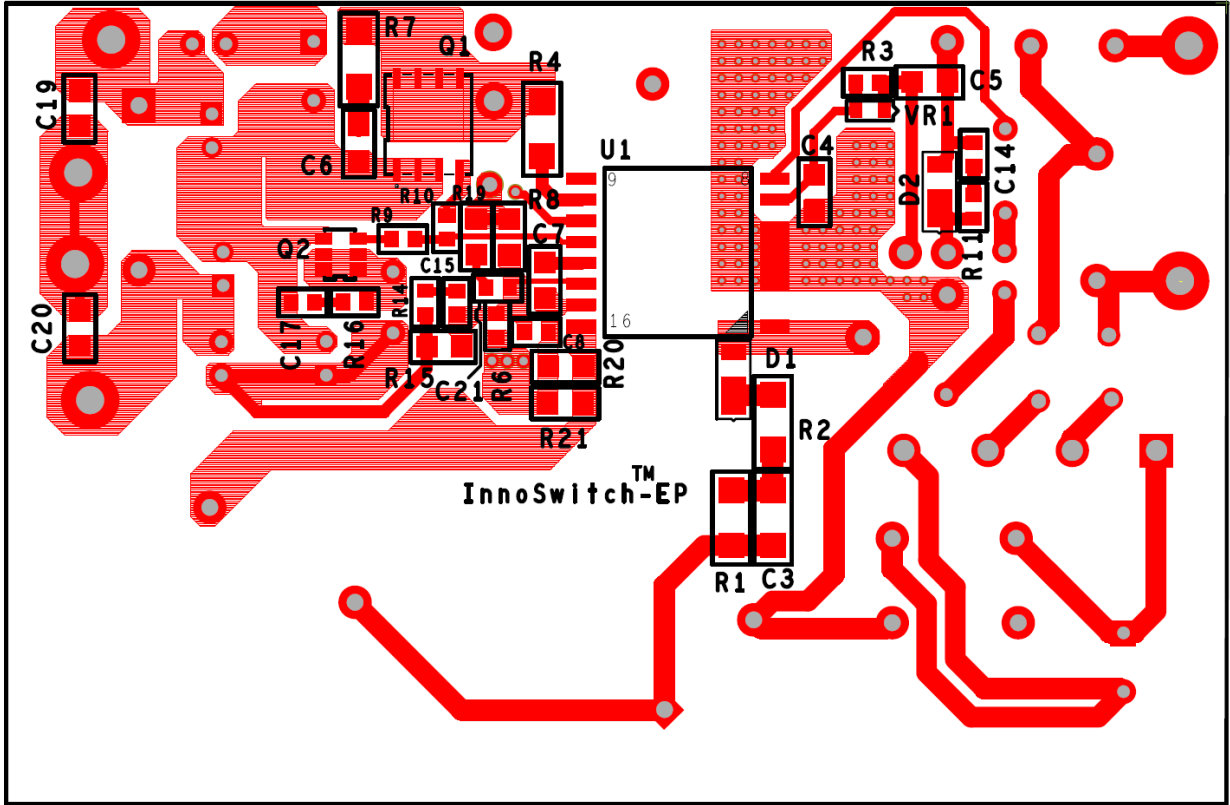

Figure 5 – Printed Circuit Layout, Bottom.



6 Bill of Materials

| Item | Qty | Ref Des | Description | Mfg Part Number | Mfg |
|------|-----|----------------|---|-----------------------|---------------------------------|
| 1 | 1 | 12V | Test Point, ORG, THRU-HOLE MOUNT | 5013 | Keystone |
| 2 | 1 | 5V | Test Point, RED, THRU-HOLE MOUNT | 5010 | Keystone |
| 3 | 3 | 5VRTN L RTN | Test Point, BLK, THRU-HOLE MOUNT | 5011 | Keystone |
| 4 | 1 | BR1 | DIODE BRIDGE 600V 4A GB | GBL06 | Genesic Semi |
| 5 | 1 | C1 | 10 μ F, 400 V, Electrolytic, (8 x 14) | EW2GM100F140T | Aishi |
| 6 | 1 | C2 | 33 μ F, 400 V, Electrolytic, Low ESR, 901 m Ω , (16 x 20) | EKMX401ELL330ML20S | Nippon Chemi-Con |
| 7 | 1 | C3 | 2.2 nF, 630 V, Ceramic, X7R, 1206 | C3216X7R2J222K | TDK |
| 8 | 3 | C4 C19 C20 | 1 μ F, 25 V, Ceramic, X5R, 0805 | C2012X5R1E105K | TDK |
| 9 | 1 | C5 | 22 μ F, 25 V, Ceramic, X5R, 0805 | C2012X5R1E226M125AC | TDK |
| 10 | 1 | C6 | 1.5 nF, 200 V, 10%, Ceramic, X7R, 0805 | 08052C152KAT2A | AVX |
| 11 | 1 | C7 | 2.2 μ F, 25 V, Ceramic, X7R, 0805 | C2012X7R1E225M | TDK |
| 12 | 1 | C8 | 330 pF 50 V, Ceramic, X7R, 0603 | CC0603KRX7R9BB331 | Yageo |
| 13 | 1 | C9 | 100 pF, Ceramic, Y1 | 440LT10-R | Vishay |
| 14 | 1 | C10 | 470 μ F, 16 V, Al Organic Polymer, 12 m Ω , (8 x 11.5) | RNE1C471MDN1 | Nichicon |
| 15 | 1 | C12 | 47 nF, 310 VAC, Polyester Film, X2 | BFC233920473 | Vishay |
| 16 | 1 | C13 | 47 μ F, 16 V, Electrolytic, Gen Purpose, (5 x 11.5) | ECA-1CHG470 | Panasonic |
| 17 | 1 | C14 | 220 pF, 250 V, Ceramic, COG, 0603 | C1608C0G2E221J | TDK |
| 18 | 3 | C15 C17 C21 | 1000 pF, 100 V, Ceramic, NPO, 0603 | C1608C0G2A102J | TDK |
| 19 | 1 | C16 | 560 μ F, 6.3 V, Al Organic Polymer, Gen. Purpose, 20% | RS80J561MDN1JT | Nichicon |
| 20 | 1 | C18 | 47 μ F, 16 V, Electrolytic, Low ESR, 500 m Ω , (5 x 11.5) | ELXZ160ELL470MEB5D | Nippon Chemi-Con |
| 21 | 1 | D1 | 600 V, 1 A, Rectifier, Glass Passivated, POWERDI123 | DFLR1600-7 | Diodes, Inc. |
| 22 | 1 | D2 | 200 V, 1 A, Rectifier, Glass Passivated, POWERDI123 | DFLR1200-7 | Diodes, Inc. |
| 23 | 1 | F1 | 2 A, 250 V, Slow, Long Time Lag,RST | RST 2 | Belfuse |
| 24 | 1 | L1 | 15 mH, Common Mode Choke | SNX-R1789 TSD-3641 | Santronics Premier Magnetics |
| 25 | 1 | L2 | Custom, 90 μ H, constructed on Core 35T0375-10H from PI# 30-00275-00 | SNX-R1790 TSD-3640 | Santronics Premier Magnetics |
| 26 | 2 | L4 L5 | 3.3 μ H, 1.5 A | 11R332C | Murata |
| 27 | 1 | N | Test Point, WHT, THRU-HOLE MOUNT | 5012 | Keystone |
| 28 | 1 | Q1 | 100 V, 40 A, N-Channel, PowerPAK SO-8 | SIR876ADP-T1-GE3 | Vishay |
| 29 | 1 | Q2 | MOSFET, N-CH, 60 V, 4.2 A, 6TSOP | AO6420 | Alpha & Omega Semi |
| 30 | 1 | R1 | 430 k Ω , 5%, 1/4 W, Thick Film, 1206 | ERJ-8GEYJ434V | Panasonic |
| 31 | 1 | R2 | 51 Ω , 5%, 1/4 W, Thick Film, 1206 | ERJ-8GEYJ510V | Panasonic |
| 32 | 1 | R3 | 6.8 k Ω , 5%, 1/10 W, Thick Film, 0603 | ERJ-3GEYJ682V | Panasonic |
| 33 | 1 | R4 | 47 Ω , 5%, 1/4 W, Thick Film, 1206 | ERJ-8GEYJ470V | Panasonic |
| 34 | 1 | R6 | 32.4 k Ω , 1%, 1/16 W, Thick Film, 0603 | ERJ-3EKF3242V | Panasonic |
| 35 | 1 | R7 | 10 Ω , 5%, 1/4 W, Thick Film, 1206 | ERJ-8GEYJ100V | Panasonic |
| 36 | 1 | R8 | 1 M Ω , 1%, 1/8 W, Thick Film, 0805 | ERJ-6ENF1004V | Panasonic |
| 37 | 2 | R9 R10 | 5.1 Ω , 5%, 1/10 W, Thick Film, 0603 | ERJ-3GEYJ5R1V | Panasonic |
| 38 | 1 | R11 | 100 Ω , 5%, 1/10 W, Thick Film, 0603 | ERJ-3GEYJ101V | Panasonic |
| 39 | 1 | R14 | 1 k Ω , 5%, 1/10 W, Thick Film, 0603 | ERJ-3GEYJ102V | Panasonic |
| 40 | 1 | R15 | 137 k Ω , 1%, 1/8 W, Thick Film, 0805 | ERJ-6ENF1373V | Panasonic |
| 41 | 1 | R16 | 5.6 Ω , 5%, 1/10 W, Thick Film, 0603 | ERJ-3GEYJ5R6V | Panasonic |
| 42 | 1 | R17 | 4.12 M Ω , 1%, 1/4 W, Metal Film | RNF14FTC4M12 | Stackpole |



| | | | | | |
|----|---|-----|--|-------------------------------------|---|
| 43 | 1 | R18 | 3.9 M Ω , 1%, 1/4 W, Metal Film | HHV-25FR-52-3M9 | Yageo |
| 44 | 1 | R19 | 1 k Ω , 5%, 1/8 W, Thick Film, 0805 | ERJ-6GEYJ102V | Panasonic |
| 45 | 1 | R20 | 0.02 Ω , 1%, 1/4 W, Thick Film, 0805 | RL0805FR-7W0R02L | Yageo |
| 46 | 1 | R21 | 0.04 Ω 1/8 W, 1%, Thick Film, 0805 | RL0805FR-070R04L | Yageo |
| 47 | 1 | T1 | Bobbin, RM8, Vertical, 12 pins Transformer Transformer | RM8/12/1 SNX-R1788 POL-INN010 | Schwartzpunkt Santrouincs Premier Magnetics |
| 48 | 1 | U1 | InnoSwitch-EP, Off-Line CV/CC Flyback Switcher, ReSOP-16B | INN2605K | Power Integrations |
| 49 | 1 | VR1 | 8.2 V, 5%, 150 mW, SSMINI-2 | DZ2S08200L | Panasonic |
| 50 | 1 | VR2 | 8.2 V, 5%, 1 W, DO-41 | 1N4738A,113 | NXP Semi |

7 Transformer (T1) Specification

7.1 Electrical Diagram

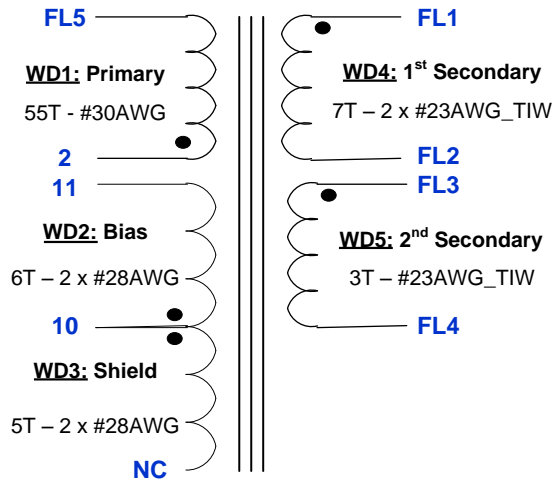

Figure 6 – Transformer Electrical Diagram.

7.2 Electrical Specifications

| Parameter | Condition | Spec. |
|-----------------------------------|--|-----------------------|
| Nominal Primary Inductance | Measured at 1 V pk-pk, 100 kHz switching frequency, between pin 2 and FL5, with all other windings open. | 545 μ H \pm 10% |
| Resonant Frequency | Between pin 2 and FL5, other windings open. | 1100 kHz (Min.) |
| Primary Leakage Inductance | Between pin 2 and FL5, with FL1, FL2, FL3, FL4 shorted. | 20 μ H (Max). |

7.3 Material List

| Item | Description |
|------|---|
| [1] | Core: RM8, PC95 TDK or DMR95 from DMEGC magnetics. |
| [2] | Bobbin: RM8, Vertical, 12 pins (6/6-circular) (PI P/N: 25-1022-00). |
| [3] | Core Clip: Allstar Magnetic, P/N: CLI/P-RM8/I. |
| [4] | Magnet wire: #30 AWG, double coated. |
| [5] | Magnet wire: #28 AWG, double coated. |
| [6] | Magnet wire: #23 AWG, Triple Insulated Wire. |
| [7] | Barrier Tape: 3M 1298 Polyester Film, 1 mil thickness, 9.0 mm wide. |
| [8] | Varnish: Dolph BC-359. |

7.4 Transformer Build Diagram

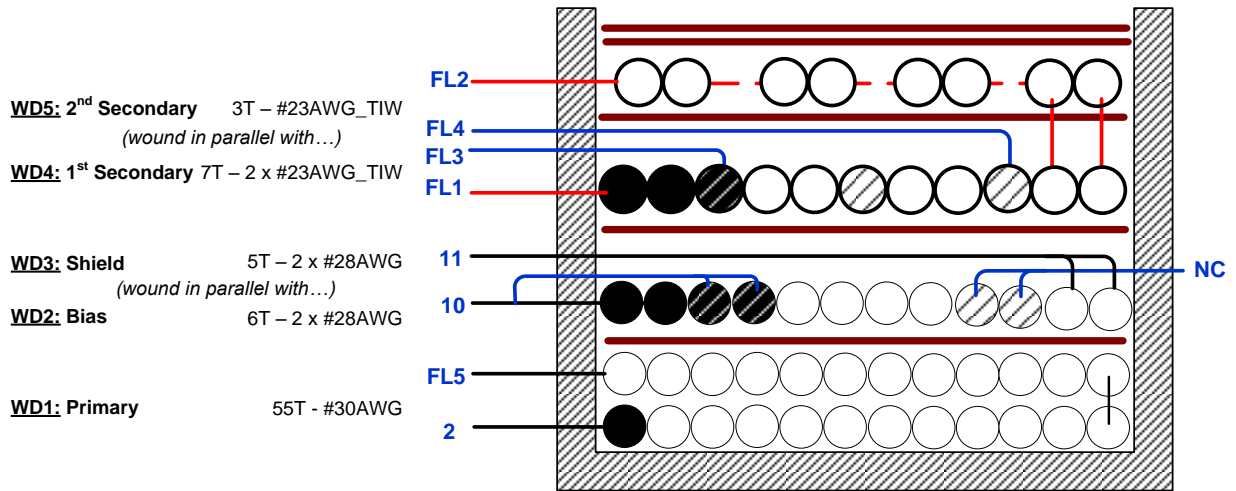
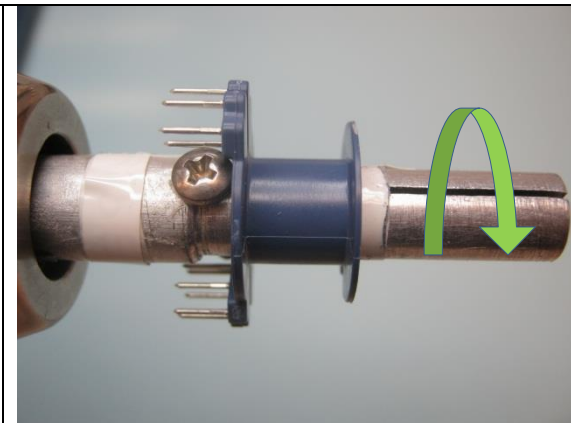
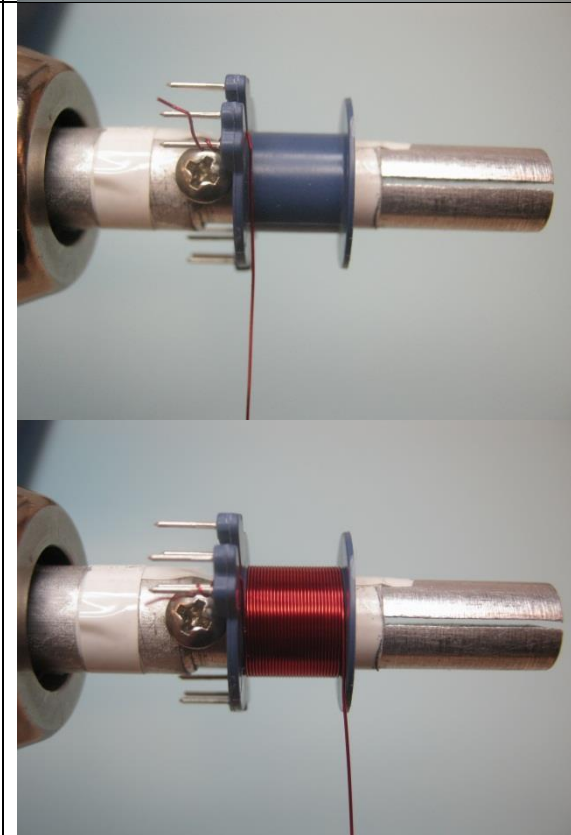

Figure 7 – Transformer Build Diagram.

7.5 Winding Instructions

| | |
|--|--|
| Winding Preparation | For the purpose of these instructions, bobbin item [1] is oriented on winder such that pin side is on the left side. Winding direction is clockwise direction. |
| WD1 Primary | Start at pin 2, wind 55 turns of wire item [4] from left to right then right to left in 2 layers and finish as FL5 floating. |
| Insulation | 1 layer of tape item [7] for insulation. |
| WD2 Bias & WD3 Shield | Take 4 wires item [5], start at pin 10, wind 5 turns, cut 2 wires and leave no-connect for WD3-Shield. Continue winding 1 more turn for other 2 wires and bring these wire to the left to finish at pin 11 for WD2-Bias. |
| Insulation | 1 layer of tape item [7] for insulation. |
| WD4 1st Secondary & WD5 2nd Secondary | Take 3 wires item [6], (WD4-1 st Secondary needs 2 wires, WD5-2 nd Secondary needs single wire), designate start leads FL1 for WD4 and FL3 for WD5. Wind 3 turns, at the 3 rd turn, bring the single wire to the left, and leave floating as FL4 for WD5. Place 1 layer of tape to secure the winding, then continue winding 4 more turns of other 2 wires from right to left and leave floating as FL2 for WD4. |
| Insulation | 2 layers of tape item [7] for insulation and secure the windings. |
| Finish | Cut short FL1, FL2 to ~20.0 mm, and FL4, FL4 to ~30.0 mm. Gap the core halves to get 545 μH. Assemble the core halves with clip item [3]. Cut short leg of bottom clip (see picture below). Remove pins: 1,3,4,5,7,8, and 9. Varnish with item [8]. |

7.6 **Winding Illustrations**

| | | |
|-----------------------------------|---|---|
| <p>Winding Preparation</p> |  A photograph of a bobbin assembly. A blue bobbin is mounted on a metal core. A green curved arrow indicates a clockwise winding direction. | <p>For the purpose of these instructions, bobbin item [1] is oriented on winder such that pin side is on the left side. Winding direction is clockwise direction.</p> |
| <p>WD1 Primary</p> |  Two photographs showing the winding process. The top photo shows a red wire being inserted into the bobbin. The bottom photo shows the completed primary winding, which consists of two layers of red wire. | <p>Start at pin 2, wind FL5 55 turns of wire item [4] from left to right then right to left in 2 layers and finish as FL5 floating.</p> |

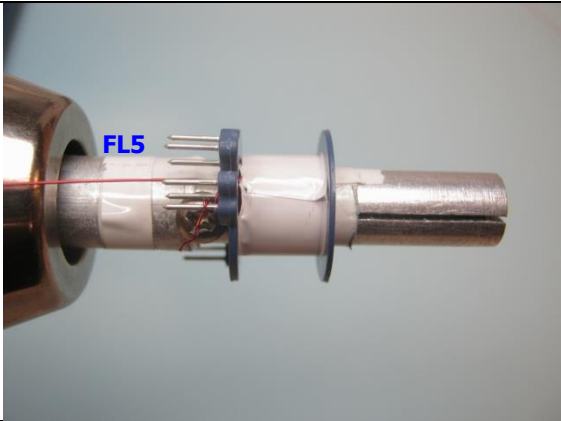
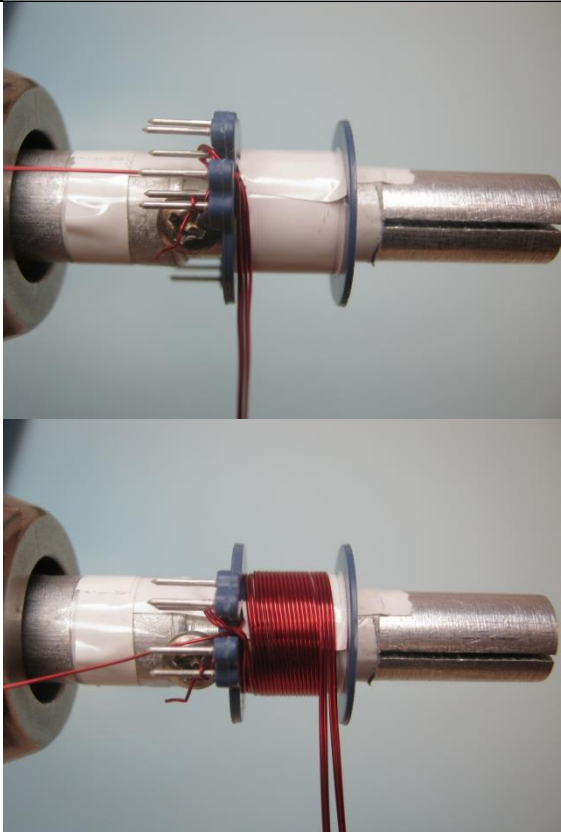
| | | |
|----------------------------------|---|---|
| Insulation |  | 1 layer of tape item [7] for insulation. |
| WD2 Bias & WD3 Shield |  | Take 4 wires item [5], start at pin 10, wind 5 turns. |

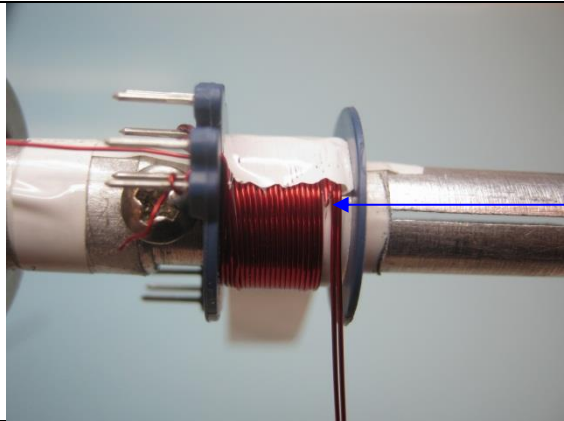
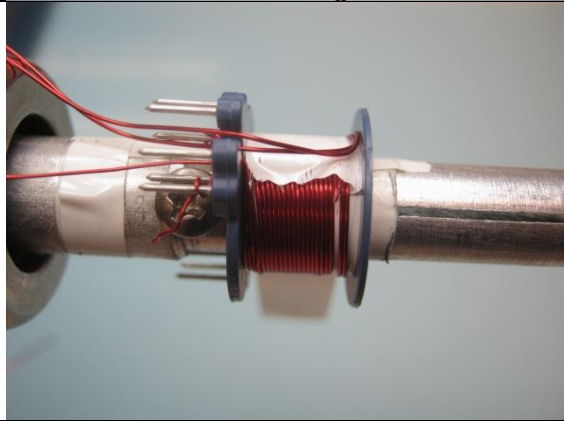
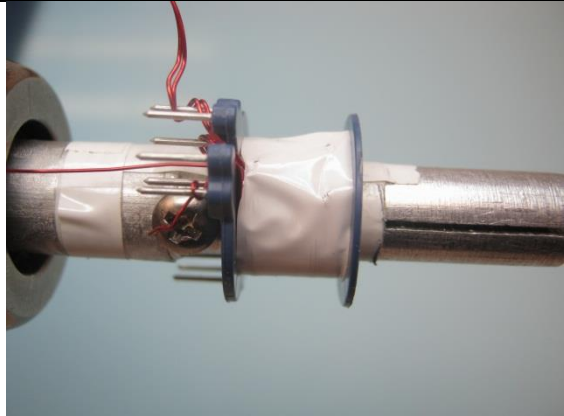
| | | |
|--------------------------|--|--|
| |  | <p>Cut 2 wires and <u>leave no-connect</u> for WD3-Shield.</p> |
| |  | <p>Continue winding 1 more turn for other 2 wires and bring these wire to the left to finish at pin 11 for WD2-Bias.</p> |
| <p>Insulation</p> |  | <p>1 layer of tape item [7] for insulation.</p> |

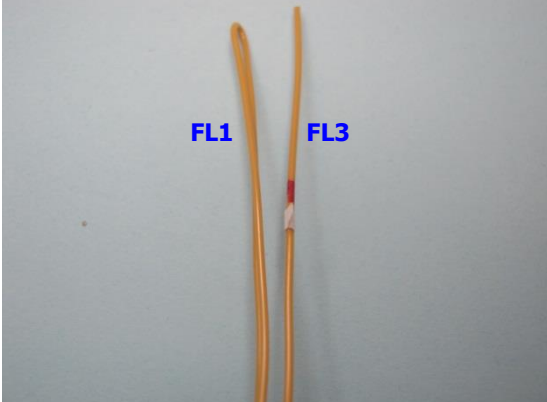
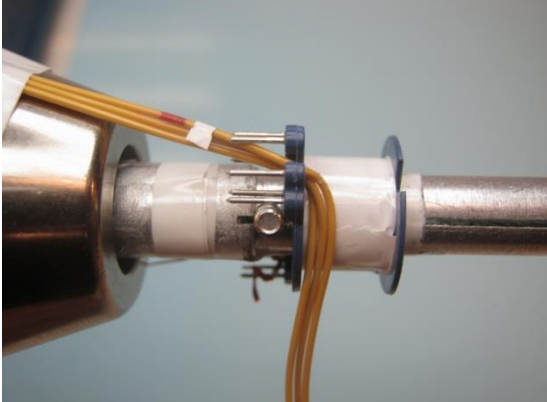
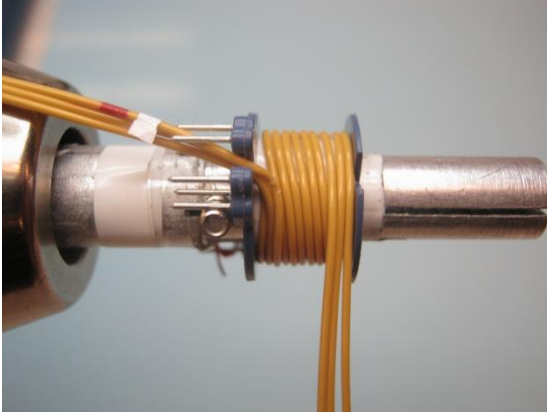
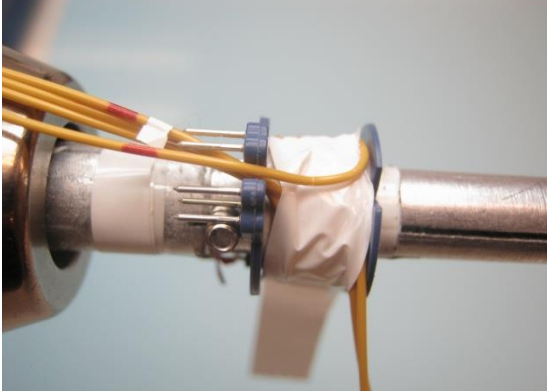
| | | |
|---|---|---|
| <p>WD4 1st Secondary & WD5 2nd Secondary</p> |   | <p>Take 3 wires item [6], (WD4-1st Secondary needs 2 wires, WD5-2nd Secondary needs single wire), designate start leads FL1 for WD4 and FL3 for WD5.</p> |
| |   | <p>Wind 3 turns, at the 3rd turn, bring the single wire to the left, and leave floating as FL4 for WD5. Place 1 layer of tape to secure the winding, then continue winding 4 more turns of other 2 wires from right to left and leave floating as FL2 for WD4.</p> |

| | | |
|----------------------|--|--|
| | | |
| | | <p>2 layers of tape item [7] for insulation and secure the windings.</p> |
| <p>Finish</p> | | <p>Cut short FL1, FL2 to ~20.0 mm, and FL4, FL4 to ~30.0 mm. Gap the core halves to get 545 μH. Assemble the core halves with clip item [3]. Remove pins: 1, 3, 4, 5, 7, 8, and 9. <u>Cut short leg of bottom clip.</u> Varnish with item [8].</p> |

8 15 mH Common Mode Choke (L1) Specification

8.1 *Electrical Diagram*

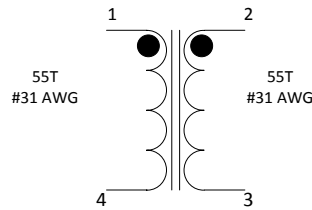

Figure 8 – Inductor Electrical Diagram.

8.2 *Electrical Specifications*

| | | |
|-----------------------------------|--|------------------------|
| Inductance | Pins 1-4 and pins 2-3 measured at 100 kHz, 0.4 RMS | 13 mH \pm 25% |
| Core Effective Inductance | | 4960 nH/N ² |
| Primary Leakage Inductance | Pins 1-4, with 2-3 shorted | 80 μ H |

8.3 *Material List*

| Item | Description |
|------|--|
| [1] | Toroid: FERRITE INDUCTR TOROID, PI Part number: #32-00286-00 1) JLW Electronics (Hong Kong), T14 x 8 x 5. 5C-JL10 2) TDK, B64290L0658 x 038 material |
| | Divider -- Fish paper, insulating cotton rag, 0.010" thick, PI #: 66-00042-00. Cut to size 8 mm x 5.5 mm. |
| [2] | Magnet Wire: #31 AWG Heavy Nyleze. |

8.4 *Winding Instructions*

- Use 4 ft of item [2], start at pin 1 wind 55 turns end at pin 4.
- Do the same for another half of Toroid, start at pin 2 and end at pin 3.

8.5 *Illustrations*

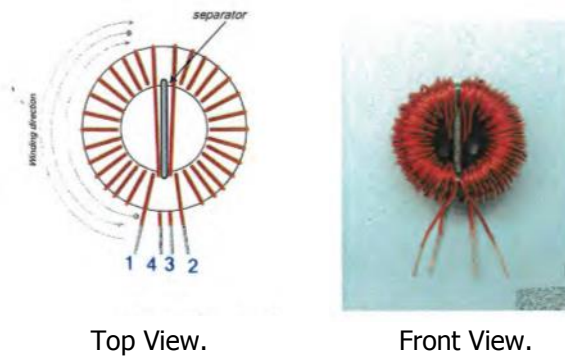

Top View.

Front View.

9 90 μH Common Mode Choke (L2) Specification

9.1 Electrical Diagram

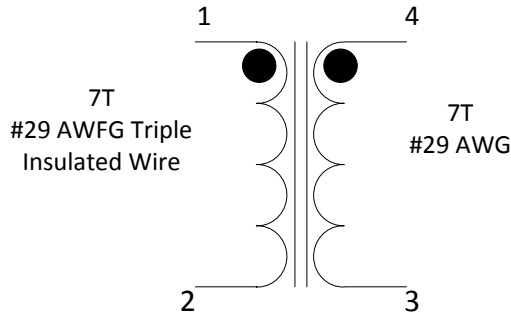

Figure 9 – Inductor Electrical Diagram.

9.2 Electrical Specifications

| | | |
|-----------------------------------|--|------------|
| Inductance | Pins 1-2 measured at 100 kHz, 0.4 RMS. | 90 μH ±25% |
| Resonant Frequency | Pins 1-2, all other windings open. | |
| Primary Leakage Inductance | Pins 1-2, with 3-4 shorted. | 0.5 μH |

9.3 Material List

| Item | Description |
|------|--|
| [1] | 1) Toroid: FERRITE INDUCTR TOROID .415" OD ;Mfg Part number: 35T0375-10H Dim: 9.53 mm O.D. x 4.75 mm I.D. x 3.18 mm L, PI Part number: 32-00275-00. 2) Toroid: Ferrite core, TDK, B64290L38x30,PI Part number : 32-00329-00. |
| [2] | Magnet Wire: #29 AWG. |
| [3] | Triple Insulated wire #29 AWG. |

9.4 Illustrations

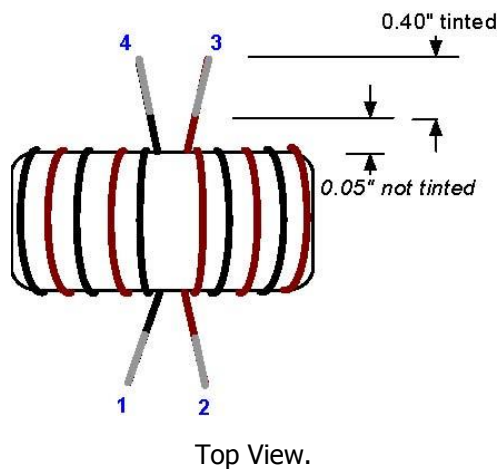

10 Transformer Design Spreadsheet

| ACDC_InnoSwitch-CH_102014; Rev.2.0; Copyright Power Integrations 2014 | INPUT | INFO | OUTPUT | UNIT | ACDC_InnoSwitch-CH_101714_Rev2-0; InnoSwitch-CH Continuous/Discontinuous Flyback Transformer Design Spreadsheet |
|---|----------------|-------------|--------------------------------|--------------------|--|
| ENTER APPLICATION VARIABLES | | | | | |
| VACMIN | | | 85 | V | Minimum AC Input Voltage |
| VACMAX | | | 265 | V | Maximum AC Input Voltage |
| fL | | | 50 | Hz | AC Mains Frequency |
| VO | 12.00 | | 12.00 | V | Output Voltage (continuous power at the end of the cable) |
| IO | 1.75 | | 1.75 | A | Power Supply Output Current (corresponding to peak power) |
| Power | | Info | 21 | W | Specified Output Power exceeds the value specified on the datasheet for universal input adapter. Please verify performance on bench |
| n | 0.87 | | 0.87 | | Efficiency Estimate at output terminals. Use 0.8 if no better data available |
| Z | | | 0.50 | | Z Factor. Ratio of secondary side losses to the total losses in the power supply. Use 0.5 if no better data available |
| tC | | | 3.00 | mSeconds | Bridge Rectifier Conduction Time Estimate |
| CIN | 44.00 | | 44.00 | uFarad | Input Capacitance |
| ENTER InnoSwitch-CH VARIABLES | | | | | |
| InnoSwitch-CH | INN20x5 | | INN20x5 | | User defined InnoSwitch |
| Cable drop compensation | 0% | | 0% | | Select Cable Drop Compensation option |
| Complete Part Number | | | INN2005K | | Final part number including package |
| Chose Configuration | INC | | Increased Current Limit | | Enter "RED" for reduced current limit (sealed adapters), "STD" for standard current limit or "INC" for increased current limit (peak or higher power applications) |
| ILIMITMIN | | | 0.955 | A | Minimum Current Limit |
| ILIMITTYP | | | 1.050 | A | Typical Current Limit |
| ILIMITMAX | | | 1.145 | A | Maximum Current Limit |
| fSmin | | | 93000 | Hz | Minimum Device Switching Frequency |
| I ² fmin | | | 92.61 | A ² kHz | Worst case I ² F parameter across the temperature range |
| VOR | 100 | | 100 | V | Reflected Output Voltage (VOR <= 100 V Recommended) |
| VDS | | | 5.00 | V | InnoSwitch on-state Drain to Source Voltage |
| KP | | | 0.92 | | Ripple to Peak Current Ratio at Vmin, assuming ILIMITMIN, and I2FMIN (KP < 6) |
| KP_TRANSIENT | | | 0.54 | | Worst case transient Ripple to Peak Current Ratio. Ensure KP_TRANSIENT > 0.25 |
| ENTER BIAS WINDING VARIABLES | | | | | |
| VB | | | 10.00 | V | Bias Winding Voltage |
| VDB | | | 0.70 | V | Bias Winding Diode Forward Voltage Drop |
| NB | | | 5.79 | V | Bias Winding Number of Turns |
| PIVB | | | 64.34 | V | Bias winding peak reverse voltage at VACmax and assuming VB*1.2 |
| ENTER TRANSFORMER CORE/CONSTRUCTION VARIABLES | | | | | |
| Core Type | RM8 | | RM8 | | Enter Transformer Core |
| Core | | | PC47RM8Z-12 | | Enter core part number, if necessary |
| Bobbin | | | BRM8-718CPFR | | Enter bobbin part number, if necessary |
| AE | | | 0.640 | cm ² | Core Effective Cross Sectional Area |
| LE | | | 3.80 | cm | Core Effective Path Length |
| AL | | | 1950 | nH/T ² | Ungapped Core Effective Inductance |
| BW | | | 9.05 | mm | Bobbin Physical Winding Width |
| M | 0.00 | | 0.00 | mm | Safety Margin Width (Half the Primary to |

| | | | | | |
|--|------|--|-------|-------------------|--|
| | | | | | Secondary Creepage Distance) |
| L | 2 | | 2 | | Number of Primary Layers |
| NS | 7 | | 7 | | Number of Secondary Turns |
| DC INPUT VOLTAGE PARAMETERS | | | | | |
| VMIN | | | 82 | V | Minimum DC Input Voltage |
| VMAX | | | 375 | V | Maximum DC Input Voltage |
| CURRENT WAVEFORM SHAPE PARAMETERS | | | | | |
| DMAX | | | 0.56 | | Duty Ratio at full load, minimum primary inductance and minimum input voltage |
| IAVG | | | 0.29 | A | Average Primary Current |
| IP | | | 0.955 | A | Peak Primary Current assuming I _{LIMITMIN} |
| IR | | | 0.875 | A | Primary Ripple Current assuming I _{LIMITMIN} , and L _{PMIN} |
| IRMS | | | 0.43 | A | Primary RMS Current, assuming I _{LIMITMIN} , and L _{PMIN} |
| TRANSFORMER PRIMARY DESIGN PARAMETERS | | | | | |
| LP | | | 545 | uHenry | Typical Primary Inductance. +/- 10% to ensure a minimum primary inductance of 490 uH |
| LP_TOLERANCE | 10.0 | | 10.0 | % | Primary inductance tolerance |
| NP | | | 58 | | Primary Winding Number of Turns |
| ALG | | | 162 | nH/T ² | Gapped Core Effective Inductance |
| BM | | | 1999 | Gauss | Maximum Operating Flux Density, BM<3000 is recommended |
| BAC | | | 915 | Gauss | AC Flux Density for Core Loss Curves (0.5 X Peak to Peak) |
| ur | | | 921 | | Relative Permeability of Ungapped Core |
| LG | | | 0.45 | mm | Gap Length (L _g > 0.1 mm) |
| BWE | | | 18.1 | mm | Effective Bobbin Width |
| OD | | | 0.31 | mm | Maximum Primary Wire Diameter including insulation |
| INS | | | 0.05 | mm | Estimated Total Insulation Thickness (= 2 * film thickness) |
| DIA | | | 0.26 | mm | Bare conductor diameter |
| AWG | | | 30 | AWG | Primary Wire Gauge (Rounded to next smaller standard AWG value) |
| CM | | | 102 | Cmils | Bare conductor effective area in circular mils |
| CMA | | | 235 | Cmils/Amp | Primary Winding Current Capacity (200 < CMA < 500) |
| TRANSFORMER SECONDARY DESIGN PARAMETERS | | | | | |
| Lumped parameters | | | | | |
| ISP | | | 7.91 | A | Peak Secondary Current, assuming I _{LIMITMIN} |
| ISRMS | | | 3.15 | A | Secondary RMS Current |
| IRIPPLE | | | 2.62 | A | Output Capacitor RMS Ripple Current |
| CMS | | | 630 | Cmils | Secondary Bare Conductor minimum circular mils |
| AWGS | | | 22 | AWG | Secondary Wire Gauge (Rounded up to next larger standard AWG value) |
| VOLTAGE STRESS PARAMETERS | | | | | |
| VDRAIN | | | 605 | V | Maximum Drain Voltage Estimate |
| PIVS | | | 76 | V | Output Rectifier Maximum Peak Inverse Voltage, assuming the primary has a Voltage spike 40% above VMAX and VO*1.05 |
| TRANSFORMER SECONDARY DESIGN PARAMETERS | | | | | |
| 1st output | | | | | |
| VO1 | | | 12.00 | V | Main Output Voltage directly after output rectifier |
| IO1 | | | 1.75 | A | Output DC Current |
| PO1 | | | 21.00 | W | Output Power |
| VD1 | | | 0.10 | V | Output Synchronous Rectification FET Forward Voltage Drop |
| NS1 | | | 7.00 | Turns | Output Winding Number of Turns |



| | | | | | |
|--------------------|--|--|---------------|-------|--|
| ISRMS1 | | | 3.15 | A | Output Winding RMS Current |
| IRIPPLE1 | | | 2.62 | A | Output Capacitor RMS Ripple Current |
| PIVS1 | | | 76 | V | Output Rectifier Maximum Peak Inverse Voltage, assuming the primary has a Voltage spike 40% above VMAX and VO*1.05 |
| Recommended MOSFET | | | Si7456 | | Recommended SR FET for this output |
| RDSON_HOT | | | 0.042 | Ohm | RDSon at 100C |
| VRATED | | | 100 | V | Rated voltage of selected SR FET |
| CMS1 | | | 630 | Cmils | Output Winding Bare Conductor minimum circular mils |
| AWGS1 | | | 22 | AWG | Wire Gauge (Rounded up to next larger standard AWG value) |
| DIAS1 | | | 0.65 | mm | Minimum Bare Conductor Diameter |
| ODS1 | | | 1.29 | mm | Maximum Outside Diameter for Triple Insulated Wire |



11 Performance Data

11.1 Full Load Efficiency vs. Line

Two SR FETS (SIR876 & AO6420) vs. One SR FET + one Schottky diode (SIR876 and SS24). (Need to have 60 Ω load on the 5 V output to be comparable with two SR FETs in cross regulation with SS24.)

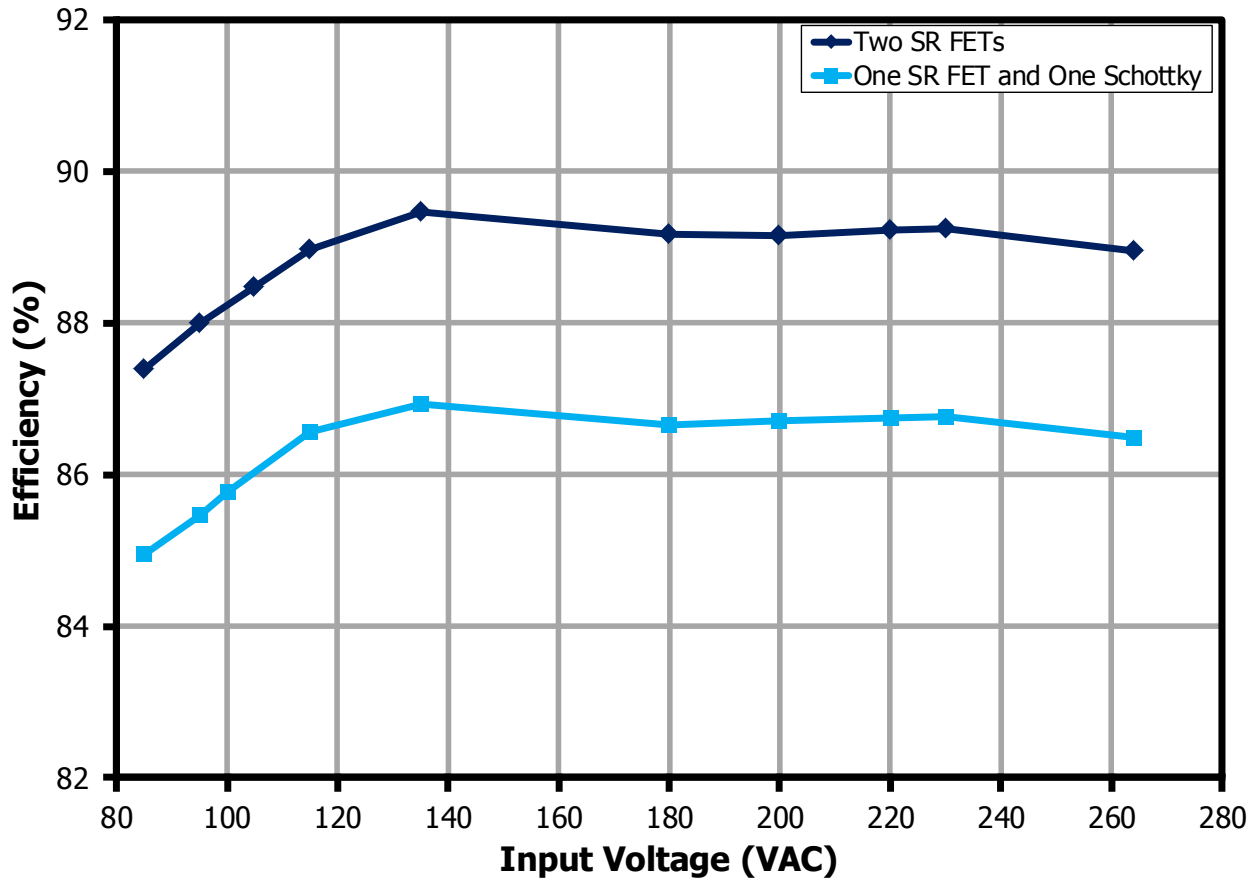

Figure 10 – Full load Efficiency vs. Line Voltage, Room Temperature.

11.2 **Efficiency vs. Load (0 A – 1.5 A on 12 V, Full Load on 5 V)**

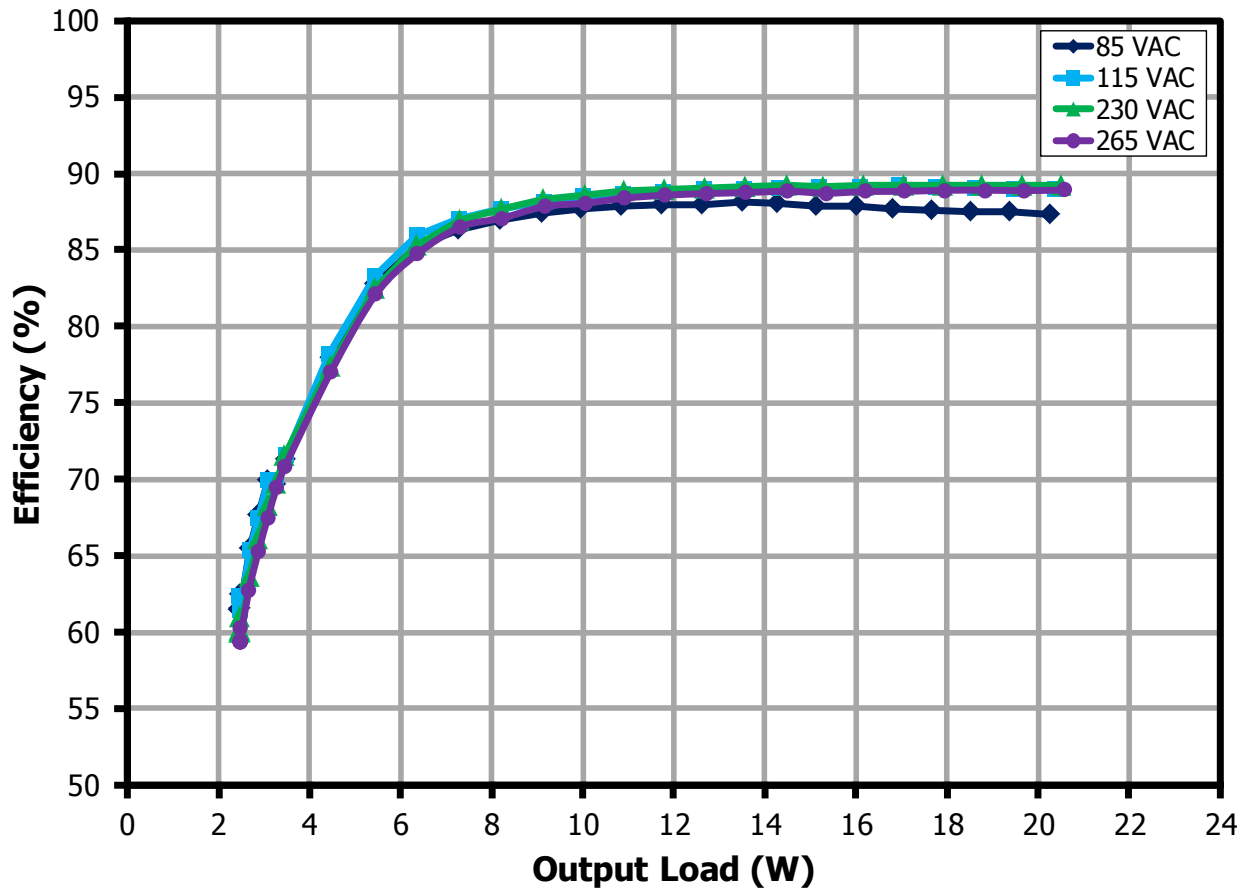

Figure 11 – Efficiency vs. Load, Room Ambient.



11.3 Efficiency vs. Load (0 A – 1.5 A on 12 V, No-Load on 5 V)

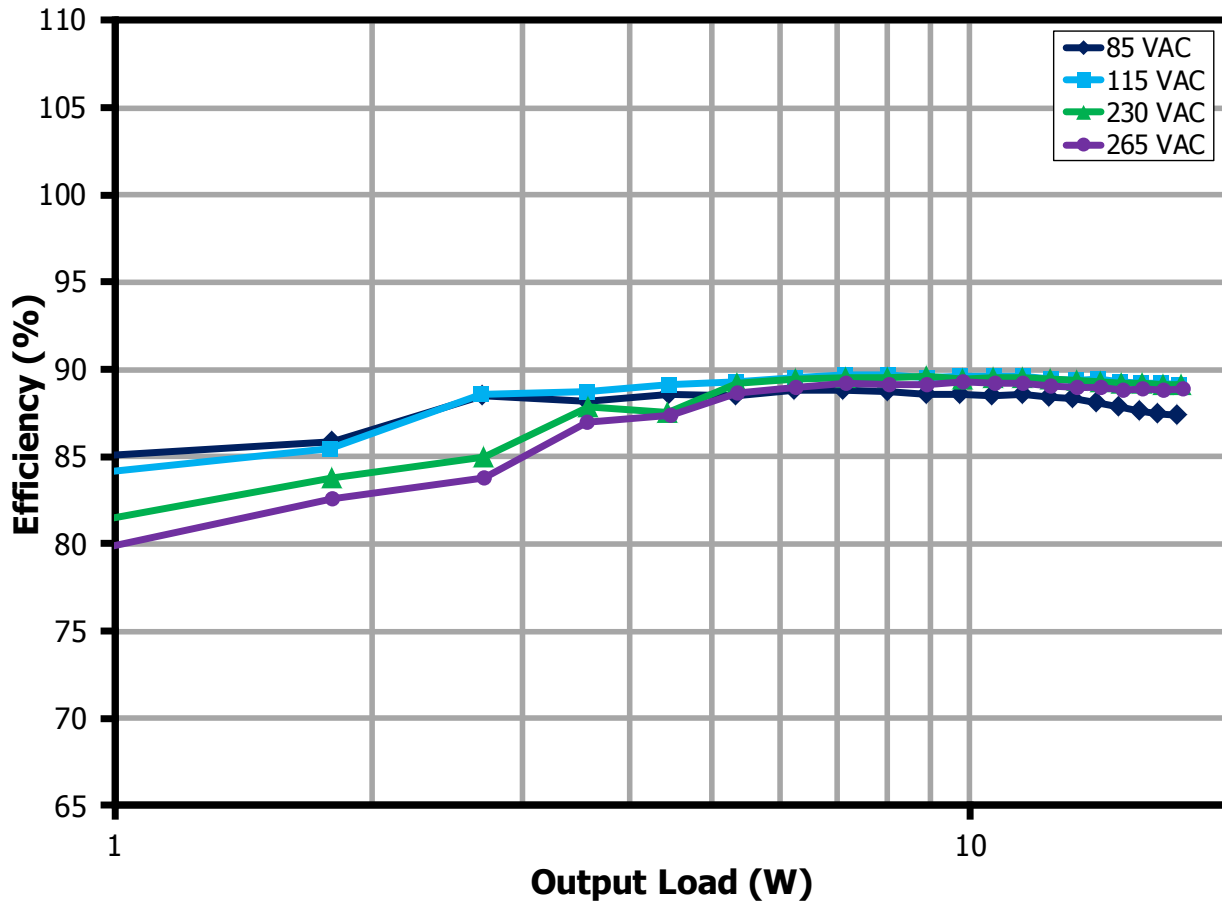

Figure 12 – Efficiency vs. Load (Log Scale to Demonstrate Light Load Performance).

11.4 **No-Load Input Power**

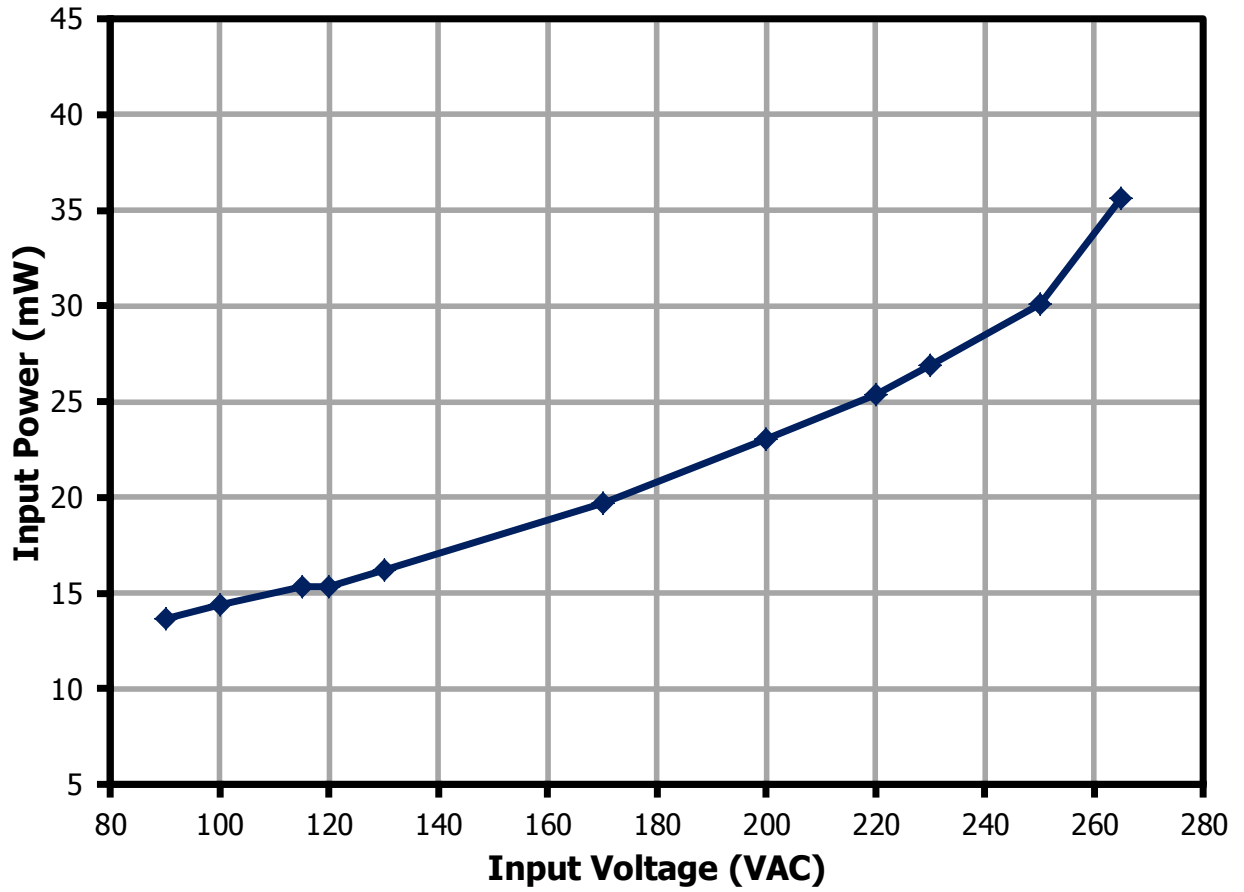

Figure 13 – No-Load Input Power vs. Input Line Voltage, Room Temperature.



11.5 **5 V Output Power with Low Input Power (No-Load on 12 V)**

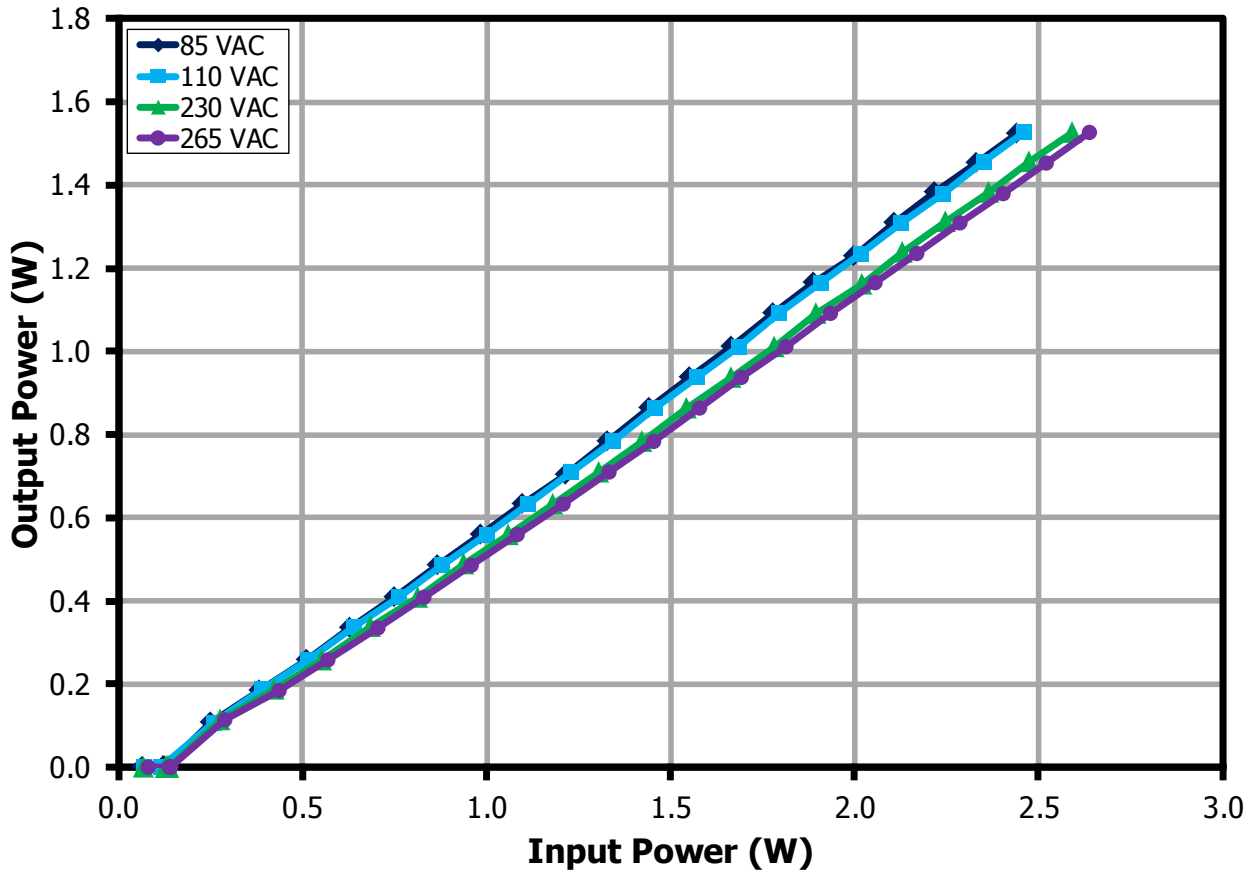

Figure 14 – 5 V Output Power vs. 12 V No-Load Input Power.

11.6 Line and Load Regulation

11.6.1 Line Regulation (Full load)

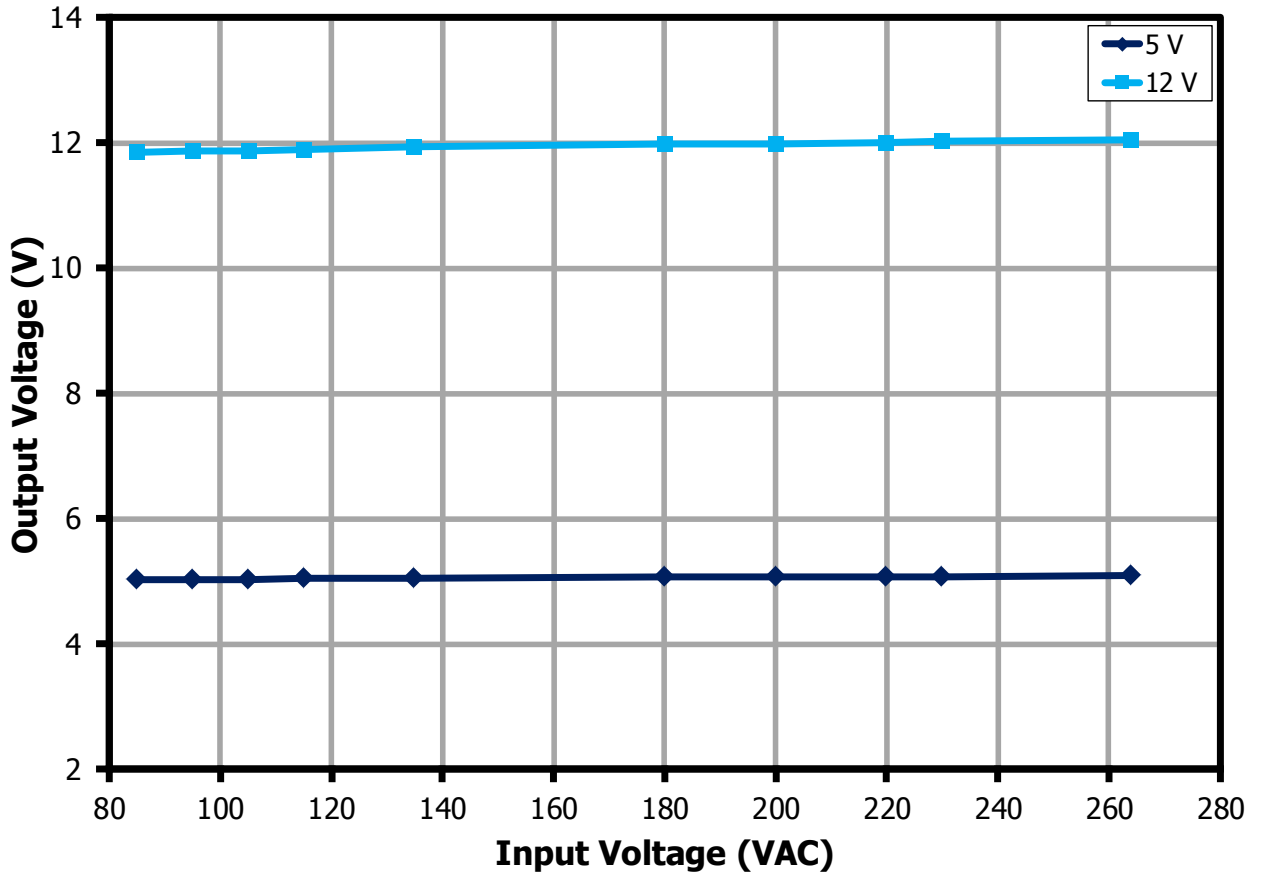

Figure 15 – Output Voltage vs. Input Line Voltage, Room Temperature.

| | 5 V | 12 V |
|------|--------|---------|
| Min. | 5.03 V | 11.87 V |
| Max. | 5.09 V | 12.04 V |



11.6.2 Cross Load Regulation

11.6.2.1 12 V Load Change with Full Load on 5 V

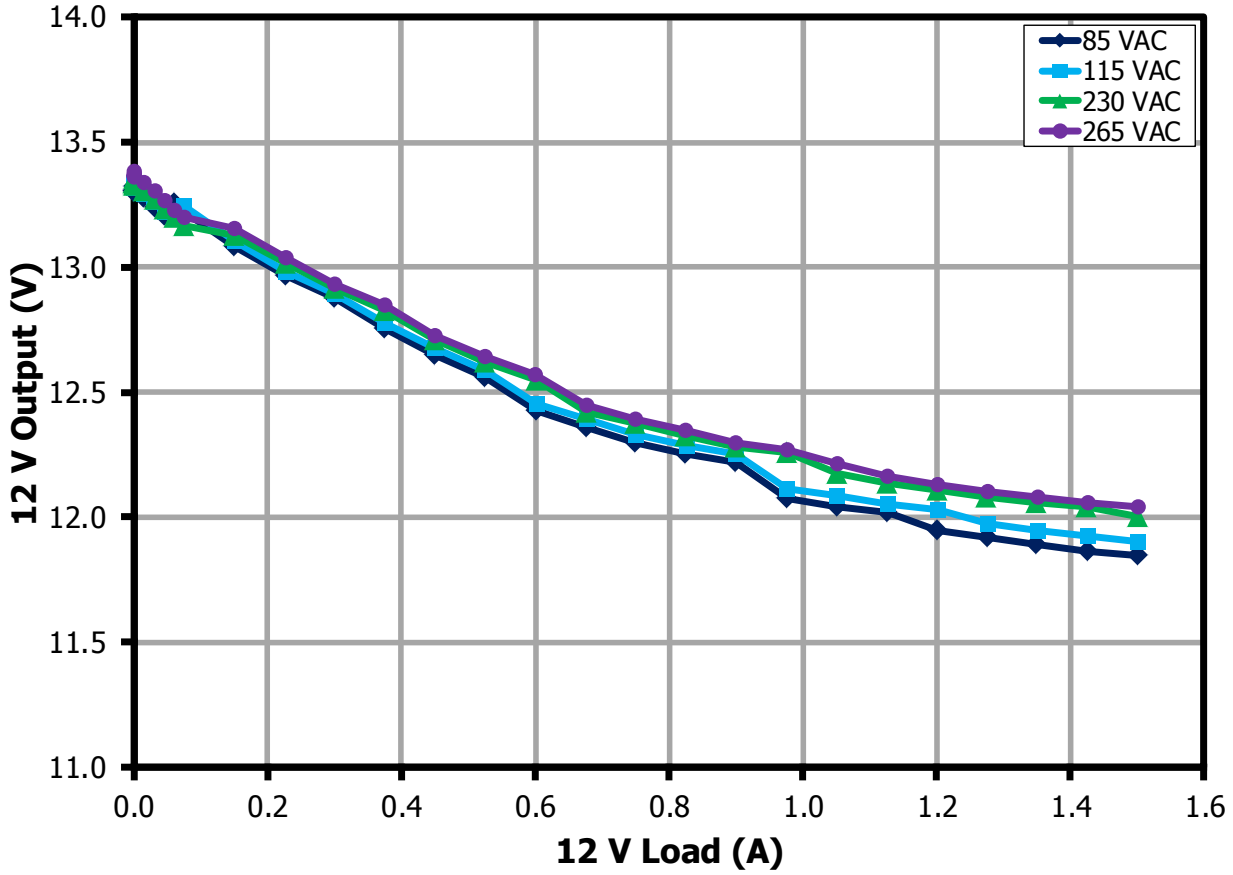

Figure 16 – 12 V Output Voltage vs. Output Load, Room Temperature.

| | 5 V | 12 V |
|-------------|--------|---------|
| Min. | 4.93 V | 11.85 V |
| Max. | 5.04 V | 13.39 V |

11.6.2.2 12 V Load Change with No Load on 5 V

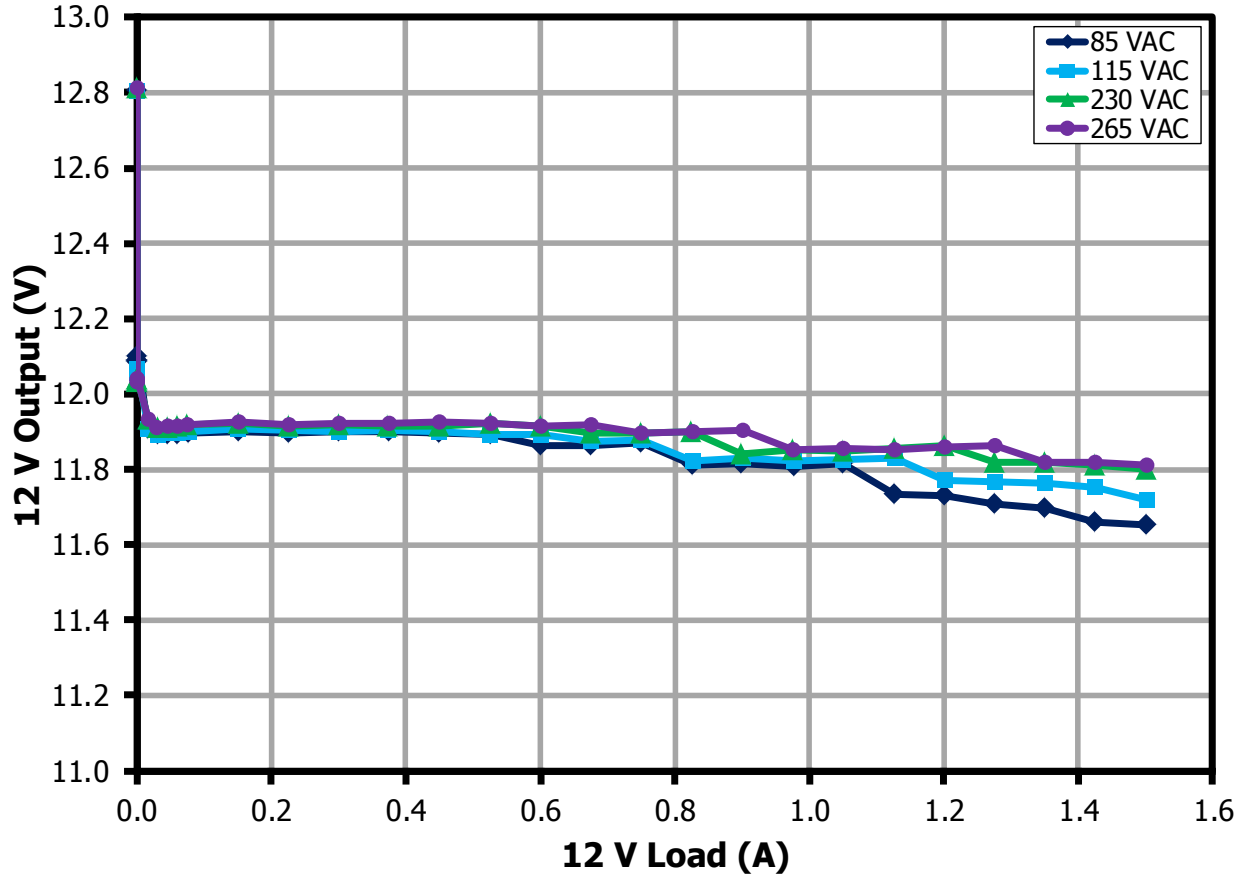

Figure 17 – 12 V Output Voltage vs. Output Load, Room Temperature.

| | 5 V | 12 V |
|-------------|--------|---------|
| Min. | 5.05 V | 11.65 V |
| Max. | 5.20 V | 12.81 V |



11.6.2.3 5 V Load Change with Full Load on 12 V

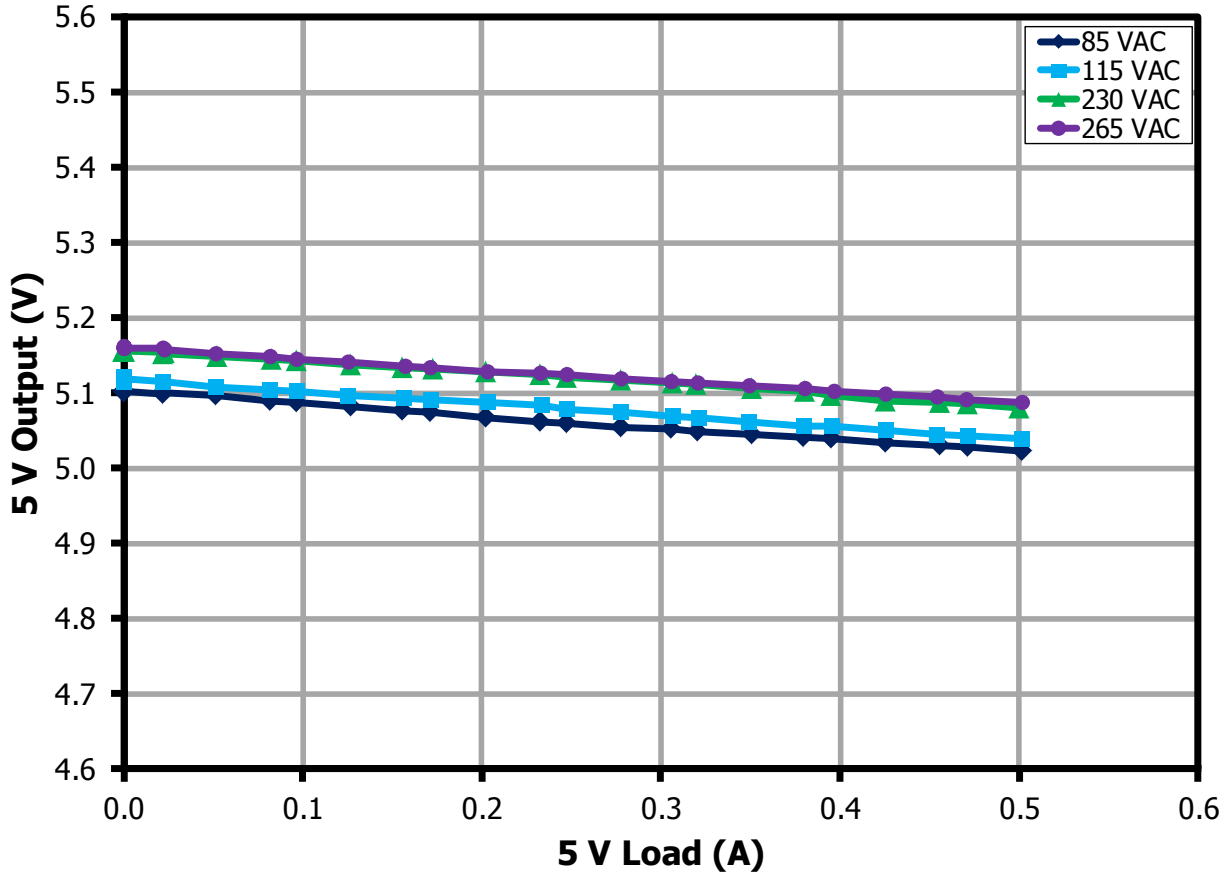

Figure 18 – 5 V Output Voltage vs. Output Load, Room Temperature.

| | 5 V | 12 V |
|-------------|--------|---------|
| Min. | 5.02 V | 11.66 V |
| Max. | 5.16 V | 11.86 V |

11.6.2.4 5 V Load Change with No Load on 12 V

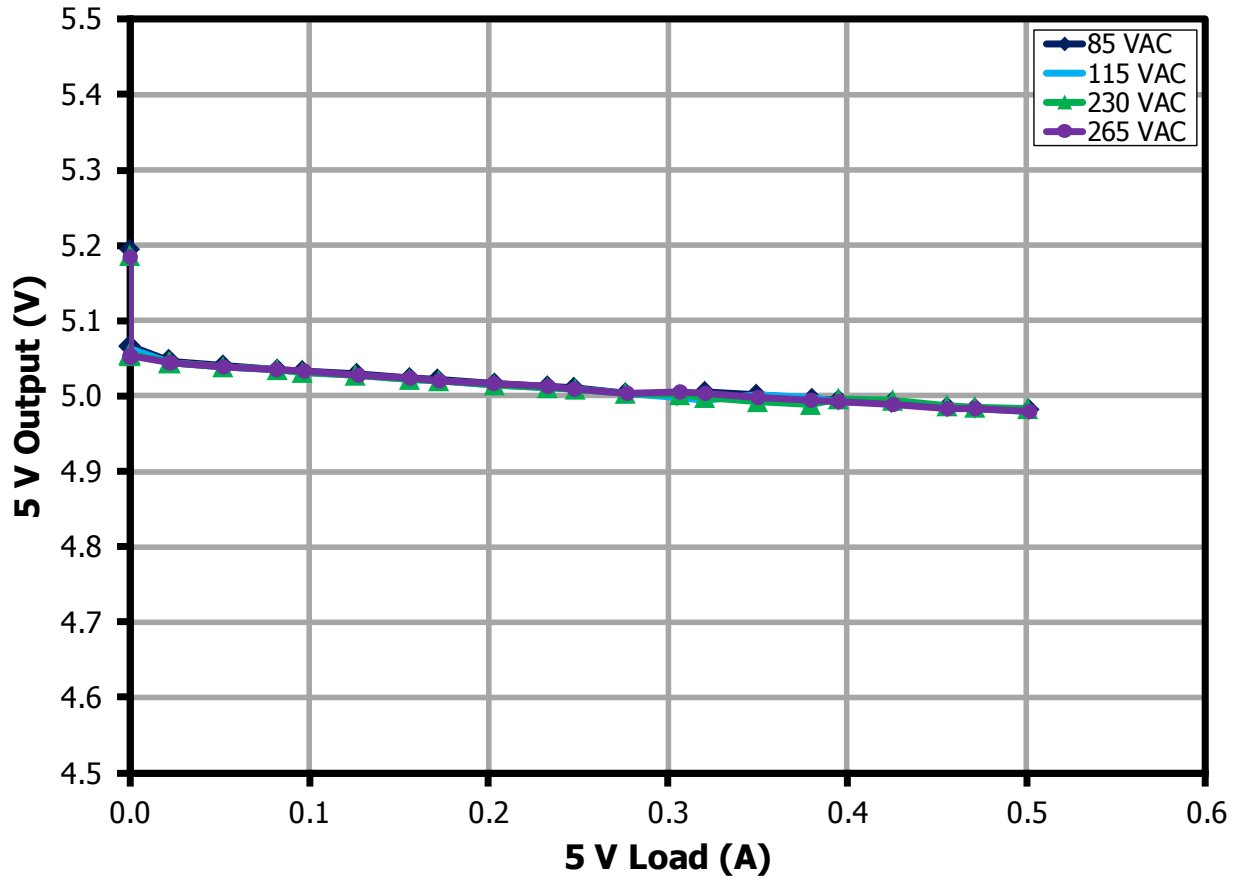

Figure 19 – 5 V Output Voltage vs. Output Load, Room Temperature.

| | 5 V | 12 V |
|-------------|--------|---------|
| Min. | 4.98 V | 11.77 V |
| Max. | 5.19 V | 13.33 V |



12 Thermal Performance

12.1 85 VAC

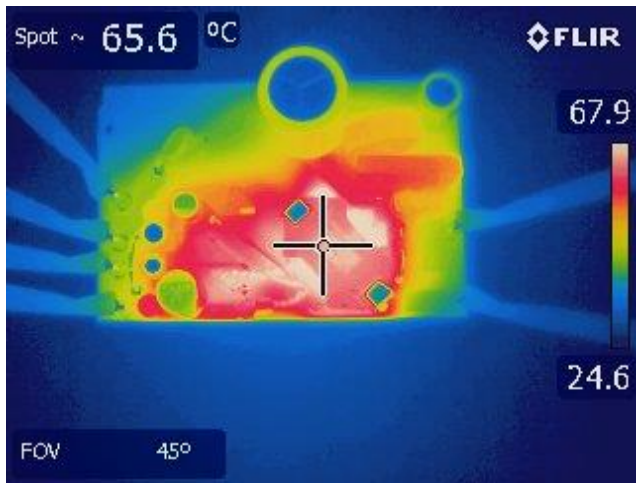

Figure 20 – Transformer Side. 85 VAC, Full Load.

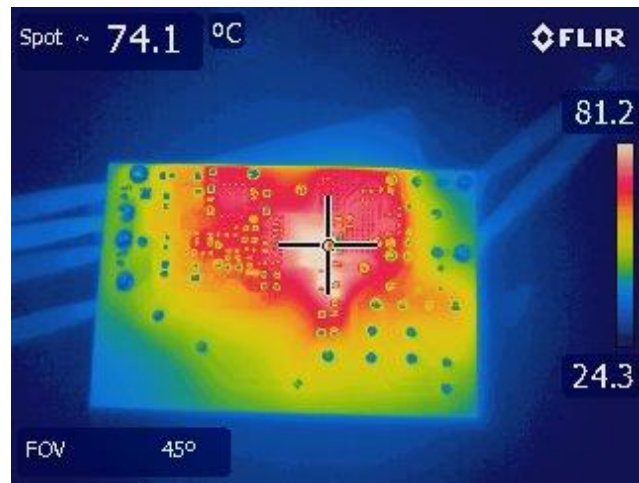

Figure 21 – InnoSwitch-EP Side. 85 VAC, Full Load.

| | Reference | °C |
|-------------------------|-----------|------|
| Ambient | | 25.5 |
| Transformer | T1 | 67 |
| Input Capacitor | C2 | 45.5 |
| Bridge Rectifier | BR1 | 62.6 |
| CMC | L1 | 55.3 |
| 12 V Choke | L5 | 59.2 |
| 12 V Capacitor | C10 | 40.8 |
| 5 V Choke | L4 | 48.4 |

| | Reference | °C |
|-------------------------|-----------|------|
| Ambient | | 26.9 |
| InnoSwitch-EP | U1 | 83 |
| SR FET Q1 | Q1 | 68 |
| SR FET Q2 | Q2 | 64 |
| Snubber Resistor | R7 | 65 |
| Clamp Resistor | R2 | 84 |

12.2 **110 VAC**

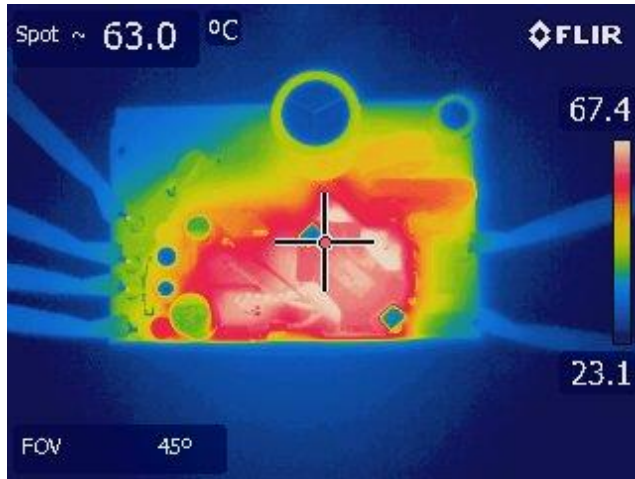

Figure 22 – Transformer Side. 110 VAC, Full Load.

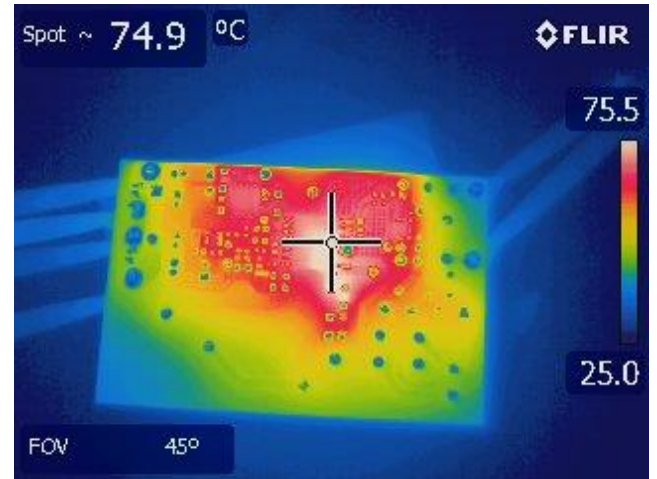

Figure 23– InnoSwitch-EP Side. 110 VAC, Full Load.

| | Reference | °C |
|-------------------------|-----------|------|
| Ambient | | 25.7 |
| Transformer | T1 | 65.8 |
| Input Capacitor | C2 | 42.6 |
| Bridge Rectifier | BR1 | 57.8 |
| CMC | L1 | 49.9 |
| 12 V Choke | L5 | 57.3 |
| 12 V Capacitor | C10 | 40.8 |
| 5 V Choke | L4 | 50 |

| | Reference | °C |
|-------------------------|-----------|------|
| Ambient | | 26.8 |
| InnoSwitch-EP | U1 | 76 |
| SR FET Q1 | Q1 | 67 |
| SR FET Q2 | Q2 | 63 |
| Snubber Resistor | R7 | 64 |
| Clamp Resistor | R2 | 78 |



12.3 230 VAC

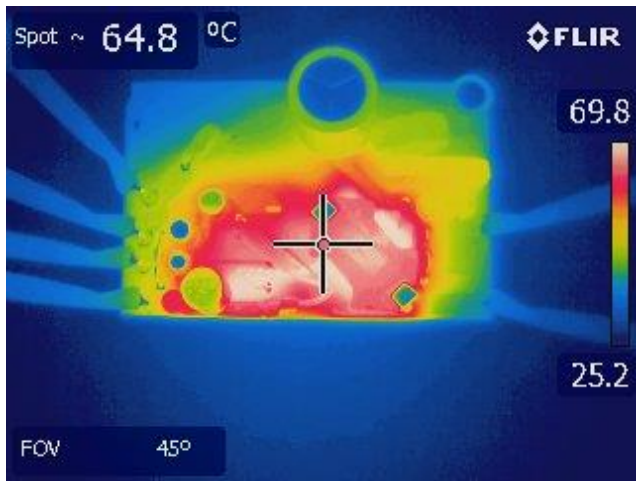

Figure 24 – Transformer Side. 230 VAC, Full Load.

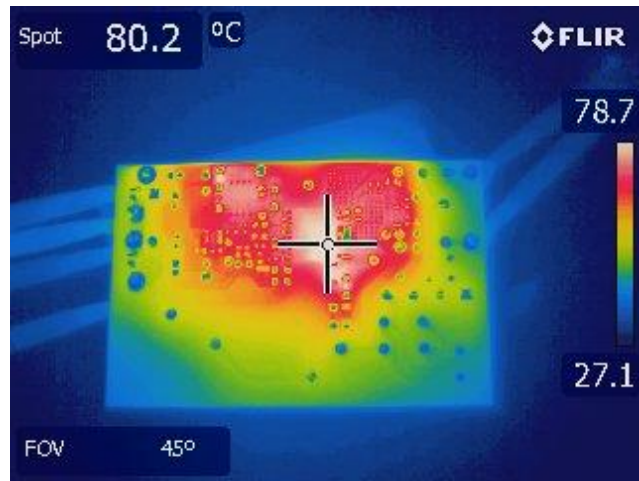

Figure 25 – InnoSwitch-EP Side. 230 VAC, Full Load.

| | Reference | °C |
|-------------------------|-----------|------|
| Ambient | | 26.3 |
| Transformer | T1 | 66.4 |
| Input Capacitor | C2 | 41 |
| Bridge Rectifier | BR1 | 46.2 |
| CMC | L1 | 41.1 |
| 12 V Choke | L5 | 61.2 |
| 12 V Capacitor | C10 | 42.4 |
| 5 V Choke | L4 | 51.6 |

| | Reference | °C |
|-------------------------|-----------|------|
| Ambient | | 26.6 |
| InnoSwitch-EP | U1 | 80.5 |
| SR FET Q1 | Q1 | 72.9 |
| SR FET Q2 | Q2 | 66.9 |
| Snubber Resistor | R7 | 71.2 |
| Clamp Resistor | R2 | 77.8 |

12.4 **265 VAC**

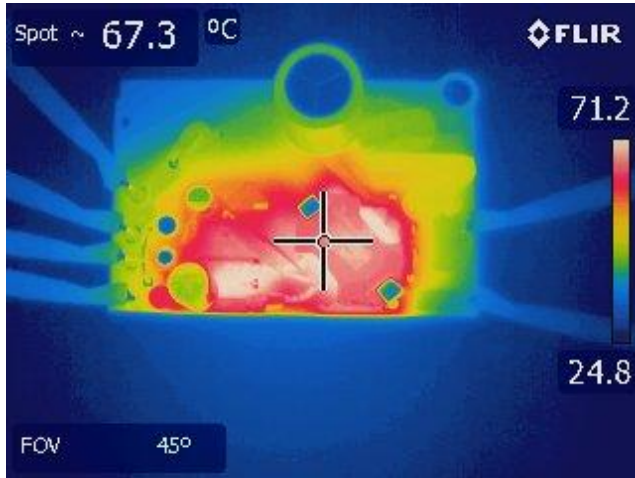

Figure 26 – Transformer Side. 265 VAC, Full Load.

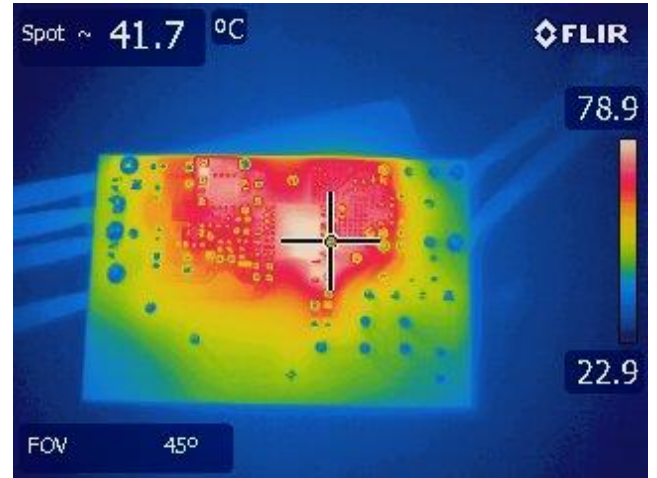

Figure 27 – InnoSwitch-EP Side. 265 VAC, Full Load.

| | Reference | °C |
|-------------------------|-----------|------|
| Ambient | | 26.3 |
| Transformer | T1 | 67.3 |
| Input Capacitor | C2 | 39.8 |
| Bridge Rectifier | BR1 | 45.5 |
| CMC | L1 | 40 |
| 12 V Choke | L5 | 61.2 |
| 12 V Capacitor | C10 | 43.3 |
| 5 V Choke | L4 | 49.5 |

| | Reference | °C |
|-------------------------|-----------|------|
| Ambient | | 26.5 |
| InnoSwitch-EP | U1 | 81.4 |
| SR FET Q1 | Q1 | 74.3 |
| SR FET Q2 | Q2 | 64.3 |
| Snubber Resistor | R7 | 70.2 |
| Clamp Resistor | R2 | 78 |

13 Waveforms

13.1 Load Transient Response

13.1.1 50% 12 V Load Transient

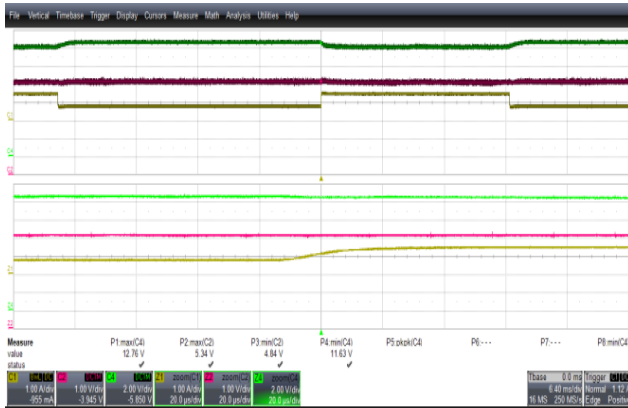

Figure 28 – 0.75 A – 1.5 A, 12 V Load Step Transient Response, 85 VAC.
 5 V_{MIN}: 4.85 V.
 5 V_{MAX}: 5.34 V.
 12 V_{MIN}: 11.63 V.
 12 V_{MAX}: 12.76 V.
 Upper: 12 V_{OUT}, 2 V / div.
 Middle: 5 V_{OUT}, 1 V / div.
 Lower: 12 V Load, 1 A, 6.4 ms, 20 μs / div.

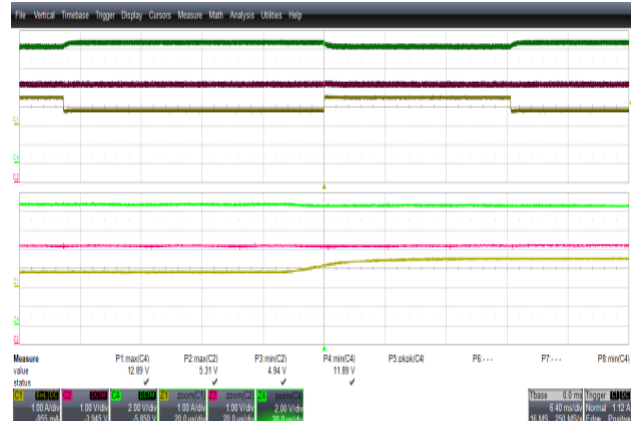

Figure 29 – 0.75 A – 1.5 A, 12 V Load Step Transient Response. 265 VAC.
 5 V_{MIN}: 4.94 V.
 5 V_{MAX}: 5.31 V.
 12 V_{MIN}: 11.89 V.
 12 V_{MAX}: 12.89 V.
 Upper: 12 V_{OUT}, 2 V / div.
 Middle: 5 V_{OUT}, 1 V / div.
 Lower: 12 V Load, 1 A, 6.4 ms, 20 μs / div.

13.2 *Switching Waveforms*

13.2.1 InnoSwitch-EP Waveforms

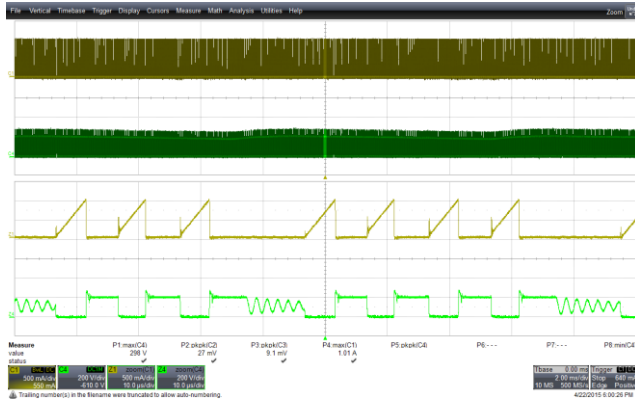

Figure 30 – Drain Voltage and Current Waveforms.
85 VAC Input, Full Load.
Lower: I_{DRAIN} , 500 mA / div.
Upper: V_{DRAIN} , 200 V, 2 ms, 10 μ s / div.



Figure 31 – Drain Voltage and Current Waveforms.
265 VAC Input, Full Load, (537 V_{MAX}).
Lower: I_{DRAIN} , 500 mA / div.
Upper: V_{DRAIN} , 200 V, 2 ms, 10 μ s / div.

13.2.2 InnoSwitch-EP Drain Voltage and Current Waveforms During Start-up and Shorted Output

Start-Up

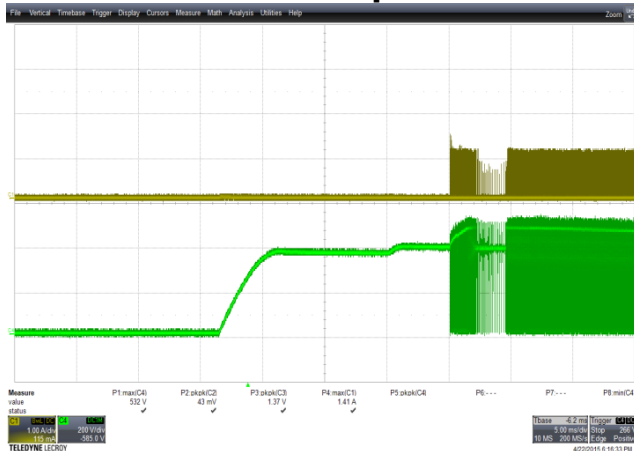

Figure 32 – Drain Voltage and Current Waveforms.
265 VAC Input, Full Load, (532 V_{MAX}).
Lower: I_{DRAIN} , 1 A / div.
Upper: V_{DRAIN} , 200 V, 5 ms / div.

Shorted Output

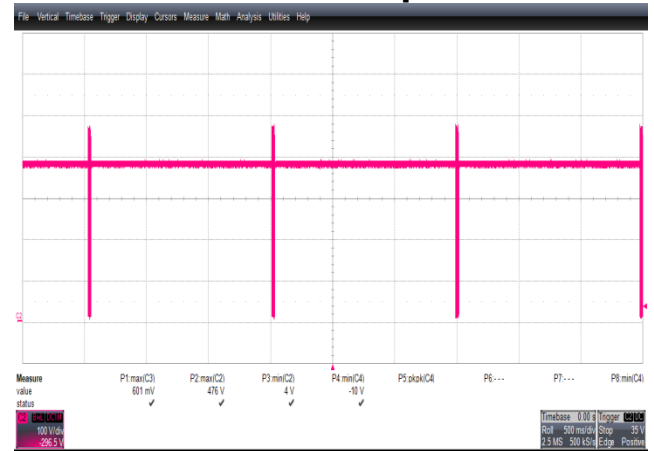

Figure 33 – Drain Voltage and Current Waveforms.
265 VAC Input, (476 V_{MAX}).
 V_{DRAIN} , 100 V, 500 ms / div.

13.2.3 SR FET Waveforms

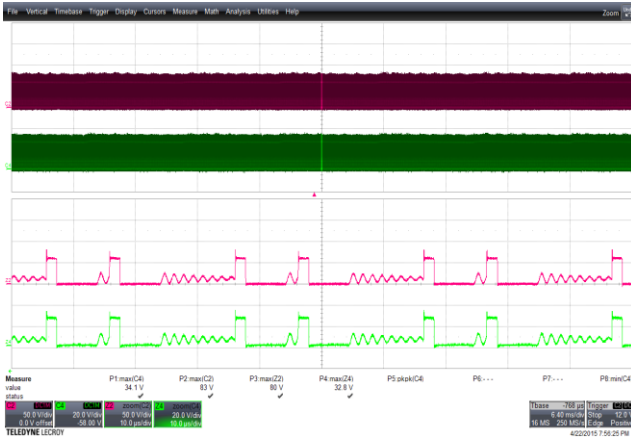

Figure 34 – SR FET Voltage Waveforms.
 265 VAC Input, Full Load.
 (83 V_{MAX} for 12 V, 34 V_{MAX} for 5 V.)
 Lower: 12 V, 50 V / div.
 Upper: 5 V, 20 V /, 6.4 ms, 10 μs / div.

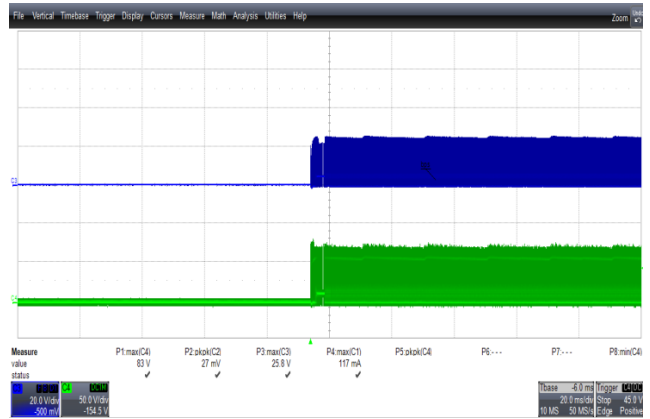

Figure 35 – SR FET Voltage Waveforms During Start-Up.
 265 VAC Input, Full Load.
 Lower: 12 V, 50 V / div.
 Upper: 5 V, 20 V /, 6.4 ms, 10 μs / div.

13.2.4 Output Voltage and Current Waveforms During Start-Up

13.2.4.1 Full load

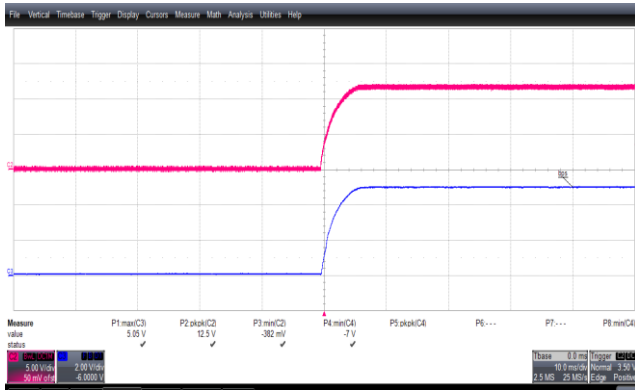

Figure 36 – Output Voltage and Current Waveforms.
85 VAC Input.
Upper: 5 V, 2 V / div.
Middle: I_{OUT} , 1 A / div.
Lower: 12 V, 5 V, 1.6 ms / div.

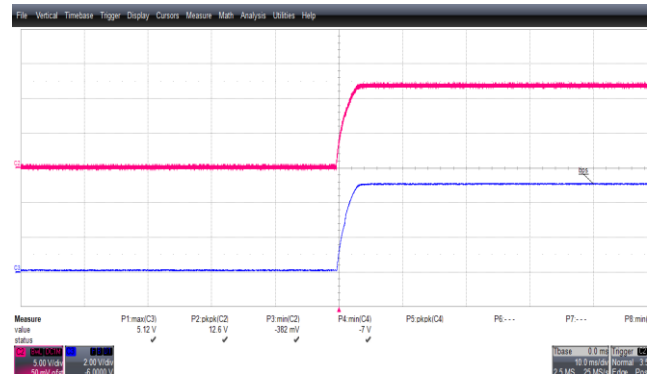

Figure 37 – Output Voltage and Current Waveforms.
265 VAC Input.
Upper: 5 V, 2 V / div.
Middle: I_{OUT} , 1 A / div.
Lower: 12 V, 5 V, 1.6 ms / div.

13.2.4.2 No-Load

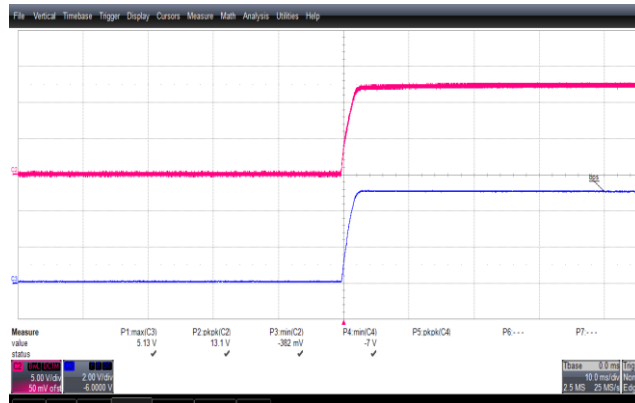

Figure 38 – Output Voltage and Current Waveforms.
85 VAC Input.
Upper: 5 V, 2 V / div.
Middle: I_{OUT} , 1 A / div.
Lower: 12 V, 5 V, 1.6 ms / div.

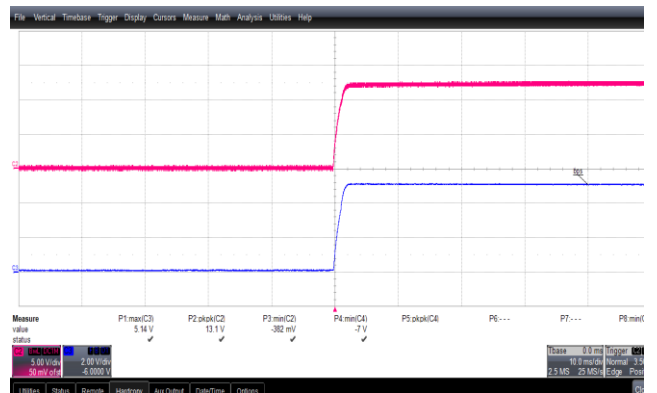

Figure 39 – Output Voltage and Current Waveforms.
265 VAC Input.
Upper: 5 V, 2 V / div.
Middle: I_{OUT} , 1 A / div.
Lower: 12 V, 5 V, 1.6 ms / div.



13.2.5 Output Voltage and Current Waveform with Shorted Output (12 V)

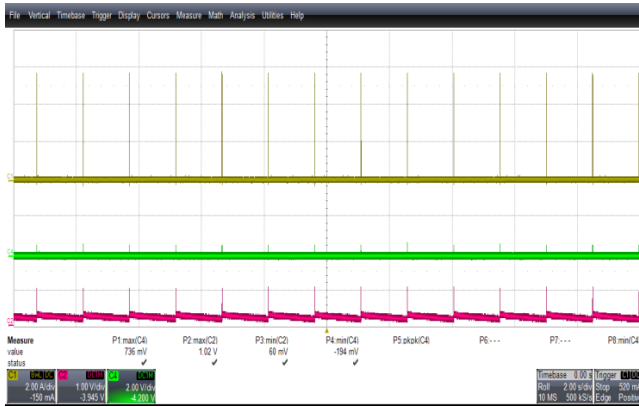

Figure 40 – Output Voltage and Current Waveforms.
 85 VAC Input.
 Upper: I_{OUT} , 2 A / div.
 Middle: 12 V, 2 V / div.
 Lower: 5 V, 1 V, 2 s / div.

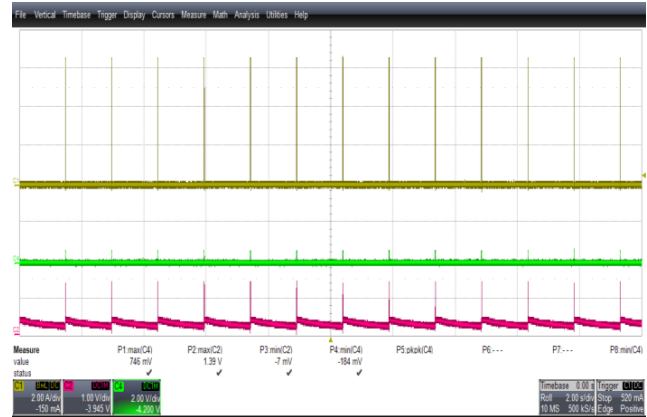

Figure 41 – Output Voltage and Current Waveforms.
 265 VAC Input.
 Upper: I_{OUT} , 2 A / div.
 Middle: 12 V, 2 V / div.
 Lower: 5 V, 1 V, 2 s / div.

13.2.6 Output Voltage and Current Waveform with Open Feedback Loop

Latched off for overvoltage protection (Loop opened while power supply was in operation)



Figure 42 – Output Voltage Waveform.
85 VAC Input.
Upper: 12 V, 10 V / div.
Lower: 5 V, 2 V / , 2 s / div.



Figure 43 – Output Voltage Waveform.
265 VAC Input.
Upper: 12 V, 10 V / div.
Lower: 5 V, 2 V / , 2 s / div.



13.3 *Output Ripple Measurements*

13.3.1 Ripple Measurement Technique

For DC output ripple measurements, a modified oscilloscope test probe must be utilized in order to reduce spurious signals due to pick-up. Details of the probe modification are provided in the Figures below.

The 4987BA probe adapter is affixed with two capacitors tied in parallel across the probe tip. The capacitors include one (1) 0.1 $\mu\text{F}/50\text{ V}$ ceramic type and one (1) 1 $\mu\text{F}/50\text{ V}$ aluminum electrolytic. The aluminum electrolytic type capacitor is polarized, so proper polarity across DC outputs must be maintained (see below).

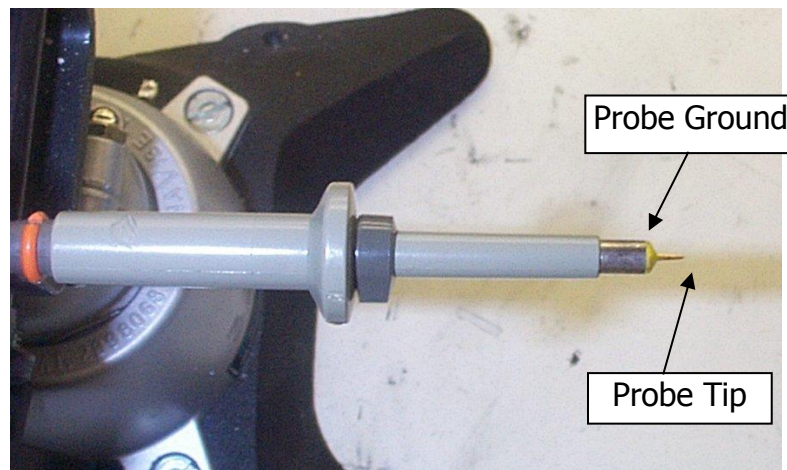

Figure 44 – Oscilloscope Probe Prepared for Ripple Measurement. (End Cap and Ground Lead Removed)



Figure 45 – Oscilloscope Probe with Probe Master (www.probemaster.com) 4987A BNC Adapter. (Modified with wires for ripple measurement, and two parallel decoupling capacitors added)

13.3.2 Ripple Voltage Waveforms

13.3.2.1 0.5 A Load on 5 V

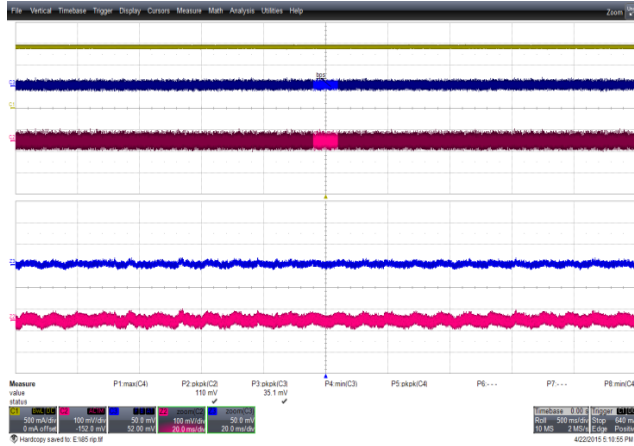

Figure 46 – Output Voltage ripple Waveforms.
 85 VAC Input. **1.5 A on 12 V.**
 5 V_{PK}: 35 mV, 12 V_{PK}: 110 mV.
 Upper: 5 V, 50 mV / div.
 Lower: 12 V, 100 mV /, 500 ms, 20 ms / div.

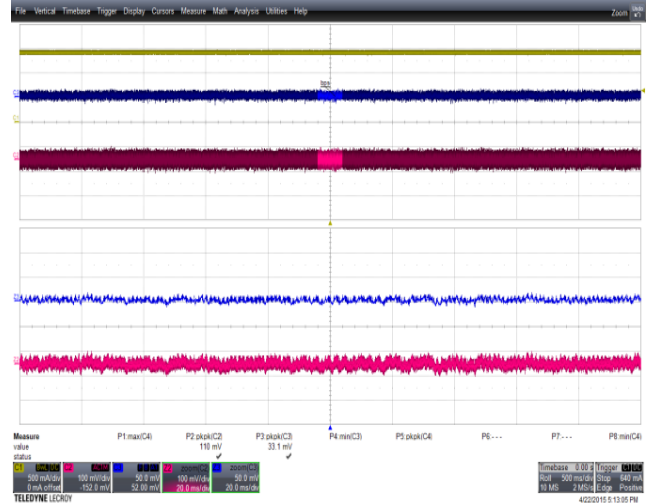

Figure 47 – Output Ripple Voltage Waveforms.
 265 VAC Input. **1.5 A on 12 V.**
 5 V_{PK}: 33 mV, 12 V_{PK}: 110 mV.
 Upper: 5 V, 50 mV / div.
 Lower: 12 V, 100 mV /, 500 ms, 20 ms / div.

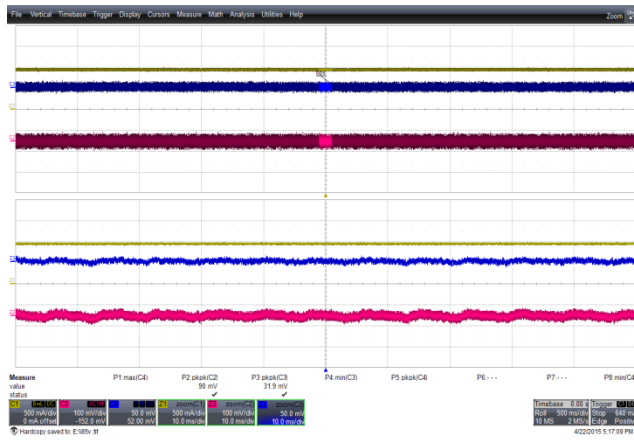

Figure 48 – Output Ripple Voltage Waveforms.
 85 VAC Input. **1.0 A on 12 V.**
 5 V_{PK}: 32 mV, 12 V_{PK}: 90 mV.
 Upper: 5 V, 50 mV / div.
 Lower: 12 V, 100 mV /, 500 ms, 20 ms / div.

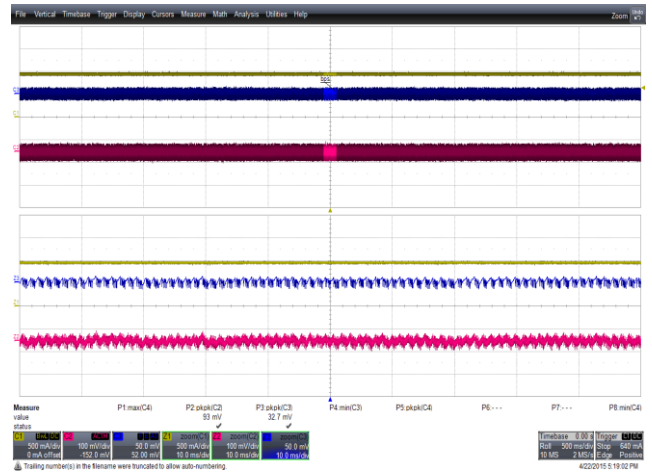

Figure 49 – Output Ripple Voltage Waveforms.
 265 VAC Input. **1.0 A on 12 V.**
 5 V_{PK}: 33 mV, 12 V_{PK}: 93 mV.
 Upper: 5 V, 50 mV / div.
 Lower: 12 V, 100 mV /, 500 ms, 20 ms / div.



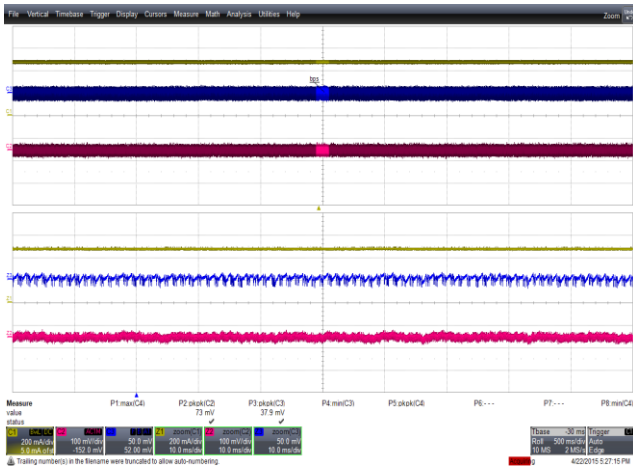

Figure 50 – Output Ripple Voltage Waveforms.
 85 VAC Input, **0.5 A on 12 V**.
 5 V_{PK}: 38 mV, 12 V_{PK}: 73 mV.
 Upper: 5 V, 50 mV / div.
 Lower: 12 V, 100 mV / , 500 ms, 20 ms / div.

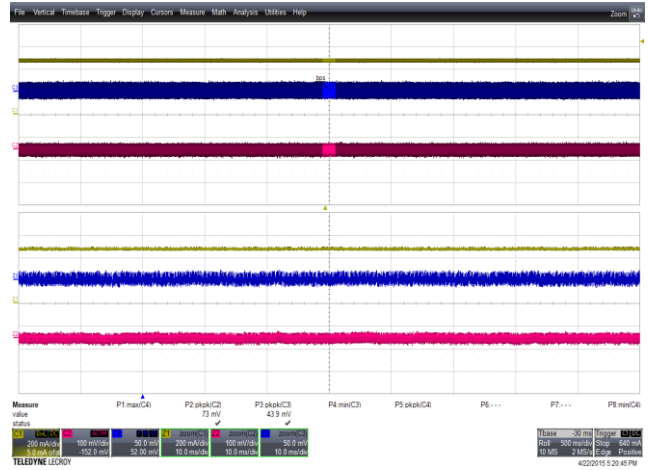

Figure 51 – Output Ripple Voltage Waveforms.
 265 VAC Input, **0.5 A on 12 V**.
 5 V_{PK}: 44 mV, 12 V_{PK}: 73 mV.
 Upper: 5 V, 50 mV / div.
 Lower: 12 V, 100 mV / , 500 ms, 20 ms / div.

13.4 **Line Undervoltage and Overvoltage (DC Input)**

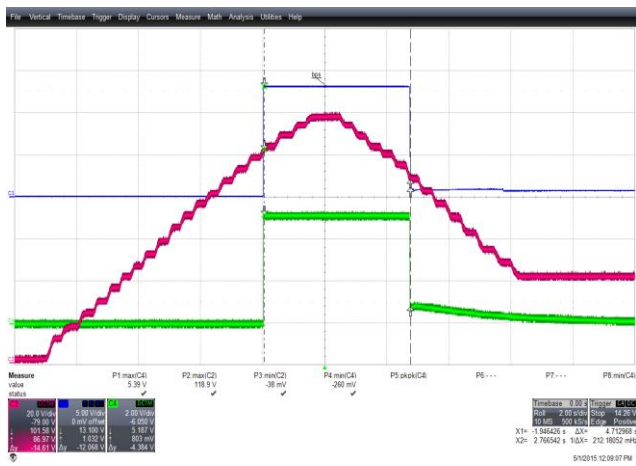

Figure 52 – Line Undervoltage.
 DC Input, No-Load.
 V_{UV+}: 101.6 V, V_{UV-}: 87 V
 Upper: 12 V, 5 V / div.
 Middle: 5 V, 2 V / div.
 Lower: Input, 20 V / , 2 s / div.

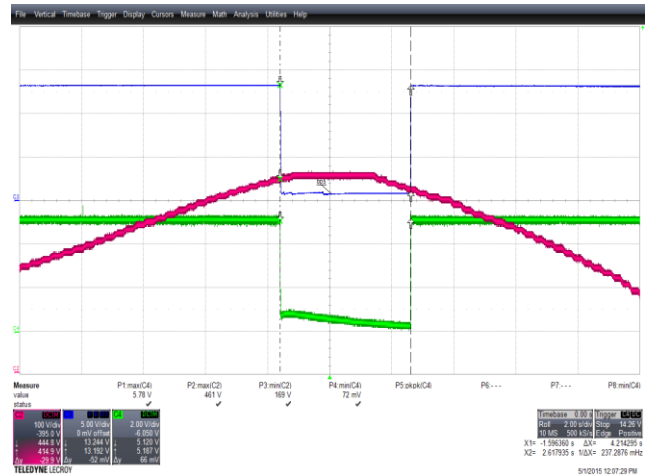

Figure 53 – Line Overvoltage.
 DC Input, No-Load.
 V_{Ov+}: 445 V, V_{Ov-}: 415 V
 Upper: 12 V, 5 V / div.
 Middle: 5 V, 2 V / div.
 Lower: Input, 100 V / , 2 s / div.



14 EMI

14.1 *Conductive EMI*

14.1.1 Floating Output (QP / AV)

14.1.1.1 110 VAC Input

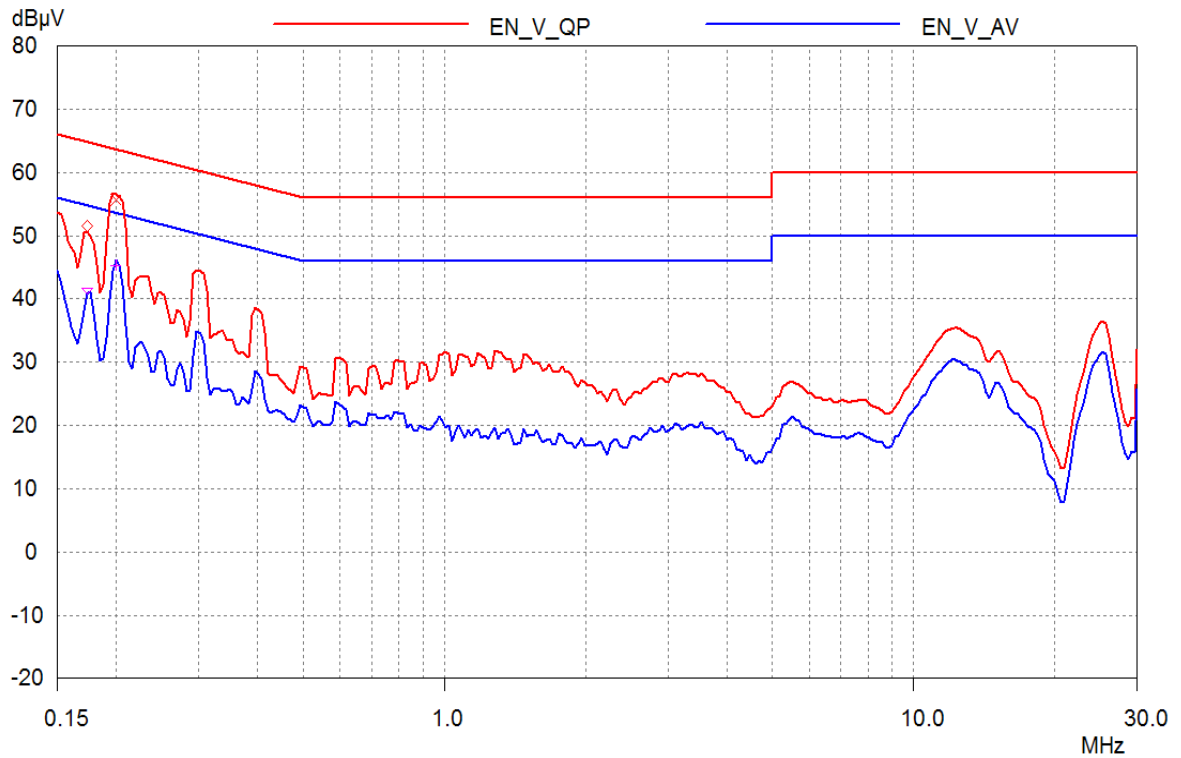

| Frequency (MHz) | QP | Limit | Margin |
|-----------------|-------|-------|--------|
| 0.20 | 55.43 | 63.63 | 8.2 |

Figure 54 – Floating Ground at 110 VAC.



14.1.1.2 230 VAC Input

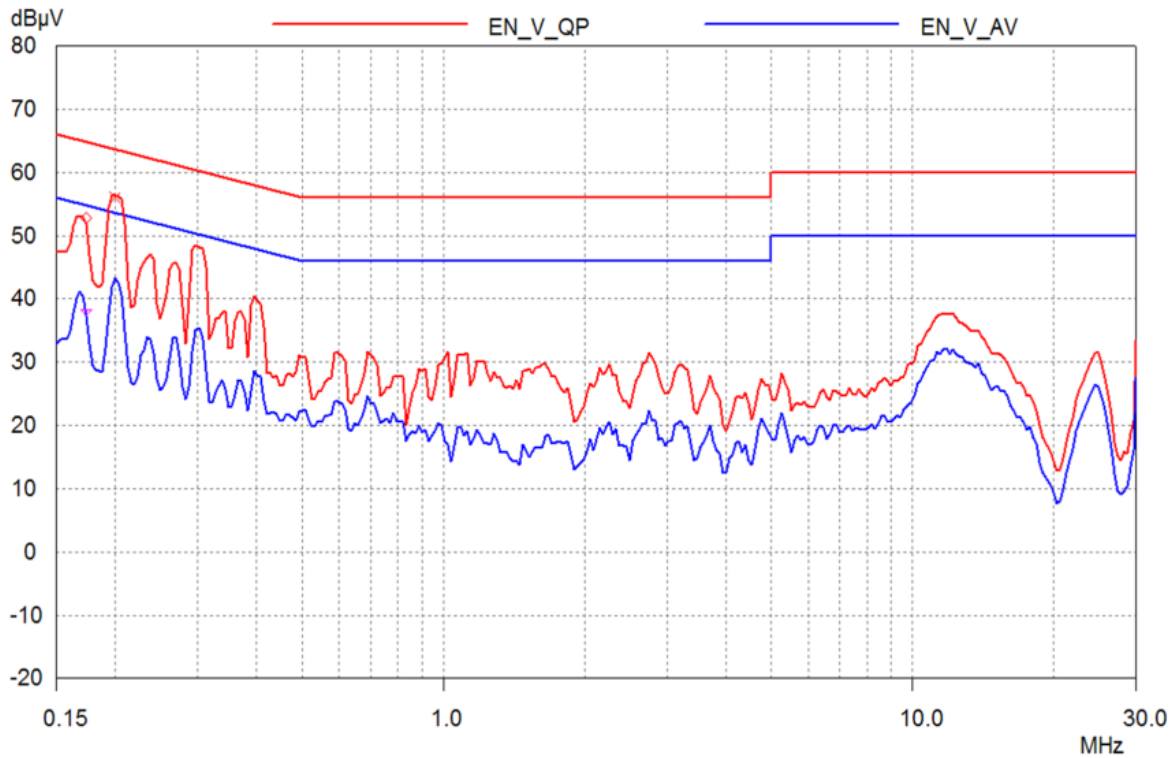

| Frequency (MHz) | QP | Limit | Margin |
|-----------------|-------|-------|--------|
| 0.20 | 56.07 | 63.63 | 7.56 |

Figure 55 – Floating Ground at 230 VAC.

14.1.2 Earth Grounded Output (QP / AV)

14.1.2.1 110 VAC Input

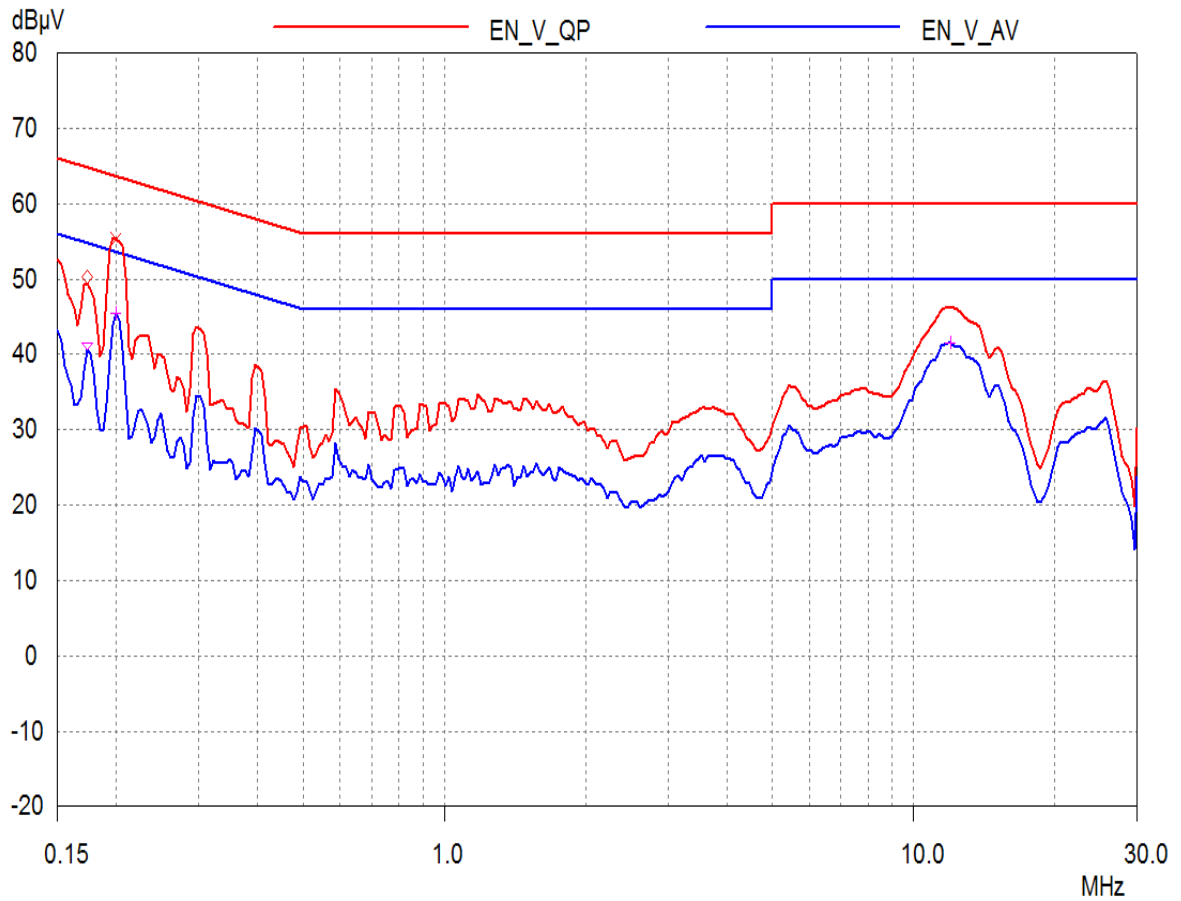

| Frequency (MHz) | QP | Limit | Margin |
|-----------------|-------|-------|--------|
| 0.20 | 55.36 | 63.63 | 8.27 |
| Frequency (MHz) | AV | Limit | Margin |
| 0.20 | 45.44 | 53.63 | 8.19 |
| 11.99 | 41.44 | 50 | 8.56 |

Figure 56 – Earth Ground at 110 VC.



14.1.2.2 230 VAC Input

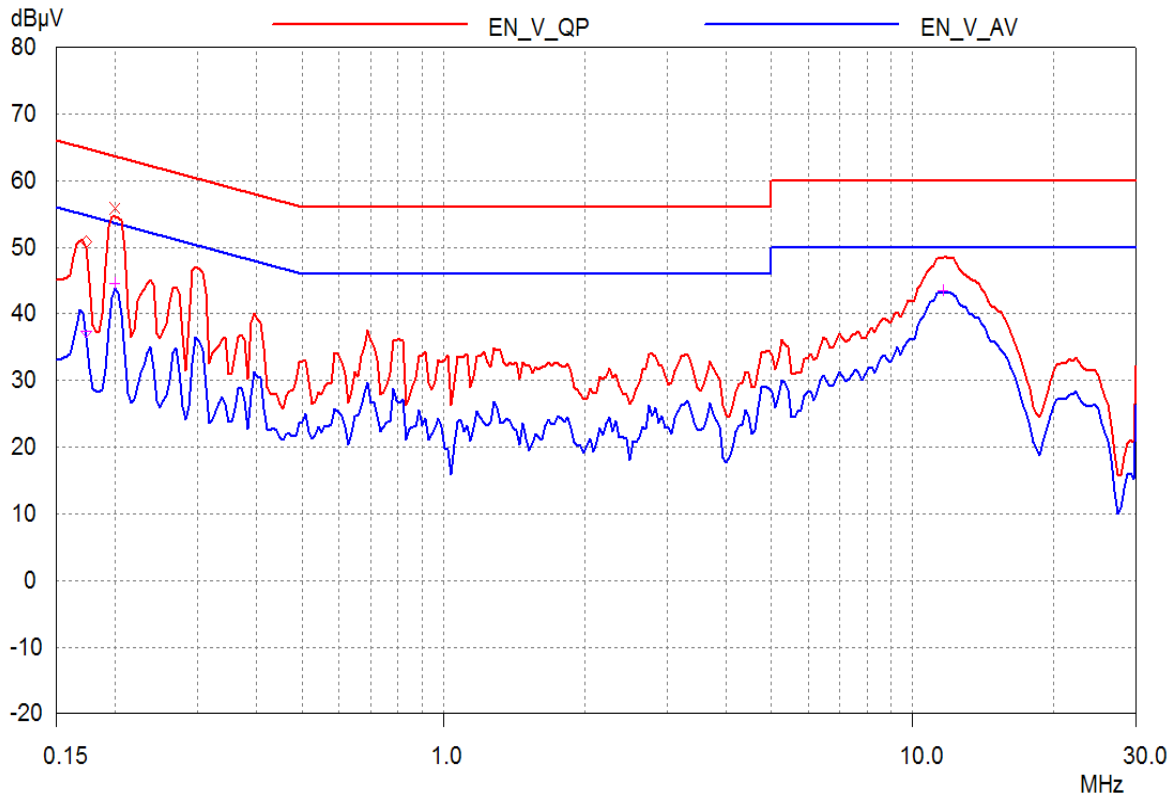

| Frequency (MHz) | QP | Limit | Margin |
|-----------------|-------|-------|--------|
| 0.20 | 55.81 | 63.63 | 7.82 |
| Frequency (MHz) | AV | Limit | Margin |
| 0.20 | 44.55 | 53.63 | 9.08 |
| 11.61 | 43.52 | 50 | 6.48 |

Figure 57 – Earth Ground at 230 VAC.

14.2 **Radiated EMI**

14.2.1 Floating Output

14.2.1.1 110 VAC Input

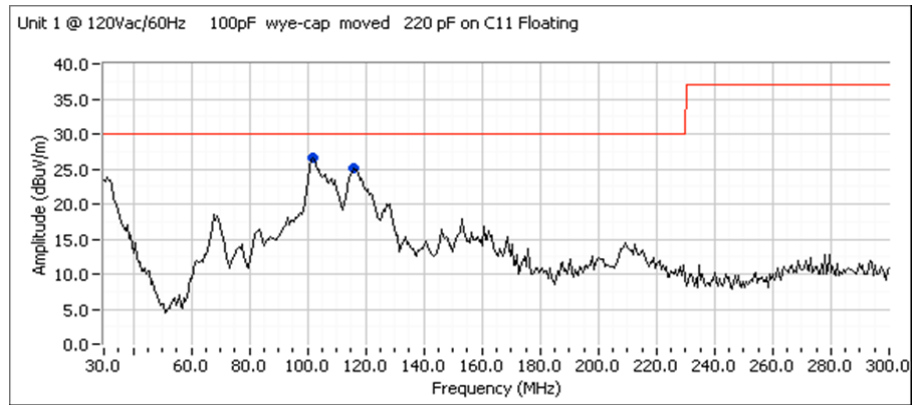

| MHz | dBuV/m | v/h | Limit | Margin | Pk/QP/Avg | degrees | meters |
|---------|--------|-----|-------|--------|-----------|---------|--------|
| 116.032 | 22.5 | V | 30.0 | -7.5 | QP | 34 | 1.0 |
| 101.964 | 19.1 | V | 30.0 | -10.9 | QP | 238 | 1.0 |
| 101.964 | 26.6 | V | 30.0 | -3.4 | Peak | 224 | 1.0 |

Figure 58 – Floating Ground at 110 VAC.

14.2.1.2 230 VAC Input

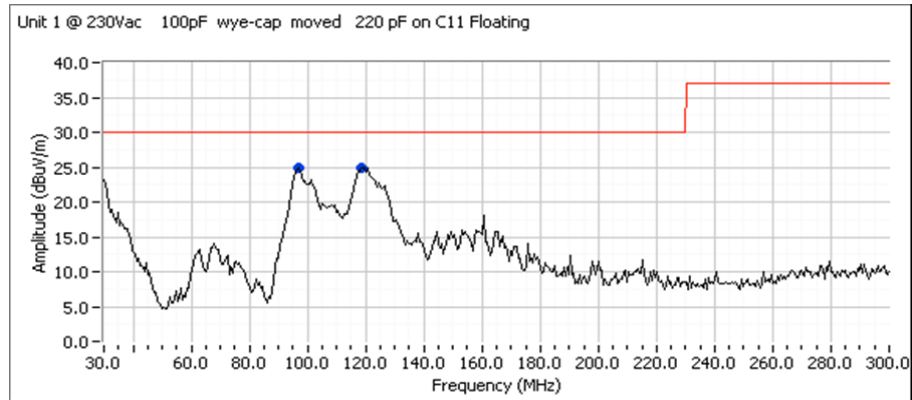

| MHz | dBuV/m | v/h | Limit | Margin | Pk/QP/Avg | degrees | meters |
|---------|--------|-----|-------|--------|-----------|---------|--------|
| 118.634 | 21.6 | V | 30.0 | -8.4 | QP | 280 | 1.0 |
| 96.602 | 21.3 | V | 30.0 | -8.7 | QP | 49 | 1.0 |
| 97.094 | 24.8 | V | 30.0 | -5.2 | Peak | 61 | 1.0 |
| 118.737 | 25.0 | V | 30.0 | -5.0 | Peak | 273 | 1.0 |

Figure 59 – Floating Ground at 230 VAC.



14.2.2 Earth Grounded Output

14.2.2.1 110 VAC Input

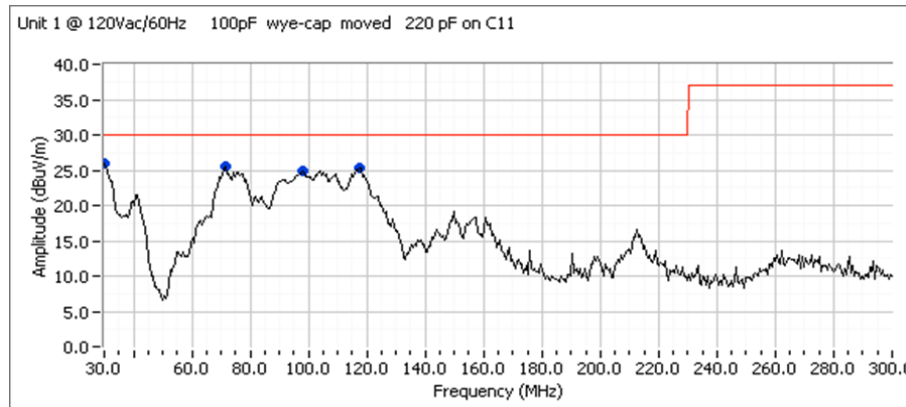

| MHz | dB μ V/m | v/h | Limit | Margin | Pk/QP/Avg | degrees | meters |
|---------|--------------|-----|-------|--------|-----------|---------|--------|
| 71.663 | 25.5 | V | 30.0 | -4.5 | Peak | 256 | 1.0 |
| 118.196 | 25.3 | V | 30.0 | -4.7 | Peak | 31 | 1.0 |
| 98.176 | 24.9 | V | 30.0 | -5.1 | Peak | 126 | 1.0 |

Figure 60 – Earth Ground at 110 VAC.

14.2.2.2 230 VAC Input

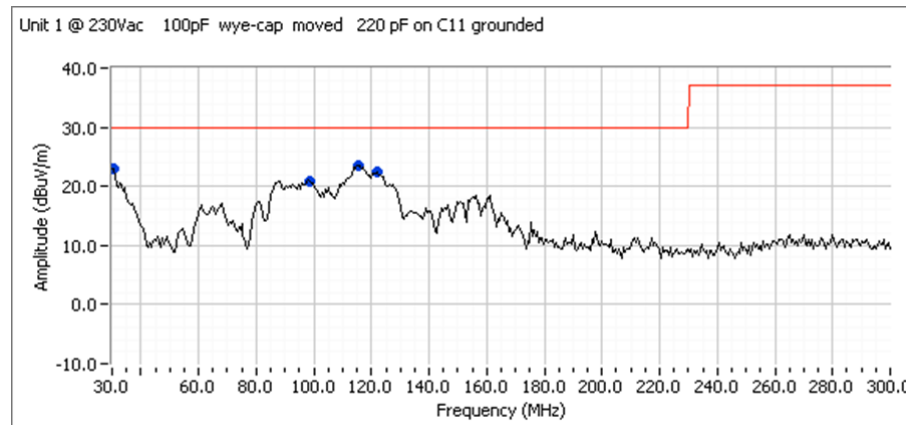

| MHz | dB μ V/m | v/h | Limit | Margin | Pk/QP/Avg | degrees | meters |
|---------|--------------|-----|-------|--------|-----------|---------|--------|
| 71.663 | 25.5 | V | 30.0 | -4.5 | Peak | 256 | 1.0 |
| 118.196 | 25.3 | V | 30.0 | -4.7 | Peak | 31 | 1.0 |
| 98.176 | 24.9 | V | 30.0 | -5.1 | Peak | 126 | 1.0 |

Figure 61 – Earth Ground at 230 VAC.

15 Lighting Surge Test

15.1 *Differential Mode Test*

Passed ± 1 kV, 500 A surge test.

| Surge Voltage (kV) | Phase Angle (°) | Generator Impedance (W) | Number of Strikes | Test Result |
|--------------------|-----------------|-------------------------|-------------------|-------------|
| 1 | 90 | 2 | 10 | PASS |
| 1 | 270 | 2 | 10 | PASS |

15.2 *Common Mode Test*

Passed ± 6 kV, 500 A ring wave test

| Ring Wave Voltage (kV) | Phase Angle (°) | Generator Impedance (W) | Number of Strikes | Test Result |
|------------------------|-----------------|-------------------------|-------------------|-------------|
| 6 | 90 | 12 | 10 | PASS |
| -6 | 90 | 12 | 10 | PASS |
| 6 | 270 | 12 | 10 | PASS |
| -6 | 270 | 12 | 10 | PASS |

16 Revision History

| Date | Author | Revision | Description & Changes | Reviewed |
|-----------|--------|----------|--|-------------|
| 15-Sep-15 | DK | 1.0 | Initial Release | Apps & Mktg |
| 30-Oct-15 | DK | 1.1 | Updated No-Load Graph and Photographs of Assembled Boards. Added Magnetics Source. | |
| 22-Dec-15 | DK | 1.2 | Updated Transformer Information and Figure 13. | |
| 04-Feb-16 | KM | 1.3 | Updated Figure 53 Caption | |



For the latest updates, visit our website: www.power.com

Power Integrations reserves the right to make changes to its products at any time to improve reliability or manufacturability. Power Integrations does not assume any liability arising from the use of any device or circuit described herein. POWER INTEGRATIONS MAKES NO WARRANTY HEREIN AND SPECIFICALLY DISCLAIMS ALL WARRANTIES INCLUDING, WITHOUT LIMITATION, THE IMPLIED WARRANTIES OF MERCHANTABILITY, FITNESS FOR A PARTICULAR PURPOSE, AND NON-INFRINGEMENT OF THIRD PARTY RIGHTS.

Patent Information

The products and applications illustrated herein (including transformer construction and circuits' external to the products) may be covered by one or more U.S. and foreign patents, or potentially by pending U.S. and foreign patent applications assigned to Power Integrations. A complete list of Power Integrations' patents may be found at www.power.com. Power Integrations grants its customers a license under certain patent rights as set forth at <http://www.power.com/ip.htm>.

The PI Logo, TOPSwitch, TinySwitch, LinkSwitch, LYTSwitch, InnoSwitch, DPA-Switch, PeakSwitch, CAPZero, SENZero, LinkZero, HiperPFS, HiperTFS, HiperLCS, Qspeed, EcoSmart, Clampless, E-Shield, Filterfuse, FluxLink, StackFET, PI Expert and PI FACTS are trademarks of Power Integrations, Inc. Other trademarks are property of their respective companies. ©Copyright 2015 Power Integrations, Inc.

Power Integrations Worldwide Sales Support Locations**WORLD HEADQUARTERS**

5245 Hellyer Avenue
San Jose, CA 95138, USA.
Main: +1-408-414-9200
Customer Service:
Phone: +1-408-414-9665
Fax: +1-408-414-9765
e-mail: usasales@power.com

GERMANY

Lindwurmstrasse 114
80337, Munich
Germany
Phone: +49-895-527-39110
Fax: +49-895-527-39200
e-mail: eurosales@power.com

JAPAN

Kosei Dai-3 Building
2-12-11, Shin-Yokohama,
Kohoku-ku, Yokohama-shi,
Kanagawa 222-0033
Japan
Phone: +81-45-471-1021
Fax: +81-45-471-3717
e-mail: japansales@power.com

TAIWAN

5F, No. 318, Nei Hu Rd.,
Sec. 1
Nei Hu District
Taipei 11493, Taiwan R.O.C.
Phone: +886-2-2659-4570
Fax: +886-2-2659-4550
e-mail:
taiwansales@power.com

CHINA (SHANGHAI)

Rm 2410, Charity Plaza, No. 88,
North Caoxi Road,
Shanghai, PRC 200030
Phone: +86-21-6354-6323
Fax: +86-21-6354-6325
e-mail: chinasales@power.com

INDIA

#1, 14th Main Road
Vasanthanagar
Bangalore-560052
India
Phone: +91-80-4113-8020
Fax: +91-80-4113-8023
e-mail: indiasales@power.com

KOREA

RM 602, 6FL
Korea City Air Terminal B/D,
159-6
Samsung-Dong, Kangnam-Gu,
Seoul, 135-728 Korea
Phone: +82-2-2016-6610
Fax: +82-2-2016-6630
e-mail: koreasales@power.com

UK

Cambridge Semiconductor,
a Power Integrations company
Westbrook Centre, Block 5,
2nd Floor
Milton Road
Cambridge CB4 1YG
Phone: +44 (0) 1223-446483
e-mail: eurosales@power.com

CHINA (SHENZHEN)

17/F, Hivac Building, No. 2, Keji
Nan 8th Road, Nanshan District,
Shenzhen, China, 518057
Phone: +86-755-8672-8689
Fax: +86-755-8672-8690
e-mail: chinasales@power.com

ITALY

Via Milanese 20, 3rd. Fl.
20099 Sesto San Giovanni (MI)
Italy
Phone: +39-024-550-8701
Fax: +39-028-928-6009
e-mail: eurosales@power.com

SINGAPORE

51 Newton Road,
#19-01/05 Goldhill Plaza
Singapore, 308900
Phone: +65-6358-2160
Fax: +65-6358-2015
e-mail: singaporesales@power.com





Компания «ЭлектроПласт» предлагает заключение долгосрочных отношений при поставках импортных электронных компонентов на взаимовыгодных условиях!

Наши преимущества:

- Оперативные поставки широкого спектра электронных компонентов отечественного и импортного производства напрямую от производителей и с крупнейших мировых складов;
- Поставка более 17-ти миллионов наименований электронных компонентов;
- Поставка сложных, дефицитных, либо снятых с производства позиций;
- Оперативные сроки поставки под заказ (от 5 рабочих дней);
- Экспресс доставка в любую точку России;
- Техническая поддержка проекта, помощь в подборе аналогов, поставка прототипов;
- Система менеджмента качества сертифицирована по Международному стандарту ISO 9001;
- Лицензия ФСБ на осуществление работ с использованием сведений, составляющих государственную тайну;
- Поставка специализированных компонентов (Xilinx, Altera, Analog Devices, Intersil, Interpoint, Microsemi, Aeroflex, Peregrine, Syfer, Eurofarad, Texas Instrument, Miteq, Cobham, E2V, MA-COM, Hittite, Mini-Circuits, General Dynamics и др.);

Помимо этого, одним из направлений компании «ЭлектроПласт» является направление «Источники питания». Мы предлагаем Вам помощь Конструкторского отдела:

- Подбор оптимального решения, техническое обоснование при выборе компонента;
- Подбор аналогов;
- Консультации по применению компонента;
- Поставка образцов и прототипов;
- Техническая поддержка проекта;
- Защита от снятия компонента с производства.



Как с нами связаться

Телефон: 8 (812) 309 58 32 (многоканальный)

Факс: 8 (812) 320-02-42

Электронная почта: org@eplast1.ru

Адрес: 198099, г. Санкт-Петербург, ул. Калинина, дом 2, корпус 4, литера А.