



MAX9994 Evaluation Kit

Evaluates: MAX9994

General Description

The MAX9994 evaluation kit (EV kit) simplifies the evaluation of the MAX9994 UMTS, DCS, and PCS base-station downconversion mixer. It is fully assembled and tested at the factory. Standard 50Ω SMA connectors are included on the EV kit's input and output ports to allow quick and easy evaluation on the test bench.

This document provides a list of test equipment required to evaluate the device, a straightforward test procedure to verify functionality, a description of the EV kit circuit, the circuit schematic, a bill of materials (BOM) for the kit, and artwork for each layer of the PC board.

Contact MaximDirect sales at 888-629-4642 for pricing and availability on these kits.

Features

- ◆ Fully Assembled and Tested
- ◆ 1700MHz to 2200MHz RF Frequency
- ◆ 1400MHz to 2000MHz LO Frequency
- ◆ 40MHz to 350MHz IF Frequency
- ◆ 8.3dB Conversion Gain
- ◆ 26.2dBm IIP3
- ◆ 9.7dB Noise Figure
- ◆ Integrated LO Buffer
- ◆ Switch-Selectable (SPDT), Two LO Inputs
- ◆ -3dBm to +3dBm LO Drive
- ◆ 45dB LO1 to LO2 Isolation
- ◆ 50Ω SMA Connectors on Input and Output Ports
- ◆ 4:1 Balun for Single-Ended IF Output

Ordering Information

PART	TEMP RANGE	PIN-PACKAGE
MAX9994EVKIT	T _C = -40°C to +85°C**	20 Thin QFN-EP*

*EP = Exposed paddle.

**T_C = Case temperature.

Component List

DESIGNATION	QTY	DESCRIPTION
C1	1	4.0pF ±0.25pF, 50V C0G ceramic capacitor (0603) Murata GRM1885C1H4R0C
C2, C6, C7, C8, C10, C12	6	22pF ±5%, 50V C0G ceramic capacitors (0603) Murata GRM1885C1H220J
C3, C5, C9, C11	4	0.01μF ±10%, 50V X7R ceramic capacitors (0603) Murata GRM188R71H103K
C4	1	10pF ±5%, 50V C0G ceramic capacitor (0603) Murata GRM1885C1H100J
C13, C14	2	150pF ±5%, 50V C0G ceramic capacitors (0603) Murata GRM1885C1H151J

DESIGNATION	QTY	DESCRIPTION
C15	1	150pF ±5%, 50V C0G ceramic capacitor (0402) Murata GRP1555C1H151J
J1, J2, J3, J4	4	PC board edge-mount SMA RF connectors (flat-tab launch) Johnson 142-0741-856
L1, L2	2	470nH ±5% wire-wound inductors (0805) Coilcraft 0805CS-471XJBC
L3	1	10nH ±5% wire-wound inductor (0603) Coilcraft 0603CS-10NXJBC
R1	1	806Ω±1% resistor (0603) Any

MAX9994 Evaluation Kit

Component List (continued)

DESIGNATION	QTY	DESCRIPTION
R2	1	549Ω ±1% resistor (0603) Any
R3	1	7.15Ω ±1% resistor (1206) Digi-Key 311-7.15FCT-ND
R4	1	47kΩ ±5% resistor (0603)
T1	1	4:1 transformer (200:50) Mini Circuits TC4-1W-7A
TP1	1	Large test point for 0.062in PC board (red) Mouser 151-107 or equivalent
TP2	1	Large test point for 0.062in PC board (black) Mouser 151-103 or equivalent
TP3	1	Large test point for 0.062in PC board (white) Mouser 151-101 or equivalent
U1	1	Active mixer IC (5mm x 5mm, 20-pin QFN, EP) Maxim MAX9994ETP NOTE: U1 HAS AN EXPOSED PADDLE CONDUCTOR THAT REQUIRES IT TO BE SOLDER ATTACHED TO A GROUNDED PAD ON THE CIRCUIT BOARD TO ENSURE A PROPER ELECTRICAL/THERMAL DESIGN.

Quick Start

The MAX9994 EV kit is fully assembled and factory tested. Follow the instructions in the *Connections and Setup* section for proper device evaluation.

Test Equipment Required

This section lists the recommended test equipment to verify the operation of the MAX9994. It is intended as a guide only, and substitutions may be possible:

- One DC supply capable of delivering +5.0V and 300mA
- Two RF signal generators capable of delivering 10dBm of output power in the 1GHz to 3GHz frequency range (i.e., HP 8648)
- One RF spectrum analyzer with a minimum 100kHz to 3GHz frequency range (HP 8561E)

- One RF power meter (HP 437B)
- One power sensor (HP 8482A)

Connections and Setup

This section provides a step-by-step guide to testing the basic functionality of the EV kit. As a general precaution to prevent damaging the outputs by driving high-VSWR loads, **do not turn on DC power or RF signal generators until all connections are made.**

This procedure is specific to operation in the U.S. PCS band (reverse channel: 1850MHz to 1910MHz), low-side injected LO for a 200MHz IF. Choose the test frequency based on the particular system's frequency plan, and adjust the following procedure accordingly. See Figure 1 for the mixer test setup diagram:

- 1) Calibrate the power meter for 1700MHz. For safety margin, use a power sensor rated to at least +20dBm, or use padding to protect the power head as necessary.
- 2) Connect 3dB pads to the DUT ends of each of the two RF signal generators' SMA cables. This padding improves VSWR and reduces the errors due to mismatch.
- 3) Use the power meter to set the RF signal generators according to the following:
 - RF signal source: -5dBm into DUT at 1900MHz (this will be about -2dBm before the 3dB pad).
 - LO1 signal source: 0dBm into DUT at 1700MHz (this will be about 3dBm before the 3dB pad).
 - LO2 signal source: 0dBm into DUT at 1701MHz (this will be about 3dBm before the 3dB pad).
- 4) Disable the signal generator outputs.
- 5) Connect the RF source (with pad) to RFIN.
- 6) Connect the LO1 and LO2 signal sources to the EV kits LO1 and LO2 inputs, respectively.
- 7) Measure loss in 3dB pad and cable that will be connected to IFOUT. Losses are frequency dependent, so test this at 200MHz (the IF frequency). Use this loss as an offset in all output power/gain calculations.
- 8) Connect this 3dB pad to the EV kit's IFOUT connector and connect a cable from the pad to the spectrum analyzer.
- 9) Set DC supply to +5.0V, and set a current limit of

MAX9994 Evaluation Kit

approximately 300mA, if possible. Disable the output voltage and connect the supply to the EV kit (through an ammeter, if desired). Enable the supply. Readjust the supply to get +5.0V at the EV kit. There will be a voltage drop across the ammeter when the mixer is drawing current.

- 10) Select LO1 by connecting LOSEL (TP3) to GND.
- 11) Enable the LO and the RF sources.

Testing the Mixer

Adjust the center and span of the spectrum analyzer to observe the IF output tone at 200MHz. The level should be about +0.3dBm (8.3dB conversion gain, 3dB pad loss). There is also a tone at 199MHz, which is due to the LO signal applied to LO2. The amount of suppression between the 200MHz and 199MHz signals is the LO switch isolation. Note that the spectrum analyzer's absolute magnitude accuracy is typically no better than ± 1 dB. If accuracy is required, use the power meter to measure the absolute single-tone power level.

Disconnect the GND connection to LOSEL. It is pulled high by a pullup resistor on the board, selecting LO2. Observe that the 199MHz signal increases while the 200MHz decreases. Reconfigure the test setup using a combiner or hybrid to apply two RF signals at RFIN to do a two-tone IP3 measurement, if desired. Terminate the unused LO input in 50 Ω .

Detailed Description

The MAX9994 is a high-linearity downconverter integrated with RF and LO baluns, an LO buffer, an IF amplifier, and an SPDT LO input select switch. The EV kit circuit consists mostly of supply-decoupling capacitors, DC-blocking capacitors, an IF balun, and inductive chokes. The MAX9994 EV kit circuit allows for thorough analysis and a simple design-in.

Supply-Decoupling Capacitors

Capacitors C2, C6, C7, and C8 are 22pF supply-decoupling capacitors used to filter high-frequency noise. Capacitors C3, C9, and C11 are larger 0.01 μ F used for filtering lower frequency noise on the supply.

DC-Blocking Capacitors

The MAX9994 has internal baluns at the RF and LO inputs. These inputs have almost 0 Ω resistance at DC, and so DC-blocking capacitors C1, C10, and C12 are used to prevent any external bias from being shunted directly to ground.

LO Bias and IF Bias

Bias currents for the integrated IF amplifier and the LO buffer are set with resistors R1 (806 Ω , $\pm 1\%$) and R2

(549 Ω , $\pm 1\%$), respectively. These values were carefully chosen during factory testing for optimum linearity and minimal supply current.

Current-Limiting Resistors

Resistor R3 is used for current limiting at the supply. Resistor R3 typically dissipates 60mW.

Tap Network

Capacitor C5 helps to terminate the second-order intermodulation products.

LEXT

The 10nH wire-wound inductor, L3, improves LO-to-IF and RF-to-IF isolation. If isolation is not critical, then this pin can be grounded.

IF \pm

The MAX9994 employs a differential IF output to offer increased IP2 system performance. The EV kit uses a 4:1 balun to transform the 200 Ω differential output impedance to a 50 Ω single-ended output for easy bench evaluation. Inductive chokes L1 and L2 provide DC bias to the IF output amplifier, C13 and C14 for supply filtering, and R3 for current limiting.

As the differential IF outputs are relatively high impedance (200 Ω), they are more susceptible to component parasitics. It is often good practice to relieve the ground plane directly underneath large components to reduce associated shunt-C parasitics.

LOSEL

The EV kit includes a 47k Ω pullup resistor for easy selection of the LO port. Providing a ground at TP3 selects LO1, and leaving TP3 open selects LO2. To drive TP3 from an external source, follow the limits called out in the MAX9994 device data sheet. Logic voltages should not be applied to LOSEL without the +5V supply voltage. Doing so can cause the on-chip ESD diodes to conduct and could damage the device.

Layout Considerations

The MAX9994 evaluation board can be a guide for your board layout. Pay close attention to thermal design and close placement of components to the IC. The MAX9994 package exposed paddle (EP) conducts heat from the device and provides a low-impedance electrical connection to the ground plane. The EP **MUST** be attached to the PC board ground plane with a low-thermal and electrical impedance contact. Ideally, this is achieved by soldering the backside of the package directly to a top metal ground plane on the PC board. Alternatively, the EP can be connected to an internal or bottom-side ground plane using an array of plated vias directly below

MAX9994 Evaluation Kit

the EP. The MAX9994EV kit uses nine evenly spaced, 0.016in-diameter, plated through holes to connect the EP to the lower ground planes.

Depending on the ground-plane spacing, large surface-mount pads in the IF path may need to have the ground plane relieved under them to reduce parasitic shunt capacitance.

Modifying the EV Kit

The RF and LO inputs are broadband matched, so there is no need to modify the circuit for use anywhere in the 1700MHz to 2200MHz RF range (1400MHz to 2000MHz LO range).

Retuning for a different IF is as simple as scaling the values of the IF pullup inductors up or down with frequency. The IF output looks like 200Ω differential in parallel with a capacitor. The capacitance is due to the combination of the IC, PC board, and external IF components. The capacitance from the IC is approximately 2pF to ground (1pF differential) while that from the PC

board and external components is approximately 0.75pF to ground. The total 2.75pF of capacitance is resonated out at the frequency of interest by bias inductors L1 and L2. To determine the inductor value use the following equation:

$$f_{IF} = \frac{1}{2\pi\sqrt{LC}}$$

The IF output is tuned for operation at approximately 140MHz, so a 470nH inductor is used. For lower IF frequency (i.e., larger component values), maintain the component's Q value at the cost of larger case size, unless it is unavoidable.

Component Suppliers

SUPPLIER	PHONE	WEBSITE
Coilcraft	800-322-2645	www.coilcraft.com
Digi-Key	800-344-4539	www.digikey.com
Johnson	507-833-8822	www.johnsoncomponents.com
Mini-Circuits	718-934-4500	www.minicircuits.com
Murata	770-436-1300	www.murata.com

Note: Indicate that you are using the MAX9994 when contacting these component suppliers.

MAX9994 Evaluation Kit

Evaluates: MAX9994

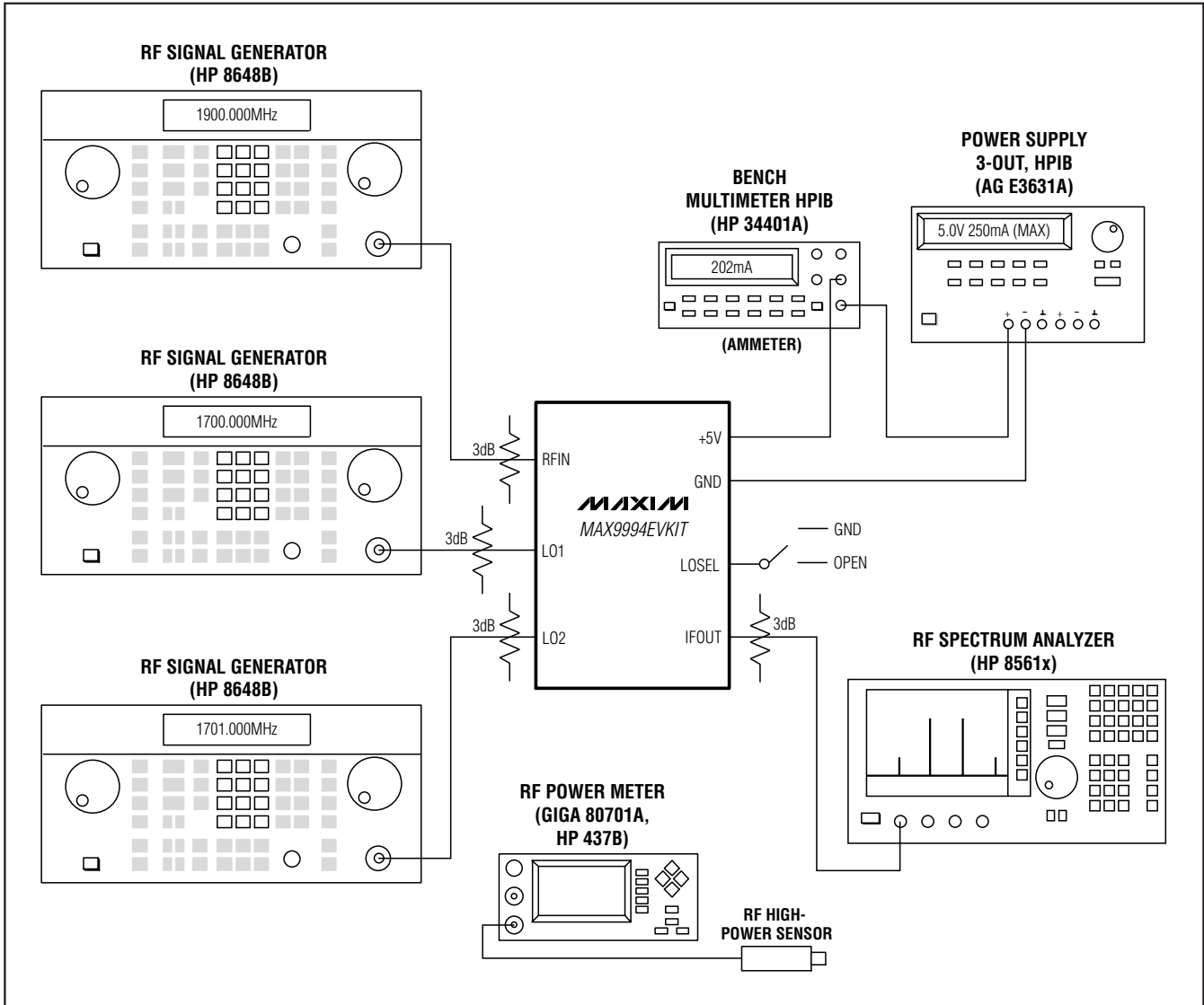

Figure 1. Test Setup Diagram

MAX9994 Evaluation Kit

Evaluates: MAX9994

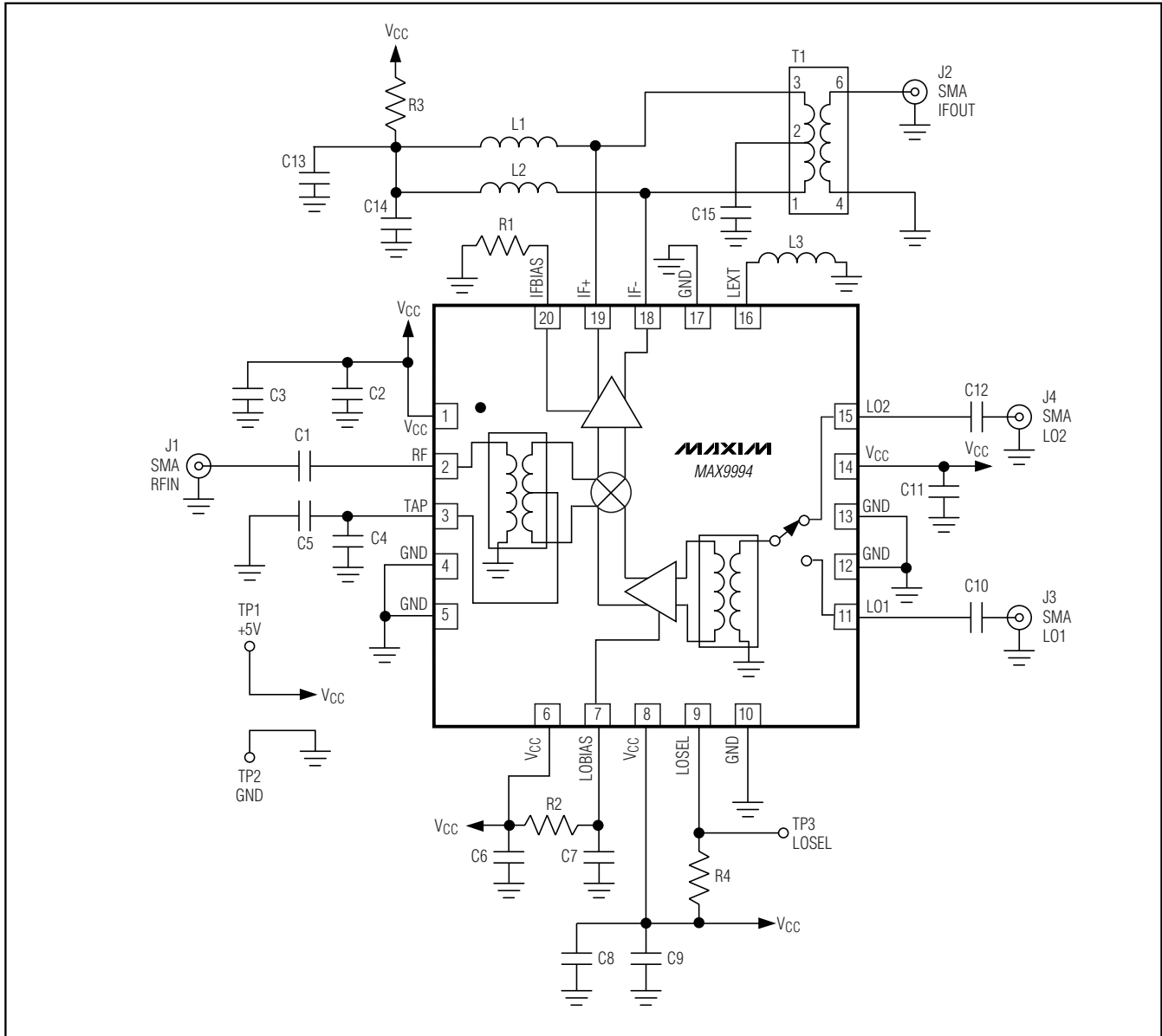

Figure 2. MAX9994 EV Kit Schematic

MAX9994 Evaluation Kit

Evaluates: MAX9994

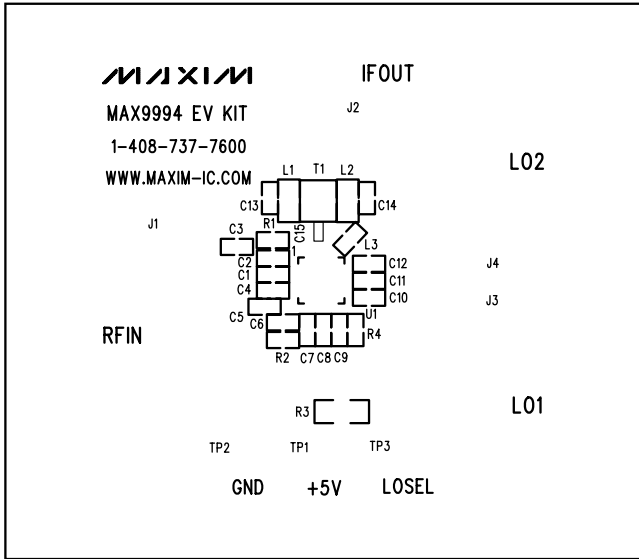

Figure 3. MAX9994 EV Kit PC Board Layout—Top Silkscreen

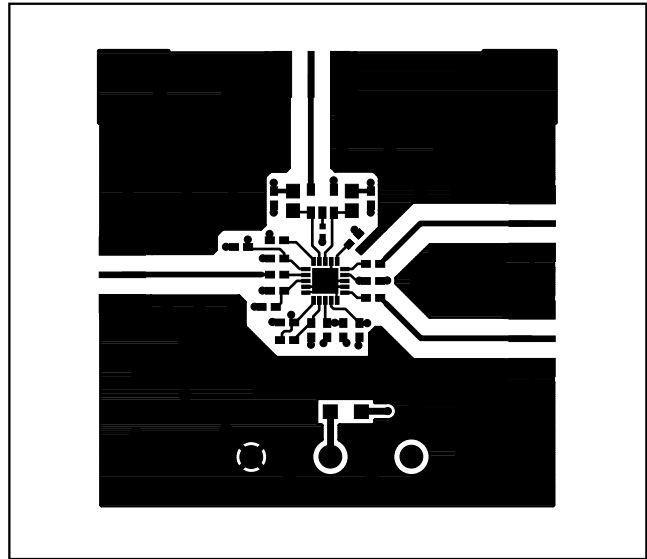

Figure 5. MAX9994 EV Kit PC Board Layout—Top Layer Metal

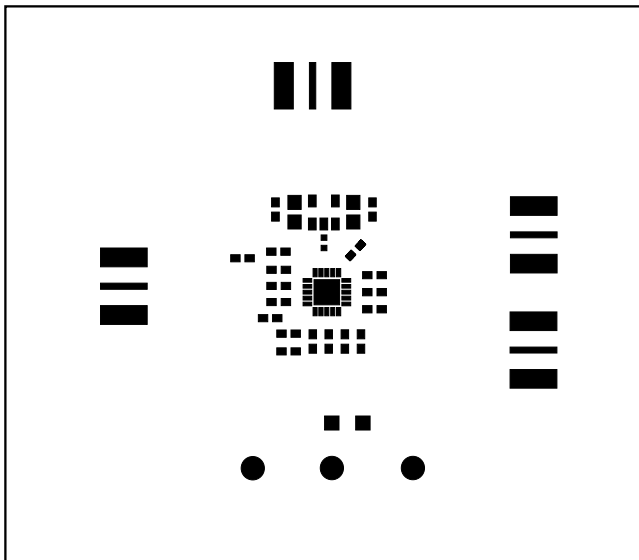

Figure 4. MAX9994 EV Kit PC Board Layout—Top Soldermask

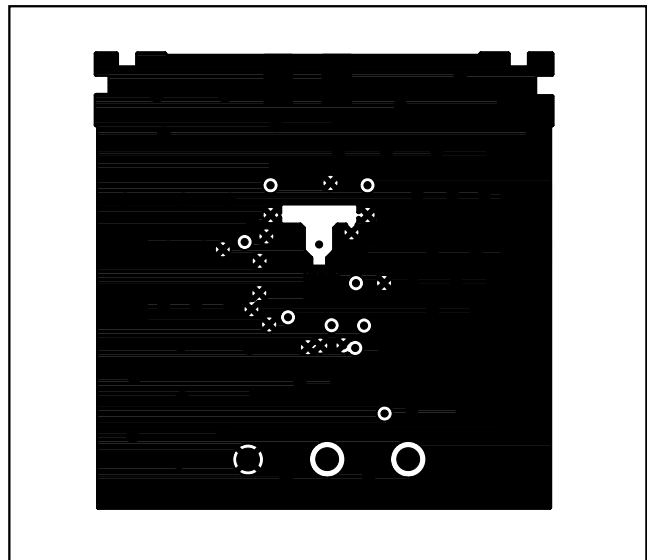

Figure 6. MAX9994 EV Kit PC Board Layout—Inner Layer 2 (GND)

MAX9994 Evaluation Kit

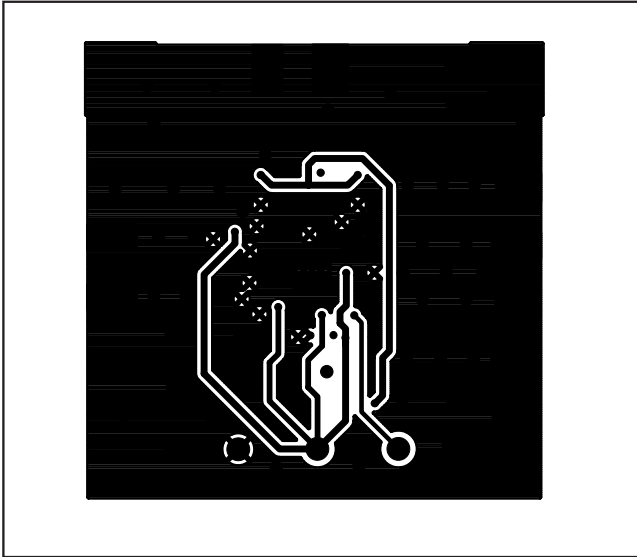

Figure 7. MAX9994 EV Kit PC Board Layout—Inner Layer 3 (Routes)

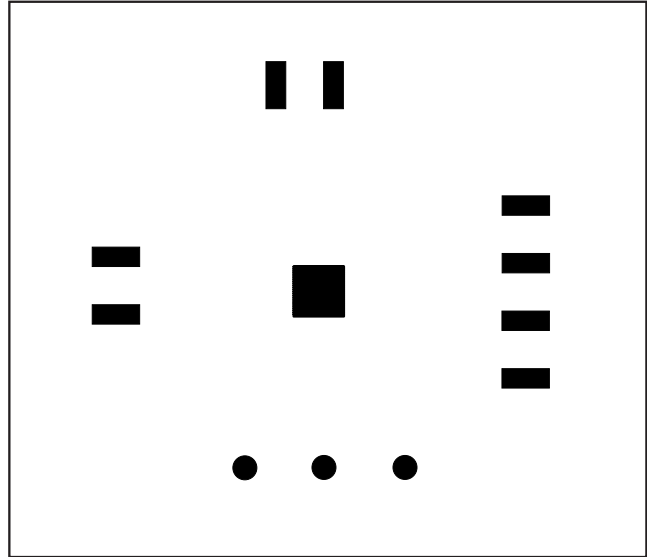

Figure 9. MAX9994 EV Kit PC Board Layout—Bottom Soldermask

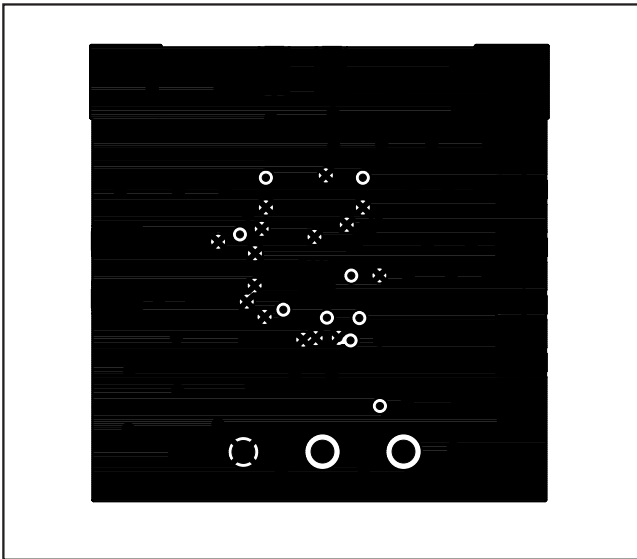

Figure 8. MAX9994 EV Kit PC Board Layout—Bottom Layer (Metal)

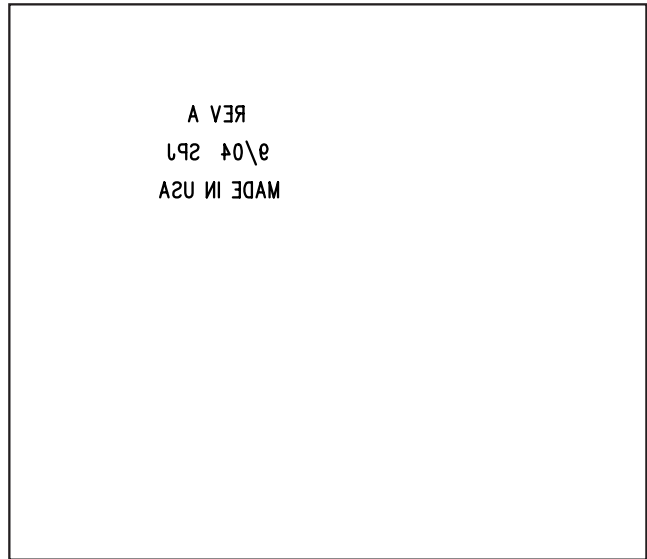

Figure 10. MAX9994 EV Kit PC Board Layout—Bottom Silkscreen

Maxim cannot assume responsibility for use of any circuitry other than circuitry entirely embodied in a Maxim product. No circuit patent licenses are implied. Maxim reserves the right to change the circuitry and specifications without notice at any time.

8 **Maxim Integrated Products, 120 San Gabriel Drive, Sunnyvale, CA 94086 408-737-7600**



Компания «ЭлектроПласт» предлагает заключение долгосрочных отношений при поставках импортных электронных компонентов на взаимовыгодных условиях!

Наши преимущества:

- Оперативные поставки широкого спектра электронных компонентов отечественного и импортного производства напрямую от производителей и с крупнейших мировых складов;
- Поставка более 17-ти миллионов наименований электронных компонентов;
- Поставка сложных, дефицитных, либо снятых с производства позиций;
- Оперативные сроки поставки под заказ (от 5 рабочих дней);
- Экспресс доставка в любую точку России;
- Техническая поддержка проекта, помощь в подборе аналогов, поставка прототипов;
- Система менеджмента качества сертифицирована по Международному стандарту ISO 9001;
- Лицензия ФСБ на осуществление работ с использованием сведений, составляющих государственную тайну;
- Поставка специализированных компонентов (Xilinx, Altera, Analog Devices, Intersil, Interpoint, Microsemi, Aeroflex, Peregrine, Syfer, Eurofarad, Texas Instrument, Miteq, Cobham, E2V, MA-COM, Hittite, Mini-Circuits, General Dynamics и др.);

Помимо этого, одним из направлений компании «ЭлектроПласт» является направление «Источники питания». Мы предлагаем Вам помощь Конструкторского отдела:

- Подбор оптимального решения, техническое обоснование при выборе компонента;
- Подбор аналогов;
- Консультации по применению компонента;
- Поставка образцов и прототипов;
- Техническая поддержка проекта;
- Защита от снятия компонента с производства.



Как с нами связаться

Телефон: 8 (812) 309 58 32 (многоканальный)

Факс: 8 (812) 320-02-42

Электронная почта: org@eplast1.ru

Адрес: 198099, г. Санкт-Петербург, ул. Калинина, дом 2, корпус 4, литера А.