



LUXEON CX Plus CoB

Lowest thermal resistance with industry standard footprint

LUXEON CX Plus CoB has six products covering lumen packages between 500 and 7,000 lumens in a standard footprint. Due to its industry leading thermal resistance and robust substrate material, LUXEON CX Plus CoB enables cooler, more efficient fixtures. LUXEON CX Plus CoB benefits from an existing ecosystem for fast and immediate design-in while retaining existing optics, clamps and documentation.



FEATURES AND BENEFITS

Lowest thermal resistance, allowing more reliable systems and higher lm/W

An immediate, effortless upgrade to existing designs currently using legacy CoBs with a square footprint

MCPCB substrate that enables more robust systems versus ceramic

3-step MacAdam ellipse color definition for 80CRI and *Freedom from Binning*

Available in 80CRI and 90CRI

PRIMARY APPLICATIONS

Downlights

Spotlights

Table of Contents

General Product Information	2
Product Test Conditions	2
Part Number Nomenclature	2
Lumen Maintenance	2
Environmental Compliance	2
Performance Characteristics	3
Product Selection Guide	3
Optical Characteristics	4
Electrical and Thermal Characteristics	5
Absolute Maximum Ratings	5
Characteristic Curves	6
Spectral Power Distribution Characteristics	6
Light Output Characteristics	6
Forward Current Characteristics	8
Radiation Pattern Characteristics	9
Color Bin Definitions	10
Mechanical Dimensions	11
Packaging and Labeling Information	12
Tube	12
Inner Box	13
Outer Box	14

General Product Information

Product Test Conditions

LUXEON CX Plus CoB LEDs are tested and binned with a DC drive current specified below at a junction temperature, T_j , of 85°C:

100mA	-	LUXEON CoB S01
200mA	-	LUXEON CoB M02
350mA	-	LUXEON CoB M03
450mA	-	LUXEON CoB L04
550mA	-	LUXEON CoB L05
800mA	-	LUXEON CoB L08

Part Number Nomenclature

Part numbers for LUXEON CX Plus CoB follow the convention below:

L 2 C 4 - **A A B B** - **D D D E F F G 0**

Where:

- A A** - designates nominal CCT (27=2700K, 30=3000K, 35=3500K, 40=4000K, 50=5000K)
- B B** - designates minimum CRI (80=80CRI and 90=90CRI)
- D D D** - designates product configuration (S01, M02, M03, L04, L05, L08)
- F F** - designates light emitting surface (LES) size (06=6mm, 09=9mm, 12=12mm, 14=14mm)
- G** - designates options for product specification

Therefore, the following part number is used for a LUXEON CX Plus CoB M03, 3000K 80CRI, with a 9mm LES:

L 2 C 4 - **3 0 8 0** - **M 0 3 E 0 9 0 0**

Lumen Maintenance

Please contact your local Sales Representative or Lumileds Technical Solutions Manager for more information about the long-term performance of this product.

Environmental Compliance

Lumileds LLC is committed to providing environmentally friendly products to the solid-state lighting market. LUXEON CX Plus CoB is compliant to the European Union directives on the restriction of hazardous substances in electronic equipment, namely the RoHS Directive 2011/65/EU and REACH Regulation (EC) 1907/2006. Lumileds LLC will not intentionally add the following restricted materials to its products: lead, mercury, cadmium, hexavalent chromium, polybrominated biphenyls (PBB) or polybrominated diphenyl ethers (PBDE).

Performance Characteristics

Product Selection Guide

Table 1. Product performance of LUXEON CX Plus CoB at specified test current, T_j=85°C.

PRODUCT	NOMINAL CCT	MINIMUM CRI ^[1, 2, 3]	LUMINOUS FLUX ^[1, 4] (lm)		TYPICAL LUMINOUS EFFICACY (lm/W)	TEST CURRENT (mA)	LES ^[5] (mm)	PART NUMBER
			MINIMUM	TYPICAL				
LUXEON CoB S01	2700K	80	376	418	121	100	6	L2C4-2780-S01E0600
	3000K	80	396	440	128	100	6	L2C4-3080-S01E0600
	3500K	80	404	449	130	100	6	L2C4-3580-S01E0600
	4000K	80	412	458	133	100	6	L2C4-4080-S01E0600
	5000K	80	412	458	133	100	6	L2C4-5080-S01E0600
	2700K	90	320	356	103	100	6	L2C4-2790-S01E0600
	3000K	90	337	374	103	100	6	L2C4-3090-S01E0600
	3500K	90	356	396	115	100	6	L2C4-3590-S01E0600
	4000K	90	356	396	115	100	6	L2C4-4090-S01E0600
LUXEON CoB M02	2700K	80	770	855	124	200	9	L2C4-2780-M02E0900
	3000K	80	810	900	130	200	9	L2C4-3080-M02E0900
	3500K	80	826	918	133	200	9	L2C4-3580-M02E0900
	4000K	80	842	936	136	200	9	L2C4-4080-M02E0900
	5000K	80	842	936	136	200	9	L2C4-5080-M02E0900
	2700K	90	656	729	106	200	9	L2C4-2790-M02E0900
	3000K	90	689	765	111	200	9	L2C4-3090-M02E0900
	3500K	90	729	810	117	200	9	L2C4-3590-M02E0900
	4000K	90	729	810	117	200	9	L2C4-4090-M02E0900
LUXEON CoB M03	2700K	80	1317	1463	120	350	9	L2C4-2780-M03E0900
	3000K	80	1386	1540	126	350	9	L2C4-3080-M03E0900
	3500K	80	1414	1571	129	350	9	L2C4-3580-M03E0900
	4000K	80	1442	1602	132	350	9	L2C4-4080-M03E0900
	5000K	80	1442	1602	132	350	9	L2C4-5080-M03E0900
	2700K	90	1122	1247	102	350	9	L2C4-2790-M03E0900
	3000K	90	1178	1309	107	350	9	L2C4-3090-M03E0900
	3500K	90	1247	1386	114	350	9	L2C4-3590-M03E0900
	4000K	90	1247	1386	114	350	9	L2C4-4090-M03E0900
LUXEON CoB L04	3000K	80	1845	2050	130	450	12	L2C4-3080-L04E1200
	3500K	80	1882	2091	133	450	12	L2C4-3580-L04E1200
	4000K	80	1919	2132	135	450	12	L2C4-4080-L04E1200
	5000K	80	1919	2132	135	450	12	L2C4-5080-L04E1200
	3000K	90	1569	1743	111	450	12	L2C4-3090-L04E1200
	3500K	90	1661	1845	117	450	12	L2C4-3590-L04E1200
	4000K	90	1661	1845	117	450	12	L2C4-4090-L04E1200

Table 1 continued on next page:

1. Lumileds maintains a tolerance of ±2 on CRI and ±6.5% on luminous flux measurements.
2. Typical CRI is approximately 2 points higher than the minimum CRI specified, but this is not guaranteed.
3. R9 value of 90CRI products is >50.
4. Maximum luminous flux is 10% above typical luminous flux.
5. Light Emitting Surface (LES) is the inner diameter (phosphor area) inside the dam.

Table 1. Product performance of LUXEON CX Plus CoB at specified test current, $T_j=85^\circ\text{C}$ continued.

PRODUCT	NOMINAL CCT	MINIMUM CRI ^[1, 2, 3]	LUMINOUS FLUX ^[1, 4] (lm)		TYPICAL LUMINOUS EFFICACY (lm/W)	TEST CURRENT (mA)	LES ^[5] (mm)	PART NUMBER
			MINIMUM	TYPICAL				
LUXEON CoB L05	3000K	80	2268	2520	132	550	12	L2C4-3080-L05E1200
	3500K	80	2313	2570	134	550	12	L2C4-3580-L05E1200
	4000K	80	2359	2621	137	550	12	L2C4-4080-L05E1200
	5000K	80	2359	2621	137	550	12	L2C4-5080-L05E1200
	3000K	90	1928	2142	112	550	12	L2C4-3090-L05E1200
	3500K	90	2041	2268	118	550	12	L2C4-3590-L05E1200
	4000K	90	2041	2268	118	550	12	L2C4-4090-L05E1200
LUXEON CoB L08	2700K	80	3207	3563	128	800	14	L2C4-2780-L08E1400
	3000K	80	3375	3750	135	800	14	L2C4-3080-L08E1400
	3500K	80	3443	3825	137	800	14	L2C4-3580-L08E1400
	4000K	80	3510	3900	140	800	14	L2C4-4080-L08E1400
	5000K	80	3510	3900	140	800	14	L2C4-5080-L08E1400
	2700K	90	2734	3038	109	800	14	L2C4-2790-L08E1400
	3000K	90	2869	3188	115	800	14	L2C4-3090-L08E1400
	3500K	90	3038	3375	121	800	14	L2C4-3590-L08E1400
	4000K	90	3038	3375	121	800	14	L2C4-4090-L08E1400

Notes for Table 1:

1. Lumileds maintains a tolerance of ± 2 on CRI and $\pm 6.5\%$ on luminous flux measurements.
2. Typical CRI is approximately 2 points higher than the minimum CRI specified, but this is not guaranteed.
3. R9 value of 90CRI products is >50 .
4. Maximum luminous flux is 10% above typical luminous flux.
5. Light Emitting Surface (LES) is the inner diameter (phosphor area) inside the dam.

Optical Characteristics

Table 2. Optical characteristics for LUXEON CX Plus CoB at specified test current, $T_j=85^\circ\text{C}$.

PART NUMBER	TYPICAL TOTAL INCLUDED ANGLE ^[1]	TYPICAL VIEWING ANGLE ^[2]
L2C4-xxxx-xxxExx00	135°	115°

Notes for Table 2:

1. Total angle at which 90% of total luminous flux is captured.
2. Viewing angle is the off axis angle from the LED centerline where the luminous intensity is $\frac{1}{2}$ of the peak value.

Electrical and Thermal Characteristics

Table 3. Electrical and thermal characteristics for LUXEON CX Plus CoB at specified test current, $T_j=85^\circ\text{C}$.

PART NUMBER	FORWARD VOLTAGE ^[1] (V_f)			TYPICAL TEMPERATURE COEFFICIENT OF FORWARD VOLTAGE ^[2] (mV/ $^\circ\text{C}$)	TYPICAL THERMAL RESISTANCE—JUNCTION TO CASE ^[3] ($^\circ\text{C}/\text{W}$)
	MINIMUM	TYPICAL	MAXIMUM		
L2C4-xxxx-S01E0600	32.5	34.5	37.5	-16	1.70
L2C4-xxxx-M02E0900	32.5	34.5	37.5	-16	0.90
L2C4-xxxx-M03E0900	32.5	35.0	37.5	-16	0.60
L2C4-xxxx-L04E1200	32.5	34.8	37.5	-16	0.50
L2C4-xxxx-L05E1200	32.5	34.8	37.5	-16	0.45
L2C4-xxxx-L08E1400	32.5	34.5	37.5	-16	0.38

Notes for Table 3:

1. Lumileds maintains a tolerance of $\pm 2\%$ on forward voltage measurements.
2. Measured between 25°C and 85°C .
3. Thermal resistance is measured between junction and the bottom of the LUXEON CoB substrate.

Absolute Maximum Ratings

Table 4. Absolute maximum ratings for LUXEON CX Plus CoB.

PARAMETER	MAXIMUM PERFORMANCE
DC Forward Current ^[1,2]	2x test current, except for S01, rated at 250mA maximum
LED Junction Temperature ^[1] (DC & Pulse)	125°C
ESD Sensitivity (ANSI/ESDA/JEDEC JS-001-2012)	Class 3B
Operating Case Temperature ^[1]	-40°C to 105°C
LED Storage Temperature	-40°C to 120°C
Allowable Reflow Cycles	3
Reverse Voltage (V_{reverse})	LUXEON LEDs are not designed to be driven in reverse bias

Notes for Table 4:

1. Proper current derating must be observed to maintain the junction temperature below the maximum allowable junction temperature.
2. Residual periodic variations due to power conversion from alternating current (AC) to direct current (DC), also called "ripple," are acceptable if the following conditions are met:
 - The frequency of the ripple current is 100Hz or higher
 - The average current for each cycle does not exceed the maximum allowable DC forward current
 - The maximum amplitude of the ripple does not exceed the maximum peak pulsed forward current

Characteristic Curves

Spectral Power Distribution Characteristics

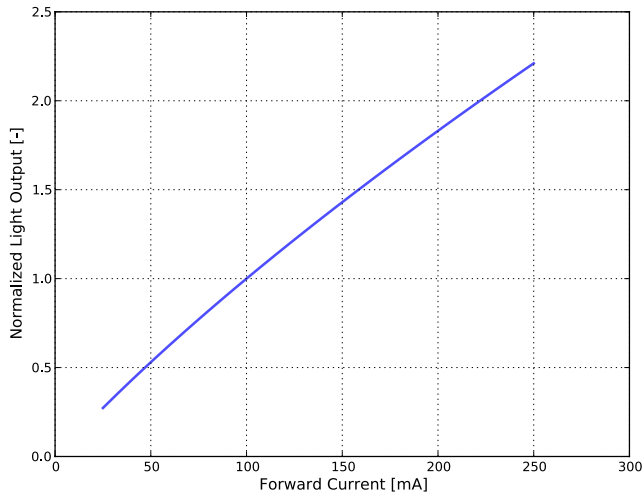

Figure 1. Typical normalized power vs. wavelength for L2C4-xxxx-xxxExx00 at specified test current, $T_j=85^{\circ}\text{C}$.

Light Output Characteristics



Figure 2. Typical normalized light output vs. junction temperature for L2C4-xxxx-xxxExx00 at specified test current.



L2C4-xxxx-S01E0600

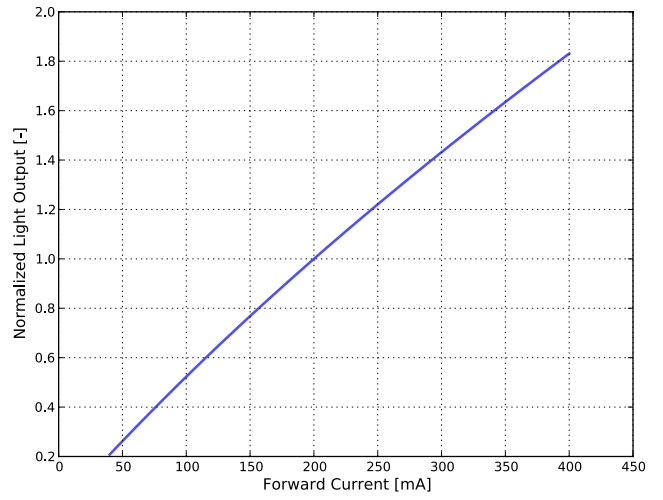

L2C4-xxxx-M02E0900

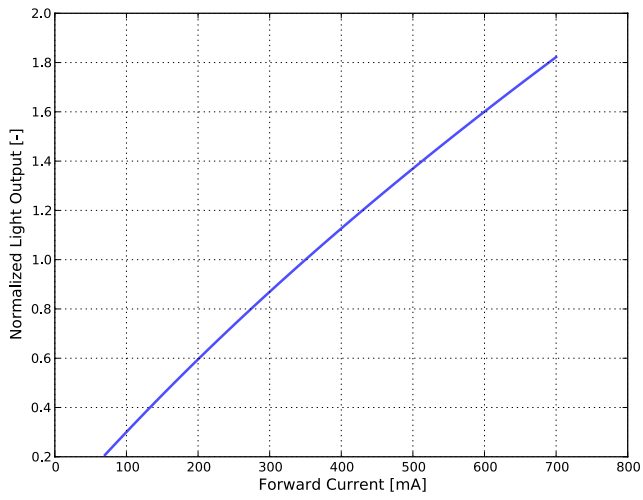

L2C4-xxxx-M03E0900

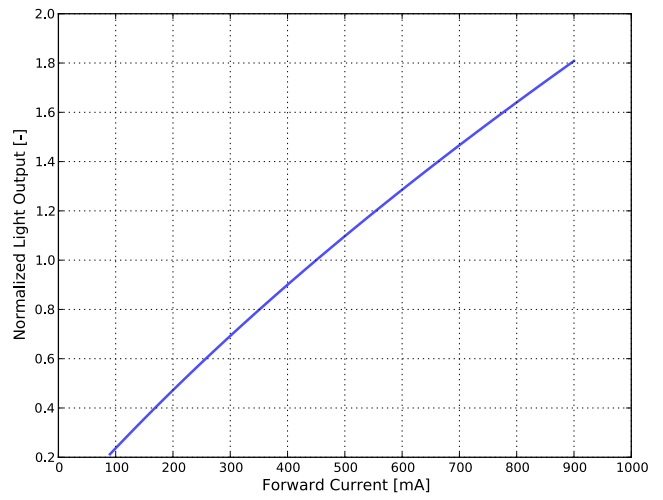

L2C4-xxxx-L04E1200

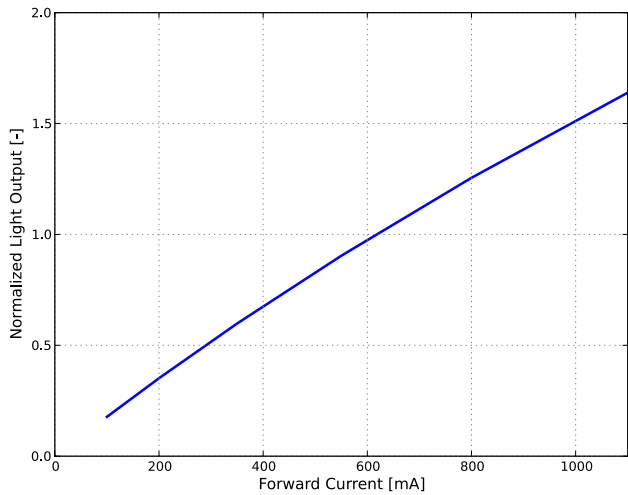

L2C4-xxxx-L05E1200

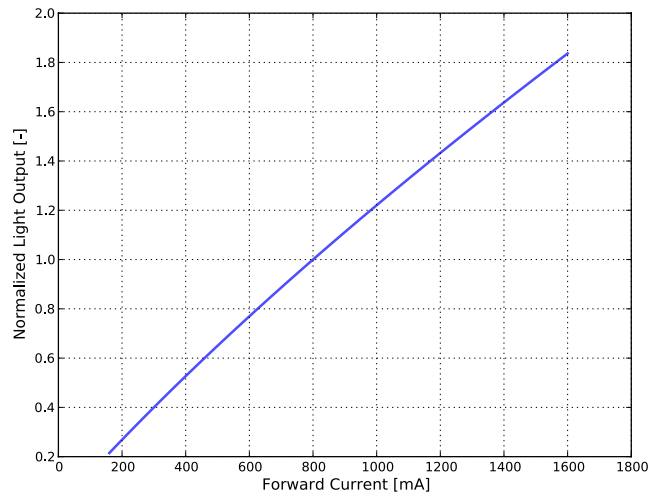

L2C4-xxxx-L08E1400

Figure 3. Typical normalized light output vs. forward current for LUXEON CX Plus CoB at $T_j=85^\circ\text{C}$.

Forward Current Characteristics



L2C4-xxxx-S01E0600



L2C4-xxxx-M02E0900



L2C4-xxxx-M03E0900

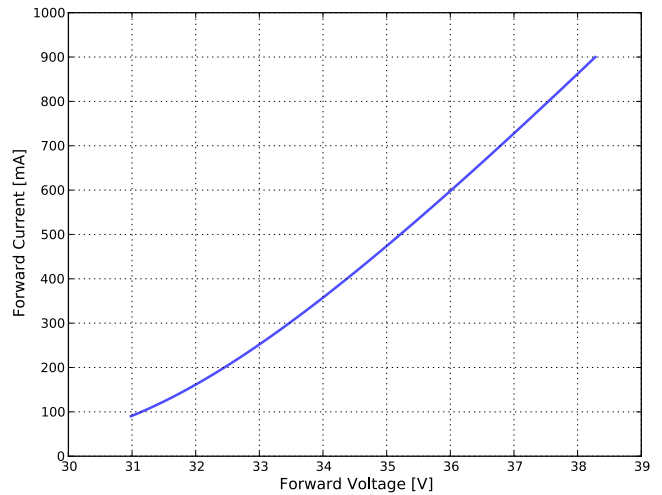

L2C4-xxxx-L04E1200



L2C4-xxxx-L05E1200

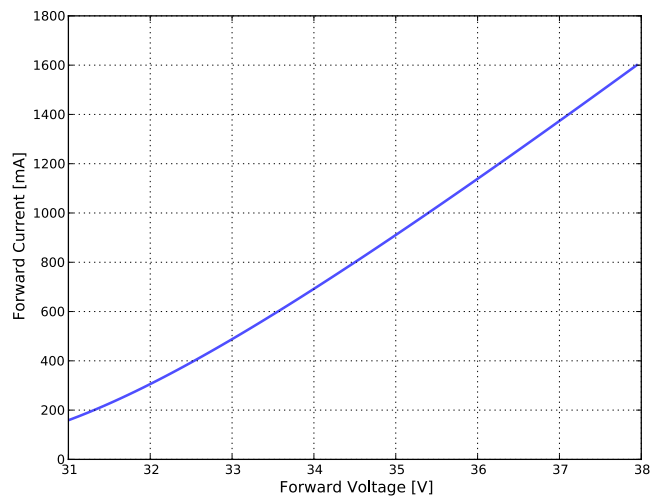

L2C4-xxxx-L08E1400

Figure 4. Typical forward current vs. forward voltage for LUXEON CX Plus CoB at $T_j=85^\circ\text{C}$.

Radiation Pattern Characteristics

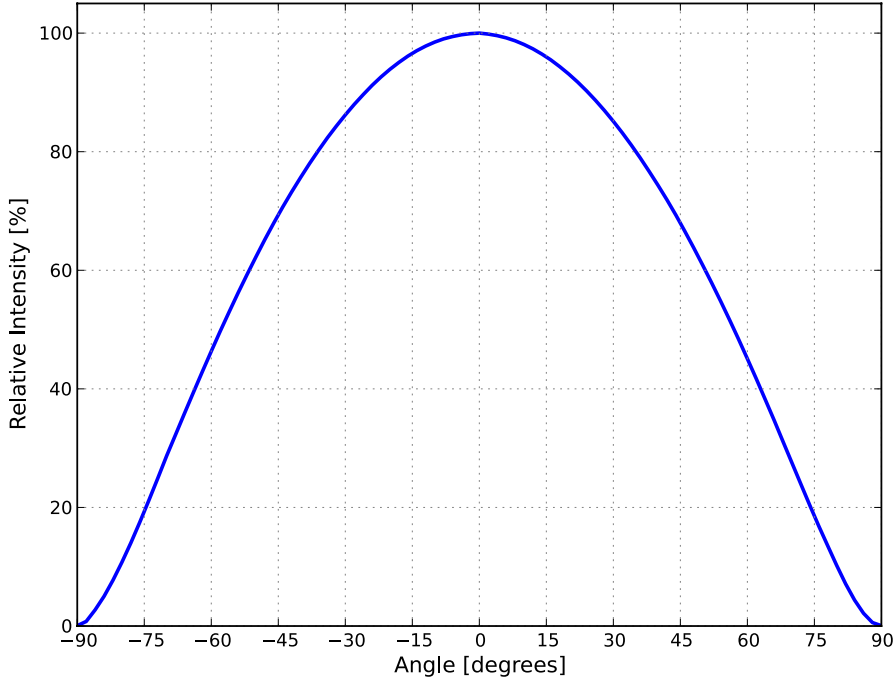

Figure 5. Typical radiation pattern for LUXEON CX Plus CoB at specified test current, $T_j=85^{\circ}\text{C}$.

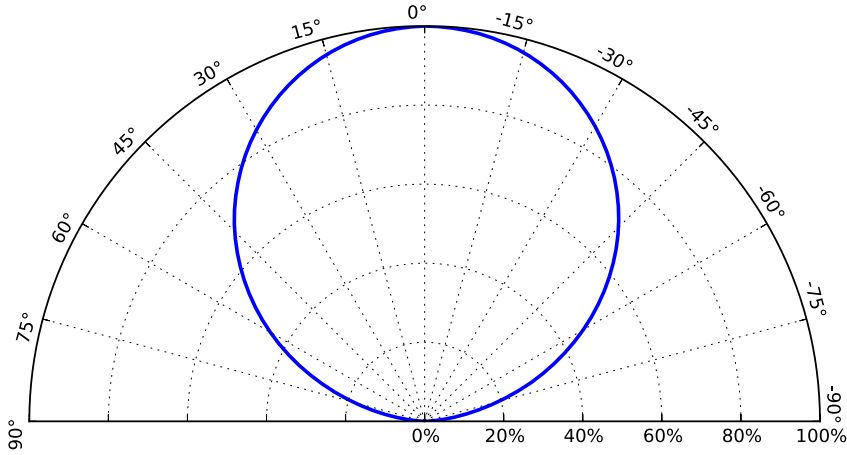

Figure 6. Typical polar radiation pattern for LUXEON CX Plus CoB at specified test current, $T_j=85^{\circ}\text{C}$.

Color Bin Definitions

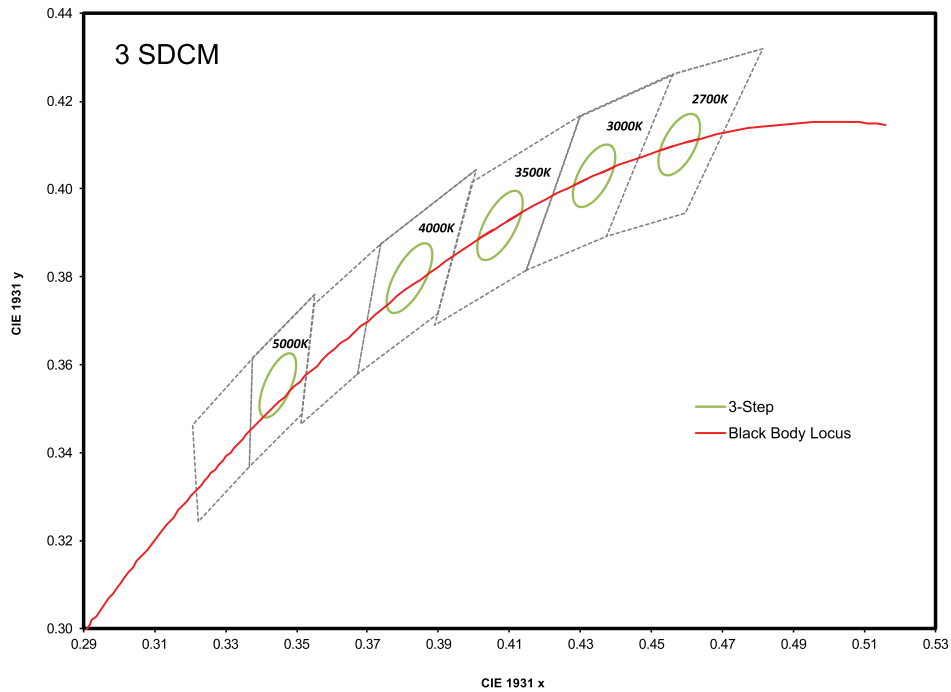

Figure 7. 3-step MacAdam ellipse illustration for Table 5.

Table 5. 3-step MacAdam ellipse color bin definition for LUXEON CX Plus CoB.

NOMINAL CCT	COLOR SPACE	CENTER POINT ^[1] (cx, cy)	MAJOR AXIS, a	MINOR AXIS, b	ELLIPSE ROTATION ANGLE, θ
2700K	Single 3-step MacAdam ellipse	(0.4578, 0.4101)	0.00810	0.00420	53.70°
3000K	Single 3-step MacAdam ellipse	(0.4338, 0.4030)	0.00834	0.00408	53.20°
3500K	Single 3-step MacAdam ellipse	(0.4073, 0.3917)	0.00927	0.00414	54.00°
4000K	Single 3-step MacAdam ellipse	(0.3818, 0.3797)	0.00939	0.00402	53.70°
5000K	Single 3-step MacAdam ellipse	(0.3447, 0.3553)	0.00822	0.00354	59.60°

Notes for Table 5:

1. Lumileds maintains a tolerance of ± 0.005 on x and y coordinates in the CIE 1931 color space.

Packaging and Labeling Information

LUXEON CX Plus CoB LEDs are packaged in tubes then in a carton box. Each tube contains a specified number of LEDs. The LEDs in each tube come from a single category code, ensuring they are all well-matched for light output, color, and forward voltage. Each tube contains a rubber stopper at one end. The tube label has both alphanumeric and bar code information. The carton boxes have printed information providing part numbers with CAT codes that indicate luminous flux, color and forward voltage bins.

Table 6. Number of LEDs per tube for LUXEON CX Plus CoB.

PART NUMBER	TOTAL UNITS PER TUBE	TOTAL TUBES PER INNER BOX	TOTAL UNITS PER INNER BOX
L2C4-xxxxS01E0600	20	5	100
L2C4-xxxxM02E0900	20	5	100
L2C4-xxxxM03E0900	20	5 </td <td>100</td>	100
L2C4-xxxxL04E1200	20	5	100
L2C4-xxxxL05E1200	20	5	100
L2C4-xxxxL08E1400	20	5	100

Tube

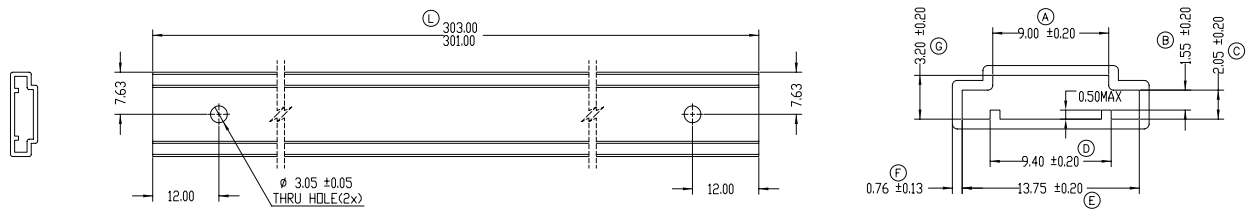

Figure 9a. Tube dimensions for L2C4-xxxx-S01E0600.

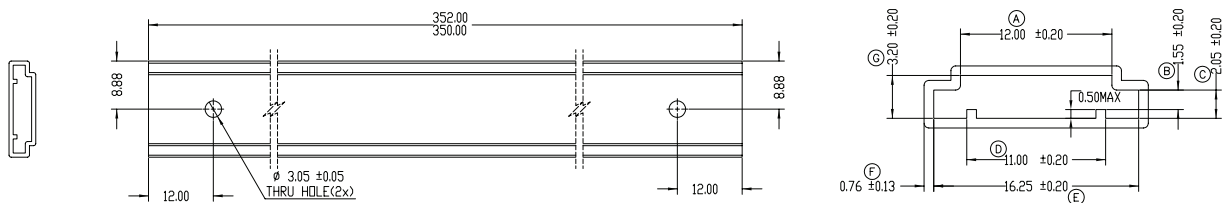

Figure 9b. Tube dimensions for L2C4-xxxx-M02E0900 and L2C4-xxxx-M03E0900.



Figure 9c. Tube dimensions for L2C4-xxxx-L04E1200, L2C4-xxxx-L05E1200 and L2C4-xxxx-L08E1400.

- Notes for Figures 9a, 9b and 9c:
1. Drawings are not to scale.
 2. All dimensions are in millimeters.

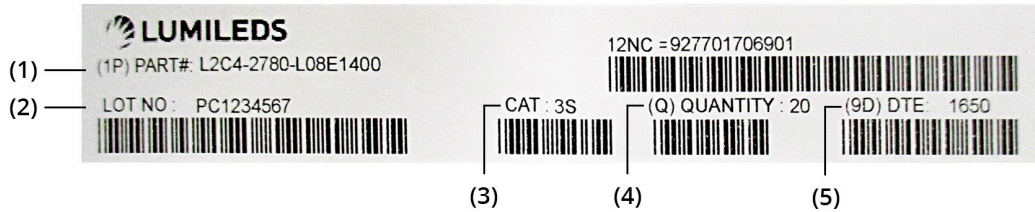

Figure 10. Example of a tube label for LUXEON CX Plus CoB.

Notes for Figure 10 – Tube Label descriptions for customer use:

Field labels not described are for Lumileds internal use only.

1. Philips part number.
2. Unique production lot identification number. This number is required for traceability purpose.
3. Product category code.
4. Number of LED emitters in a tube.
5. LED test date in YYWW format.

Inner Box

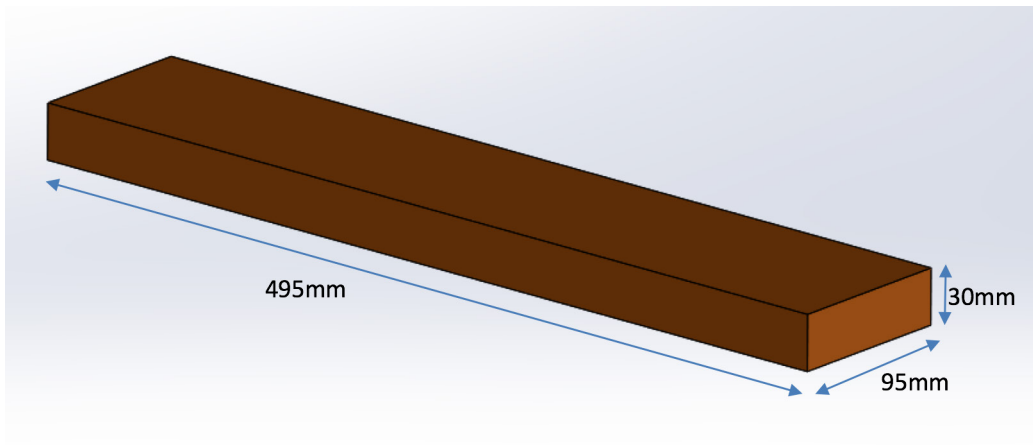

Figure 11. Dimensions for inner box packaging for LUXEON CX Plus CoB.

Table 7. Inner box information for LUXEON CX Plus CoB.

BOX TYPE	DIMENSIONS (mm)			AVERAGE WEIGHT (100pcs/box)
	H	L	W	
Inner Box	30	495	95	0.232Kg



Figure 12. Example of inner box label for LUXEON CX Plus CoB.

Notes for Figure 12 – Inner Box Label descriptions for customer use:

Field labels not described are for Lumileds internal use only.

1. Lumileds part number.
2. Number of LED emitters in a box.
3. LED test date in YYWW format.
4. Customer part number for custom requests only.
5. Unique production lot identification number. This number is required for traceability purpose.
6. Product category code.

Outer Box

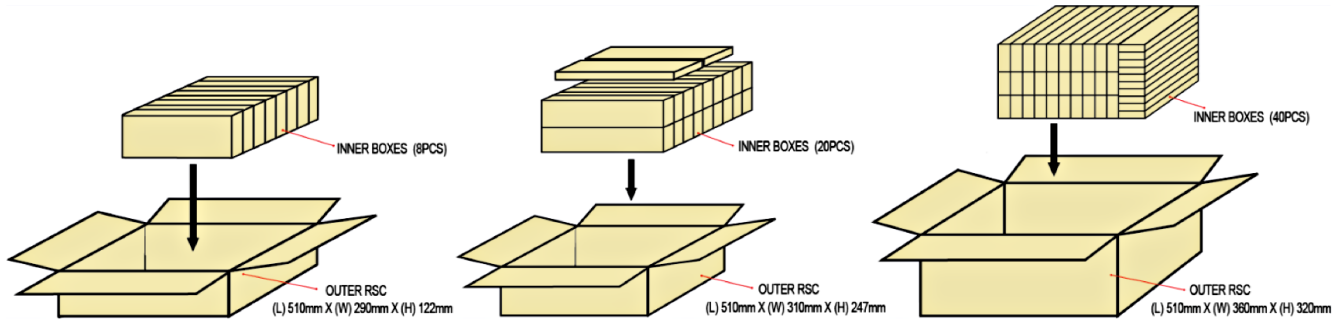

Figure 13. Dimensions for outer box packaging for LUXEON CX Plus CoB.

Table 8. Outer box information for LUXEON CX Plus CoB.

BOX TYPE	DIMENSIONS (mm)			MAXIMUM INNER BOXES PER OUTER BOX	MAXIMUM QUANTITY PER OUTER BOX	AVERAGE WEIGHT (100pcs/box)
	H	L	W			
Outer Box 8	122	510	290	8	800	2.36Kg
Outer Box 20	247	510	310	20	2000	5.34Kg
Outer Box 40	320	510	360	40	4000	10.88Kg

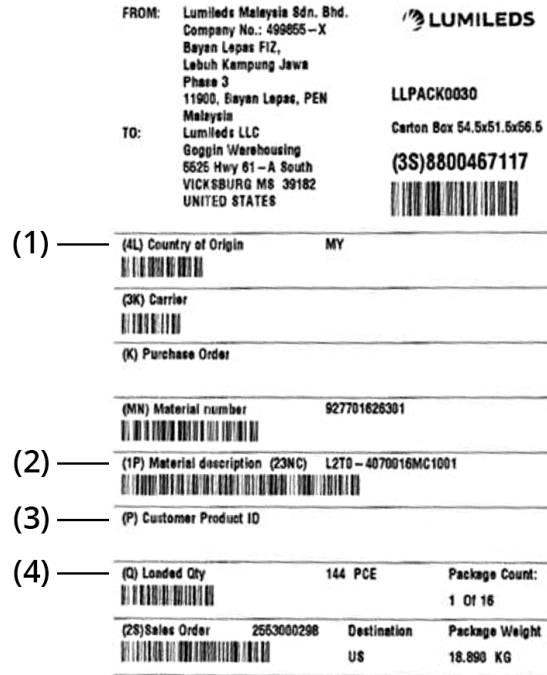

Figure 14. Example of outer box label for LUXEON CX Plus CoB.

Notes for Figure 14 – Outer Box Label descriptions for customer use:

Field labels not described are for Lumileds internal use only.

1. Country code of origin of manufacturing of parts (e.g. MY for Malaysia, CN for China) according to ISO 3166-1 alpha-2 document.
2. Lumileds part number.
3. Customer part number for custom requests only.
4. Total number of LED emitters in a shipment box.

About Lumileds

Lumileds is the global leader in light engine technology. The company develops, manufactures and distributes groundbreaking LEDs and automotive lighting products that shatter the status quo and help customers gain and maintain a competitive edge.

With a rich history of industry “firsts,” Lumileds is uniquely positioned to deliver lighting advancements well into the future by maintaining an unwavering focus on quality, innovation and reliability.

To learn more about our portfolio of light engines, visit lumileds.com.



©2017 Lumileds Holding B.V. All rights reserved.
LUXEON is a registered trademark of the Lumileds Holding B.V.
in the United States and other countries.

lumileds.com

Neither Lumileds Holding B.V. nor its affiliates shall be liable for any kind of loss of data or any other damages, direct, indirect or consequential, resulting from the use of the provided information and data. Although Lumileds Holding B.V. and/or its affiliates have attempted to provide the most accurate information and data, the materials and services information and data are provided “as is,” and neither Lumileds Holding B.V. nor its affiliates warrants or guarantees the contents and correctness of the provided information and data. Lumileds Holding B.V. and its affiliates reserve the right to make changes without notice. You as user agree to this disclaimer and user agreement with the download or use of the provided materials, information and data.



Компания «ЭлектроПласт» предлагает заключение долгосрочных отношений при поставках импортных электронных компонентов на взаимовыгодных условиях!

Наши преимущества:

- Оперативные поставки широкого спектра электронных компонентов отечественного и импортного производства напрямую от производителей и с крупнейших мировых складов;
- Поставка более 17-ти миллионов наименований электронных компонентов;
- Поставка сложных, дефицитных, либо снятых с производства позиций;
- Оперативные сроки поставки под заказ (от 5 рабочих дней);
- Экспресс доставка в любую точку России;
- Техническая поддержка проекта, помощь в подборе аналогов, поставка прототипов;
- Система менеджмента качества сертифицирована по Международному стандарту ISO 9001;
- Лицензия ФСБ на осуществление работ с использованием сведений, составляющих государственную тайну;
- Поставка специализированных компонентов (Xilinx, Altera, Analog Devices, Intersil, Interpoint, Microsemi, Aeroflex, Peregrine, Syfer, Eurofarad, Texas Instrument, Miteq, Cobham, E2V, MA-COM, Hittite, Mini-Circuits, General Dynamics и др.);

Помимо этого, одним из направлений компании «ЭлектроПласт» является направление «Источники питания». Мы предлагаем Вам помощь Конструкторского отдела:

- Подбор оптимального решения, техническое обоснование при выборе компонента;
- Подбор аналогов;
- Консультации по применению компонента;
- Поставка образцов и прототипов;
- Техническая поддержка проекта;
- Защита от снятия компонента с производства.



Как с нами связаться

Телефон: 8 (812) 309 58 32 (многоканальный)

Факс: 8 (812) 320-02-42

Электронная почта: org@eplast1.ru

Адрес: 198099, г. Санкт-Петербург, ул. Калинина, дом 2, корпус 4, литера А.