

System Lens Driver Series for Mobile Phone Cameras

# Parallel Interface Type Lens Drivers for Voice Coil Motor



BD6883GUL, BH6453GUL, BD6886GUL, BD6369GUL

No.12015EAT02

## ●Description

The BD6883GUL, and the BH6453GUL motor driver provide 1 Constant-Current Driver Half-bridge, and 1 Constant-Voltage Driver Half-bridge channel. The BD6886GUL, and the BD6369GUL motor driver provide 1 Constant-Voltage Driver H-bridge channel. These lens drivers are offered in an ultra-small functional lens system for use in an auto focus system using a Voice Coil motor.

## ●Features

### 1) BD6883GUL Characteristics

- 1) Ultra-small chip size package; 1.1mm × 1.6mm × 0.55mm
- 2) Low ON-Resistance Power CMOS output; on high side PMOS typ.0.65Ω, on low side NMOS typ.0.40Ω
- 3) ESD resistance (Human Body Model); 8kV
- 4) Built-in ±5% high-precision Constant-Voltage Driver (phase compensation capacitor-free design)
- 5) Built-in UVLO (Under Voltage Locked Out: UVLO)
- 6) Built-in TSD (Thermal Shut Down) circuit
- 7) Standby current consumption: 0μA Typ.

### 2) BH6453GUL Characteristics

- 1) Ultra-small chip size package; 1.5mm × 0.9mm × 0.55mm
- 2) Low ON-Resistance Power CMOS output; on high side PMOS typ.1.2Ω, on low side NMOS typ.0.4Ω
- 3) ESD resistance (Human Body Model); 8kV
- 4) Built in resistor for output current detect (phase compensation capacitor-free design)
- 5) 1.8V can be put into each control input terminal
- 6) Built-in UVLO (Under Voltage Locked Out: UVLO)
- 7) Built-in TSD (Thermal Shut Down) circuit
- 8) Standby current consumption: 0μA Typ.

### 3) BD6886GUL, BD6369GUL Characteristics

- 1) Ultra-small chip size package; 2.1mm × 2.1mm × 0.55mm
- 2) Low ON-Resistance Power CMOS output; on high and low sides in total typ.0.80Ω
- 3) ESD resistance (Human Body Model); 8kV
- 4) Built-in ±5% high-precision Constant-Voltage Driver (phase compensation capacitor-free design)
- 5) Control Input mode selection function
- 6) Built-in UVLO (Under Voltage Locked Out: UVLO)
- 7) Built-in TSD (Thermal Shut Down) circuit
- 8) Standby current consumption: 0μA Typ.

● Absolute Maximum Ratings (Ta=+25°C)

Parameter	Symbol	Limit				Unit
		BD6883GUL	BH6453GUL	BD6886GUL	BD6369GUL	
Power supply voltage	VCC	-0.5 to +6.5	-0.5 to +4.5	-0.5 to +6.5	-0.5 to +6.5	V
Motor power supply voltage	VM	-	-	-0.5 to +6.5	-0.5 to +6.5	V
Control input voltage	VIN	-0.5 to VCC+0.5	-0.5 to VCC+0.5	-0.5 to VCC+0.5	-0.5 to VCC+0.5	V
Input voltage for Constant-Voltage setting	VLIM	-0.5 to VCC+0.5	-	-0.5 to VM+0.5	-0.5 to VM+0.5	V
Input voltage for Constant-Current setting	CLIM	-	-0.5 to VCC+0.5	-	-	V
Power dissipation	Pd	510 <sup>*1</sup>	430 <sup>*2</sup>	730 <sup>*3</sup>	730 <sup>*3</sup>	mW
Operating temperature range	Topr	-25 to +85	-25 to +85	-25 to +85	-25 to +85	°C
Junction temperature	Tjmax	+150	+125	+150	+150	°C
Storage temperature range	Tstg	-55 to +150	-55 to +125	-55 to +150	-55 to +150	°C
H-bridge output current	Iout	-200 to +200 <sup>*4</sup>	-300 to +300 <sup>*5</sup>	-200 to +200 <sup>*4</sup>	-500 to +500 <sup>*4</sup>	mA

<sup>\*1</sup> Reduced by 4.08mW/°C over 25°C, when mounted on a glass epoxy board (50mm × 58mm × 1.75mm; 8 layers).

<sup>\*2</sup> Reduced by 4.30mW/°C over 25°C, when mounted on a glass epoxy board (50mm × 58mm × 1.75mm; 8 layers).

<sup>\*3</sup> Reduced by 5.84mW/°C over 25°C, when mounted on a glass epoxy board (50mm × 58mm × 1.75mm; 8 layers).

<sup>\*4</sup> Must not exceed Pd, ASO, or Tjmax of 150°C.

<sup>\*5</sup> Must not exceed Pd, ASO, or Tjmax of 125°C.

● Operating Conditions

Parameter	Symbol	Limit				Unit
		BD6883GUL	BH6453GUL	BD6886GUL	BD6369GUL	
Power supply voltage	VCC	+2.5 to +5.5	+2.3 to +3.6	+2.5 to +5.5	+2.5 to +5.5	V
Motor power supply voltage	VM	-	-	+2.5 to +5.5	+2.5 to +5.5	V
Control input voltage	VIN	0 to VCC	0 to VCC	0 to VCC	0 to VCC	V
Input voltage for Constant-Voltage setting	VLIM	0 to VCC	-	0 to VM	0 to VM	V
Input voltage for Constant-Current setting	CLIM	-	0 to VCC	-	-	V
H-bridge output current	Iout	-150 to +150 <sup>*6</sup>	-200 to +200 <sup>*6</sup>	-150 to +150 <sup>*6</sup>	-400 to +400 <sup>*6</sup>	mA

<sup>\*6</sup> Must not exceed Pd or ASO.

● Power Dissipation Reduction

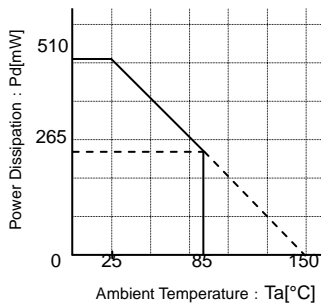

Fig.1 BD6883GUL Power Dissipation Reduction

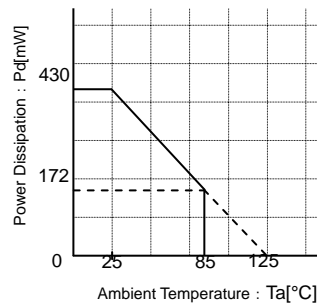

Fig.2 BH6453GUL Power Dissipation Reduction

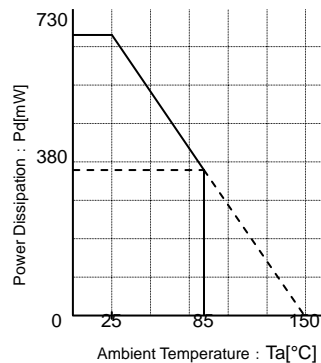

Fig.3 BD6886GUL Power Dissipation Reduction

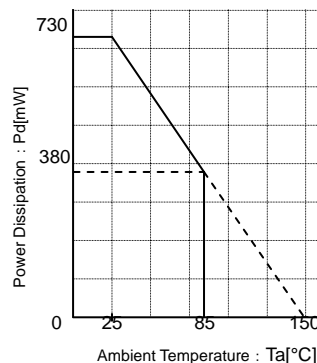

Fig.4 BD6369GUL Power Dissipation Reduction

●Electrical Characteristics

1) BD6883GUL Electrical Characteristics (Unless otherwise specified, Ta=25°C, VCC=3.0V)

Parameter	Symbol	Limit			Unit	Conditions
		Min	Typ	Max		
Overall						
Circuit current during standby operation	ICCST	-	0	10	μA	PS=0V
Circuit current	ICC	-	0.9	1.4	mA	PS=3V, VLIM=3V with no signal and load
Control input (VIN=IN, PS)						
High level input voltage	VINH	2.0	-	VCC	V	
Low level input voltage	VINL	0	-	0.7	V	
High level input current	IINH	15	30	60	μA	VINH=3V, pull-down resistor typ.100kΩ
Low level input current	IINL	-1	0	-	μA	VINL=0V
Input for Constant-Voltage setting						
Input current	IVLIM	-1.5	-0.5	-	μA	VLIM=0V
UVLO						
UVLO voltage	VUVLO	1.6	-	2.4	V	
Constant-Voltage Drive block						
PMOS Output ON-Resistance	RONP	-	0.65	0.80	Ω	Io=-150mA
NMOS Output ON-Resistance	RONN	-	0.40	0.60	Ω	Io=+150mA
Output high-level voltage	VOH	1.9 × VLIM	2.0 × VLIM	2.1 × VLIM	V	VLIM=1V with 10Ω load
Output AC characteristic						
Turn-on time	ton	-	1.5	5	μs	Io=-150mA, 10Ω load
Turn-off time	toff	-	0.1	2	μs	Io=-150mA, 10Ω load
Rise time	tr	-	1.5	8	μs	Io=-150mA, 10Ω load
Fall time	tf	-	0.05	1	μs	Io=-150mA, 10Ω load

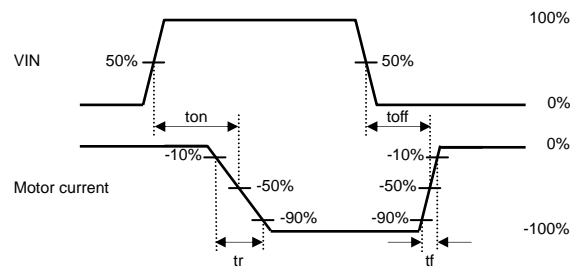

Fig.5 BD6883GUL I/O Switching Waveform  
(The direction flowing into IC is plus)

## 2) BH6453GUL Electrical Characteristics (Unless otherwise specified, Ta=25°C, VCC=3.0V)

Parameter	Symbol	Limit			Unit	Conditions
		Min	Typ	Max		
Overall						
Circuit current during standby operation	ICCST	-	0	5	μA	PS=0V
Circuit current	ICC	-	0.9	1.3	mA	PS=3V, IN=3V, no load
Control input (VIN=IN, PS)						
High-level input voltage	VINH	1.5	-	VCC	V	
Low-level input voltage	VINL	0	-	0.5	V	
High-level input current	IINH	15	30	60	μA	VINH=3V, pull down resistance typ.100kΩ
Low-level input current	IINL	-1	0	-	μA	VINL=0V
UVLO						
UVLO voltage	VUVLO	1.6	-	2.2	V	
Constant-Current Drive block						
PMOS Output ON-Resistance	RONP	-	1.2	1.5	Ω	Io=-200mA
NMOS Output ON-Resistance	RONN	-	0.35	0.50	Ω	Io=+200mA
Offset current	Iofs	0	1	5	mA	CLIM=0V
Output current	Iout	180	200	220	mA	CLIM=0.8V, RL=10Ω

Drive system of Constant-Current

$$I_{SINK}[A] = \frac{CLIM[V]}{2 \times 2.0(Typ.)[\Omega]}$$

$\left\{ \begin{array}{l} I_{SINK}: \text{VCC-OUT current} \\ CLIM: \text{VCC-OUT current setting voltage} \\ R_{RNF}: \text{VCC-OUT current detection resistance} \end{array} \right.$

3) BD6886GUL, BD6369GUL Electrical Characteristics (Unless otherwise specified, Ta=25°C, VCC=3.0V, VM=5.0V)

Parameter	Symbol	Limit			Unit	Conditions
		Min	Typ	Max		
Overall						
Circuit current during standby operation	ICCST	-	0	10	μA	PS=0V
Circuit current 1	ICC	-	0.9	1.4	mA	PS=3V, with no signal
Circuit current 2	IM	-	0.4	0.65	mA	PS=3V, VLIM=5V, no load
Control input (VIN=INA, INB, SEL, PS)						
High-level input voltage	VINH	2.0	-	VCC	V	
Low-level input voltage	VINL	0	-	0.7	V	
High-level input current	IINH	15	30	60	μA	VINH=3V
Low-level input current	IINL	-1	0	-	μA	VINL=0V
Pull-down resistor	RIN	50	100	200	kΩ	
Input for Constant-Voltage setting						
Input current	IVLIM	-1.5	-0.5	-	μA	VLIM=0V
UVLO						
UVLO voltage	VUVLO	1.6	-	2.4	V	
Constant-Voltage Drive block						
Output ON-Resistance	RON	-	0.80	1.20	Ω	Io= ± 150mA on high and low sides in total
Output high-level voltage	VOH	1.9 × VLIM	2.0 × VLIM	2.1 × VLIM	V	VLIM=1V with 10Ω load
Output AC characteristic						
Turn-on time	ton	-	1.5	5	μs	Io= ± 150mA with 10Ω load
Turn-off time	toff	-	0.1	2	μs	Io= ± 150mA with 10Ω load
Rise time	tr	-	2	8	μs	Io= ± 150mA with 10Ω load
Fall time	tf	-	0.05	1	μs	Io= ± 150mA with 10Ω load

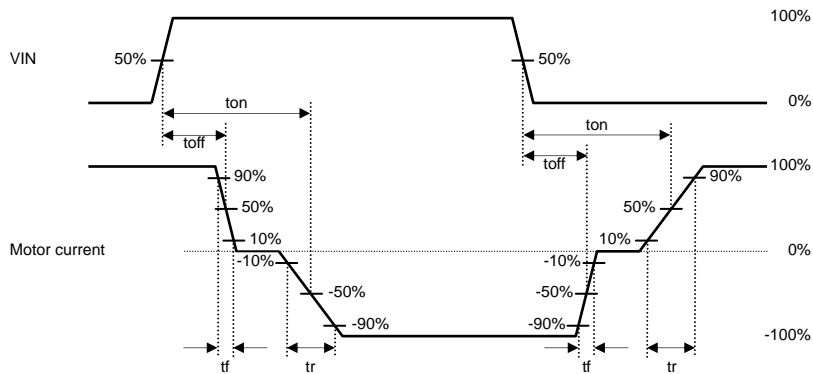

Fig.6 BD6886GUL, BD6369GUL I/O Switching Waveform

● Electrical Characteristic Diagrams

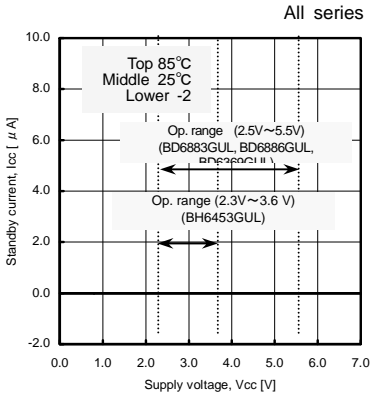

Fig.7 Standby Current (All series)

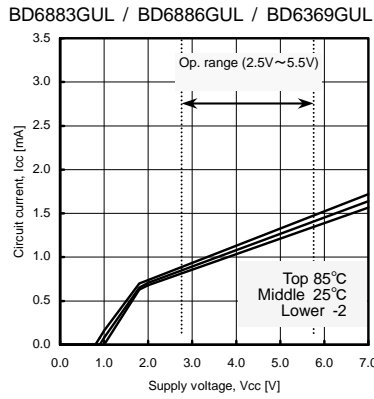

Fig.8 Circuit Current (BD6883GUL/BD6886GUL/BD6369GUL)

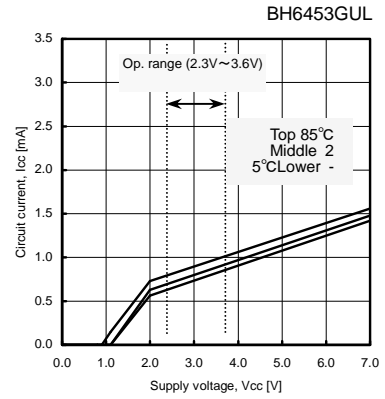

Fig.9 Circuit Current (BH6453GUL)

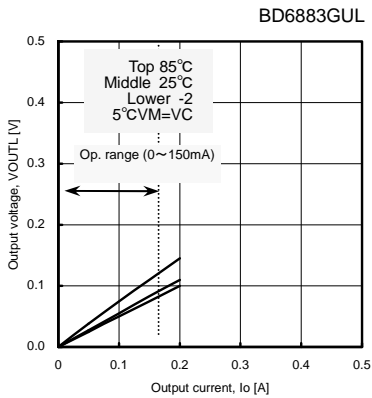

Fig.10 NMOS Output Voltage (BD6883GUL)

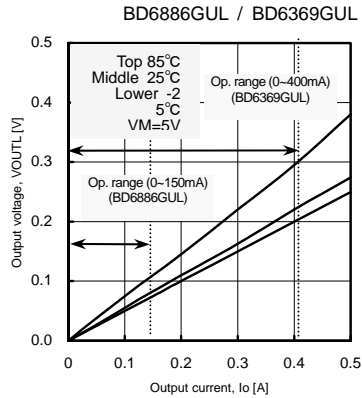

Fig.11 NMOS Output Voltage (BD6886GUL / BD6369GUL)

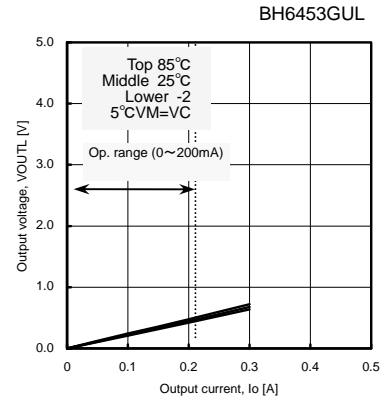

Fig.12 NMOS Output Voltage (BH6453GUL)

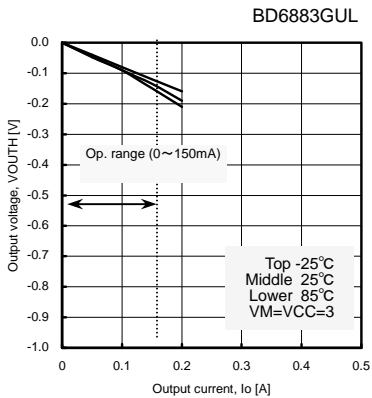

Fig.13 PMOS Output Voltage (BD6883GUL)

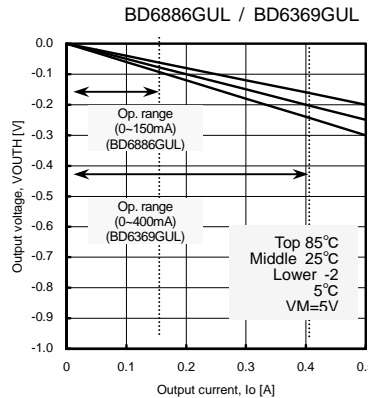

Fig.14 PMOS Output Voltage (BD6886GUL / BD6369GUL)

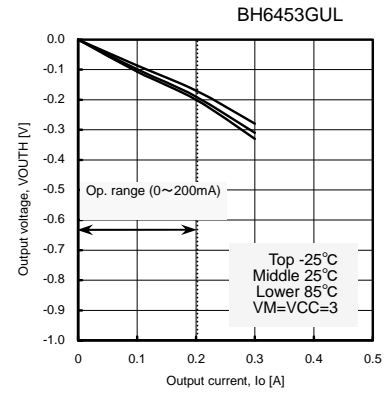

Fig.15 PMOS Output Voltage (BH6453GUL)

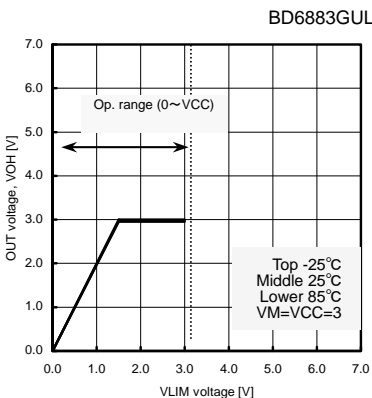

Fig.16 Output High-Level Voltage (BD6883GUL)

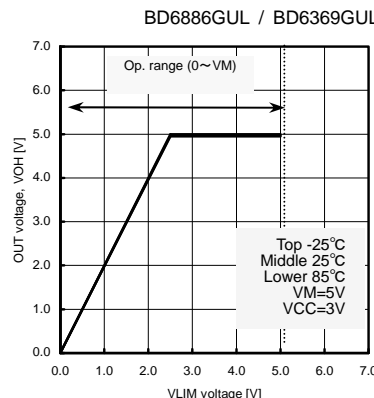

Fig.17 Output High-Level Voltage (BD6886GUL / BD6369GUL)

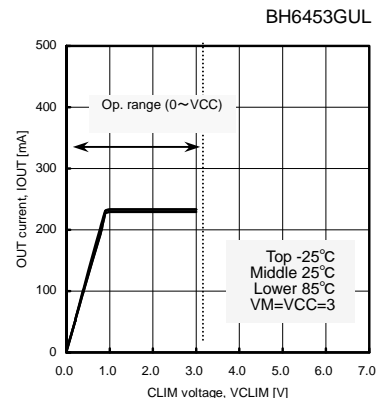

Fig.18 Current Limit Output Voltage (BH6453GUL)

● Block Diagram, Application Circuit Diagram, Pin Arrangement, Pin Function Table

1) BD6883GUL Block Diagram, Application Circuit Diagram, Pin Arrangement, Pin Function Table

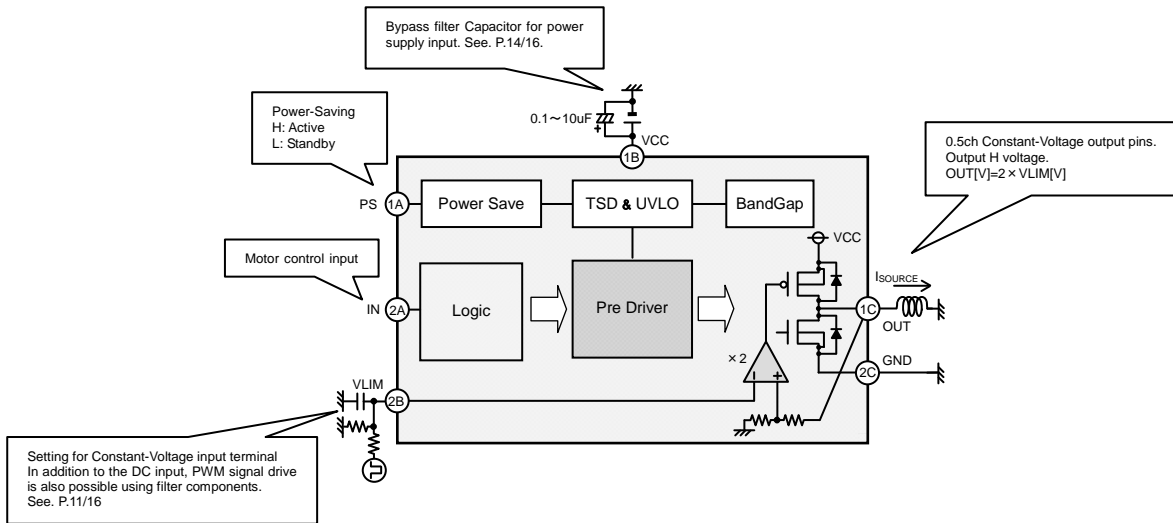

Fig.19 BD6883GUL Block Diagram, Application Circuit Diagram

	1	2
A	PS	IN
B	VCC	VLIM
C	OUT	GND

Fig.20 BD6883GUL Pin Arrangement (Top View)

BD6883GUL Pin Function Table

No.	Pin Name	Function	No.	Pin Name	Function
1A	PS	Power-saving pin	2B	VLIM	Output high-level voltage setting pin
2A	IN	Control input pin	1C	OUT	Half-bridge output pin
1B	VCC	Power supply pin	2C	GND	Ground pin

2) BH6453GUL Block Diagram, Application Circuit Diagram, Pin Arrangement, Pin Function Table

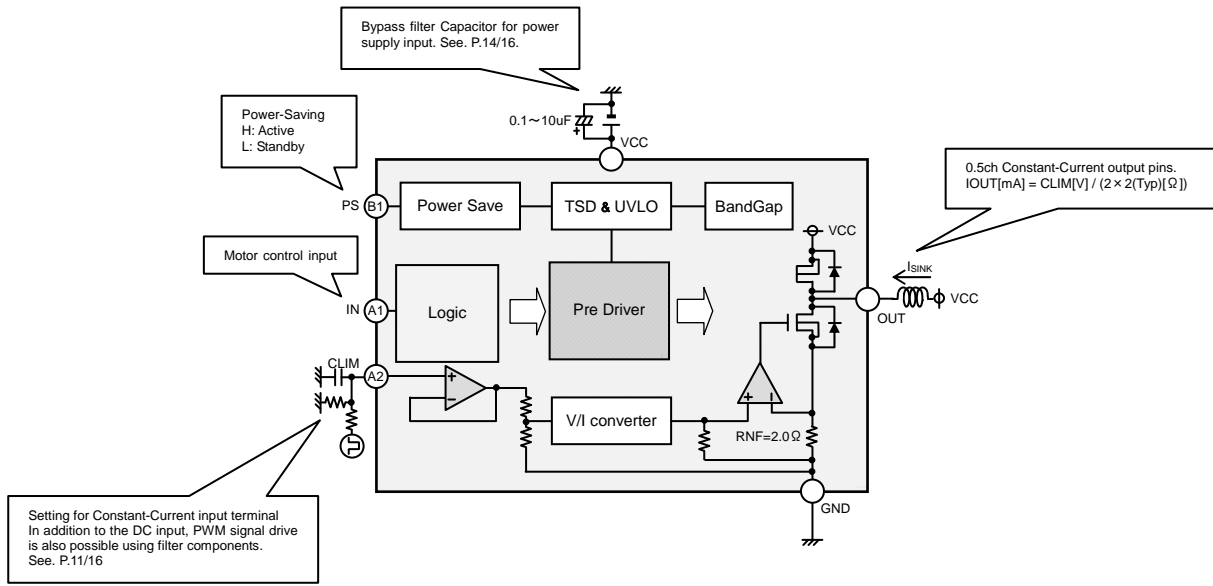

Fig.21 BH6453GUL Block Diagram, Application Circuit Diagram

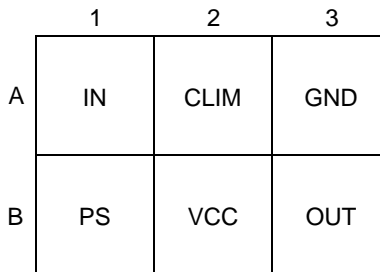

Fig.22 BH6453GUL Pin Arrangement (Top View)

BH6453GUL Pin Function Table

No.	Pin Name	Function	No.	Pin Name	Function
1A	IN	Control input pin	1B	PS	Power-saving pin
2A	CLIM	Output current setting pin	2B	VCC	Power supply pin
3A	GND	Ground pin	3B	OUT	Half-bridge output pin



3) BD6886GUL, BD6369GUL Block Diagram, Application Circuit Diagram, Pin Arrangement, Pin Function Table

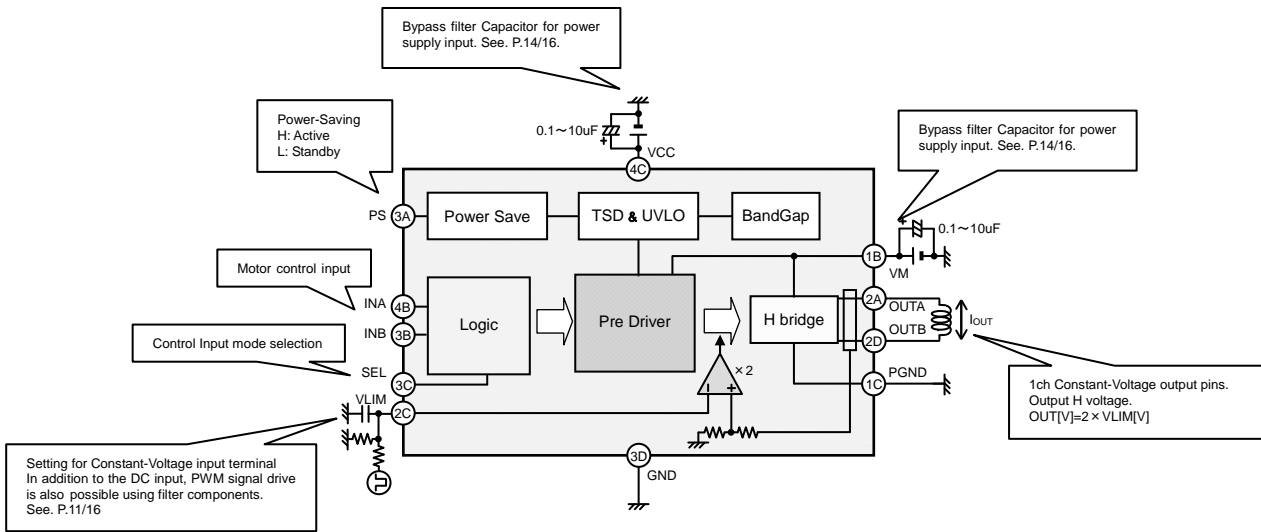

Fig.23 BD6886GUL, BD6369GUL Block Diagram, Application Circuit Diagram

	1	2	3	4
A	N.C.	OUTA	PS	N.C.
B	VM	INDEX POST	INB	INA
C	PGND	VLIM	SEL	VCC
D	N.C.	OUTB	GND	N.C.

Fig.24 BD6886GUL, BD6369GUL Pin Arrangement (Top View)

BD6886GUL, BD6369GUL Pin Function Table

No.	Pin Name	Function	No.	Pin Name	Function
1A	N.C.	N.C.	1C	PGND	Motor ground pin
2A	OUTA	H-bridge output pin A	2C	VLIM	Output high-level voltage setting pin
3A	PS	Power-saving pin	3C	SEL	Control input mode selection pin
4A	N.C.	N.C.	4C	VCC	Power supply pin
1B	VM	Motor power supply pin	1D	N.C.	N.C.
2B			2D	OUTB	H-bridge output pin B
3B	INB	Control input pin B	3D	GND	Ground pin
4B	INA	Control input pin A	4D	N.C.	N.C.

## ●Function Explanation

### 1) Power-saving function (all series)

When the L voltage is applied the PS pin, the IC's inside circuit stop, and when 0V applied, the circuit current became 0 $\mu$ A(Typ.), especially.

When the IC drive, serial input while the PS pin applied H voltage. (See the electrical characteristics; P.3, 4, 5/16)

### 2) Control Input Pin

#### ( I ) IN pin (BD6883GUL, BH6453GUL)

The IN pin is used to program and control the motor drive modes.

(See the electrical characteristics; P3, 4/16, and the I/O Truth Table; P12/16)

#### ( II ) INA, INB, SEL pins (BD6886GUL, BD6369GUL)

The INA and INB are used to program and control the motor drive modes.

When the L voltage is applied to the SEL pin, the I/O logic can be set to EN (Enable)/IN mode, and when the H voltage is applied to the one, the I/O logic can be set to IN/IN mode. (See the electrical characteristics; P5/16, and the I/O Truth Table; P12/16)

### 3) H-bridge and Half-bridge on the output stage (ALL series)

Specify maximum current applied to the H-bridge and Half-bridge within the operating range, in consideration of power dissipation. (See the Operating Conditions; P.2/16)

### 4) Drive system of Linear Constant-Voltage H-bridge (BD6883GUL, BD6886GUL, and BD6369GUL)

To set up the output H voltage, when the voltage input to the VLIM pin, the output H voltage is two times as high as the voltage.

( I ) BD6883GUL  
The output H voltage  $VOH [V] = 2.0 \times VLIM [V]$  (When  $VLIM [V] > \frac{VCC [V]}{2}$ , Output H voltage is about VCC voltage) .....①

( II ) BD6886GUL, BD6369GUL  
The output H voltage  $VOH [V] = 2.0 \times VLIM [V]$  (When  $VLIM [V] > \frac{VM [V]}{2}$ , Output H voltage is about VM voltage) .....②

For example, the output voltage is  $2.0V \pm 5\%$ , if 1.0V is applied to the VLIM pin.

If the VLIM pin is shorted to the VM pin (or the same voltage level as the VM is applied), you can be used as a Full-ON Drive H-bridge.

### 5) Drive system of Linear Constant-Current H-bridge (BH6453GUL)

To detect the output current and the output current settings

The BH6453GUL built in resistor for output current detect. The output current is kept constant by comparing it with the CLIM voltage. In addition, impress a highly accurate voltage form the outside of IC to the CLIM terminal, when you do the output current setting accuracy or more good.

$$\text{Output current } I_{\text{SINK}} [A] = \frac{\text{CLIM [V]}}{2 \times 2(\text{Typ}) [\Omega]} \quad \dots\dots\textcircled{3}$$

If the CLIM pin applied 0.8V, Output current is 200mA  $\pm 10\%$ .

7) Setting of PWM signal input VLIM and CLIM terminals (all series)

It is also possible to compose filters outside the IC, change an input voltage for output voltage and output current setting terminals such as VLIM and CLIM terminals by the DUTY control using a PWM signal, etc., and use them as set values for control. In this case, however, ensure the smoothing of the signals, heeding the constant number of the low-pass filter as stated below. A cutoff frequency  $F_C$  (-3dB attenuation frequency) of the low-pass filter in Fig25 is calculated by the formula mentioned below.

$$\text{Cutoff frequency } F_C [\text{Hz}] = \frac{1}{2\pi C_{IN} (R_{INA} // R_{INB})} [\text{Hz}] \quad \dots\dots ④$$

Set the cutoff frequency  $F_C$  at 1/100 or below of the PWM frequency  $F_{PWM}$ .

For example, if the cutoff frequency  $F_C$  is set at 1/100 of  $F_{PWM}$  when the PWM frequency  $F_{PWM}=50[\text{kHz}]$ , according to the formula above:

$$\text{Cutoff frequency } F_C [\text{Hz}] = \frac{1}{2\pi C_{IN} (R_{INA} // R_{INB})} = \frac{1}{100} \times F_{PWM} = \frac{50 \times 10^3}{100} [\text{Hz}] \quad \dots\dots ⑤$$

When  $C_{IN}=0.1[\mu\text{F}]$ , according to the formula above:

$$R_{INA} // R_{INB} = 3.2[\text{k}\Omega] \quad \dots\dots ⑥$$

Where, an effective value of PWM signal as a DC current, according to crest values  $V_{MAX}$  and ON DUTY [%] =  $\frac{\text{ON time}}{\text{ON time} + \text{OFF time}}$  is as follows:

$$V_{PWM} [\text{V}] = V_{MAX} [\text{V}] \times \text{ON DUTY} [\%] \quad \dots\dots ⑦$$

An actual voltage  $V_{LIM}$  input to terminals that specify output current and voltages, such as VLIM and CLIM terminals is as follows according to resistance potential division of  $R_{INA}$  and  $R_{INB}$ :

$$V_{LIM} [\text{V}] = \frac{R_{INB}}{R_{INA} + R_{INB}} \times V_{PWM} [\text{V}] \quad \dots\dots ⑧$$

For example, when an PWM signal with crest values  $V_{MAX}=3[\text{V}]$  and DUTY [%]=5[%] is input, a  $V_{LIM}$  value according to the formula above is:

$$V_{LIM} [\text{V}] = \frac{R_{INB}}{R_{INA} + R_{INB}} \times 3[\text{V}] \times 50[\%] \quad \dots\dots ⑨$$

( I ) BD6883GUL, BD6886GUL, and BD6369GUL

Where, to specify an output voltage  $V_{OH}=2[\text{V}]$ , a value  $V_{LIM}=1.0[\text{V}]$  according to the formula in the previous page. And then, according to the formula above,  $V_{LIM}=1.0[\text{V}]$ .

$$V_{LIM}=1.0[\text{V}] = V_{LIM} = \frac{R_{INB}}{R_{INA} + R_{INB}} \times 3[\text{V}] \times 50[\%]$$

Therefore,  $R_{INA}=0.5R_{INB}$  .....

⑩

According to ⑥ and ⑩,  $R_{INA}=4.8\text{k}\Omega$ ,  $R_{INB}=9.6\text{k}\Omega$ .

( II ) BH6453GUL

Where, to specify an output current  $I_{SINK}=100[\text{mA}]$ , the following formula is derived according to the formula in the previous page ③,  $CLIM=0.4[\text{V}]$ , and according to the formula above ⑨:

$$CLIM=0.4[\text{V}] = V_{LIM} = \frac{R_{INB}}{R_{INA} + R_{INB}} \times 3[\text{V}] \times 50[\%]$$

$$R_{INA} = 2.75R_{INB} \quad \dots\dots ⑪$$

According to ⑥ and ⑪:  $R_{INA}=11.9\text{k}\Omega$ ,  $R_{INB}=4.3\text{k}\Omega$

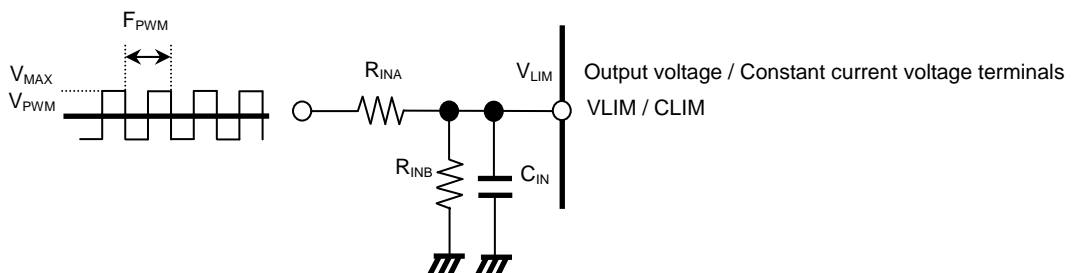

Fig.25 Example PWM signal input

## ● I/O Truth Table

BD6883GUL I/O Truth Table

MODE	INPUT		OUTPUT	OUTPUT MODE
	PS	IN	OUT	
-	H	L	L	Sink
		H	H	Source
-	L	X	Z <sup>*7</sup>	Standby

L: Low, H: High, X: Don't care, Z: Hi impedance

Sink is a direction of current flowing into the driver, and Source is a direction of current flowing out the driver.

When it is sink, which drive FULL ON.

\*<sup>7</sup>Z at the Constant-Voltage driver output L voltage for connect feedback resistance (20kΩ Typ.) for output H voltage setting between OUT pin and GND.  
But output Power MOS is OFF condition.

BH6453GUL I/O Truth Table

MODE	INPUT		OUTPUT	OUTPUT MODE
	PS	IN	OUT	
-	H	H	L	Sink
		L	H	Source
-	L	X	Z	Standby

L: Low, H: High, X: Don't care, Z: Hi impedance

Sink is a direction of current flowing into the driver, and Source is a direction of current flowing out the driver.

When it is source, which drive FULL ON.

BD6886GUL, BD6369GUL I/O Truth Table

MODE	INPUT				OUTPUT		OUTPUT MODE
	PS	SEL	INA	INB	OUTA	OUTB	
EN/IN	H	L	L	X	Z <sup>*7</sup>	Z <sup>*7</sup>	Standby
			H	L	H	L	Forward rotation
			H	H	L	H	Reverse rotation
IN/IN	H	H	L	L	L	L	Brake
			L	H	L	H	Reverse rotation
			H	L	H	L	Forward rotation
			H	H	Z <sup>*8</sup>	Z <sup>*8</sup>	Standby
-	L	X	X	X	Z <sup>*8</sup>	Z <sup>*8</sup>	Standby

L: Low, H: High, X: Don't care, Z: Hi impedance

At forward rotation, current flows from OUTA to OUTB. At reverse rotation, current flows from OUTB to OUTA.

\*<sup>8</sup>Z at the Constant-Voltage driver output L voltage for connect feedback resistance (20kΩ Typ.) for output H voltage setting between OUT pin and GND.  
But output Power MOS is OFF condition.

● I/O Circuit Diagram

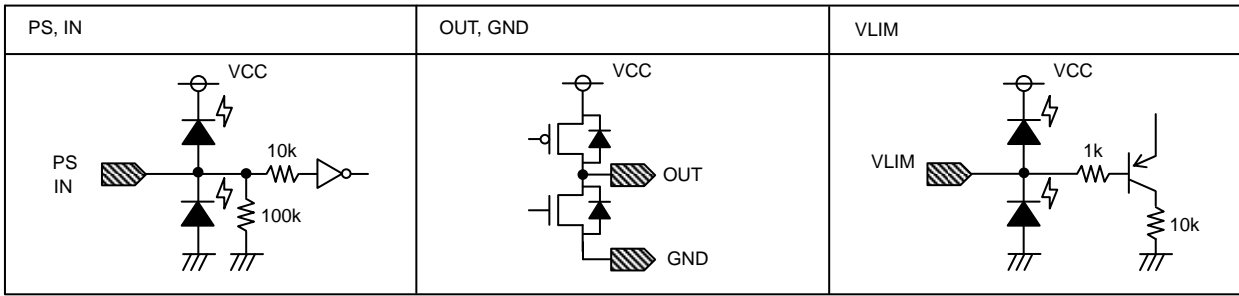

Fig.26 BD6883GUL I/O Circuit Diagram (Resistance values are typical ones.)

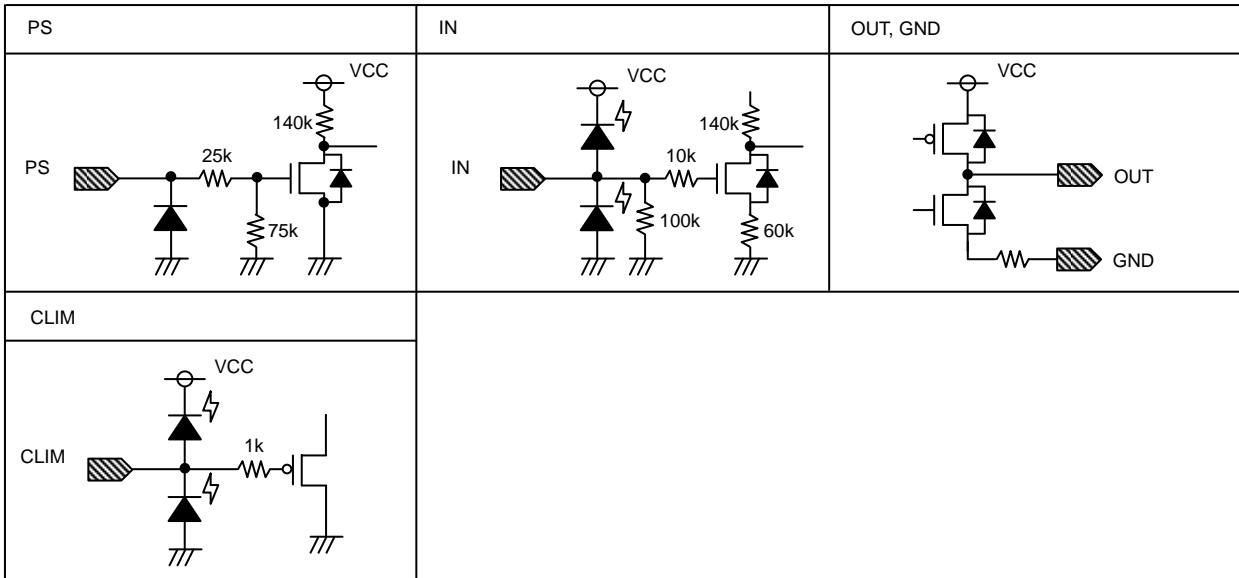

Fig.27 BH6453GUL I/O Circuit Diagram (Resistance values are typical ones.)

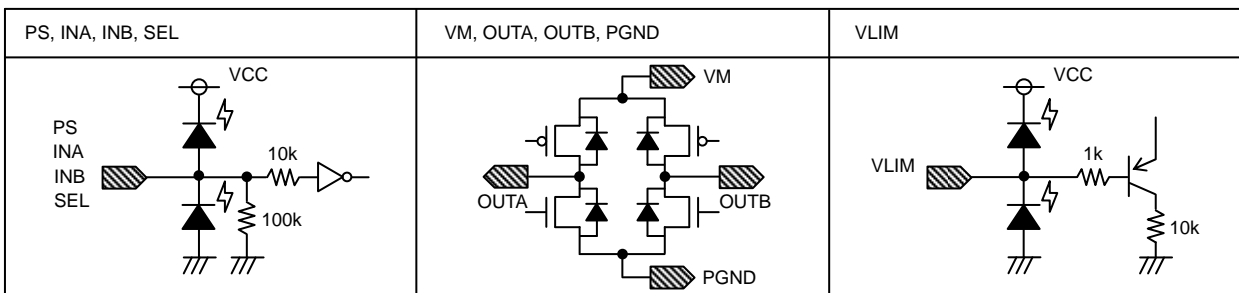

Fig.28 BD6886GUL, BD6369GUL I/O Circuit Diagram (Resistance values are typical ones.)

## ● Operation Notes

- 1) Absolute maximum ratings  
Use of the IC in excess of absolute maximum ratings, such as the applied voltage (VCC, VM) or operating temperature range (Topr), may result in IC damage. Assumptions should not be made regarding the state of the IC (short mode or open mode) when such damage is suffered. A physical safety measure, such as a fuse, should be implemented when using the IC at times where the absolute maximum ratings may be exceeded.
- 2) Storage temperature range (Tstg)  
As long as the IC is kept within this range, there should be no problems in the IC's performance. Conversely, extreme temperature changes may result in poor IC performance, even if the changes are within the above range.
- 3) Power supply and wiring  
Be sure to connect the power terminals outside the IC. Do not leave them open. Because a return current is generated by a counter electromotive force of the motor, take necessary measures such as putting a Capacitor between the power source and the ground as a passageway for the regenerative current. Be sure to connect a Capacitor of proper capacitance (0.1 $\mu$ F to 10 $\mu$ F) between the power source and the ground at the foot of the IC, and ensure that there is no problem in properties of electrolytic Capacitors such as decrease in capacitance at low temperatures. When the connected power source does not have enough current absorbing capability, there is a possibility that the voltage of the power source line increases by the regenerative current and exceeds the absolute maximum rating of this product and the peripheral circuits.  
Therefore, be sure to take physical safety measures such as putting a zener diode for a voltage clamp between the power source and the ground.
- 4) Ground terminal and wiring  
The potential at GND terminals should be made the lowest under any operating conditions. Ensure that there are no terminals where the potentials are below the potential at GND terminals, including the transient phenomena. The motor ground terminals PGND, and the small signal ground terminal GND are not interconnected with one another inside the IC. It is recommended that you should isolate the large-current RNF pattern and PGND pattern from the small-signal GND pattern, and should establish a one-point grounding at a reference point of the set, to avoid fluctuation of small-signal GND voltages caused by voltage changes due to pattern wire resistances and large currents. Also prevent the voltage variation of the ground wiring patterns of external components. Use short and thick power source and ground wirings to ensure low impedance.
- 5) Thermal design  
Use a proper thermal design that allows for a sufficient margin of the power dissipation (Pd) at actual operating conditions.
- 6) Pin short and wrong direction assembly of the device.  
Use caution when positioning the IC for mounting on printed circuit boards. The IC may be damaged if there is any connection error or if positive and ground power supply terminals are reversed. The IC may also be damaged if pins are shorted together or are shorted to other circuit's power lines.
- 7) Avoiding strong magnetic field  
Malfunction may occur if the IC is used around a strong magnetic field.
- 8) ASO  
Ensure that the output transistors of the motor driver are not driven under excess conditions of the absolute maximum ratings and ASO.
- 9) TSD (Thermal Shut Down) circuit  
If the junction temperature (Tjmax) reaches 175°C (but the BH6453GUL is 150°C), the TSD circuit will operate, and the coil output circuit of the motor will open. There is a temperature hysteresis of approximately 25°C (but the BH6453GUL is 20°C). The TSD circuit is designed only to shut off the IC in order to prevent runaway thermal operation. It is not designed to protect the IC or guarantee its operation. The performance of the IC's characteristics is not guaranteed and it is recommended that the device is replaced after the TSD is activated.

- 10) Testing an application board  
 When testing the IC on an application board, connecting a Capacitor to a pin with low impedance subjects the IC to stress. Always discharge Capacitors after each process or step. Always turn the IC's power supply off before connecting it to, or removing it from a jig or fixture, during the inspection process. Ground the IC during assembly steps as an antistatic measure. Use similar precaution when transporting and storing the IC.

- 11) Regarding the input pin of the IC  
 This monolithic IC contains P<sup>+</sup> isolation and P substrate layers between adjacent elements to keep them isolated. P-N junctions are formed at the intersection of these P layers with the N layers of other elements, creating a parasitic diode or transistor. For example, the relation between each potential is as follows:

When GND > Pin A, the P-N junction operates as a parasitic diode.

When GND > Pin B, the P-N junction operates as a parasitic diode and transistor.

Parasitic elements can occur inevitably in the structure of the IC. The operation of parasitic elements can result in mutual interference among circuits, operational faults, or physical damage. Accordingly, methods by which parasitic elements operate, such as applying a voltage that is lower than the GND (P substrate) voltage to an input pin, should not be used.

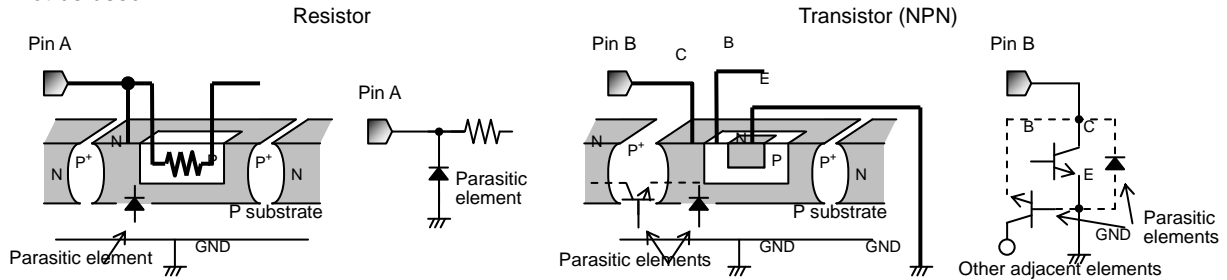

Fig.29 Example of Simple IC Architecture

●Selecting a Model Name when Ordering

B X 6 X X X G U L

E 2

Rohm model name

Package

Packaging and forming specification  
E2: Embossed tape and reel

6883 : Constant voltage 0.5ch  
6453 : Constant current 0.5ch  
6886 : Constant voltage 1ch  
6369 : Constant voltage 1ch

GUL : VCSP50L1 (BD6883)  
GUL : VCSP50L1 (BH6453)  
GUL : VCSP50L2 (BD6886)  
GUL : VCSP50L2 (BD6369)

VCSP50L1 (BD6883GUL)

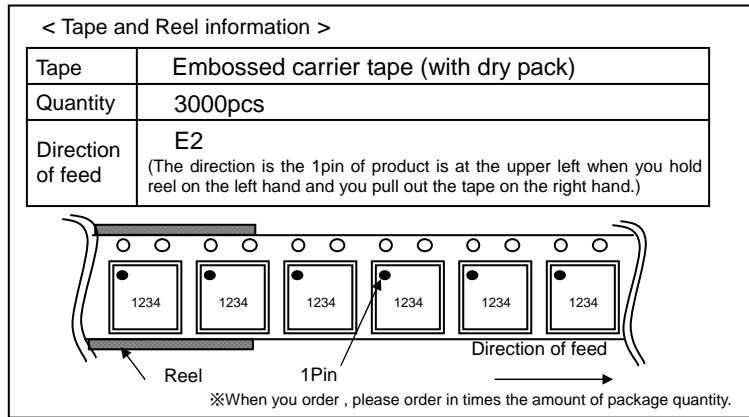
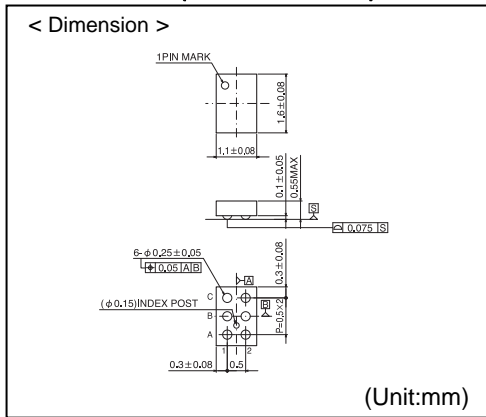

VCSP50L1 (BH6453GUL)

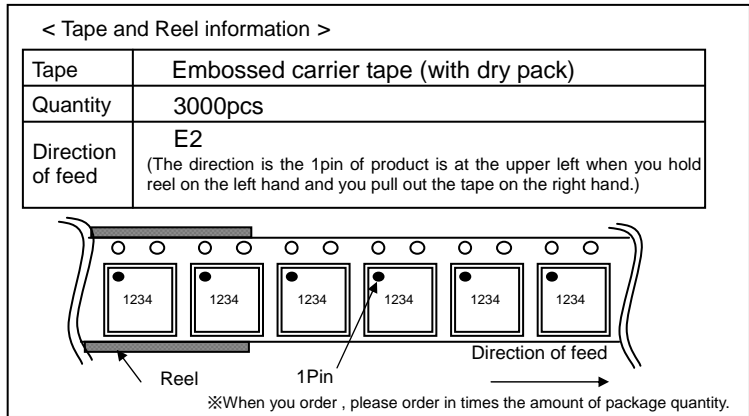
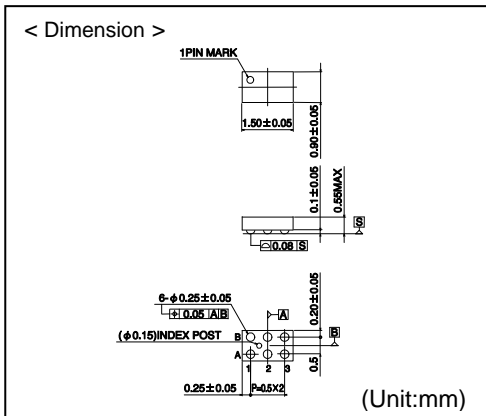

VCSP50L2 (BD6886GUL, BD6369GUL)

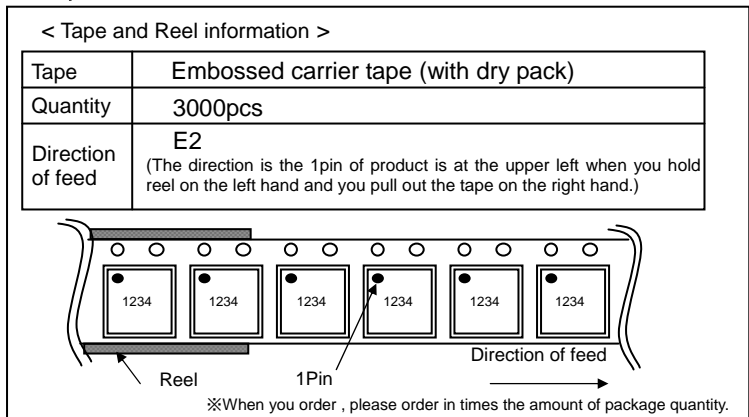
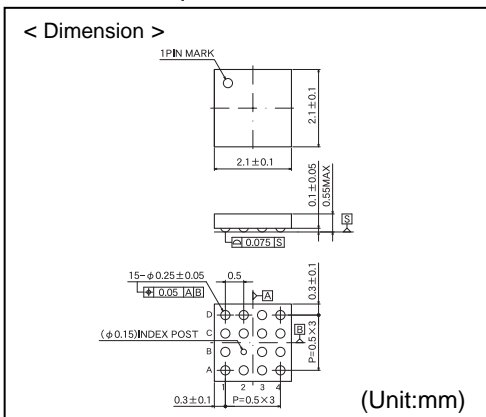



# Notice

## Precaution on using ROHM Products

- Our Products are designed and manufactured for application in ordinary electronic equipments (such as AV equipment, OA equipment, telecommunication equipment, home electronic appliances, amusement equipment, etc.). If you intend to use our Products in devices requiring extremely high reliability (such as medical equipment <sup>(Note 1)</sup>, transport equipment, traffic equipment, aircraft/spacecraft, nuclear power controllers, fuel controllers, car equipment including car accessories, safety devices, etc.) and whose malfunction or failure may cause loss of human life, bodily injury or serious damage to property ("Specific Applications"), please consult with the ROHM sales representative in advance. Unless otherwise agreed in writing by ROHM in advance, ROHM shall not be in any way responsible or liable for any damages, expenses or losses incurred by you or third parties arising from the use of any ROHM's Products for Specific Applications.

(Note1) Medical Equipment Classification of the Specific Applications

JAPAN	USA	EU	CHINA
CLASS III	CLASS III	CLASS II b	CLASS III
CLASS IV		CLASS III	

- ROHM designs and manufactures its Products subject to strict quality control system. However, semiconductor products can fail or malfunction at a certain rate. Please be sure to implement, at your own responsibilities, adequate safety measures including but not limited to fail-safe design against the physical injury, damage to any property, which a failure or malfunction of our Products may cause. The following are examples of safety measures:
  - Installation of protection circuits or other protective devices to improve system safety
  - Installation of redundant circuits to reduce the impact of single or multiple circuit failure
- Our Products are designed and manufactured for use under standard conditions and not under any special or extraordinary environments or conditions, as exemplified below. Accordingly, ROHM shall not be in any way responsible or liable for any damages, expenses or losses arising from the use of any ROHM's Products under any special or extraordinary environments or conditions. If you intend to use our Products under any special or extraordinary environments or conditions (as exemplified below), your independent verification and confirmation of product performance, reliability, etc. prior to use, must be necessary:
  - Use of our Products in any types of liquid, including water, oils, chemicals, and organic solvents
  - Use of our Products outdoors or in places where the Products are exposed to direct sunlight or dust
  - Use of our Products in places where the Products are exposed to sea wind or corrosive gases, including Cl<sub>2</sub>, H<sub>2</sub>S, NH<sub>3</sub>, SO<sub>2</sub>, and NO<sub>2</sub>
  - Use of our Products in places where the Products are exposed to static electricity or electromagnetic waves
  - Use of our Products in proximity to heat-producing components, plastic cords, or other flammable items
  - Sealing or coating our Products with resin or other coating materials
  - Use of our Products without cleaning residue of flux (even if you use no-clean type fluxes, cleaning residue of flux is recommended); or Washing our Products by using water or water-soluble cleaning agents for cleaning residue after soldering
  - Use of the Products in places subject to dew condensation
- The Products are not subject to radiation-proof design.
- Please verify and confirm characteristics of the final or mounted products in using the Products.
- In particular, if a transient load (a large amount of load applied in a short period of time, such as pulse. is applied, confirmation of performance characteristics after on-board mounting is strongly recommended. Avoid applying power exceeding normal rated power; exceeding the power rating under steady-state loading condition may negatively affect product performance and reliability.
- De-rate Power Dissipation (Pd) depending on Ambient temperature (Ta). When used in sealed area, confirm the actual ambient temperature.
- Confirm that operation temperature is within the specified range described in the product specification.
- ROHM shall not be in any way responsible or liable for failure induced under deviant condition from what is defined in this document.

## Precaution for Mounting / Circuit board design

- When a highly active halogenous (chlorine, bromine, etc.) flux is used, the residue of flux may negatively affect product performance and reliability.
- In principle, the reflow soldering method must be used; if flow soldering method is preferred, please consult with the ROHM representative in advance.

For details, please refer to ROHM Mounting specification

### Precautions Regarding Application Examples and External Circuits

1. If change is made to the constant of an external circuit, please allow a sufficient margin considering variations of the characteristics of the Products and external components, including transient characteristics, as well as static characteristics.
2. You agree that application notes, reference designs, and associated data and information contained in this document are presented only as guidance for Products use. Therefore, in case you use such information, you are solely responsible for it and you must exercise your own independent verification and judgment in the use of such information contained in this document. ROHM shall not be in any way responsible or liable for any damages, expenses or losses incurred by you or third parties arising from the use of such information.

### Precaution for Electrostatic

This Product is electrostatic sensitive product, which may be damaged due to electrostatic discharge. Please take proper caution in your manufacturing process and storage so that voltage exceeding the Products maximum rating will not be applied to Products. Please take special care under dry condition (e.g. Grounding of human body / equipment / solder iron, isolation from charged objects, setting of ionizer, friction prevention and temperature / humidity control).

### Precaution for Storage / Transportation

1. Product performance and soldered connections may deteriorate if the Products are stored in the places where:
  - [a] the Products are exposed to sea winds or corrosive gases, including Cl<sub>2</sub>, H<sub>2</sub>S, NH<sub>3</sub>, SO<sub>2</sub>, and NO<sub>2</sub>
  - [b] the temperature or humidity exceeds those recommended by ROHM
  - [c] the Products are exposed to direct sunshine or condensation
  - [d] the Products are exposed to high Electrostatic
2. Even under ROHM recommended storage condition, solderability of products out of recommended storage time period may be degraded. It is strongly recommended to confirm solderability before using Products of which storage time is exceeding the recommended storage time period.
3. Store / transport cartons in the correct direction, which is indicated on a carton with a symbol. Otherwise bent leads may occur due to excessive stress applied when dropping of a carton.
4. Use Products within the specified time after opening a humidity barrier bag. Baking is required before using Products of which storage time is exceeding the recommended storage time period.

### Precaution for Product Label

QR code printed on ROHM Products label is for ROHM's internal use only.

### Precaution for Disposition

When disposing Products please dispose them properly using an authorized industry waste company.

### Precaution for Foreign Exchange and Foreign Trade act

Since our Products might fall under controlled goods prescribed by the applicable foreign exchange and foreign trade act, please consult with ROHM representative in case of export.

### Precaution Regarding Intellectual Property Rights

1. All information and data including but not limited to application example contained in this document is for reference only. ROHM does not warrant that foregoing information or data will not infringe any intellectual property rights or any other rights of any third party regarding such information or data. ROHM shall not be in any way responsible or liable for infringement of any intellectual property rights or other damages arising from use of such information or data.:
2. No license, expressly or implied, is granted hereby under any intellectual property rights or other rights of ROHM or any third parties with respect to the information contained in this document.

### Other Precaution

1. This document may not be reprinted or reproduced, in whole or in part, without prior written consent of ROHM.
2. The Products may not be disassembled, converted, modified, reproduced or otherwise changed without prior written consent of ROHM.
3. In no event shall you use in any way whatsoever the Products and the related technical information contained in the Products or this document for any military purposes, including but not limited to, the development of mass-destruction weapons.
4. The proper names of companies or products described in this document are trademarks or registered trademarks of ROHM, its affiliated companies or third parties.

**General Precaution**

1. Before you use our Products, you are requested to carefully read this document and fully understand its contents. ROHM shall not be in any way responsible or liable for failure, malfunction or accident arising from the use of any ROHM's Products against warning, caution or note contained in this document.
2. All information contained in this document is current as of the issuing date and subject to change without any prior notice. Before purchasing or using ROHM's Products, please confirm the latest information with a ROHM sales representative.
3. The information contained in this document is provided on an "as is" basis and ROHM does not warrant that all information contained in this document is accurate and/or error-free. ROHM shall not be in any way responsible or liable for any damages, expenses or losses incurred by you or third parties resulting from inaccuracy or errors of or concerning such information.

# Mouser Electronics

Authorized Distributor

Click to View Pricing, Inventory, Delivery & Lifecycle Information:

[ROHM Semiconductor:](#)

[BD6369GUL-E2](#)



Компания «ЭлектроПласт» предлагает заключение долгосрочных отношений при поставках импортных электронных компонентов на взаимовыгодных условиях!

Наши преимущества:

- Оперативные поставки широкого спектра электронных компонентов отечественного и импортного производства напрямую от производителей и с крупнейших мировых складов;
- Поставка более 17-ти миллионов наименований электронных компонентов;
- Поставка сложных, дефицитных, либо снятых с производства позиций;
- Оперативные сроки поставки под заказ (от 5 рабочих дней);
- Экспресс доставка в любую точку России;
- Техническая поддержка проекта, помощь в подборе аналогов, поставка прототипов;
- Система менеджмента качества сертифицирована по Международному стандарту ISO 9001;
- Лицензия ФСБ на осуществление работ с использованием сведений, составляющих государственную тайну;
- Поставка специализированных компонентов (Xilinx, Altera, Analog Devices, Intersil, Interpoint, Microsemi, Aeroflex, Peregrine, Syfer, Eurofarad, Texas Instrument, Miteq, Cobham, E2V, MA-COM, Hittite, Mini-Circuits, General Dynamics и др.);

Помимо этого, одним из направлений компании «ЭлектроПласт» является направление «Источники питания». Мы предлагаем Вам помощь Конструкторского отдела:

- Подбор оптимального решения, техническое обоснование при выборе компонента;
- Подбор аналогов;
- Консультации по применению компонента;
- Поставка образцов и прототипов;
- Техническая поддержка проекта;
- Защита от снятия компонента с производства.



#### Как с нами связаться

**Телефон:** 8 (812) 309 58 32 (многоканальный)

**Факс:** 8 (812) 320-02-42

**Электронная почта:** [org@eplast1.ru](mailto:org@eplast1.ru)

**Адрес:** 198099, г. Санкт-Петербург, ул. Калинина, дом 2, корпус 4, литера А.