

# AG606

## Push-Pull CATV Amplifier



### Product Features

- 50 – 1000 MHz
- $\pm 0.7$  dB Gain Flatness
- +20 dBm P1dB
- +37 dBm Output IP3
- +73 dBm Output IP2
- -68 dBc CTB  
+34 dBmV/channel, 79 channels
- -80 dBc CSO  
+34 dBmV/channel, 79 channels
- Matched amplifiers for a push-pull configuration
- +7V Single Positive Supply
- MTTF > 1000 Years

### Product Description

The AG606 is a dual amplifier containing two internal matched amplifiers optimal for a push-pull configuration. The internal amplifiers employ InGaP HBT technology for a cost-effective low-distortion solution.

The AG606 is ideal for drop amplifiers, splitters, and other low to moderate power outside plant CATV applications. The amplifier can also be useful in low power headend applications such as linear laser drivers.

The AG606 has excellent VSWR when used in a 75  $\Omega$  push-pull configuration. It is provided in a low-cost environmentally-friendly lead-free/green/ RoHS-compliant SOIC-8 package.

### Functional Diagram

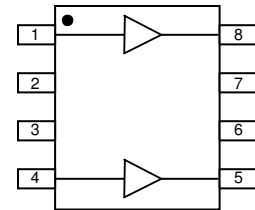

| Function     | Pin No.                     |
|--------------|-----------------------------|
| Amp 1 Input  | 1                           |
| Amp 2 Input  | 4                           |
| Amp 2 Output | 5                           |
| Amp 1 Output | 8                           |
| Ground       | 2, 3, 6, 7, Backside paddle |

### Applications

- CATV Head End Equipment
- CATV Line Amplifiers
- FTTH Repeaters

### Single-ended Device Specifications <sup>(1)</sup>

| Parameter                 | Units | Min   | Typ  | Max  |
|---------------------------|-------|-------|------|------|
| Test Frequency            | MHz   |       | 800  |      |
| Gain                      | dB    | 13.2  | 14.3 | 15.5 |
| Output IP3 <sup>(2)</sup> | dBm   | +33.5 | +36  |      |
| Device Current            | mA    | 76    | 82.5 | 90   |
| Device Voltage            | V     |       | 5.25 |      |

1. Test conditions unless otherwise noted: T = 25 °C, 800 MHz on each individual single-branch amplifier in a 50 $\Omega$  test fixture using a +7V supply and a 20.5  $\Omega$  dropping resistor.
2. 3OIP measured with two tones at an output power of +5 dBm/ tone separated by 1 MHz. The suppression on the largest IM3 product is used to calculate the 3OIP using a 2:1 rule.
3. Typical parameters reflect performance in a push-pull application circuit.
4. Balun, board, and connector losses have not been extracted, but typically account of 0.4 dB loss midband and 1.1 dB loss at 860 MHz.
5. Measured at +34 dBmV/channel, 79 channels Flat Loading.
6. OIP2 is measured at f1 + f2 at +5 dBm / tone.

### Typical Performance <sup>(3)</sup>

| Parameter                   | Units | Typical          |       |       |       |
|-----------------------------|-------|------------------|-------|-------|-------|
| Frequency                   | MHz   | 50               | 250   | 450   | 860   |
| Gain <sup>(4)</sup>         | dB    | 14.3             | 14.2  | 13.9  | 12.9  |
| Input R. L.                 | dB    | 21               | 28    | 18    | 11    |
| Output R. L.                | dB    | 17               | 18    | 16    | 18    |
| CTB <sup>(5)</sup>          | dBc   | -69              | -67   | -67   |       |
| CSO <sup>(5)</sup>          | dBc   | -81              | -87   | -80   |       |
| XMOD <sup>(5)</sup>         | dBc   | -60              | -61   | -60   |       |
| Output P1dB                 | dBm   | +20.7            | +20.5 | +20.3 | +22   |
| Output IP2 <sup>(6)</sup>   | dBm   | +73.6            | +76.1 | +76.4 | +76.6 |
| Output IP3 <sup>(2)</sup>   | dBm   | +37.5            | +37.5 | +37.3 | +39.2 |
| Noise Figure <sup>(4)</sup> | dB    | 5                | 5     | 5.3   | 5.9   |
| Device Bias                 | V     | +5.25 V @ 165 mA |       |       |       |

### Absolute Maximum Rating

| Parameter  | Rating         |
|--|----------------|
| Storage Temperature  | -55 to +125 °C |
| Supply Voltage   | +7 V           |
| RF Input Power (continuous)                                    | +13dBm         |
| Thermal Resistance, Rth  | 63 °C/W        |
| Max Junction Temperature, Tj<br>For 10 <sup>6</sup> hours MTTF | 177 °C         |

Operation of this device above any of these parameters may cause permanent damage.

### Ordering Information

| Part No.  | Description  |
|-----------|--|
| AG606-G   | Push-pull CATV Amplifier<br>(lead-free /Green/ RoHS-compliant SOIC8 Pkg) |
| AG606-PCB | Fully Assembled CATV Evaluation Board                                    |

Standard T/R size = 500 pieces on a 7" reel.

## Typical Device Data – 50Ω Z<sub>0</sub>

S-Parameters ( $V_{dev} = +5.25$  V,  $I_{cc} = 82.5$  mA,  $T = 25$  °C, unmatched 50 ohm system, calibrated to device leads)  
 These represent a single-ended amplifier in the AG606, with there being two matched amplifiers inside the package.

| Freq (MHz) | S11 (dB) | S11 (ang) | S21 (dB) | S21 (ang) | S12 (dB) | S12 (ang) | S22 (dB) | S22 (ang) |
|------------|----------|-----------|----------|-----------|----------|-----------|----------|-----------|
| 50         | -12.03   | 178.56    | 14.61    | 177.32    | -18.85   | -0.01     | -17.45   | 178.57    |
| 100        | -12.09   | 174.32    | 14.61    | 175.28    | -18.74   | -1.56     | -17.08   | 178.23    |
| 150        | -11.81   | 172.20    | 14.62    | 173.13    | -18.76   | -2.21     | -17.28   | 176.63    |
| 200        | -11.81   | 169.91    | 14.59    | 170.74    | -18.81   | -3.25     | -16.86   | 176.45    |
| 250        | -11.64   | 168.30    | 14.62    | 168.67    | -18.77   | -3.74     | -17.24   | 173.88    |
| 300        | -11.79   | 166.47    | 14.63    | 165.71    | -18.81   | -4.12     | -17.00   | 174.14    |
| 350        | -11.76   | 164.70    | 14.68    | 163.24    | -18.79   | -4.96     | -17.20   | 172.40    |
| 400        | -12.02   | 162.35    | 14.59    | 161.23    | -18.84   | -5.99     | -16.85   | 173.24    |
| 450        | -11.92   | 159.27    | 14.48    | 158.25    | -18.82   | -5.99     | -17.02   | 170.87    |
| 500        | -11.92   | 156.13    | 14.53    | 156.14    | -18.80   | -6.63     | -16.70   | 169.98    |
| 550        | -11.77   | 154.71    | 14.48    | 154.05    | -18.86   | -7.58     | -16.78   | 167.35    |
| 600        | -11.75   | 151.64    | 14.52    | 151.45    | -18.79   | -8.02     | -16.47   | 167.79    |
| 650        | -11.67   | 150.04    | 14.45    | 148.59    | -18.74   | -9.17     | -16.49   | 164.94    |
| 700        | -11.89   | 147.47    | 14.41    | 146.59    | -18.83   | -9.41     | -16.48   | 164.76    |
| 750        | -11.72   | 145.07    | 14.43    | 144.30    | -18.89   | -10.48    | -16.43   | 161.86    |
| 800        | -11.76   | 143.08    | 14.33    | 141.92    | -18.87   | -11.22    | -16.23   | 161.91    |
| 850        | -11.56   | 141.20    | 14.36    | 139.40    | -18.87   | -11.88    | -15.86   | 158.92    |
| 900        | -11.65   | 138.97    | 14.26    | 137.14    | -18.80   | -12.23    | -15.78   | 159.88    |
| 950        | -11.57   | 137.28    | 14.28    | 134.86    | -18.79   | -13.52    | -15.51   | 156.89    |
| 1000       | -11.56   | 135.12    | 14.19    | 132.17    | -18.86   | -13.15    | -15.34   | 156.79    |

## Typical Device Data – 50Ω Z<sub>0</sub>

S-Parameters ( $V_{dev} = +5.25$  V,  $I_{cc} = 82.5$  mA,  $T = 25$  °C, unmatched 37.5 ohm system, calibrated to device leads)  
 These represent a single-ended amplifier in the AG606, with there being two matched amplifiers inside the package.

| Freq (MHz) | S11 (dB) | S11 (ang) | S21 (dB) | S21 (ang) | S12 (dB) | S12 (ang) | S22 (dB) | S22 (ang) |
|------------|----------|-----------|----------|-----------|----------|-----------|----------|-----------|
| 50         | -34.66   | 173.49    | 14.79    | 177.27    | -18.66   | -0.06     | -19.98   | -0.57     |
| 100        | -33.64   | 133.95    | 14.81    | 175.12    | -18.54   | -1.71     | -20.40   | -3.63     |
| 150        | -30.17   | 137.29    | 14.82    | 172.89    | -18.56   | -2.45     | -20.15   | -4.04     |
| 200        | -29.21   | 131.02    | 14.80    | 170.45    | -18.60   | -3.54     | -20.91   | -7.28     |
| 250        | -27.90   | 131.37    | 14.83    | 168.30    | -18.57   | -4.11     | -20.34   | -5.91     |
| 300        | -28.12   | 124.34    | 14.84    | 165.33    | -18.61   | -4.51     | -20.82   | -9.61     |
| 350        | -27.59   | 122.31    | 14.88    | 162.80    | -18.59   | -5.40     | -20.57   | -10.25    |
| 400        | -27.52   | 110.86    | 14.79    | 160.77    | -18.65   | -6.45     | -21.33   | -14.80    |
| 450        | -25.69   | 107.75    | 14.68    | 157.66    | -18.62   | -6.58     | -21.31   | -13.74    |
| 500        | -24.49   | 101.63    | 14.73    | 155.45    | -18.61   | -7.32     | -21.94   | -15.66    |
| 550        | -23.76   | 104.95    | 14.68    | 153.27    | -18.66   | -8.35     | -22.13   | -13.89    |
| 600        | -22.84   | 100.16    | 14.72    | 150.61    | -18.59   | -8.86     | -22.79   | -18.83    |
| 650        | -22.46   | 101.72    | 14.65    | 147.66    | -18.53   | -10.10    | -23.13   | -17.61    |
| 700        | -22.06   | 95.00     | 14.60    | 145.62    | -18.64   | -10.38    | -23.54   | -19.44    |
| 750        | -21.15   | 95.84     | 14.62    | 143.20    | -18.70   | -11.58    | -24.06   | -16.74    |
| 800        | -20.79   | 94.07     | 14.53    | 140.77    | -18.68   | -12.37    | -25.05   | -20.60    |
| 850        | -20.09   | 95.55     | 14.56    | 138.11    | -18.67   | -13.17    | -26.61   | -16.06    |
| 900        | -19.78   | 92.24     | 14.45    | 135.83    | -18.60   | -13.53    | -27.43   | -23.50    |
| 950        | -19.42   | 92.70     | 14.48    | 133.44    | -18.59   | -14.94    | -29.28   | -17.34    |
| 1000       | -18.88   | 90.91     | 14.39    | 130.68    | -18.66   | -14.64    | -31.32   | -18.82    |

## Application Circuit PC Board Layout

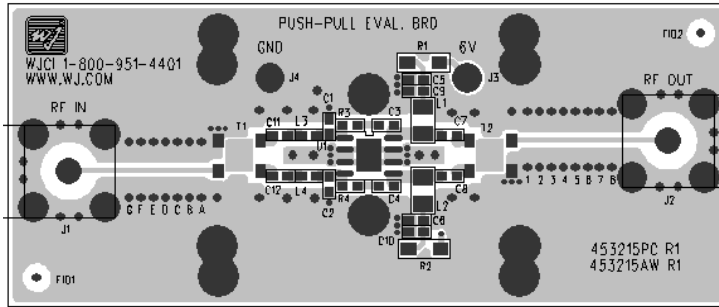

Circuit Board Material: .028" FR4, 4 - layer, 1 oz copper, Microstrip line details: width = .021", spacing = .021". C1, C2, R3, C3, R4 and C4 are shown in the silkscreen but are not required in the schematic.

### Typical RF Performance at 25 °C

| Frequency                   | MHz | 50    | 250   | 450   | 860   |
|-----------------------------|-----|-------|-------|-------|-------|
| Gain <sup>(1)</sup>         | dB  | 14.3  | 14.2  | 13.9  | 12.9  |
| Input R.L.                  | dB  | 21    | 28    | 18    | 11    |
| Output R.L.                 | dB  | 17    | 18    | 16    | 18    |
| CTB <sup>(2)</sup>          | dBc | -69   | -67   | -67   |       |
| CSO <sup>(2)</sup>          | dBc | -81   | -87   | -80   |       |
| XMOD <sup>(2)</sup>         | dBc | -60   | -61   | -60   |       |
| Output P1dB                 | dBm | +20.7 | +20.5 | +20.3 | +22   |
| Output IP2 <sup>(3)</sup>   | dBm | +73.6 | +76.1 | +76.4 | +76.6 |
| Output IP3 <sup>(4)</sup>   | dBm | +37.5 | +37.5 | +37.3 | +39.2 |
| Noise Figure <sup>(1)</sup> | dB  | 5     | 5     | 5.3   | 5.9   |
| Device Current              | mA  | 165   |       |       |       |
| Device Voltage              | V   | +5.25 |       |       |       |

- Balun, board, and connector losses have not been extracted, but typically account for 0.4 dB loss midband and 1.1 dB loss at 860 MHz.
- CSO, CTB, & XMOD are measured at +34 dBmV/channel, 79 channels Flat Loading.
- OIP2 is measured at f1 + f2 at 5 dBm / tone.
- OIP3 is measured at +5 dBm / tone with 1 MHz spacing.

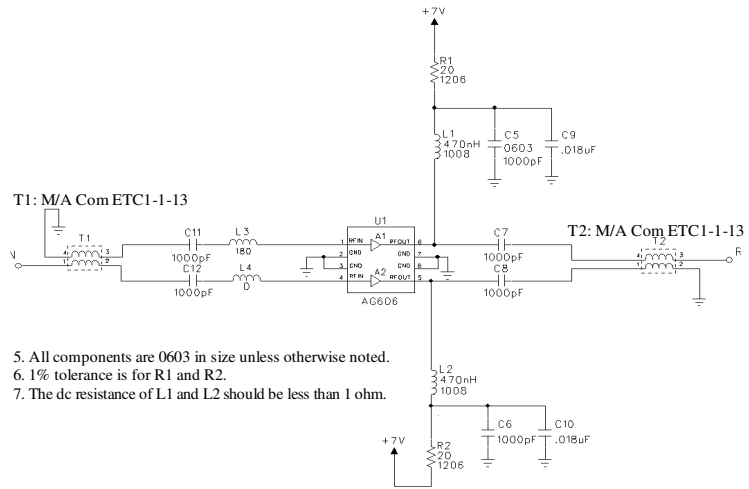

- All components are 0603 in size unless otherwise noted.
- 1% tolerance is for R1 and R2.
- The dc resistance of L1 and L2 should be less than 1 ohm.

### Recommended Bias Resistor Values

| Supply Voltage | R1/R2 Value | Size    |
|----------------|-------------|---------|
| 7 V            | 20.5 ohms   | 1206    |
| 8 V            | 32.5 ohms   | 1210    |
| 9 V            | 44.5 ohms   | 2010    |
| 10 V           | 56.5 ohms   | 2010    |
| 12 V           | 81 ohms     | 2010    |
| 24 V           | 227 ohms    | 2 Watts |

## 75 Ω Push-Pull Application Circuit Performance (Vsupply = +7 V, Rbias = 20.5 Ω, 25 °C)

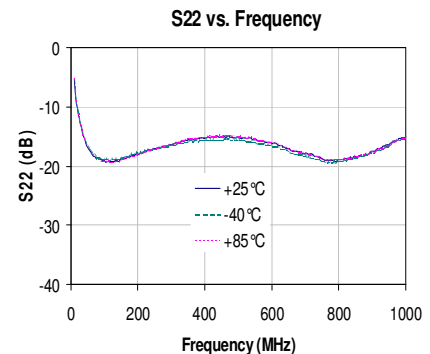
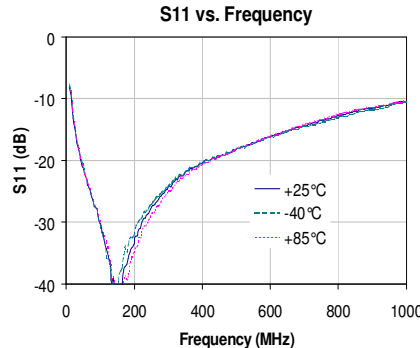
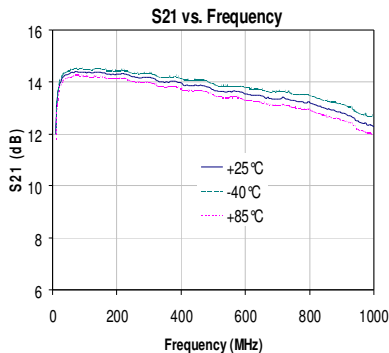

## 75 $\Omega$ Push-Pull Application Circuit Performance (Cont'd)

(V<sub>supply</sub>=7V, R<sub>bias</sub>= 20.5  $\Omega$ , 25 °C)

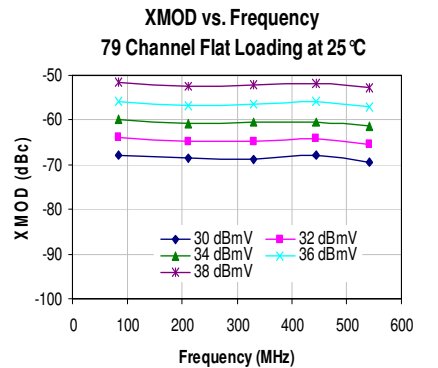
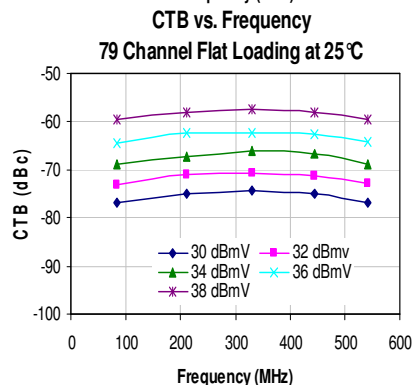
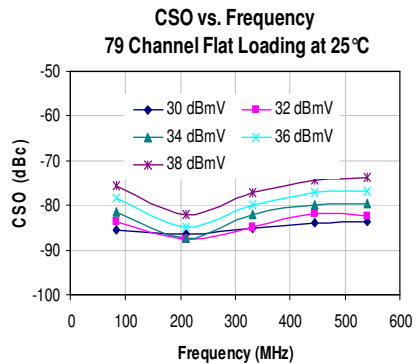
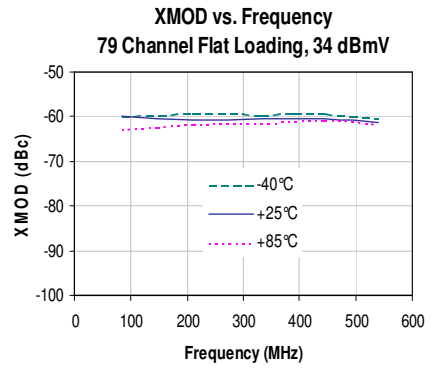
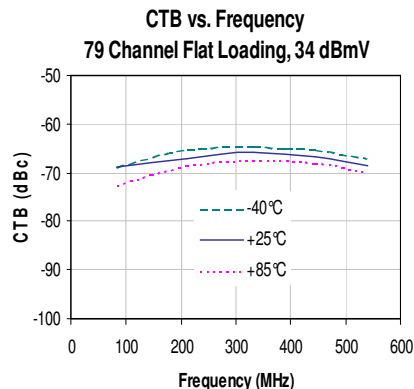
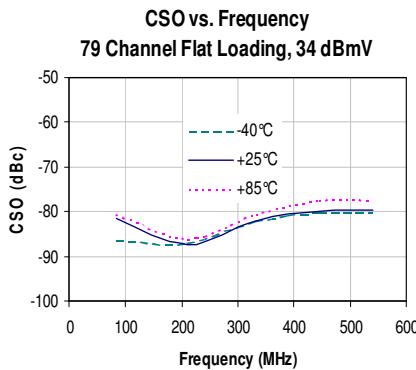
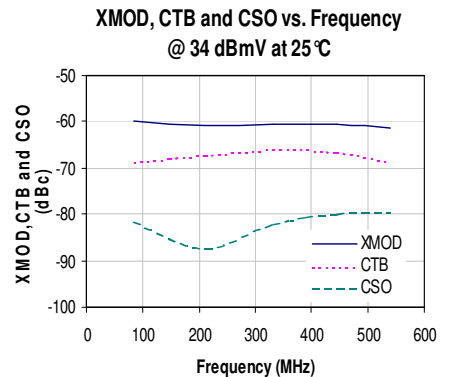
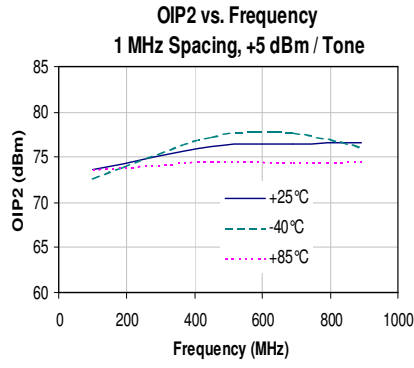
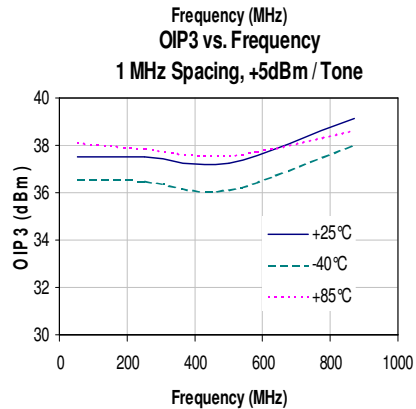
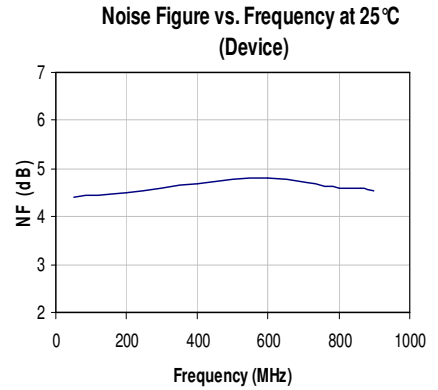
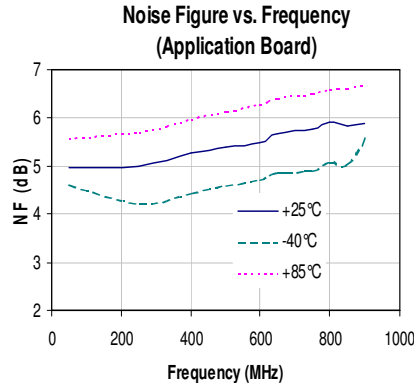
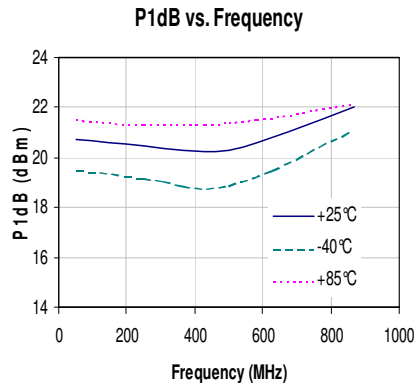

## AG606-G (Lead-Free Package) Mechanical Information

This package is lead-free /green/ RoHS-compliant. The plating material on the leads is NiPdAu. It is compatible with both lead-free (maximum 260 °C reflow temperature) and lead (maximum 245 °C reflow temperature) soldering processes.

### Outline Drawing

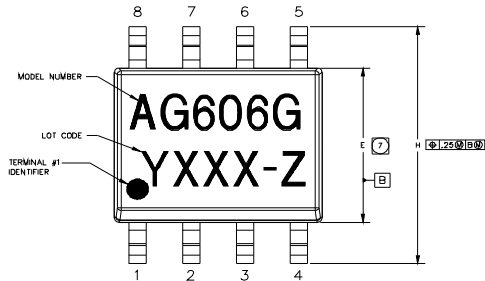

- NOTES:
- EXCEPT WHERE NOTED, THIS PART OUTLINE CONFORMS TO JEDEC STANDARD MS-012, ISSUE C FOR SMALL OUTLINE (SMD) PERIPHERAL TERMINALS 5.25mm BODY WIDTH (PLASTIC).
  - DIMENSIONING & TOLERANCING CONFORM TO ANSI Y14.4M-1994.
  - ALL DIMENSIONS ARE IN MILLIMETERS (INCHES). ANGLES ARE IN DEGREES.
  - DOES NOT INCLUDE MOLD FLASH, PROTRUSIONS OR GATE BURRS, WHICH SHALL NOT EXCEED .15mm(.006in) PER SIDE.
  - DEVIATION FROM JEDEC MS-012 STANDARD.
  - LENGTH OF TERMINAL FOR SOLDERING TO A SUBSTRATE.
  - DOES NOT INCLUDE INTER-LEAD FLASH OR PROTRUSIONS, WHICH SHALL NOT EXCEED .25mm(.010in) PER SIDE.

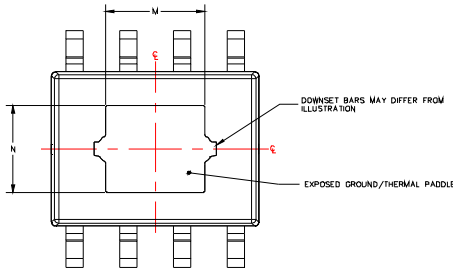
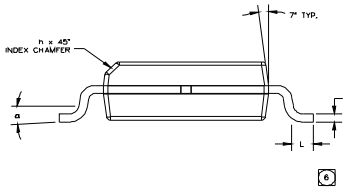
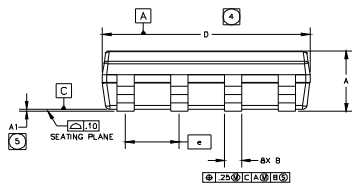

| SYMBOL | MILLIMETERS |      |      | INCHES   |      |      |
|--------|-------------|------|------|----------|------|------|
|        | MIN         | NOM  | MAX  | MIN      | NOM  | MAX  |
| A      | 1.42        | 1.52 | 1.62 | .056     | .060 | .064 |
| A1     | 0           | .05  | 10   | 0        | .002 | .004 |
| B      | .38         | .41  | .43  | .015     | .016 | .017 |
| C      | .19         | .20  | .25  | .007     | .008 | .010 |
| D      | 4.80        | 4.90 | 5.00 | .189     | .193 | .197 |
| E      | 3.80        | 3.90 | 4.00 | .150     | .154 | .157 |
| e      | 1.27 BSC    |      |      | .050 BSC |      |      |
| H      | 5.80        | 6.0  | 6.20 | .228     | .236 | .244 |
| h      | .25         | .33  | .50  | .01      | .013 | .02  |
| L      | .40         | .84  | 1.27 | .016     | .033 | .050 |
| M      | 2.21        | 2.34 | 2.47 | .087     | .092 | .097 |
| N      | 2.08        | 2.21 | 2.34 | .082     | .087 | .092 |
| e      | 0           | 4"   | 8"   | 0        | 4"   | 8"   |

### Land Pattern

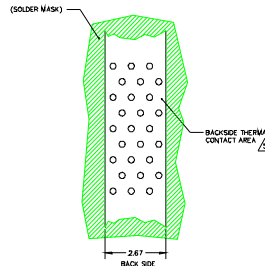
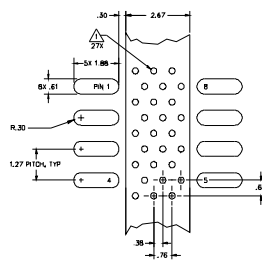
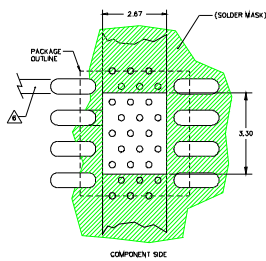

### Product Marking

The AG606 will be marked with an "AG606G" designator with a lot code marked below the part designator. The "Y" represents the last digit of the year the part was manufactured, the "XXX" is an auto-generated number, and "Z" refers to a wafer number in a lot batch.

Tape and reel specifications for this part are located on the website in the "Application Notes" section.

### ESD / MSL Information

ESD Rating: Class 1C  
 Value: 1000 to 2000 V  
 Test: Human Body Model (HBM)  
 Standard: JEDEC Standard JESD22-A114

ESD Rating: Class IV  
 Value: Passes greater than 1000 V  
 Test: Charge Device Model (CDM)  
 Standard: JEDEC Standard JESD22-C101

MSL Rating: Level 2 at +260 °C convection reflow  
 Standard: JEDEC Standard J-STD-020A

### Mounting Config. Notes

- Ground / thermal vias are critical for the proper performance of this device. Vias should use a .35mm (#80/.0135") diameter drill and have a final plated through diameter of .25mm (.010")
- Add as much copper as possible to inner and outer layers near the part to ensure optimal thermal performance.
- To ensure reliable operation, device ground paddle-to-ground pad solder joint is critical.
- Add mounting screws near the part to fasten the board to a heatsink. Ensure that the ground / thermal via region contacts the heatsink.
- For optimal thermal performance, expose soldermask on backside where it contacts the heatsink.
- RF trace width depends upon the PC board material and construction.
- Use 1 oz. Copper minimum.
- If the PCB design rules allow, ground vias should be placed under the land pattern for better RF and thermal performance. Otherwise ground vias should be placed as close to the land pattern as possible.
- All dimensions are in mm. Angles are in degrees.



Компания «ЭлектроПласт» предлагает заключение долгосрочных отношений при поставках импортных электронных компонентов на взаимовыгодных условиях!

Наши преимущества:

- Оперативные поставки широкого спектра электронных компонентов отечественного и импортного производства напрямую от производителей и с крупнейших мировых складов;
- Поставка более 17-ти миллионов наименований электронных компонентов;
- Поставка сложных, дефицитных, либо снятых с производства позиций;
- Оперативные сроки поставки под заказ (от 5 рабочих дней);
- Экспресс доставка в любую точку России;
- Техническая поддержка проекта, помощь в подборе аналогов, поставка прототипов;
- Система менеджмента качества сертифицирована по Международному стандарту ISO 9001;
- Лицензия ФСБ на осуществление работ с использованием сведений, составляющих государственную тайну;
- Поставка специализированных компонентов (Xilinx, Altera, Analog Devices, Intersil, Interpoint, Microsemi, Aeroflex, Peregrine, Syfer, Eurofarad, Texas Instrument, Miteq, Cobham, E2V, MA-COM, Hittite, Mini-Circuits, General Dynamics и др.);

Помимо этого, одним из направлений компании «ЭлектроПласт» является направление «Источники питания». Мы предлагаем Вам помощь Конструкторского отдела:

- Подбор оптимального решения, техническое обоснование при выборе компонента;
- Подбор аналогов;
- Консультации по применению компонента;
- Поставка образцов и прототипов;
- Техническая поддержка проекта;
- Защита от снятия компонента с производства.



#### Как с нами связаться

**Телефон:** 8 (812) 309 58 32 (многоканальный)

**Факс:** 8 (812) 320-02-42

**Электронная почта:** [org@eplast1.ru](mailto:org@eplast1.ru)

**Адрес:** 198099, г. Санкт-Петербург, ул. Калинина, дом 2, корпус 4, литера А.