

THIS DRAWING IS UNPUBLISHED.

RELEASED FOR PUBLICATION

© COPYRIGHT - By -

ALL RIGHTS RESERVED.

LOC	DIST	REVISIONS					
GP	00	P	LTR	DESCRIPTION	DATE	DWN	APVD
		H1		ECR-11-025464	16DEC11	RK	BVH

NOTES:

- △ PITCH TOLERANCE TO BE ±.18[.007] FOR 1.27[.050] PITCH JUMPERS & ±.25[.010] FOR ALL REMAINING PITCHES. TOLERANCE TO BE NON CUMULATIVE OVER GAUGE LENGTH.
- △ 11.92-152.40[.500-6.000] ARE STANDARD LENGTHS. JUMPERS ARE AVAILABLE IN INCREMENTS OF 2.50[.10] PLUS 6.35[.25] AND 19.05[.75].
- △ DELETED
- △ FOR CONDUCTOR PITCH 7 (2mm), ON PAGE 2 & 3, DIMENSION "B" IS 2.00[.079]
- △ SPECIAL PIN LENGTHS ARE AVAILABLE FOR JUMPERS WITH A PIN CONFIGURATION OF "A" OR "B" ON LENGTHS OF UP TO 609.6[24.0] IN 2.54[.100] & 5.08[.200] PITCH VARIANTS ONLY BY ADDING THE FOLLOWING SUFFIXES:

SUFFIX	PEN LENGTH	TOLERANCE
V1	2.85 (.112)	±.305 [±.012]
V2	3.40 (.134)	
V3	4.10 (.161)	
V4	6.50 (.256)	
V5	3.10 (.122)	
V6	2.81 (.150)	
V7	4.50 (.177)	
V8	2.00 (.079)	
V9	TBD	
V10	.76 (.030)	
V11	2.41 (.095)	

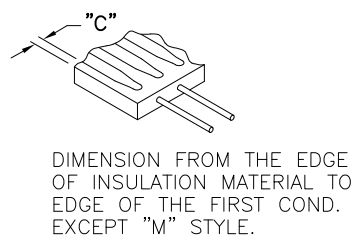

6. RECOMMENDED PCB HOLE DRILLING DETAILS ARE AS FOLLOWS:-

PITCH A	ØG
1.27 (.050)	.70 (.028)
1.90 (.075)	.80 (.031)
2.54 (.100)	.95 (.037)
3.18 (.125)	.95 (.037)
3.81 (.150)	.95 (.037)
5.08 (.200)	.95 (.037)

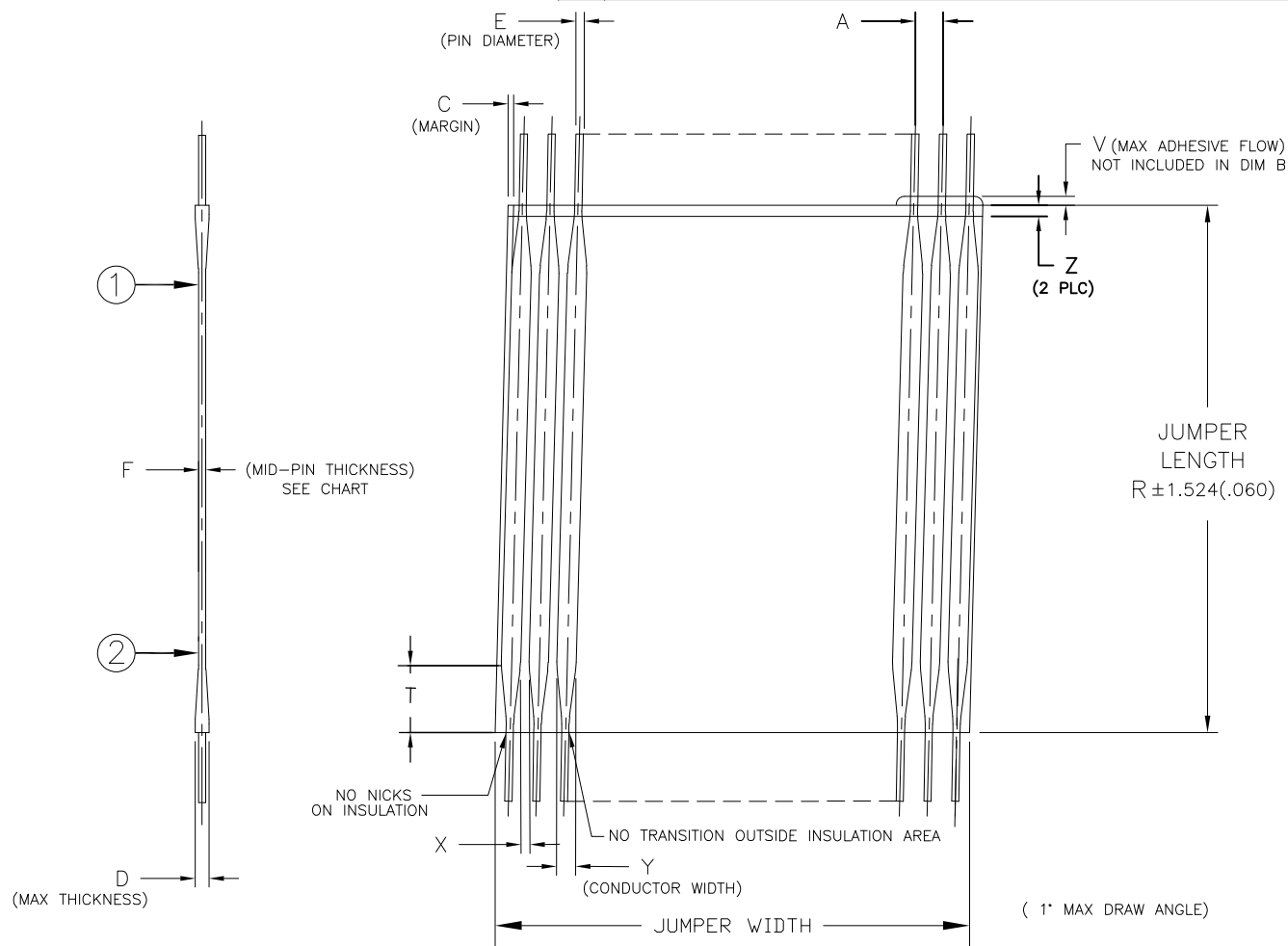
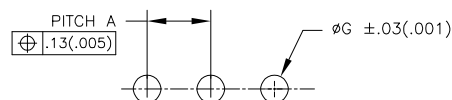

JUMPER LENGTH	PITCH (NOMINAL)	TRANSITION MAX	MAX/MIN MARGIN	△ PIN DIAMETER	WIRE GAUGE (AWG)	MIN/MAX No OF CONDUCTORS	MAXIMUM ADHESIVE FLOW	MIN GAP BETWEEN CONDUCTORS	CONDUCTOR WIDTH	MAXIMUM INSULATION MISMATCH	MAX THICKNESS
R △	A △	T	C	E	-	-	V	X	Y	Z	D
11.93 (.50) TO 863.6 (30.00) IN STEPS OF 2.50 (.10) PLUS 6.35 (.25) AND 19.05 (.75)	1.00 (0.039)	4.32 [.170]	0.35 (0.014) 0.17 (.007)	0.330 (.0130) 0.317 (.0125)	28	2-70	0.38 (0.015)	0.13 (0.009)	0.76 (.030) 0.56 (.022)	.76 (.030)	.64
	1.25 (0.049)	4.32 [.170]	0.50 (0.020) 0.17 (0.007)	0.330 (.0130) 0.317 (.0125)	28	2-70	0.38 (0.015)	0.25 (0.010)	0.89 (.035) 0.64 (.025)	.76 (.030)	.64
	1.27 (0.050)	4.32 [.170]	0.50 (0.020) 0.17 (0.007)	0.330 (.0130) 0.317 (.0125)	28	2-70	0.38 (0.015)	0.25 (0.010)	0.89 (.035) 0.64 (.025)	.76 (.030)	.64
	2.00 (0.079)	5.08 [.200]	0.70 (0.028) 0.25 (0.010)	0.416 (0.0164) 0.400 (0.0157)	26	2-50	0.38 (0.015)	0.38 (0.015)	1.14 (.045) 0.89 (.035)	.76 (.030)	.84
	1.90 (0.075)	5.08 [.200]	0.70 (0.028) 0.25 (0.010)	0.416 (0.0164) 0.400 (0.0157)	26	2-50	0.38 (0.015)	0.38 (0.015)	1.14 (.045) 0.89 (.035)	.76 (.030)	.84
	2.54 (0.100)	6.35 [.250]	0.80 (0.031) 0.25 (0.010)	0.526 (0.0207) 0.505 (0.0199)	24	2-50	0.51 (0.020)	0.51 (0.020)	1.52 (.060) 1.27 (.050)	.76 (.030)	.84
	3.18 (0.125)	6.35 [.250]	1.00 (0.039) 0.25 (0.010)	0.526 (0.0207) 0.505 (0.0199)	24	2-25	0.51 (0.020)	0.51 (0.020)	1.52 (.060) 1.27 (.050)	.76 (.030)	.84
	3.81 (0.150)	6.35 [.250]	1.00 (0.039) 0.25 (0.010)	0.526 (0.0207) 0.505 (0.0199)	24	2-20	0.51 (0.020)	0.51 (0.020)	1.52 (.060) 1.27 (.050)	.76 (.030)	.84
	5.08 (0.200)	6.35 [.250]	1.00 (0.039) 0.25 (0.010)	0.526 (0.0207) 0.505 (0.0199)	24	2-15	0.51 (0.020)	0.51 (0.020)	1.52 (.060) 1.27 (.050)	.76 (.030)	.84

- △ BEND RADIUS TO APPLY ONLY IN THE FLAT SECTION OF JUMPER BETWEEN THE CONDUCTOR TRANSITION AREAS.
- △ PER 108-2135.
- 9. TOOL MARKS PERMISSIBLE ON BENDS. NO EXPOSED COPPER.
- △ PIN DIAMETER SPECIFIED NOT APPLICABLE IN BENDING AREA OF PIN, DUE TO NORMAL DEFORMATION OF BENDING PROCESS.
- △ REFER TO RELEVANT MATERIAL SPECIFICATIONS.

F - MID POINT THICKNESS BETWEEN PT 1 & PT 2	MINIMUM	MAXIMUM
	NOMEX®	.152 [.006]
POLYESTER	.152 [.006]	.305 [.012]
KAPTON®	.102 [.004]	.254 [.010]
TEFLON®	.305 [.012]	.533 [.021]

12. PRODUCT AND PROCESSING MUST MEET REQUIREMENTS OF TE CONNECTIVITY STANDARD 230-702.

Nomex®, Teflon® and Kapton® are trademarks of E. I. DuPont de Nemours.

THIS DRAWING IS A CONTROLLED DOCUMENT.

DWN J. SCHWARTZ 28FEB01
CHK E. FOX 28FEB01
APVD E. FOX 28FEB01

NAME: FLEXSTRIP PIN CONFIGURATIONS, GENERIC

SIZE: A3 CAGE CODE: 00779 DRAWING NO: C-1474339 RESTRICTED TO: -

SCALE: N.T.S. SHEET: 1 OF 4 REV: H1

CUSTOMER DRAWING

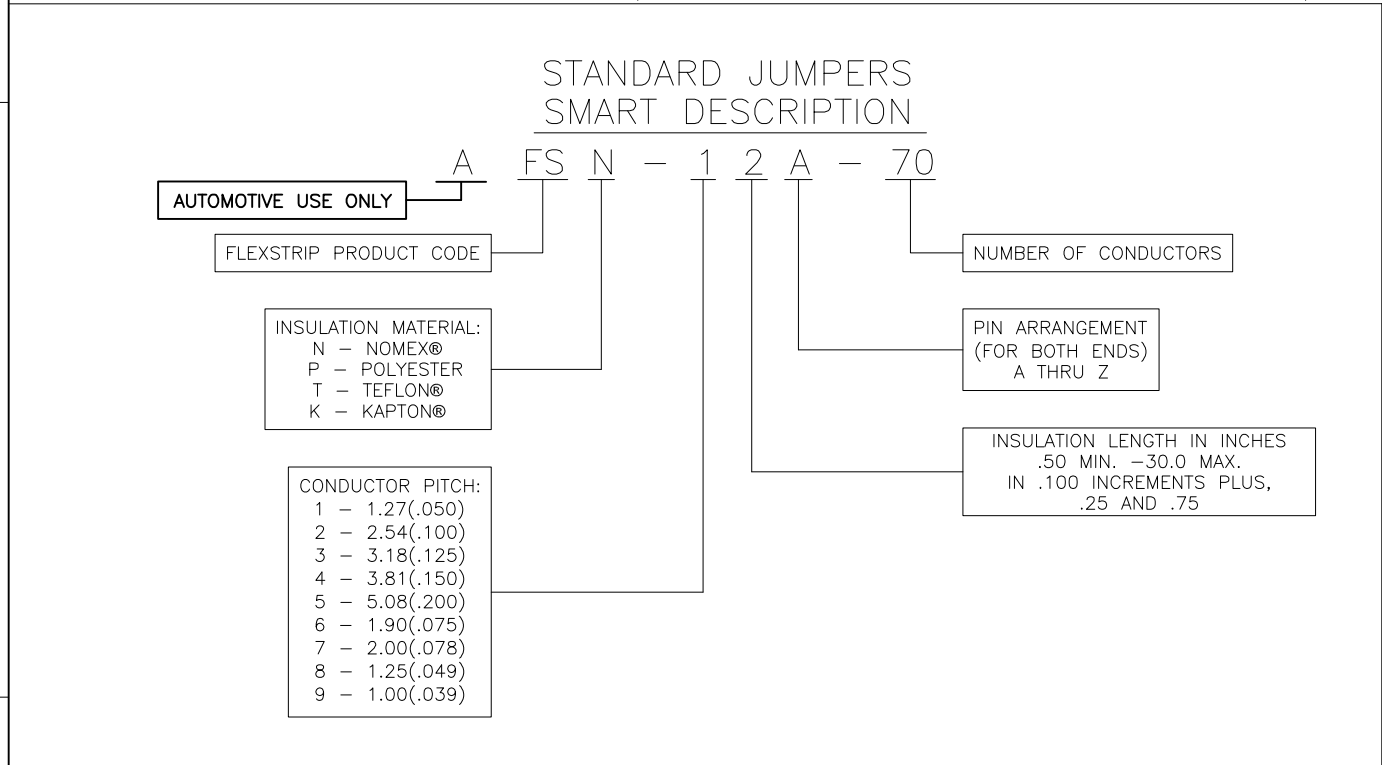

MANUFACTURING NOTE:

MINIMUM GAP BETWEEN STRIPS

SK/A/Z	.75 INCH
LP	1.1 INCH

MINIMUM CONDUCTOR COUNT PER STRIP FOR LINE JOBS

PITCH	CONDUCTOR
1 1.27 (.050)	60
2 2.54 (.100)	60
3 3.18 (.125)	60
4 3.81 (.150)	50
5 5.08 (.200)	40
6 1.91 (.075)	60
7 2.0 (.078)	60
8 1.24 (.049)	60
9 1.0 (.039)	80

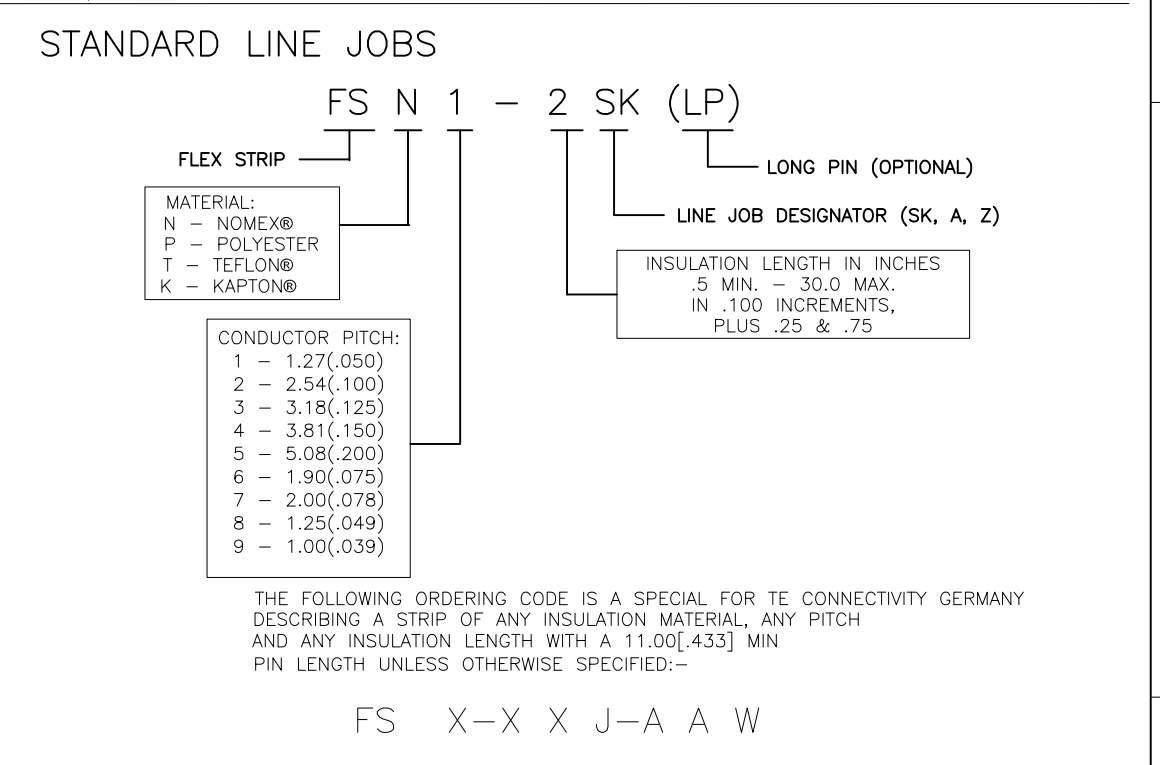

Nomex®, Teflon® and Kapton® are trademarks of E. I. DuPont de Nemours.

THIS DRAWING IS A CONTROLLED DOCUMENT.

DIMENSIONS: MM [INCHES]	TOLERANCES UNLESS OTHERWISE SPECIFIED:
0 PLC	± -
1 PLC	± -
2 PLC	± -
3 PLC	± -
4 PLC	± -
ANGLES	± 1/2°
MATERIAL	FINISH

DWN J. SCHWARTZ	28FEB01	 TE Connectivity	NAME	FLEXSTRIP PIN CONFIGURATIONS, GENERIC	
CHK E. FOX	28FEB01				
APVD E. FOX	28FEB01				
PRODUCT SPEC					
APPLICATION SPEC		SIZE	CAGE CODE	DRAWING NO	RESTRICTED TO
WEIGHT	-	A3	00779	C-1474339	-
CUSTOMER DRAWING		SCALE	N.T.S.	SHEET	2 OF 4
				REV	H1

THIS DRAWING IS UNPUBLISHED. RELEASED FOR PUBLICATION
 © COPYRIGHT - By - ALL RIGHTS RESERVED.

LOC	DIST	REVISIONS					
GP	00	P	LTR	DESCRIPTION	DATE	DWN	APVD
		-		SEE SHEET 1	-	-	-

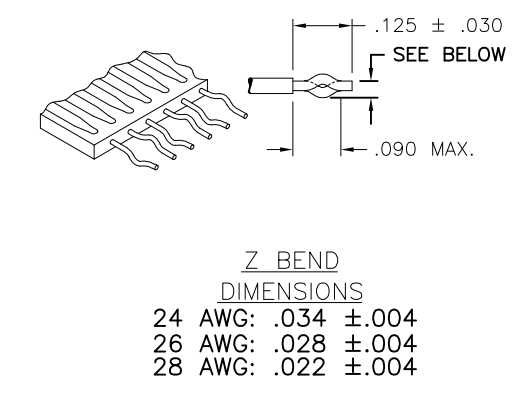

**SPECIAL JUMPERS
SMART DESCRIPTION**

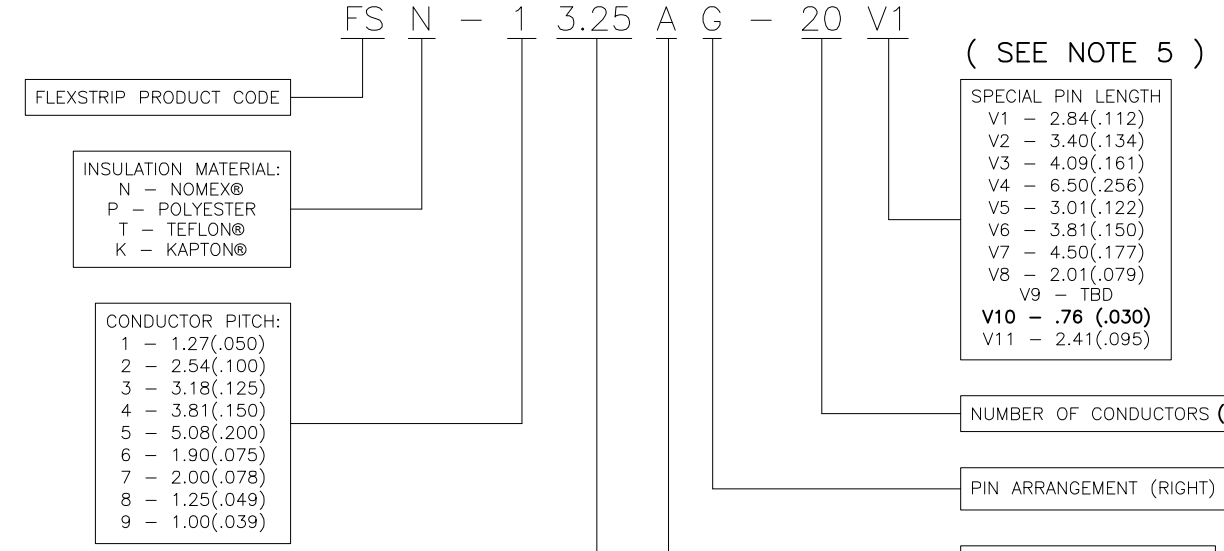

CONDUCTOR PITCH	BENDS AVAILABLE
1 - 1.27/(.050)	E,F,G,H,J,K,L
2 - 2.54/(.100)	E,F,G,H,J,K,L
3 - 3.18/(.125)	E
4 - 3.81/(.150)	E
5 - 5.08/(.200)	E
6 - 1.91/(.075)	E,F,G,H,J,K,L
7 - 2.00/(.0787)	E,F,G,H,J,K,L
8 - 1.25/(.049)	E
9 - 1.00/(.039)	E

E THRU L BEND
"A" DIM
3.18±0.76/(.125±.030)
"B" DIM
2.54±0.25/(.100±.010)

SPECIAL FLEXSTRIP BENDS
 SPECIAL FLEXSTRIP BENDS
 E THRU R, AND Z MAY APPLY TO EITHER
 LEFT OF RIGHT SIDE

Nomex®, Teflon® and Kapton® are trademarks of E. I. DuPont de Nemours.

THIS DRAWING IS A CONTROLLED DOCUMENT.		DWN	J. SCHWARTZ	28FEB01	 TE Connectivity	NAME		FLEXSTRIP PIN CONFIGURATIONS, GENERIC			
DIMENSIONS: MM [INCHES]		CHK	E. FOX	28FEB01		PRODUCT SPEC		-			
		APVD	E. FOX	28FEB01		APPLICATION SPEC		-			
TOLERANCES UNLESS OTHERWISE SPECIFIED: 0 PLC ± - 1 PLC ± - 2 PLC ± - 3 PLC ± - 4 PLC ± - ANGLES ± 1/2'		MATERIAL		FINISH		SIZE		CAGE CODE	DRAWING NO		
MATERIAL		WEIGHT		-		A3		00779	C-1474339		
CUSTOMER DRAWING						SCALE	N.T.S.	SHEET	3 OF 4	REV	H1

THIS DRAWING IS UNPUBLISHED. RELEASED FOR PUBLICATION
 © COPYRIGHT - By - ALL RIGHTS RESERVED.

LOC GP	DIST 00	REVISIONS		
P	LTR	DESCRIPTION	DATE	DWN
	-	SEE SHEET 1	-	-

NORMAL CONDUCTOR PITCH		1.00 (.039)	1.25 (.049)	1.27 (.050)	1.90 (.075)	2.00 (.078)	2.54 (.100)	3.18 (.125)	3.81 (.150)	5.08 (.200)
WIRE GAUGE		AWG 28	AWG 28	AWG 28	AWG 26	AWG 26	AWG 24	AWG 24	AWG 24	AWG 24
NOMINAL WIRE DIAMETER		.32(.0126)	.32(.0126)	.32(.0126)	.40(.0159)	.40(.0159)	.51(.0201)	.51(.0201)	.51(.0201)	.51(.0201)
CURRENT RATING		8	8	8	8	8	8	8	8	8
VOLTAGE RATING		8	8	8	8	8	8	8	8	8
MAX NUMBER OF CONDUCTORS PER JUMPER		8	8	8	8	8	8	8	8	8
MIN BREAKDOWN VOLTAGE @ 1 MIN		8	8	8	8	8	8	8	8	8
INSULATION RESISTANCE (GND. SIG. GND) 305 (12") SAMPLE @ 500VDC	P N T K	8	8	8	8	8	8	8	8	8
CAPACITANCE (pf / 50.8 (12") LENGTH) (GND, SIG, GND) (AVERAGE)	P N T K	8	8	8	8	8	8	8	8	8
CHARACTERISTIC IMPEDANCE (GND. SIG. GND) (AVERAGE)	P N T K	8	8	8	8	8	8	8	8	8
APPLICATION TEMP RANGE (C°) (FOR SOLDERING)	P N T K	200 / 4 sec 200 / 4 sec 240 / 4 sec 240 / 4 sec	200 / 4 sec 200 / 4 sec 240 / 4 sec 240 / 4 sec	200 / 4 sec 200 / 4 sec 240 / 4 sec 240 / 4 sec	200 / 4 sec 200 / 4 sec 240 / 4 sec 240 / 4 sec	200 / 4 sec 200 / 4 sec 240 / 4 sec 240 / 4 sec	250 / 4 sec 250 / 4 sec 260 / 5 sec 260 / 5 sec	250 / 4 sec 250 / 4 sec 260 / 5 sec 260 / 5 sec	250 / 4 sec 250 / 4 sec 260 / 5 sec 260 / 5 sec	250 / 4 sec 250 / 4 sec 260 / 5 sec 260 / 5 sec
OPERATING TEMPERATURE (C°)	P N T K	-40 to 105 (For all Conductor Pitches) -40 to 125 (For all Conductor Pitches) -40 to 150 (For all Conductor Pitches) -40 to 150 (For all Conductor Pitches)								
MINIMUM BEND RADIUS	P N T K	3.18mm (For all Conductor Pitches) 3.18mm (For all Conductor Pitches) 3.18mm (For all Conductor Pitches) 3.18mm (For all Conductor Pitches)								
UL STYLE NUMBER	P N T K	2639 (For all Conductor Pitches .100 and above) 5456 (For all Conductor Pitches .100 and above) 2928 (For all Conductor Pitches .100 and above) 2927 (For all Conductor Pitches .100 and above)								

ABR.	MATERIAL	SPECIFICATION
	COPPER WIRE	100-1577
P	POLYESTER	100-1575
N	NOMEX®	100-1758
T	TEFLON®	100-1574
K	KAPTON®	100-1576

Nomex®, Teflon® and Kapton® are trademarks of E. I. DuPont de Nemours.

THIS DRAWING IS A CONTROLLED DOCUMENT.		DWN J. SCHWARTZ 28FEB01	 TE Connectivity				
DIMENSIONS: MM [INCHES]		CHK E. FOX 28FEB01					
TOLERANCES UNLESS OTHERWISE SPECIFIED:		APVD E. FOX 28FEB01	NAME FLEXSTRIP PIN CONFIGURATIONS, GENERIC				
0 PLC ± - 1 PLC ± - 2 PLC ± - 3 PLC ± - 4 PLC ± - ANGLES ± 1/2°		PRODUCT SPEC -	-				
MATERIAL		APPLICATION SPEC -	SIZE A3	CAGE CODE 00779	DRAWING NO C-1474339	RESTRICTED TO -	
		WEIGHT -	CUSTOMER DRAWING		SCALE N.T.S.	SHEET 4 OF 4	REV H1



Компания «ЭлектроПласт» предлагает заключение долгосрочных отношений при поставках импортных электронных компонентов на взаимовыгодных условиях!

Наши преимущества:

- Оперативные поставки широкого спектра электронных компонентов отечественного и импортного производства напрямую от производителей и с крупнейших мировых складов;
- Поставка более 17-ти миллионов наименований электронных компонентов;
- Поставка сложных, дефицитных, либо снятых с производства позиций;
- Оперативные сроки поставки под заказ (от 5 рабочих дней);
- Экспресс доставка в любую точку России;
- Техническая поддержка проекта, помощь в подборе аналогов, поставка прототипов;
- Система менеджмента качества сертифицирована по Международному стандарту ISO 9001;
- Лицензия ФСБ на осуществление работ с использованием сведений, составляющих государственную тайну;
- Поставка специализированных компонентов (Xilinx, Altera, Analog Devices, Intersil, Interpoint, Microsemi, Aeroflex, Peregrine, Syfer, Eurofarad, Texas Instrument, Miteq, Cobham, E2V, MA-COM, Hittite, Mini-Circuits, General Dynamics и др.);

Помимо этого, одним из направлений компании «ЭлектроПласт» является направление «Источники питания». Мы предлагаем Вам помощь Конструкторского отдела:

- Подбор оптимального решения, техническое обоснование при выборе компонента;
- Подбор аналогов;
- Консультации по применению компонента;
- Поставка образцов и прототипов;
- Техническая поддержка проекта;
- Защита от снятия компонента с производства.



Как с нами связаться

Телефон: 8 (812) 309 58 32 (многоканальный)

Факс: 8 (812) 320-02-42

Электронная почта: org@eplast1.ru

Адрес: 198099, г. Санкт-Петербург, ул. Калинина, дом 2, корпус 4, литера А.