



Filters for Communication Lines

ISDN Systems

Series/Type: **B84312**

Date: January 2004

© EPCOS AG 2015. Reproduction, publication and dissemination of this publication, enclosures hereto and the information contained therein without EPCOS' prior express consent is prohibited.

EPCOS AG is a TDK Group Company.

**For ISDN-Interfaces S_0 , S_2 , U_{P0}
and U_2 plus Siemens Hicom installations
Stopband attenuation up to 40 GHz**



Features

- Use of coaxial feed-through capacitors on input and output
- Single or current-balanced chokes depending on requirement
- Insertion loss to CISPR 17

Installation

Single filters are attached straight to the shielding wall. Larger numbers can be housed in filter cabinets or boxes. Various models and the matching flexible connector fittings are available.

Overview of ISDN systems and suitable filters

System	Standard	Number of pairs	Transmission rate	Focal frequency f_{test}	Filter band width ($5 \times f_{\text{test}}$)	Z_L Ω	Filter (Ordering code)
S_2 and/or PCM 30	CCITT, G.703	2	2.048 Mbit/s	1.024 MHz	5.12 MHz	120	B84312C0112E001
S_0 ISDN, 2B+D	CCITT, I.430 ETS300012	2	144 kbit/s	96 kHz	480 kHz	85... 160	B84312C0110E001
U_{P0} ISDN, 2B+D	ZVEI	1	304 kbit/s (152 kbit/s in each direction)	192 kHz	960 kHz	100	B84312C0114B001
U_{2B1Q} ISDN, 2B+D	ANSI T1.601-1988	1	160 kbit/s	40 kHz	200 kHz	135	B84312C0060B001
U_{K0} ISDN, 2B+D	FTZ 1 TR 220	1	160 kbit/s	60 kHz	300 kHz	150	B84312C0060B001
U_{200} 1B+D	Interface for Siemens Hicom	1	160 kbit/s (80 kbit/s in each direction)	128 kHz	640 kHz	130	B84312C0114B001

ISDN systems
General technical data

Rated voltage	$V_{R,AC}$	42 and 100	V	
Rated voltage	$V_{R,DC}$	80 and 100	V	
Rated frequency	f_R	See characteristics		Pass bandwidth at Z_L
Rated current	I_R	100	mA	Referred to +40 °C ambient temperature
Line impedance	Z_L	See characteristics		
Test voltage	V_{rest}	250 VDC, 2 s 250 VDC, 2 s		Line/line Line/case
Maximum DC resistance	R_{max}	See characteristics		Per line
Permissible ambient temperature	T_A	-25/+40	°C	
Climatic category (EN 60068-1)		25/085/56		-25 °C/+85 °C/56 days damp heat test
Approx. weight		560	g	

Characteristics and ordering codes

$V_{R,AC}$	$V_{R,DC}$	f_R	Z_L	R_{max}	Number of pairs	Ordering code
V	V	MHz	Ω	Ω		
100	100	0 ... 0.3	150	2	1	B84312C0060B001
42	80	0 ... 4	100	4.2	1	B84312C0114B001
42	80	0 ... 4	100	4.2	2	B84312C0110E001
42	80	0 ... 10	50	1	2	B84312C0112E001

Insertion loss α_e in passband (typical)

B84312C0060B001

Measurement circuit

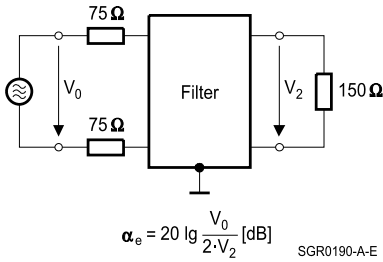

Symmetrical measurement circuit
with $Z_L = 150 \Omega$

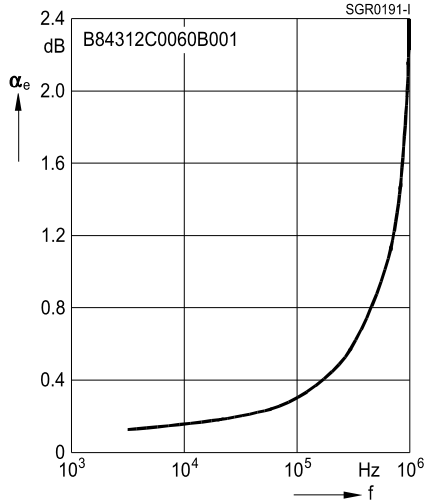

B84312C0110E001, ...C0114B001

Measurement circuit

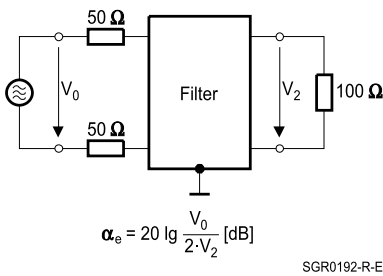

Symmetrical measurement circuit
with $Z_L = 100 \Omega$

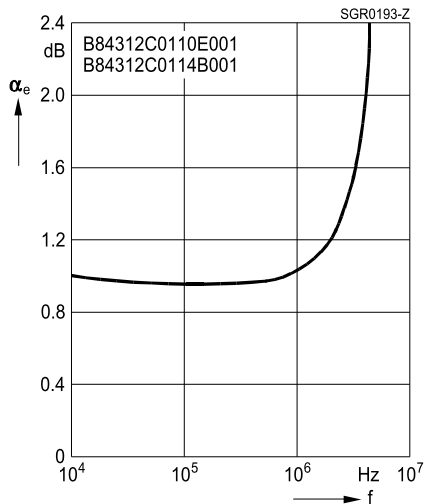

B84312C0112E001

Measurement circuit

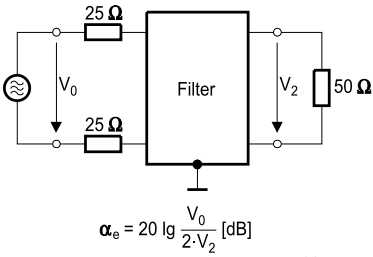

Symmetrical measurement circuit
with $Z_L = 50 \Omega$

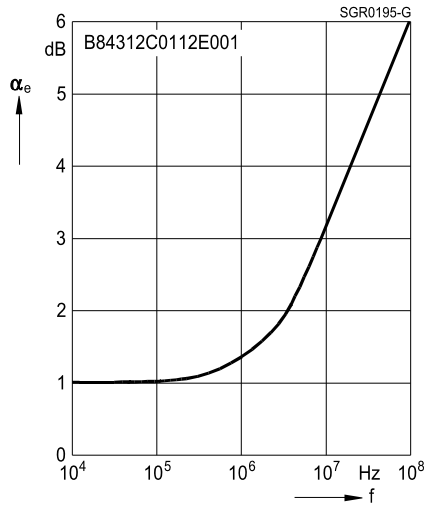

Insertion loss α_e in stopband (typical)

Measurement circuit

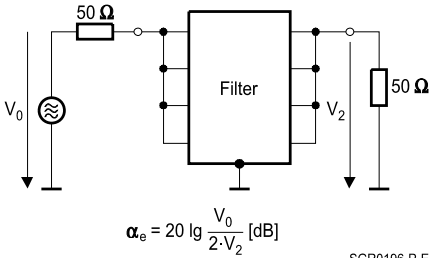

Asymmetrical measurement circuit
to MIL-STD-220A

B84312C0060B001

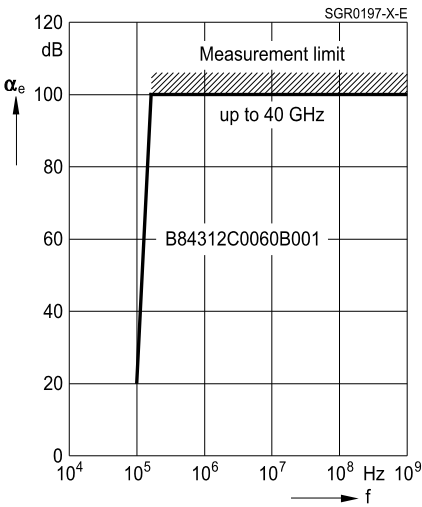

B84312C0110E001, ...C0114B001

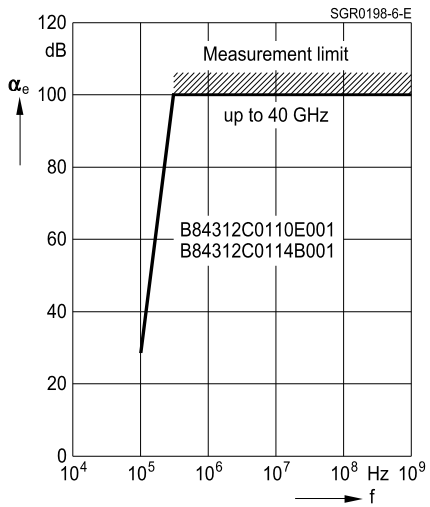

B84312C0112E001

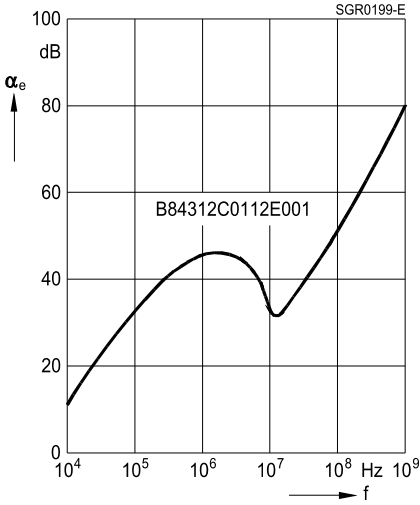

Signal characteristic to CCITT G.703
for filter B84312C0112E001

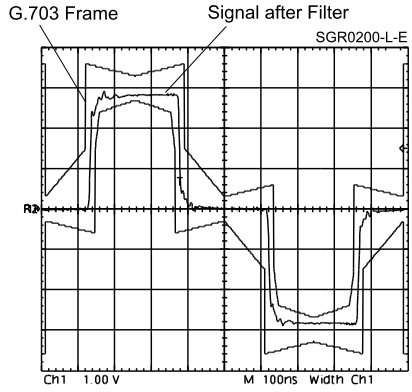

Dimensional drawing

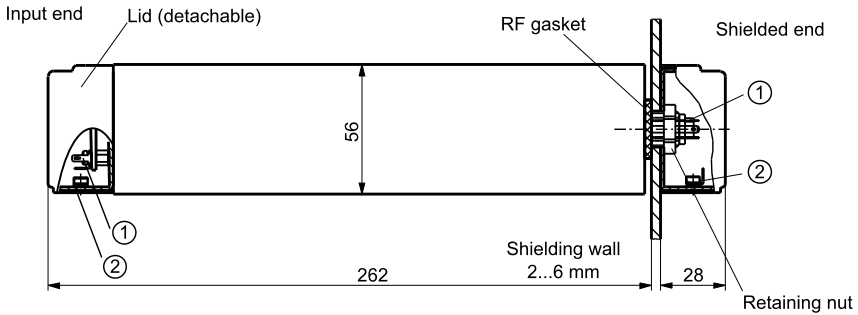

Plan view

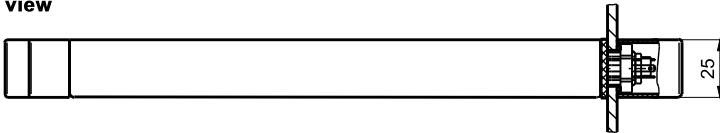

SGR0201-U-E

- ① Line connection at both ends:
2 x tab connectors for receptacle 2.8 x 0.5 (in accessory bag)
- ② Strain relief with ground connection for cable diameter 4.5 ... 6 mm

Hole for installation in shielding wall

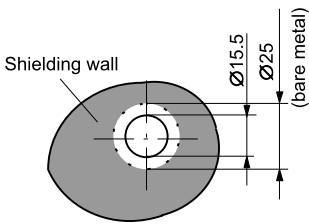

SGR0185-9-E

Important notes

The following applies to all products named in this publication:

1. Some parts of this publication contain **statements about the suitability of our products for certain areas of application**. These statements are based on our knowledge of typical requirements that are often placed on our products in the areas of application concerned. We nevertheless expressly point out **that such statements cannot be regarded as binding statements about the suitability of our products for a particular customer application**. As a rule we are either unfamiliar with individual customer applications or less familiar with them than the customers themselves. For these reasons, it is always ultimately incumbent on the customer to check and decide whether a product with the properties described in the product specification is suitable for use in a particular customer application.
2. We also point out that **in individual cases, a malfunction of electronic components or failure before the end of their usual service life cannot be completely ruled out in the current state of the art, even if they are operated as specified**. In customer applications requiring a very high level of operational safety and especially in customer applications in which the malfunction or failure of an electronic component could endanger human life or health (e.g. in accident prevention or life-saving systems), it must therefore be ensured by means of suitable design of the customer application or other action taken by the customer (e.g. installation of protective circuitry or redundancy) that no injury or damage is sustained by third parties in the event of malfunction or failure of an electronic component.
3. **The warnings, cautions and product-specific notes must be observed.**
4. In order to satisfy certain technical requirements, **some of the products described in this publication may contain substances subject to restrictions in certain jurisdictions (e.g. because they are classed as hazardous)**. Useful information on this will be found in our Material Data Sheets on the Internet (www.tdk-electronics.tdk.com/material). Should you have any more detailed questions, please contact our sales offices.
5. We constantly strive to improve our products. Consequently, **the products described in this publication may change from time to time**. The same is true of the corresponding product specifications. Please check therefore to what extent product descriptions and specifications contained in this publication are still applicable before or when you place an order.

We also **reserve the right to discontinue production and delivery of products**. Consequently, we cannot guarantee that all products named in this publication will always be available. The aforementioned does not apply in the case of individual agreements deviating from the foregoing for customer-specific products.
6. Unless otherwise agreed in individual contracts, **all orders are subject to our General Terms and Conditions of Supply**.
7. **Our manufacturing sites serving the automotive business apply the IATF 16949 standard**. The IATF certifications confirm our compliance with requirements regarding the quality management system in the automotive industry. Referring to customer requirements and customer specific requirements ("CSR") TDK always has and will continue to have the policy of respecting individual agreements. Even if IATF 16949 may appear to support the acceptance of unilateral requirements, we hereby like to emphasize that **only requirements mutually agreed upon can and will be implemented in our Quality Management System**. For clarification purposes we like to point out that obligations from IATF 16949 shall only become legally binding if individually agreed upon.
8. The trade names EPCOS, CeraCharge, CeraDiode, CeraLink, CeraPad, CeraPlas, CSMP, CTVS, DeltaCap, DigiSiMic, ExoCore, FilterCap, FormFit, LeaXield, MiniBlue, MiniCell, MKD, MKK, MotorCap, PCC, PhaseCap, PhaseCube, PhaseMod, PhiCap, PowerHap, PQSine, PQvar, SIFERRIT, SIFI, SIKOREL, SilverCap, SIMDAD, SiMic, SIMID, SineFormer, SIOV, ThermoFuse, WindCap are **trademarks registered or pending** in Europe and in other countries. Further information will be found on the Internet at www.tdk-electronics.tdk.com/trademarks.

Mouser Electronics

Authorized Distributor

Click to View Pricing, Inventory, Delivery & Lifecycle Information:

[EPCOS / TDK:](#)

[B84312C112E1](#) [B84312C110E1](#) [B84312C114B1](#) [B84312C60B1](#)



Компания «ЭлектроПласт» предлагает заключение долгосрочных отношений при поставках импортных электронных компонентов на взаимовыгодных условиях!

Наши преимущества:

- Оперативные поставки широкого спектра электронных компонентов отечественного и импортного производства напрямую от производителей и с крупнейших мировых складов;
- Поставка более 17-ти миллионов наименований электронных компонентов;
- Поставка сложных, дефицитных, либо снятых с производства позиций;
- Оперативные сроки поставки под заказ (от 5 рабочих дней);
- Экспресс доставка в любую точку России;
- Техническая поддержка проекта, помощь в подборе аналогов, поставка прототипов;
- Система менеджмента качества сертифицирована по Международному стандарту ISO 9001;
- Лицензия ФСБ на осуществление работ с использованием сведений, составляющих государственную тайну;
- Поставка специализированных компонентов (Xilinx, Altera, Analog Devices, Intersil, Interpoint, Microsemi, Aeroflex, Peregrine, Syfer, Eurofarad, Texas Instrument, Miteq, Cobham, E2V, MA-COM, Hittite, Mini-Circuits, General Dynamics и др.);

Помимо этого, одним из направлений компании «ЭлектроПласт» является направление «Источники питания». Мы предлагаем Вам помощь Конструкторского отдела:

- Подбор оптимального решения, техническое обоснование при выборе компонента;
- Подбор аналогов;
- Консультации по применению компонента;
- Поставка образцов и прототипов;
- Техническая поддержка проекта;
- Защита от снятия компонента с производства.



Как с нами связаться

Телефон: 8 (812) 309 58 32 (многоканальный)

Факс: 8 (812) 320-02-42

Электронная почта: org@eplast1.ru

Адрес: 198099, г. Санкт-Петербург, ул. Калинина, дом 2, корпус 4, литера А.