

0.5A/1A PWM/VFM Step-down DC/DC Converter with Synchronous Rectifier

NO.EA-362-160510

OUTLINE

The RP509x is a low supply current CMOS-based PWM/VFM step-down DC/DC converter with synchronous rectifier featuring 0.5 A / 1 A output current⁽¹⁾. Internally, a single converter consists of a reference voltage unit, an error amplifier, a switching control circuit, a mode control circuit, a soft-start circuit, an under-voltage lockout (UVLO) circuit, a thermal shutdown circuit, and switching transistors. The RP509x is employing synchronous rectification for improving the efficiency of rectification by replacing diodes with built-in switching transistors. Using synchronous rectification not only increases circuit performance but also allows a design to reduce parts count. Output voltage controlling method is selectable between a forced PWM control type and a PWM/VFM auto-switching control type, and can be set by the MODE pin. Output voltage type is selectable between an internally fixed output voltage type and an externally adjustable output voltage type. Protection circuits in the RP509x is current limit circuit and thermal shutdown circuit. LX current limit value (Typ.) is selectable between 1.6 A and 1.0 A.

The RP509Z is available in WLCSP-6-P6 which achieves high-density mounting on boards. Using capacitor of 0402- / 1005-size (inch / mm) and inductor of 0603- /1608-size (inch / mm) as external parts help to save space for devices. The RP509N under development is available in SOT-23-6.

FEATURES

- Input Voltage Range (Maximum Rating)2.3 V to 5.5 V (6.5 V)
- Output Voltage Range (Fixed Output Voltage Type)0.6 V to 3.3 V - Settable in 0.1 V Step
(Adjustable Output Voltage Type)0.6 V to 5.5 V
- Output Voltage Accuracy (Fixed Output Voltage Type)±1.5% ($V_{SET}^{(2)} \geq 1.2 V$), ±18 mV ($V_{SET} < 1.2 V$)
- Feedback Voltage Accuracy
(Adjustable Output Voltage Type)±9 mV ($V_{FB} = 0.6 V$)
- Output Voltage/Feedback Voltage Temperature Coefficient... ±100 ppm/°C
- Selectable Oscillator FrequencyTyp. 6.0 MHz
- Oscillator Maximum DutyMin. 100%
- Built-in Driver ON Resistance ($V_{IN} = 3.6 V$).....Typ. Pch. 0.175 Ω , Nch. 0.155 Ω (RP509Z)
- Standby Current.....Typ. 0 μA
- UVLO Detector ThresholdTyp. 2.0 V
- Soft-start TimeTyp. 0.15 ms
- Inductor Current Limit Circuit.....Typ. 1.6 A / 1.0 A - Selectable Current Limit
- Package.....WLCSP-6-P6 (1.28 mm x 0.88 mm)
SOT-23-6 《under development》

⁽¹⁾ This is an approximate value. The output current is dependent on conditions and external components.

⁽²⁾ V_{SET} = Set Output Voltage

RP509x

NO.EA-362-160510

APPLICATION

- Power source for Portable communication equipment such as mobile/smart phone, digital camera, and Note-PC
- Power source for Li-ion battery-used equipment

SELECTION GUIDE

The set output voltage, the output voltage type, the auto-discharge function⁽¹⁾, and the LX current limit for the ICs are user-selectable options.

Selection Guide

| Product Name | Package | Quantity per Reel | Pb Free | Halogen Free |
|--|------------|-------------------|---------|--------------|
| RP509ZxxX\$-E2-F | WLCSP-6-P6 | 5,000 pcs | Yes | Yes |
| RP509NxxX\$-TR-FE 《under development》 | SOT-23-6 | 3,000 pcs | Yes | Yes |

xx: Designation of the set output voltage (V_{SET})

For Fixed Output Voltage Type: 0.6 V (06) to 3.3 V (33) in 0.1 V steps⁽²⁾

For Adjustable Output Voltage Type: 00 only

X: Designation of LX Current Limit

1) Typ. 1.6 A

2) Typ. 1.0 A

\$: Designation of Version

| Version | Output Voltage Type | Auto-discharge Function | Oscillator Frequency | V_{SET} |
|---------|---------------------|-------------------------|----------------------|----------------|
| A | Fixed | No | 6.0 MHz | 0.6 V to 3.3 V |
| B | | Yes | | |
| C | Adjustable | No | | 0.6 V to 5.5 V |
| D | | Yes | | |

⁽¹⁾ Auto-discharge function quickly lowers the output voltage to 0 V, when the chip enable signal is switched from the active mode to the standby mode, by releasing the electrical charge accumulated in the external capacitor.

⁽²⁾ 0.05 V step is also available as a custom code.

BLOCK DIAGRAM

RP509ZxxXA/B, RP509NxxXA/B **《under development》** (Fixed Output Voltage Type)

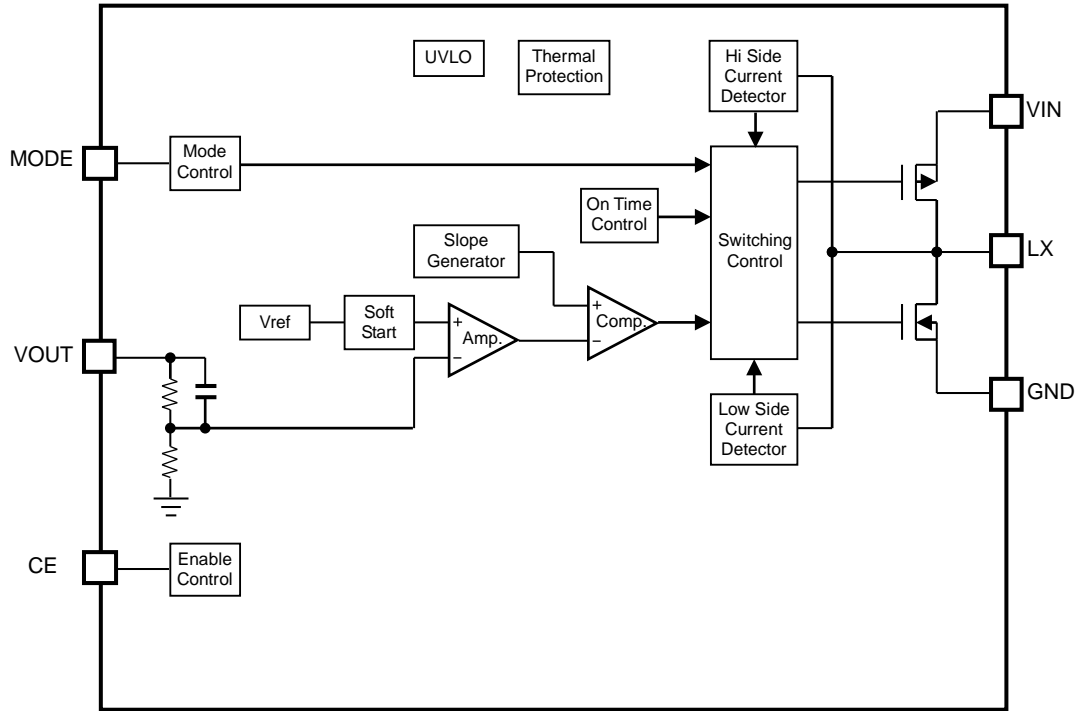

RP509xxxXA Block Diagram

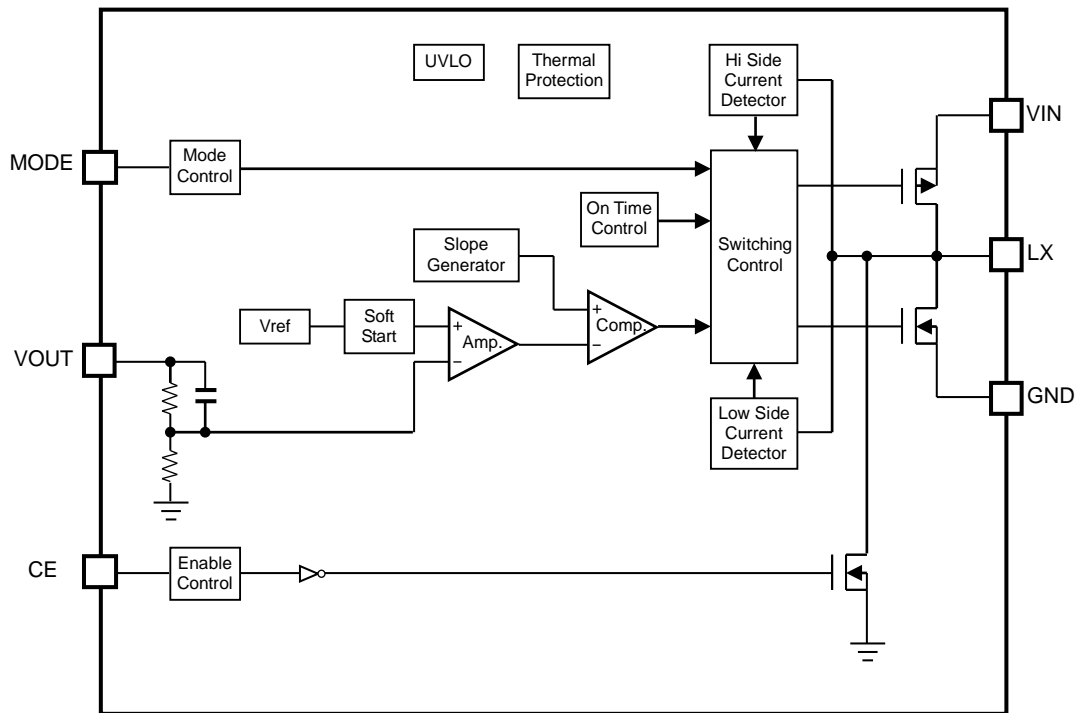

RP509xxxXB Block Diagram

RP509x

NO.EA-362-160510

RP509ZxxXC/D, RP509NxxXC/D *《under development》* (Adjustable Output Voltage Type)

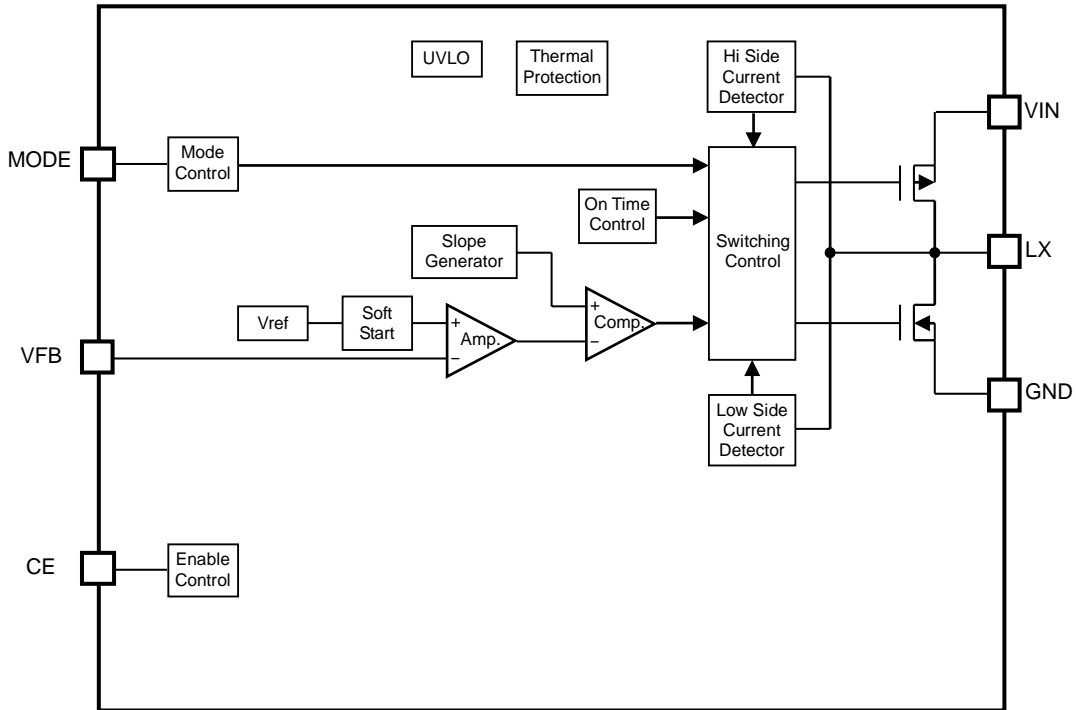

RP509x00XC Block Diagram

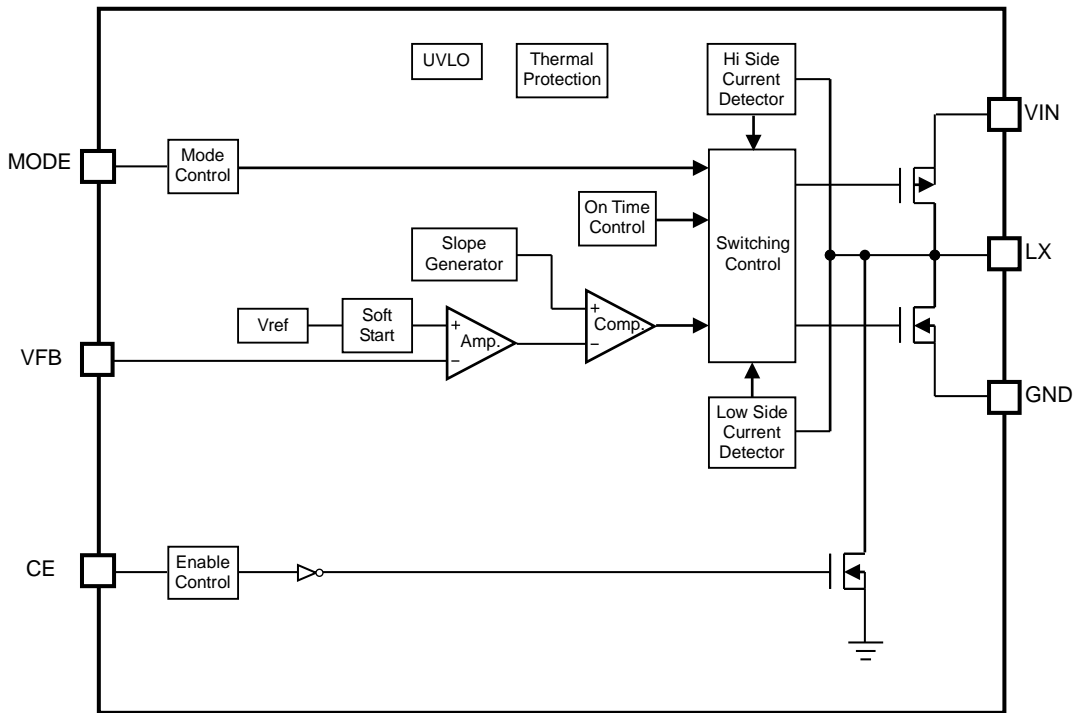

RP509x00XD Block Diagram

PIN DESCRIPTION

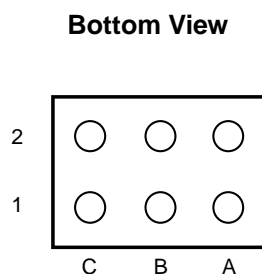
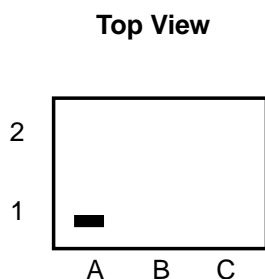

WLCSP-6 Pin Configurations

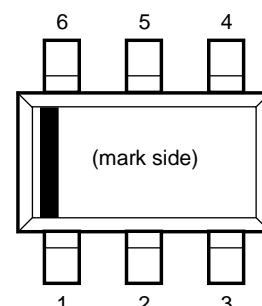

SOT-23-6 Pin Configurations

《under development》

WLCSP-6 Pin Description

| Pin No. | Symbol | Description |
|---------|-----------|--|
| A1 | MODE | Mode Control Pin ("H": forced PWM control, "L": PWM/VFM auto-switching control) |
| B1 | LX | Switching Pin |
| C1 | VOUT/ VFB | Output / Feedback Voltage Pin |
| A2 | VIN | Input Voltage Pin |
| B2 | CE | Chip Enable Pin (Active "H") |
| C2 | GND | Ground Pin |

SOT-23-6 Pin Description 《under development》

| Pin No. | Symbol | Description |
|---------|-----------|--|
| 1 | CE | Chip Enable Pin (Active "H") |
| 2 | GND | Ground Pin |
| 3 | VIN | Input Voltage Pin |
| 4 | MODE | Mode Control Pin ("H": forced PWM control, "L": PWM/VFM auto-switching control) |
| 5 | LX | Switching Pin |
| 6 | VOUT/ VFB | Output / Feedback Voltage Pin |

RP509x

NO.EA-362-160510

ABSOLUTE MAXIMUM RATINGS

Absolute Maximum Ratings

(GND = 0 V)

| Symbol | Item | Rating | Unit | |
|------------------|---|--------------------------------------|------|----|
| V_{IN} | Input Voltage | -0.3 to 6.5 | V | |
| V_{LX} | LX Pin Voltage | -0.3 to $V_{IN} + 0.3$ | V | |
| V_{CE} | CE Pin Voltage | -0.3 to 6.5 | V | |
| V_{MODE} | MODE Pin Voltage | -0.3 to 6.5 | V | |
| V_{OUT}/V_{FB} | VOUT/VFB Pin Voltage | -0.3 to 6.5 | V | |
| I_{LX} | LX Pin Output Current | 1.6 | A | |
| P_D | Power Dissipation ⁽¹⁾ (WLCSP6-P6) | JEDEC STD. 51-9 Test Land Pattern | 910 | mW |
| | Power Dissipation (SOT-23-6) | | TBD | mW |
| T_j | Junction Temperature | -40 to 125 | °C | |
| T_{stg} | Storage Temperature Range | -55 to 125 | °C | |

ABSOLUTE MAXIMUM RATINGS

Electronic and mechanical stress momentarily exceeded absolute maximum ratings may cause the permanent damages and may degrade the lifetime and safety for both device and system using the device in the field. The functional operation at or over these absolute maximum ratings is not assured.

RECOMMENDED OPERATING CONDITIONS

| Symbol | Item | Rating | Unit |
|----------|-----------------------------|------------|------|
| V_{IN} | Input Voltage | 2.3 to 5.5 | V |
| T_a | Operating Temperature Range | -40 to 85 | °C |

RECOMMENDED OPERATING CONDITIONS

All of electronic equipment should be designed that the mounted semiconductor devices operate within the recommended operating conditions. The semiconductor devices cannot operate normally over the recommended operating conditions, even if when they are used over such conditions by momentary electronic noise or surge. And the semiconductor devices may receive serious damage when they continue to operate over the recommended operating conditions.

⁽¹⁾ Refer to *POWER DISSIPATION* for detailed information.

ELECTRICAL CHARACTERISTICS

Test circuit is operated with "Open Loop Control" (GND = 0 V), unless otherwise specified.

RP509Zxx1A/B, RP509Nxx1A/B **《under development》** Electrical Characteristics (Ta = 25°C)

| Symbol | Item | Conditions | Min. | Typ. | Max. | Unit | |
|------------------------|--|--|--|---------|---------|--------|---|
| V _{OUT} | Output Voltage | V _{IN} = V _{CE} = 3.6 V (V _{SET} ≤ 2.6 V), V _{IN} = V _{CE} = V _{SET} + 1 V (V _{SET} > 2.6 V) | V _{SET} ≥ 1.2 V | x 0.985 | x 1.015 | V | |
| | | | V _{SET} < 1.2 V | -0.018 | +0.018 | | |
| ΔV _{OUT} /ΔTa | Output Voltage Temperature Coefficient | -40 °C ≤ Ta ≤ 85 °C | | ±100 | | ppm/°C | |
| f _{OSC} | Oscillator Frequency | V _{IN} = V _{CE} = 3.6 V, V _{SET} = 1.8 V, "Closed Loop Control" | 4.8 | 6.0 | 7.2 | MHz | |
| I _{DD} | Supply Current | V _{IN} = V _{CE} = V _{OUT} = 3.6 V, V _{MODE} = 0 V | | 15 | | μA | |
| I _{STANDBY} | Standby Current | V _{IN} = 5.5 V, V _{CE} = 0 V | | 0 | 5 | μA | |
| I _{CEH} | CE "High" Input Current | V _{IN} = V _{CE} = 5.5 V | -1 | 0 | 1 | μA | |
| I _{CEL} | CE "Low" Input Current | V _{IN} = 5.5 V, V _{CE} = 0 V | -1 | 0 | 1 | μA | |
| I _{MODEH} | MODE "High" Input Current | V _{IN} = V _{MODE} = 5.5 V, V _{CE} = 0 V | -1 | 0 | 1 | μA | |
| I _{MODEL} | MODE "Low" Input Current | V _{IN} = 5.5 V, V _{CE} = V _{MODE} = 0 V | -1 | 0 | 1 | μA | |
| I _{VOUTH} | V _{OUT} "High" Input Current | V _{IN} = V _{OUT} = 5.5 V, V _{CE} = 0 V | -1 | 0 | 1 | μA | |
| I _{VOUTL} | V _{OUT} "Low" Input Current | V _{IN} = 5.5 V, V _{CE} = V _{OUT} = 0 V | -1 | 0 | 1 | μA | |
| R _{DISTR} | On-resistance for Auto Discharger ⁽¹⁾ | V _{IN} = 3.6 V, V _{CE} = 0 V | | 40 | | Ω | |
| I _{LXLEAKH} | LX "High" Leakage Current | V _{IN} = V _{LX} = 5.5 V, V _{CE} = 0 V | -1 | 0 | 5 | μA | |
| I _{LXLEAKL} | LX "Low" Leakage Current | V _{IN} = 5.5 V, V _{CE} = V _{LX} = 0 V | -5 | 0 | 1 | μA | |
| V _{CEH} | CE "High" Input Voltage | V _{IN} = 5.5 V | 1.0 | | | V | |
| V _{CEL} | CE "Low" Input Voltage | V _{IN} = 2.3 V | | | 0.4 | V | |
| V _{MODEH} | MODE "High" Input Voltage | V _{IN} = V _{CE} = 5.5 V | 1.0 | | | V | |
| V _{MODEL} | MODE "Low" Input Voltage | V _{IN} = V _{CE} = 2.3 V | | | 0.4 | V | |
| R _{ONP} | On-resistance of Pch. transistor | RP509Z | V _{IN} = 3.6V, I _{LX} = -100mA | | 0.175 | | Ω |
| | | RP509N | | | TBD | | Ω |
| R _{ONN} | On-resistance of Nch. transistor | RP509Z | V _{IN} = 3.6V, I _{LX} = -100mA | | 0.155 | | Ω |
| | | RP509N | | | TBD | | Ω |
| Maxduty | Maximum Duty Cycle | | 100 | | | % | |
| t _{START} | Soft-start Time | V _{IN} = V _{CE} = 3.6 V (V _{SET} ≤ 2.6 V), V _{IN} = V _{CE} = V _{SET} + 1 V (V _{SET} > 2.6 V) | | 150 | 300 | μs | |
| I _{LXLIM} | LX Current Limit | V _{IN} = V _{CE} = 3.6 V (V _{SET} ≤ 2.6 V), V _{IN} = V _{CE} = V _{SET} + 1 V (V _{SET} > 2.6 V) | 1200 | 1600 | | mA | |
| V _{UVLO1} | UVLO Threshold Voltage | V _{IN} = V _{CE} , Falling | 1.85 | 2.00 | 2.20 | V | |
| V _{UVLO2} | | V _{IN} = V _{CE} , Rising | 1.90 | 2.05 | 2.25 | V | |
| T _{TSD} | Thermal Shutdown Threshold Temperature | T _j , Rising | | 140 | | °C | |
| T _{TSR} | | T _j , Falling | | 100 | | °C | |

All test items listed under Electrical Characteristics are done under the pulse load condition (T_j ≈ Ta = 25°C).

⁽¹⁾ RP509xxx1B only

RP509x

NO.EA-362-160510

Test circuit is operated with "Open Loop Control" (GND = 0 V), unless otherwise specified.

RP509Z001C/D, RP509N001C/D **《under development》** Electrical Characteristics (Ta = 25°C)

| Symbol | Item | Conditions | Min. | Typ. | Max. | Unit | |
|-----------------------|---|--|--|-------|-------|--------|---|
| V _{FB} | Feedback Voltage | V _{IN} = V _{CE} = 3.6 V | 0.591 | 0.600 | 0.609 | V | |
| ΔV _{FB} /ΔTa | Feedback Voltage Temperature Coefficient | -40 °C ≤ Ta ≤ 85 °C | | ±100 | | ppm/°C | |
| f _{OSC} | Oscillator Frequency | V _{IN} = V _{CE} = 3.6 V, V _{SET} = 1.8 V, "Closed Loop Control" | 4.8 | 6.0 | 7.2 | MHz | |
| I _{DD} | Supply Current | V _{IN} = V _{CE} = V _{OUT} = 3.6V, V _{MODE} = 0V | | 15 | | μA | |
| I _{STANDBY} | Standby Current | V _{IN} = 5.5 V, V _{CE} = 0 V | | 0 | 5 | μA | |
| I _{CEH} | CE "High" Input Current | V _{IN} = V _{CE} = 5.5 V | -1 | 0 | 1 | μA | |
| I _{CEL} | CE "Low" Input Current | V _{IN} = 5.5 V, V _{CE} = 0 V | -1 | 0 | 1 | μA | |
| I _{MODEH} | MODE "High" Input Current | V _{IN} = V _{MODE} = 5.5 V, V _{CE} = 0 V | -1 | 0 | 1 | μA | |
| I _{MODEL} | MODE "Low" Input Current | V _{IN} = 5.5 V, V _{CE} = V _{MODE} = 0 V | -1 | 0 | 1 | μA | |
| I _{VOUTH} | V _{OUT} "High" Input Current | V _{IN} = V _{OUT} = 5.5 V, V _{CE} = 0 V | -1 | 0 | 1 | μA | |
| I _{VOUTL} | V _{OUT} "Low" Input Current | V _{IN} = 5.5 V, V _{CE} = V _{OUT} = 0 V | -1 | 0 | 1 | μA | |
| R _{DISTR} | On-resistance for Auto Discharge ⁽¹⁾ | V _{IN} = 3.6 V, V _{CE} = 0 V | | 40 | | Ω | |
| I _{LXLEAKH} | LX "High" Leakage Current | V _{IN} = V _{LX} = 5.5 V, V _{CE} = 0 V | -1 | 0 | 5 | μA | |
| I _{LXLEAKL} | LX "Low" Leakage Current | V _{IN} = 5.5 V, V _{CE} = V _{LX} = 0 V | -5 | 0 | 1 | μA | |
| V _{CEH} | CE "High" Input Voltage | V _{IN} = 5.5 V | 1.0 | | | V | |
| V _{CEL} | CE "Low" Input Voltage | V _{IN} = 2.3 V | | | 0.4 | V | |
| V _{MODEH} | MODE "High" Input Voltage | V _{IN} = V _{CE} = 5.5 V | 1.0 | | | V | |
| V _{MODEL} | MODE "Low" Input Voltage | V _{IN} = V _{CE} = 2.3 V | | | 0.4 | V | |
| R _{ONP} | On-resistance of Pch. Transistor | RP509Z | V _{IN} = 3.6V, I _{LX} = -100mA | | 0.175 | | Ω |
| | | RP509N | | | TBD | | Ω |
| R _{ONN} | On-resistance of Nch. Transistor | RP509Z | V _{IN} = 3.6V, I _{LX} = -100mA | | 0.155 | | Ω |
| | | RP509N | | | TBD | | Ω |
| Maxduty | Maximum Duty Cycle | | 100 | | | % | |
| t _{START} | Soft-start Time | V _{IN} = V _{CE} = 3.6 V (V _{SET} ≤ 2.6 V), V _{IN} = V _{CE} = V _{SET} + 1 V (V _{SET} > 2.6 V) | | 150 | 300 | μs | |
| I _{LXLIM} | LX Current Limit | V _{IN} = V _{CE} = 3.6 V (V _{SET} ≤ 2.6 V), V _{IN} = V _{CE} = V _{SET} + 1 V (V _{SET} > 2.6 V) | 1200 | 1600 | | mA | |
| V _{UVLO1} | UVLO Threshold Voltage | V _{IN} = V _{CE} , Falling | 1.85 | 2.00 | 2.20 | V | |
| V _{UVLO2} | | V _{IN} = V _{CE} , Rising | 1.90 | 2.05 | 2.25 | V | |
| T _{TSD} | Thermal Shutdown Threshold Temperature | T _j , Rising | | 140 | | °C | |
| T _{TSR} | | T _j , Falling | | 100 | | °C | |

All test items listed under Electrical Characteristics are done under the pulse load condition (T_j ≈ Ta = 25°C).

⁽¹⁾ RP509x001D only

Test circuit is operated with "Open Loop Control" (GND = 0 V), unless otherwise specified.

RP509Zxx2A/B, RP509Nxx2A/B **《under development》** Electrical Characteristics (Ta = 25°C)

| Symbol | Item | Conditions | Min. | Typ. | Max. | Unit | |
|------------------------|--|--|--|---------|-------|---------|--------|
| V _{OUT} | Output Voltage | V _{IN} = V _{CE} = 3.6 V (V _{SET} ≤ 2.6 V), V _{IN} = V _{CE} = V _{SET} + 1 V (V _{SET} > 2.6 V) | V _{SET} ≥ 1.2 V | x 0.985 | | x 1.015 | V |
| | | | V _{SET} < 1.2 V | -0.018 | | +0.018 | |
| ΔV _{OUT} /ΔTa | Output Voltage Temperature Coefficient | -40 °C ≤ Ta ≤ 85 °C | | | ±100 | | ppm/°C |
| f _{OSC} | Oscillator Frequency | V _{IN} = V _{CE} = 3.6 V, V _{SET} = 1.8 V, "Closed Loop Control" | | 4.8 | 6.0 | 7.2 | MHz |
| I _{DD} | Supply Current | V _{IN} = V _{CE} = V _{OUT} = 3.6V, V _{MODE} = 0V | | | 15 | | μA |
| I _{STANDBY} | Standby Current | V _{IN} = 5.5 V, V _{CE} = 0 V | | | 0 | 5 | μA |
| I _{CEH} | CE "High" Input Current | V _{IN} = V _{CE} = 5.5 V | | -1 | 0 | 1 | μA |
| I _{CEL} | CE "Low" Input Current | V _{IN} = 5.5 V, V _{CE} = 0 V | | -1 | 0 | 1 | μA |
| I _{MODEH} | MODE "High" Input Current | V _{IN} = V _{MODE} = 5.5 V, V _{CE} = 0 V | | -1 | 0 | 1 | μA |
| I _{MODEL} | MODE "Low" Input Current | V _{IN} = 5.5 V, V _{CE} = V _{MODE} = 0 V | | -1 | 0 | 1 | μA |
| I _{VOUTH} | V _{OUT} "High" Input Current | V _{IN} = V _{OUT} = 5.5 V, V _{CE} = 0 V | | -1 | 0 | 1 | μA |
| I _{VOUTL} | V _{OUT} "Low" Input Current | V _{IN} = 5.5 V, V _{CE} = V _{OUT} = 0 V | | -1 | 0 | 1 | μA |
| R _{DISTR} | On-resistance for Auto Discharger ⁽¹⁾ | V _{IN} = 3.6 V, V _{CE} = 0 V | | | 40 | | Ω |
| I _{LXLEAKH} | LX "High" Leakage Current | V _{IN} = V _{LX} = 5.5 V, V _{CE} = 0 V | | -1 | 0 | 5 | μA |
| I _{LXLEAKL} | LX "Low" Leakage Current | V _{IN} = 5.5 V, V _{CE} = V _{LX} = 0 V | | -5 | 0 | 1 | μA |
| V _{CEH} | CE "High" Input Voltage | V _{IN} = 5.5 V | | 1.0 | | | V |
| V _{CEL} | CE "Low" Input Voltage | V _{IN} = 2.3 V | | | | 0.4 | V |
| V _{MODEH} | MODE "High" Input Voltage | V _{IN} = V _{CE} = 5.5 V | | 1.0 | | | V |
| V _{MODEL} | MODE "Low" Input Voltage | V _{IN} = V _{CE} = 2.3 V | | | | 0.4 | V |
| R _{ONP} | On-resistance of Pch. transistor | RP509Z | V _{IN} = 3.6V, I _{LX} = -100mA | | 0.175 | | Ω |
| | | RP509N | | | TBD | | Ω |
| R _{ONN} | On-resistance of Nch. transistor | RP509Z | V _{IN} = 3.6V, I _{LX} = -100mA | | 0.155 | | Ω |
| | | RP509N | | | TBD | | Ω |
| Maxduty | Maximum Duty Cycle | | | 100 | | | % |
| t _{START} | Soft-start Time | V _{IN} = V _{CE} = 3.6 V (V _{SET} ≤ 2.6 V), V _{IN} = V _{CE} = V _{SET} + 1 V (V _{SET} > 2.6 V) | | | 150 | 300 | μs |
| I _{LXLIM} | LX Current Limit | V _{IN} = V _{CE} = 3.6 V (V _{SET} ≤ 2.6 V), V _{IN} = V _{CE} = V _{SET} + 1 V (V _{SET} > 2.6 V) | | 600 | 1000 | | mA |
| V _{UVLO1} | UVLO Threshold Voltage | V _{IN} = V _{CE} , Falling | | 1.85 | 2.00 | 2.20 | V |
| V _{UVLO2} | | V _{IN} = V _{CE} , Rising | | 1.90 | 2.05 | 2.25 | V |
| T _{TSD} | Thermal Shutdown Threshold Temperature | T _j , Rising | | | 140 | | °C |
| T _{TSR} | | T _j , Falling | | | 100 | | °C |

All test items listed under Electrical Characteristics are done under the pulse load condition (T_j ≈ Ta = 25°C).

⁽¹⁾ RP509xxx2B only

RP509x

NO.EA-362-160510

Test circuit is operated with "Open Loop Control" (GND = 0 V), unless otherwise specified.

RP509Z002C/D, RP509N002C/D **《under development》** Electrical Characteristics (Ta = 25°C)

| Symbol | Item | Conditions | Min. | Typ. | Max. | Unit |
|-----------------------|---|--|--|-------|-------|--------|
| V _{FB} | Feedback Voltage | V _{IN} = V _{CE} = 3.6 V | 0.591 | 0.600 | 0.609 | V |
| ΔV _{FB} /ΔTa | Feedback Voltage Temperature Coefficient | -40 °C ≤ Ta ≤ 85 °C | | ±100 | | ppm/°C |
| f _{OSC} | Oscillator Frequency | V _{IN} = V _{CE} = 3.6 V, V _{SET} = 1.8 V, "Closed Loop Control" | 4.8 | 6.0 | 7.2 | MHz |
| I _{DD} | Supply Current | V _{IN} = V _{CE} = V _{OUT} = 3.6V, V _{MODE} = 0V | | 15 | | μA |
| I _{STANDBY} | Standby Current | V _{IN} = 5.5 V, V _{CE} = 0 V | | 0 | 5 | μA |
| I _{CEH} | CE "High" Input Current | V _{IN} = V _{CE} = 5.5 V | -1 | 0 | 1 | μA |
| I _{CEL} | CE "Low" Input Current | V _{IN} = 5.5 V, V _{CE} = 0 V | -1 | 0 | 1 | μA |
| I _{MODEH} | MODE "High" Input Current | V _{IN} = V _{MODE} = 5.5 V, V _{CE} = 0 V | -1 | 0 | 1 | μA |
| I _{MODEL} | MODE "Low" Input Current | V _{IN} = 5.5 V, V _{CE} = V _{MODE} = 0 V | -1 | 0 | 1 | μA |
| I _{VOUTH} | V _{OUT} "High" Input Current | V _{IN} = V _{OUT} = 5.5 V, V _{CE} = 0 V | -1 | 0 | 1 | μA |
| I _{VOU TL} | V _{OUT} "Low" Input Current | V _{IN} = 5.5 V, V _{CE} = V _{OUT} = 0 V | -1 | 0 | 1 | μA |
| R _{DISTR} | On-resistance for Auto Discharge ⁽¹⁾ | V _{IN} = 3.6 V, V _{CE} = 0 V | | 40 | | Ω |
| I _{LXLEAKH} | LX "High" Leakage Current | V _{IN} = V _{LX} = 5.5 V, V _{CE} = 0 V | -1 | 0 | 5 | μA |
| I _{LXLEAKL} | LX "Low" Leakage Current | V _{IN} = 5.5 V, V _{CE} = V _{LX} = 0 V | -5 | 0 | 1 | μA |
| V _{CEH} | CE "High" Input Voltage | V _{IN} = 5.5 V | 1.0 | | | V |
| V _{CEL} | CE "Low" Input Voltage | V _{IN} = 2.3 V | | | 0.4 | V |
| V _{MODEH} | MODE "High" Input Voltage | V _{IN} = V _{CE} = 5.5 V | 1.0 | | | V |
| V _{MODEL} | MODE "Low" Input Voltage | V _{IN} = V _{CE} = 2.3 V | | | 0.4 | V |
| R _{ONP} | On-resistance of Pch. Transistor | RP509Z | V _{IN} = 3.6V, I _{LX} = -100mA | | 0.175 | Ω |
| | | RP509N | | | TBD | Ω |
| R _{ONN} | On-resistance of Nch. Transistor | RP509Z | V _{IN} = 3.6V, I _{LX} = -100mA | | 0.155 | Ω |
| | | RP509N | | | TBD | Ω |
| Maxduty | Maximum Duty Cycle | | 100 | | | % |
| t _{START} | Soft-start Time | V _{IN} = V _{CE} = 3.6 V (V _{SET} ≤ 2.6 V), V _{IN} = V _{CE} = V _{SET} + 1 V (V _{SET} > 2.6 V) | | 150 | 300 | μs |
| I _{LXLIM} | LX Current Limit | V _{IN} = V _{CE} = 3.6 V (V _{SET} ≤ 2.6 V), V _{IN} = V _{CE} = V _{SET} + 1 V (V _{SET} > 2.6 V) | 600 | 1000 | | mA |
| V _{UVLO1} | UVLO Threshold Voltage | V _{IN} = V _{CE} , Falling | 1.85 | 2.00 | 2.20 | V |
| V _{UVLO2} | | V _{IN} = V _{CE} , Rising | 1.90 | 2.05 | 2.25 | V |
| T _{TSD} | Thermal Shutdown | T _j , Rising | | 140 | | °C |
| T _{TSR} | Threshold Temperature | T _j , Falling | | 100 | | °C |

All test items listed under Electrical Characteristics are done under the pulse load condition (T_j ≈ Ta = 25°C).

⁽¹⁾ RP509x002D only

Electrical Characteristics by Different Output Voltage
RP509ZxxXA/B, RP509NxxXA/B 《under development》 (Fixed Output Voltage Type) (Ta = 25°C)

| Product Name | V _{OUT} [V] (Ta = 25°C) | | |
|--------------|----------------------------------|-------|-------|
| | Min. | Typ. | Max. |
| RP509x06XA/B | 0.582 | 0.600 | 0.618 |
| RP509x07XA/B | 0.682 | 0.700 | 0.718 |
| RP509x08XA/B | 0.782 | 0.800 | 0.818 |
| RP509x09XA/B | 0.882 | 0.900 | 0.918 |
| RP509x10XA/B | 0.982 | 1.000 | 1.018 |
| RP509x11XA/B | 1.082 | 1.100 | 1.118 |
| RP509x12XA/B | 1.182 | 1.200 | 1.218 |
| RP509x13XA/B | 1.281 | 1.300 | 1.319 |
| RP509x14XA/B | 1.379 | 1.400 | 1.421 |
| RP509x15XA/B | 1.478 | 1.500 | 1.522 |
| RP509x16XA/B | 1.576 | 1.600 | 1.624 |
| RP509x17XA/B | 1.675 | 1.700 | 1.725 |
| RP509x18XA/B | 1.773 | 1.800 | 1.827 |
| RP509x19XA/B | 1.872 | 1.900 | 1.928 |
| RP509x20XA/B | 1.970 | 2.000 | 2.030 |
| RP509x21XA/B | 2.069 | 2.100 | 2.131 |
| RP509x22XA/B | 2.167 | 2.200 | 2.233 |
| RP509x23XA/B | 2.266 | 2.300 | 2.334 |
| RP509x24XA/B | 2.364 | 2.400 | 2.436 |
| RP509x25XA/B | 2.463 | 2.500 | 2.537 |
| RP509x26XA/B | 2.561 | 2.600 | 2.639 |
| RP509x27XA/B | 2.660 | 2.700 | 2.740 |
| RP509x28XA/B | 2.758 | 2.800 | 2.842 |
| RP509x29XA/B | 2.857 | 2.900 | 2.943 |
| RP509x30XA/B | 2.955 | 3.000 | 3.045 |
| RP509x31XA/B | 3.054 | 3.100 | 3.146 |
| RP509x32XA/B | 3.152 | 3.200 | 3.248 |
| RP509x33XA/B | 3.251 | 3.300 | 3.349 |

OPERATING DESCRIPTIONS

Soft-start Time

Starting-up with CE Pin

The IC starts to operate when the CE pin voltage (V_{CE}) exceeds the threshold voltage. The threshold voltage is preset between CE "H" input voltage (V_{CEH}) and CE "L" input voltage (V_{CEL}).

After the start-of the start-up of the IC, soft-start circuit starts to operate. Then, after a certain period of time, the reference voltage (V_{REF}) in the IC gradually increases up to the specified value.

Notes: Soft start time (t_{START})⁽¹⁾ is not always equal to the turn-on speed of the step-down DC/DC converter. Please note that the turn-on speed could be affected by the power supply capacity, the output current, the inductance value and the C_{OUT} value.

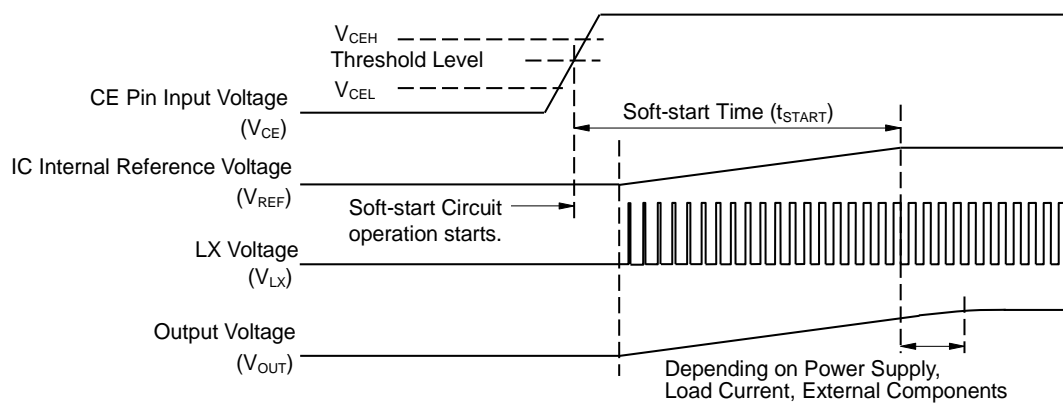

Timing Chart when Starting-up with CE Pin

⁽¹⁾ Soft-start time (t_{START}) indicates the duration until the reference voltage (V_{REF}) reaches the specified voltage after soft-start circuit's activation.

Starting-up with Power Supply

After the power-on, when V_{IN} exceeds the UVLO released voltage (V_{UVLO2}), the IC starts to operate. Then, soft-start circuit starts to operate and after a certain period of time, V_{REF} gradually increases up to the specified value.

Notes: Please note that the turn-on speed of V_{OUT} could be affected by the power supply capacity, the output current, the inductance value, the C_{OUT} value and the turn-on speed of V_{IN} determined by C_{IN} .

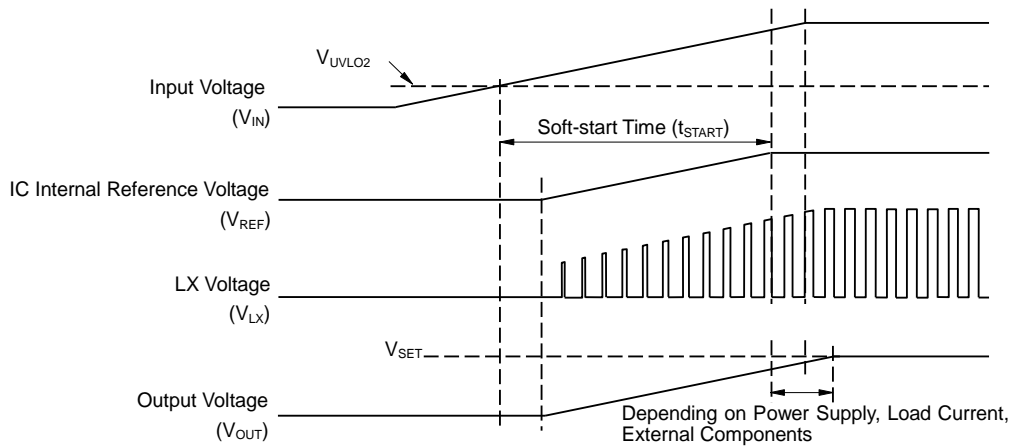

Timing Chart when Starting-up with Power Supply

Under Voltage Lockout (UVLO) Circuit

If V_{IN} becomes lower than V_{SET} , the step-down DC/DC converter stops the switching operation and ON duty becomes 100%, and then V_{OUT} gradually drops according to V_{IN} .

If the V_{IN} drops more and becomes lower than the UVLO detector threshold (V_{UVLO1}), the UVLO circuit starts to operate, V_{REF} stops, and Pch. and Nch. built-in switch transistors turn "OFF". As a result, V_{OUT} drops according to the C_{OUT} capacitance value and the load.

To restart the operation, V_{IN} needs to be higher than V_{UVLO2} . The timing chart below shows the voltage shifts of V_{REF} , V_{LX} and V_{OUT} when V_{IN} value is varied.

Notes: Falling edge (operating) and rising edge (releasing) waveforms of V_{OUT} could be affected by the initial voltage of C_{OUT} and the output current of V_{OUT} .

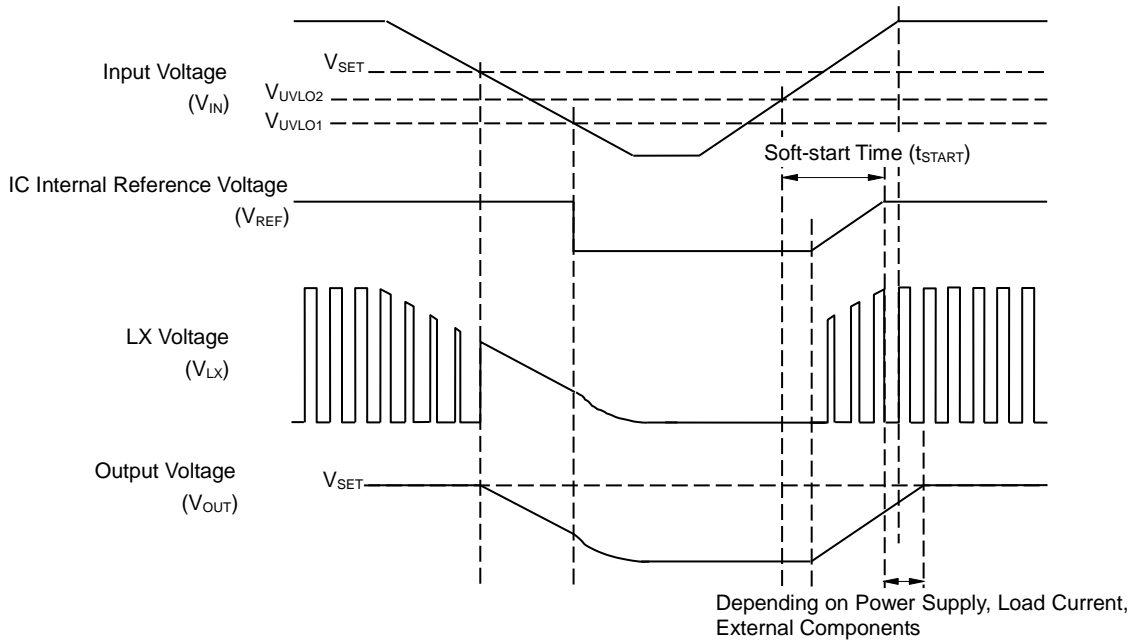

Timing Chart with Variations in Input Voltage (V_{IN})

Current limit Circuit

Current limit circuit supervises the inductor peak current (the peak current flowing through Pch. Tr.) in each switching cycle, and if the current exceeds the LX current limit (I_{LXLIM}), it turns off Pch. Tr. I_{LXLIM} of the RP509x is set to Typ.1.6 A or Typ.1.0 A.

Notes: I_{LXLIM} could be easily affected by self-heating or ambient environment. If the V_{IN} drops dramatically or becomes unstable due to short-circuit, protection operation could be affected.

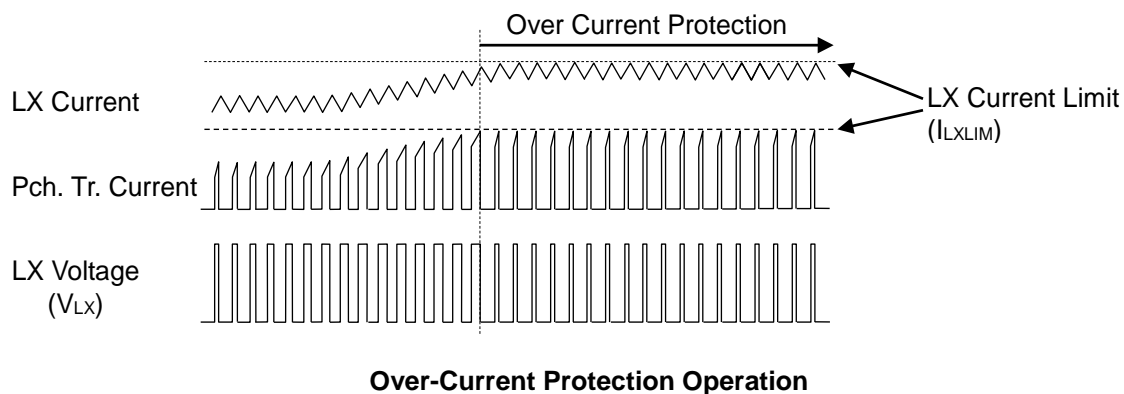

Operation of Step-down DC/DC Converter and Output Current

The step-down DC/DC converter charges energy in the inductor when LX Tr. turns “ON”, and discharges the energy from the inductor when LX Tr. turns “OFF” and controls with less energy loss, so that a lower output voltage (V_{OUT}) than the input voltage (V_{IN}) can be obtained. The operation of the step-down DC/DC converter is explained in the following figures.

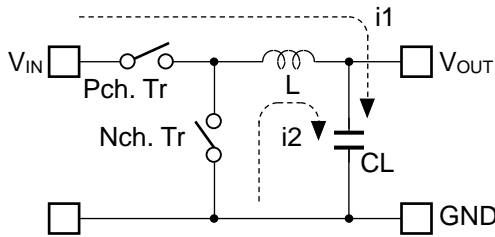

Basic Circuit

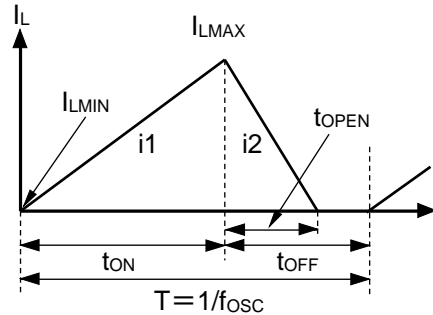

Inductor Current (I_L) flowing through Inductor (L)

- Step1.** Pch. Tr. turns “ON” and I_L ($i1$) flows, L is charged with energy. At this moment, $i1$ increases from the minimum inductor current (I_{LMIN}), which is 0 A, and reaches the maximum inductor current (I_{LMAX}) in proportion to the on-time period (t_{ON}) of Pch. Tr.
- Step2.** When Pch. Tr. turns “OFF”, L tries to maintain I_L at I_{LMAX} , so L turns Nch Tr. “ON” and I_L ($i2$) flows into L.
- Step3.** $i2$ decreases gradually and reaches I_{LMIN} after the open-time period (t_{OPEN}) of Nch. Tr., and then Nch. Tr. turns “OFF”. This is called discontinuous current mode.
As the output current (I_{OUT}) increases, the off-time period (t_{OFF}) of Pch. Tr. runs out before I_L reaches I_{LMIN} . The next cycle starts, and Pch. Tr. turns “ON” and Nch. Tr. turns “OFF”, which means I_L starts increasing from I_{LMIN} . This is called continuous current mode.

In PWM mode, V_{OUT} is maintained by controlling t_{on} . The oscillator frequency (f_{osc}) is maintained constant during PWM mode.

When the step-down DC/DC operation is constant, I_{LMIN} and I_{LMAX} during t_{on} of Pch. Tr. would be same as during t_{OFF} of Pch. Tr. The current differential between I_{LMAX} and I_{LMIN} is described as ΔI , as the following equation 1.

$$\Delta I = I_{LMAX} - I_{LMIN} = V_{OUT} \times t_{OPEN} / L = (V_{IN} - V_{OUT}) \times t_{ON} / L \dots\dots\dots \text{Equation 1}$$

The above equation is predicated on the following requirements.

- $T = 1 / f_{osc} = t_{ON} + t_{OFF}$
- duty (%) = $t_{ON} / T \times 100 = t_{ON} \times f_{osc} \times 100$
- $t_{OPEN} \leq t_{OFF}$

In Equation 1, “ $V_{OUT} \times t_{OPEN} / L$ ” shows the amount of current change in “OFF” state. Also, “ $(V_{IN} - V_{OUT}) \times t_{ON} / L$ ” shows the amount of current change at “ON” state.

Discontinuous Mode and Continuous Mode

As illustrated in Figure A., when I_{OUT} is relatively small, $t_{OPEN} < t_{OFF}$. In this case, the energy charged into L during t_{ON} will be completely discharged during t_{OFF} , as a result, $I_{LMIN} = 0$. This is called discontinuous mode. When I_{OUT} is gradually increased, eventually $t_{OPEN} = t_{OFF}$ and when I_{OUT} is increased further, eventually $I_{LMIN} > 0$ as illustrated in Figure B. This is called continuous mode.

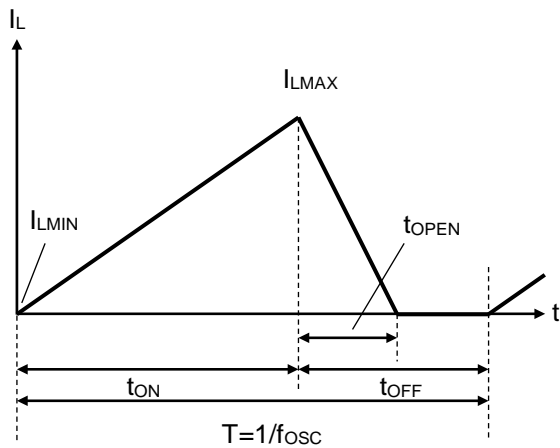

Figure A. Discontinuous Mode

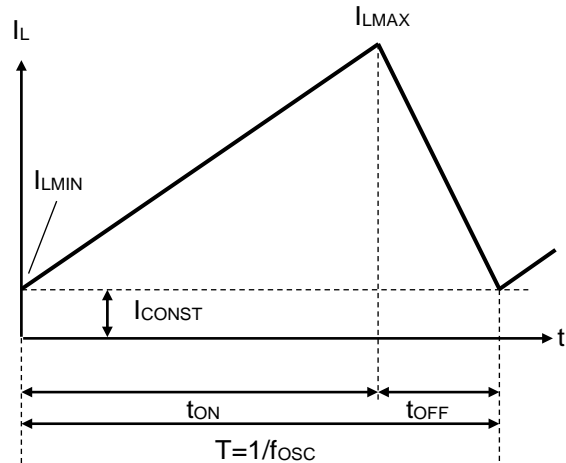

Figure B. Continuous Mode

In the continuous mode, the solution of Equation 1 is described as t_{ONC} .

$$t_{ONC} = T \times V_{OUT} / V_{IN} \dots\dots\dots \text{Equation 2}$$

When $t_{ON} < t_{ONC}$, it is discontinuous mode, and when $t_{ON} = t_{ONC}$, it is continuous mode.

Forced PWM Mode and VFM Mode

Output voltage controlling method is selectable between a forced PWM control type and a PWM/VFM auto-switching control type, and can be set by the MODE pin. The forced PWM control switches at fixed frequency rate in order to reduce noise in low output current. The PWM/VFM auto-switching control automatically switches from PWM mode to VFM mode in order to achieve high efficiency in low output current.

Forced PWM Mode

By setting the MODE pin to "H", the IC switches the frequency at the fixed rate to reduce noise even when the output load is light. Therefore, when I_{OUT} is $\Delta I_L/2$ or less, I_{LMIN} becomes less than "0". That is, the accumulated electricity in CL is discharged through the IC side while I_L is increasing from I_{LMIN} to "0" during t_{ON} , and also while I_L is decreasing from "0" to I_{LMIN} during t_{OFF} .

VFM Mode

By setting the MODE pin to "L", in low output current, the IC automatically switches into VFM mode in order to achieve high efficiency. In VFM mode, t_{ON} is determined depending on V_{IN} and V_{OUT} .

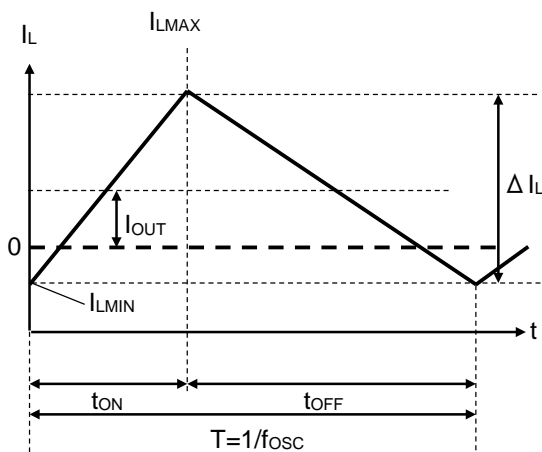
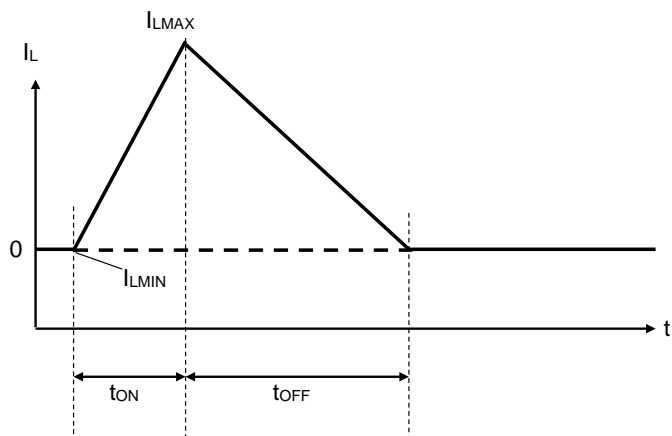
**Forced PWM Mode****VFM Mode**

APPLICATION INFORMATION

Application Circuits

MODE = "H": forced PWM control, MODE = "L": PWM/VFM auto-switching control

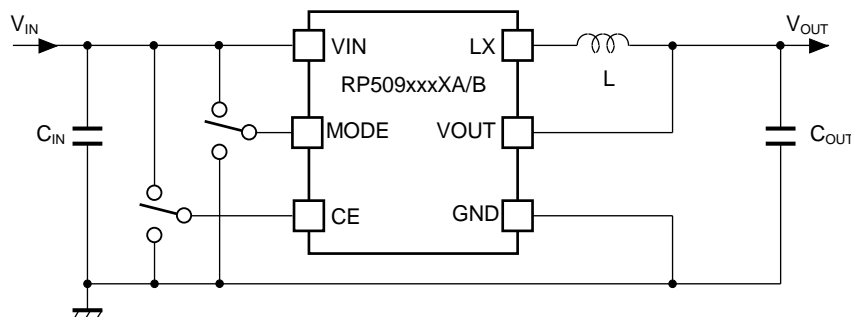

RP509xxxXA/B (Fixed Output Voltage Type)

MODE = "H": forced PWM control, MODE = "L": PWM/VFM auto-switching control

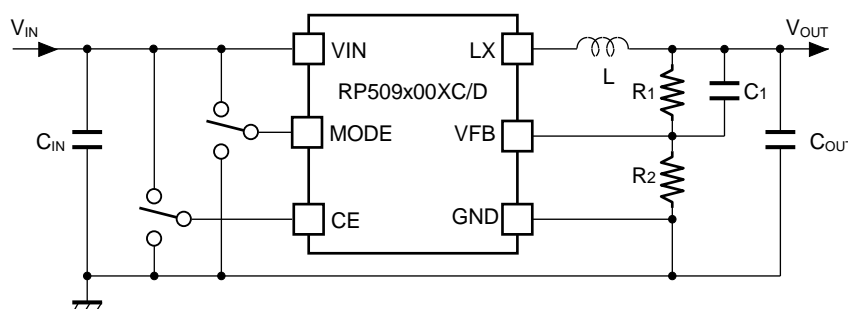

RP509x00XC/D (Adjustable Output Voltage Type)

Recommended External Components

| Symbol | Descriptions |
|------------------|---|
| C _{IN} | 4.7 μF and more, Ceramic Capacitor, See the table of "Input Voltage vs. Capacitance" in the following page. |
| C _{OUT} | 10 μF, Ceramic Capacitor, See the table of "Set Output Voltage (V _{SET}) vs. Capacitance" in the following page. |
| L | 0.47 μH to 0.56 μH, See the table of "Inductance Range vs. PWM Frequency" in the following page. |

RP509x

NO.EA-362-160510

Input Voltage vs. Capacitance

| V_{IN} [V] | Size [mm] | C_{IN} [μ F] | Rated Voltage [V] | Model |
|--------------|-----------|---------------------|-------------------|--|
| Up to 4.5 | 1005 | 4.7 | 6.3 | JMK105BBJ475MV (Taiyo Yuden) |
| | | 10 | 6.3 | C1005X5R0J106M050BC (TDK) |
| | 1608 | 4.7 | 6.3 | GRM188R60J475ME84 (Murata) GRM188R60J475ME19 (Murata) C1608X5R0J475M080AB (TDK) JMK107BJ475MA (Taiyo Yuden) |
| | | 10 | 6.3 | GRM188R60J106ME47 (Murata) C1608X5R0J106M080AB (TDK) JMK107ABJ106MA (Taiyo Yuden) |
| Up to 5.5 | 1005 | 10 | 6.3 | C1005X5R0J106M050BC (TDK) |
| | 1608 | 4.7 | 6.3 | GRM188R60J475ME84 (Murata) GRM188R60J475ME19 (Murata) JMK107BJ475MA (Taiyo Yuden) |
| | | 10 | 6.3 | GRM188R60J106ME47 (Murata) C1608X5R0J106M080AB (TDK) JMK107ABJ106MA (Taiyo Yuden) |

Set Output Voltage (V_{SET}) vs. Capacitance

| Version | V_{SET} [V] | Size [mm] | C_{OUT} [μ F] | Rated Voltage [V] | Model |
|-------------------------------------|---------------|-----------|----------------------|-------------------|---|
| RP509xxxXA/B or RP509x00X/C/D | 0.6 to 1.8 | 1005 | 10 | 4 | GRM155R60G106ME44 (Murata) C1005X5R0G106M050BB (TDK) AMK105CBJ106MV (Taiyo Yuden) |
| | | | 10 | 6.3 | C1005X5R0J106M050BC (TDK) |
| | | 1608 | 10 | 6.3 | GRM188R60J106ME47 (Murata) C1608X5R0J106M080AB (TDK) JMK107ABJ106MA (Taiyo Yuden) |
| | | | 1005 | 10 | 4 |
| | 1.9 to 3.3 | 1608 | | 10 | 6.3 |
| | | | 10 | 6.3 | GRM188R60J106ME47 (Murata) C1608X5R0J106M080AB (TDK) JMK107ABJ106MA (Taiyo Yuden) |
| RP509x00XC/D | 3.4 to 4.5 | 1608 | 10 | 6.3 | GRM188R60J106ME47 (Murata) C1608X5R0J106M080AB (TDK) JMK107ABJ106MA (Taiyo Yuden) |

Inductance Range vs. PWM Frequency

| Version | PWM Frequency [MHz] | Size [mm] | Height(Max) [mm] | L [μH] | Rdc(Typ) [mΩ] | Model |
|------------------------------------|---------------------|-----------|------------------|--------|---------------|------------------------------|
| RP509xxxXA/B or RP509x00XC/D | 6.0 | 1608 | 0.95 | 0.47 | 110 | MDT1608-CHR47M (TOKO) |
| | | | | | 90 | MDT1608-CRR47M (TOKO) |
| | | 2012 | 1.0 | 0.5 | 60 | MIPSZ2012D0R5 (FDK) |
| | | | | 0.56 | 65 | MDT2012-CRR56N (TOKO) |
| | | | | 0.47 | 70 | MLP2012HR47MT (TDK) |
| | | | | 0.54 | 65 | MLP2012HR54MT (TDK) |
| | | | | 0.47 | 60 | CKP2012NR47M-T (Taiyo Yuden) |
| | | | | 0.47 | 48 | BRL2012TR47M6 (Taiyo Yuden) |
| | | | | 0.47 | 75 | LQM21PNR47MG0 (Murata) |
| | | | | | | |

Cautions in selecting external parts

- Choose a low ESR ceramic capacitor. The capacitance of C_{IN} between V_{IN} and GND should be more than or equal to 4.7 μF. The capacitance of a ceramic capacitor (C_{OUT}) should be 10 μF. Also, choose the capacitor with consideration for bias characteristics and input/output voltages. See the above tables of “Input Voltage vs. Capacitance” and “Set Output Voltage vs. Capacitance”.
- The phase compensation of this device is designed according to the C_{OUT} and L values. The inductance range of an inductor should be between 0.47μH to 0.56 μH in order to gain stability. See the above table of “Inductance Range vs. PWM Frequency”.
- Choose an inductor that has small DC resistance, has enough permissible current and is hard to cause magnetic saturation. If the inductance value of the inductor becomes extremely small under the load conditions, the peak current of LX may increase along with the load current. As a result, over current protection circuit may start to operate when the peak current of LX reaches to LX limit current. Therefore, choose an inductor with consideration for the value of I_{LXMAX} . See the following page of “Calculation Conditions of LX Pin Maximum Output Current (I_{LXMAX})”.
- As for the fixed output voltage type (RP509x00XC/D), Output Voltage (V_{SET}) is settable by changing values of R1 and R2. V_{SET} is given by the following expression.
- As for the adjustable output voltage type, the set output voltage (V_{SET}) is adjustable by changing the resistance values of resistors (R1, R2) as follows. See the following table for each recommended value of R1, R2 and C1.

$$V_{SET} = V_{FB} \times (R1 + R2) / R2$$

RP509x

NO.EA-362-160510

Set Output Voltage (V_{SET}) vs. R1 / R2 / C1 (Adjustable Output Voltage Type)

| V_{SET} [V] | R1 [k Ω] | R2 [k Ω] | C1 [pF] |
|-----------------------------|---|------------------|---------|
| 0.6 | 0 | 220 | Open |
| $0.6 < V_{SET} \leq 0.9$ | $R1 = (V_{SET} / V_{FB} - 1) \times R2$ | 220 | 47 |
| $0.9 < V_{SET} \leq 1.8$ | | 220 | 33 |
| $1.8 < V_{SET} \leq 2.1$ | | 150 | 10 |
| $2.1 < V_{SET} \leq 2.4$ | | 100 | 10 |
| $2.4 < V_{SET} \leq 2.7$ | | 68 | 10 |
| $2.7 < V_{SET} \leq 3.0$ | | 47 | 10 |
| $3.0 < V_{SET} \leq V_{IN}$ | | 47 | 6.8 |

Calculation Conditions of LX Pin Maximum Output Current (I_{LXMAX})

The following equations explain the relationship to determine I_{LXMAX} at the ideal operation of the ICs in continuous mode.

Ripple Current P-P value is described as I_{RP} , ON resistance of Pch. Tr. is described as R_{ONP} , ON resistance of Nch. Tr. is described as R_{ONN} , and DC resistor of the inductor is described as R_L .

First, when Pch. Tr. is "ON", Equation 1 is satisfied.

$$V_{IN} = V_{OUT} + (R_{ONP} + R_L) \times I_{OUT} + L \times I_{RP} / t_{ON} \dots \dots \dots \text{Equation 1}$$

Second, when Pch. Tr. is "OFF" (Nch. Tr. is "ON"), Equation 2 is satisfied.

$$L \times I_{RP} / t_{OFF} = R_{ONN} \times I_{OUT} + V_{OUT} + R_L \times I_{OUT} \dots \dots \dots \text{Equation 2}$$

Put Equation 2 into Equation 1 to solve ON duty of Pch. Tr. ($D_{ON} = t_{ON} / (t_{OFF} + t_{ON})$):

$$D_{ON} = (V_{OUT} + R_{ONN} \times I_{OUT} + R_L \times I_{OUT}) / (V_{IN} + R_{ONN} \times I_{OUT} - R_{ONP} \times I_{OUT}) \dots \dots \dots \text{Equation 3}$$

Ripple Current is described as follows:

$$I_{RP} = (V_{IN} - V_{OUT} - R_{ONP} \times I_{OUT} - R_L \times I_{OUT}) \times D_{ON} / f_{OSC} / L \dots \dots \dots \text{Equation 4}$$

Peak current that flows through L, and LX Tr. is described as follows:

$$I_{LXMAX} = I_{OUT} + I_{RP} / 2 \dots \dots \dots \text{Equation 5}$$

TECHNICAL NOTES

The performance of power source circuits using this IC largely depends on peripheral circuits. When selecting the peripheral components, please consider the conditions of use. Do not allow each component, PCB pattern or the IC to exceed their respected rated values (voltage, current, and power) when designing the peripheral circuits.

- Set the external components as close as possible to the IC and minimize the wiring between the components and the IC. Especially, place a capacitor (C_{IN}) as close as possible to the VIN pin and GND.
- Ensure the VIN and GND lines are sufficiently robust. If their impedance is too high, noise pickup or unstable operation may result.
- The VIN line, the GND line, the VOUT line, an inductor, and LX should make special considerations for the large switching current flows.
- The wiring between the VOUT pin and an inductor (L) (RP509xxxXA/B) or between a resistor for setting output voltage (R1) and L (RP509x00XC/D) should be separated from the wiring between L and Load.
- Over current protection circuit may be affected by self-heating or power dissipation environment.
- In the case of the adjustable output voltage type, the input / output voltage ratio must become the following condition to achieve a high-efficiency with stable VFM mode at light load when the MODE pin is "L".

$$V_{OUT} / V_{IN} < 0.7$$

$V_{MODE} = "L"$ PWM/VFM Auto Switching

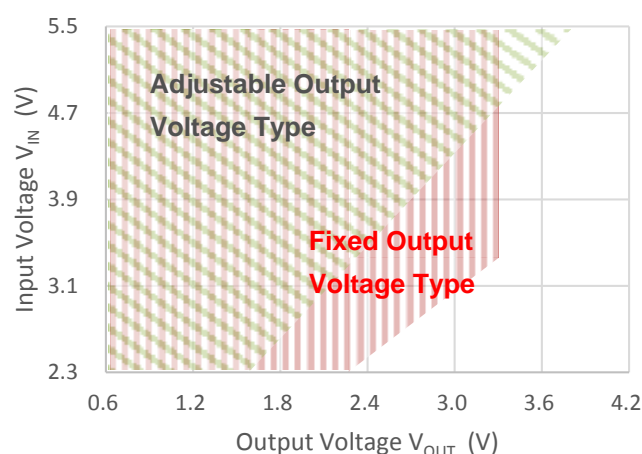

Available Voltage Area with Stable VFM Mode (Adjustable Output Voltage Type)

RP509x

NO.EA-362-160510

TYPICAL CHARACTERISTICS

Typical Characteristics in RP509Z are intended to be used as reference data, and they are not guaranteed.

1) Efficiency vs. Output Current

$V_{OUT} = 1.0\text{ V}$

$V_{MODE} = \text{"L" PWM/VFM Auto Switching}$

L = MIPSZ2012D0R5

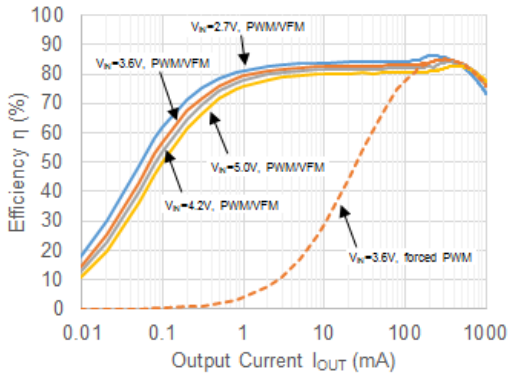

$V_{OUT} = 1.2\text{ V}$

$V_{MODE} = \text{"L" PWM/VFM Auto Switching}$

L = MIPSZ2012D0R5

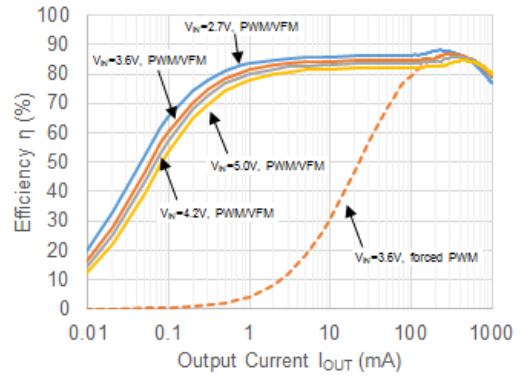

$V_{OUT} = 1.8\text{ V}$

$V_{MODE} = \text{"L" PWM/VFM Auto Switching}$

L = MIPSZ2012D0R5

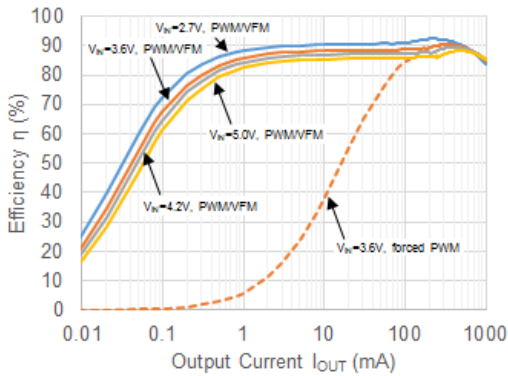

$V_{OUT} = 3.3\text{ V (Fixed Output Voltage Type)}$

$V_{MODE} = \text{"L" PWM/VFM Auto Switching}$

L = MIPSZ2012D0R5

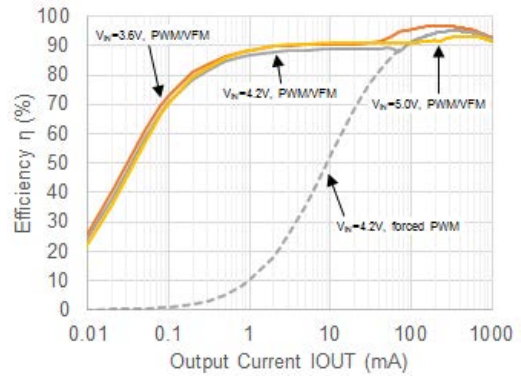

$V_{OUT} = 1.8\text{ V}$

$V_{MODE} = \text{"H" Forced PWM Mode}$

L = MIPSZ2012D0R5

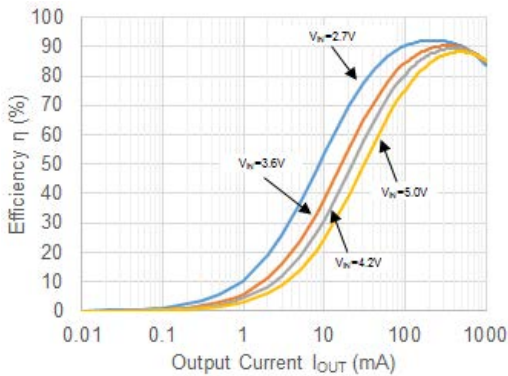

[Small Mount Solution]

$V_{OUT} = 1.0\text{ V}$
 $V_{MODE} = \text{"L" PWM/VFM Auto Switching}$
 $L = \text{MDT1608-CRR47M}$

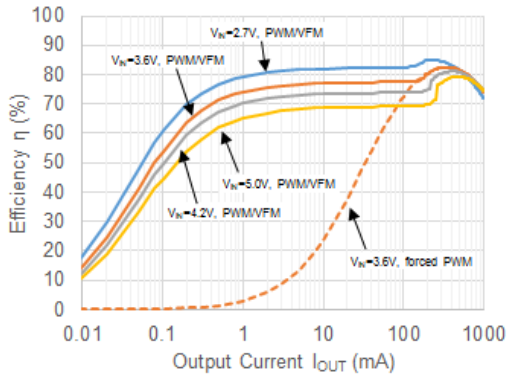

$V_{OUT} = 1.2\text{ V}$
 $V_{MODE} = \text{"L" PWM/VFM Auto Switching}$
 $L = \text{MDT1608-CRR47M}$

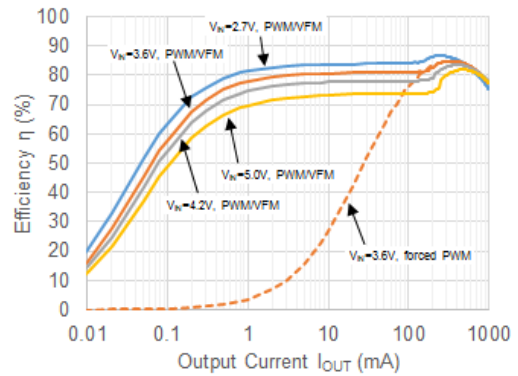

$V_{OUT} = 1.8\text{ V}$
 $V_{MODE} = \text{"L" PWM/VFM Auto Switching}$
 $L = \text{MDT1608-CRR47M}$

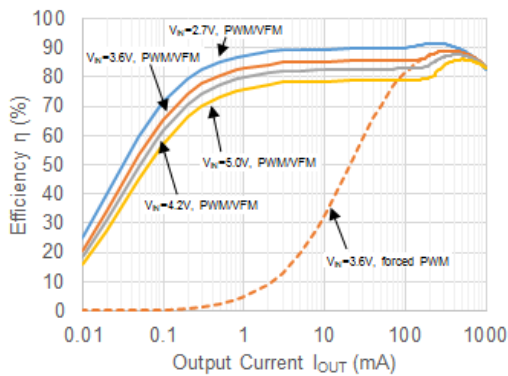

$V_{OUT} = 3.3\text{ V (Fixed Output Voltage Type)}$
 $V_{MODE} = \text{"L" PWM/VFM Auto Switching}$
 $L = \text{MDT1608-CRR47M}$

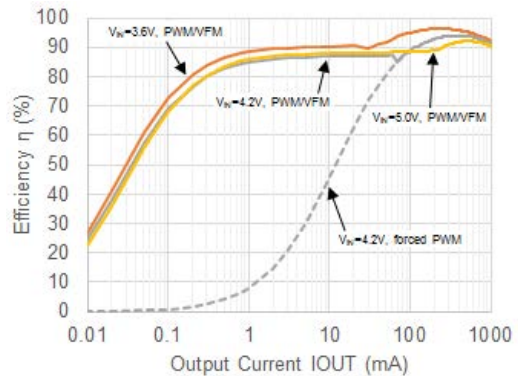

$V_{OUT} = 1.8\text{ V}$
 $V_{MODE} = \text{"H" Forced PWM Mode}$
 $L = \text{MDT1608-CRR47M}$

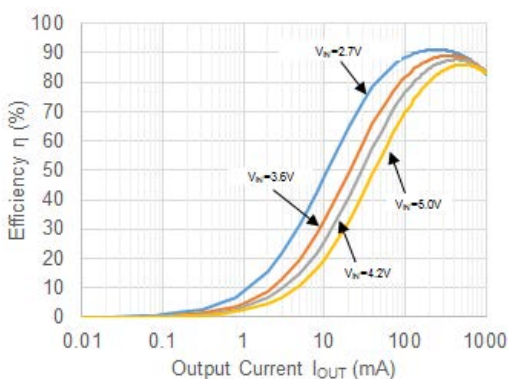

2) Output Voltage vs. Output Current

$V_{IN} = 3.6\text{ V}$, $V_{OUT} = 1.8\text{ V}$

$V_{MODE} = \text{"L"}$ PWM/VFM Auto Switching

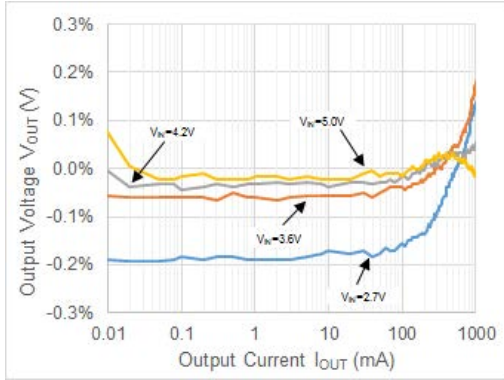

$V_{IN} = 3.6\text{ V}$, $V_{OUT} = 1.8\text{ V}$

$V_{MODE} = \text{"H"}$ Forced PWM Mode

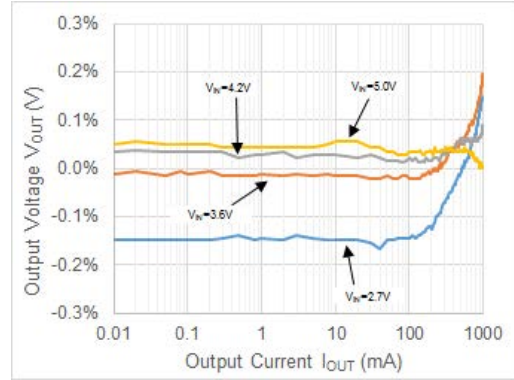

3) Oscillator Frequency vs. Input Voltage

$I_{OUT} = 1.0\text{ mA}$

$V_{MODE} = \text{"L"}$ PWM/VFM Auto Switching

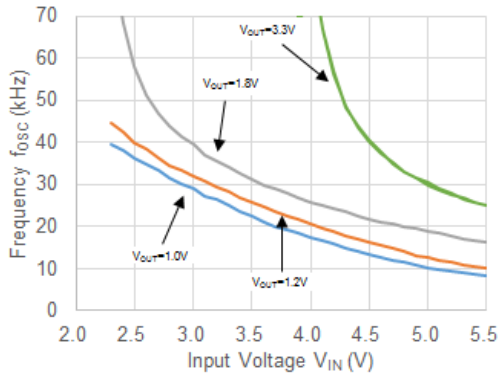

$I_{OUT} = 1.0\text{ mA}$

$V_{MODE} = \text{"H"}$ Forced PWM Mode

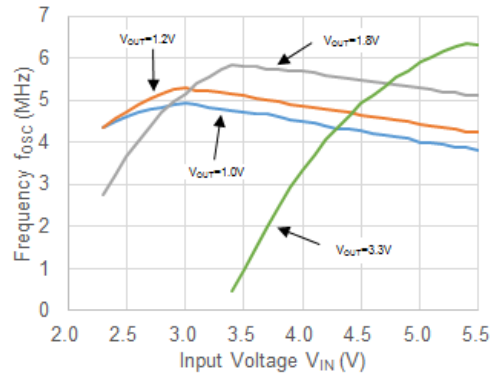

$I_{OUT} = 500\text{ mA}$

$V_{MODE} = \text{"H"}$ Forced PWM Mode

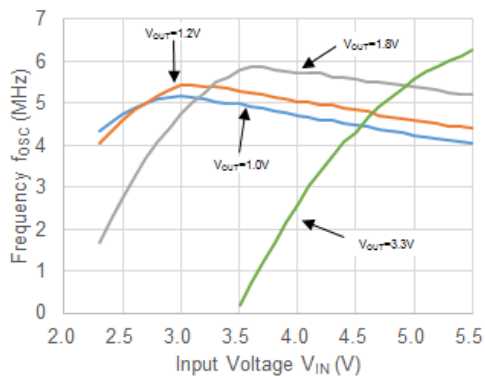

4) Load Transient Response Waveform

$V_{IN} = 3.6\text{ V}$, $V_{OUT} = 1.8\text{ V}$

$V_{MODE} = \text{"L"}$ PWM/VFM Auto Switching

$I_{OUT} = 1.0 \rightarrow 500\text{ mA}$

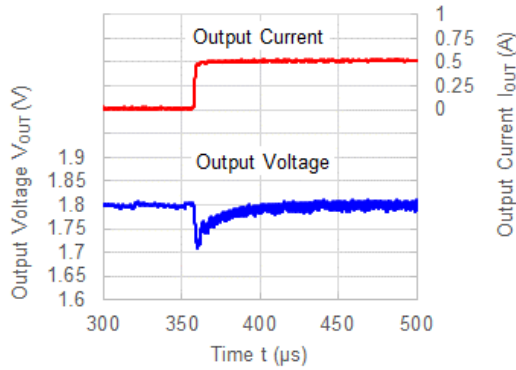

$V_{IN} = 3.6\text{ V}$, $V_{OUT} = 1.8\text{ V}$

$V_{MODE} = \text{"L"}$ PWM/VFM Auto Switching

$I_{OUT} = 500 \rightarrow 1.0\text{ mA}$

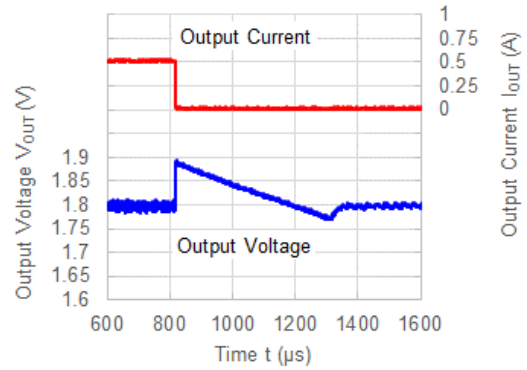

$V_{IN} = 3.6\text{ V}$, $V_{OUT} = 1.8\text{ V}$

$V_{MODE} = \text{"H"}$ Forced PWM Mode

$I_{OUT} = 1.0 \rightarrow 500\text{ mA}$

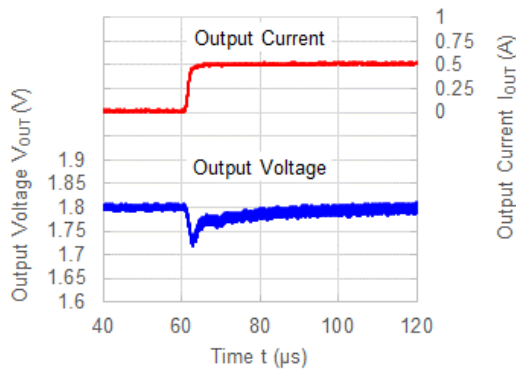

$V_{IN} = 3.6\text{ V}$, $V_{OUT} = 1.8\text{ V}$

$V_{MODE} = \text{"H"}$ Forced PWM Mode

$I_{OUT} = 500 \rightarrow 1.0\text{ mA}$

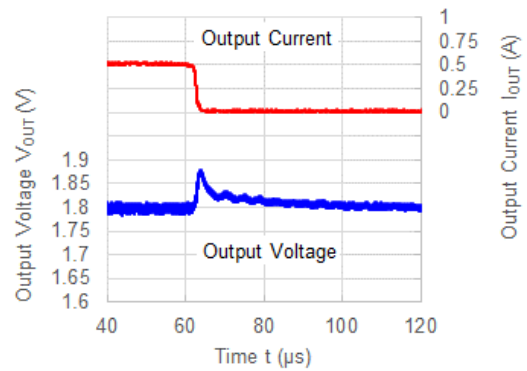

$V_{IN} = 3.6\text{ V}$, $V_{OUT} = 1.8\text{ V}$

$V_{MODE} = \text{"L"}$ PWM/VFM Auto Switching

$I_{OUT} = 300 \rightarrow 600\text{ mA}$

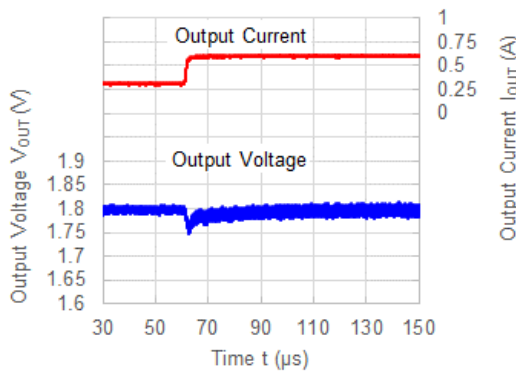

$V_{IN} = 3.6\text{ V}$, $V_{OUT} = 1.8\text{ V}$

$V_{MODE} = \text{"L"}$ PWM/VFM Auto Switching

$I_{OUT} = 600 \rightarrow 300\text{ mA}$

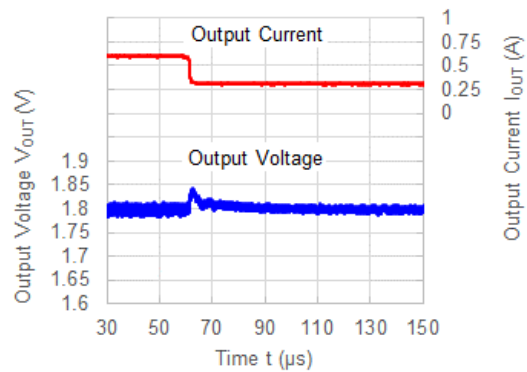

RP509x

NO.EA-362-160510

$V_{IN} = 3.6\text{ V}$, $V_{OUT} = 1.8\text{ V}$
 $V_{MODE} = \text{"H"}$ Forced PWM Mode
 $I_{OUT} = 300 \rightarrow 600\text{ mA}$

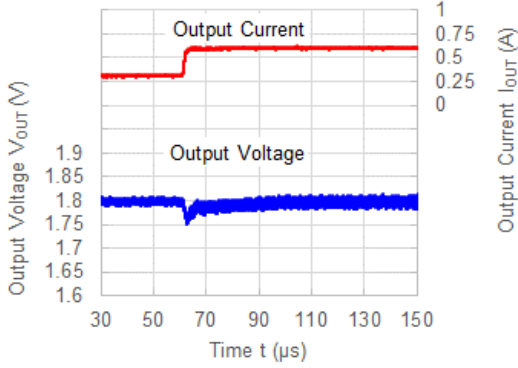

$V_{IN} = 3.6\text{ V}$, $V_{OUT} = 1.8\text{ V}$
 $V_{MODE} = \text{"H"}$ Forced PWM Mode
 $I_{OUT} = 600 \rightarrow 300\text{ mA}$

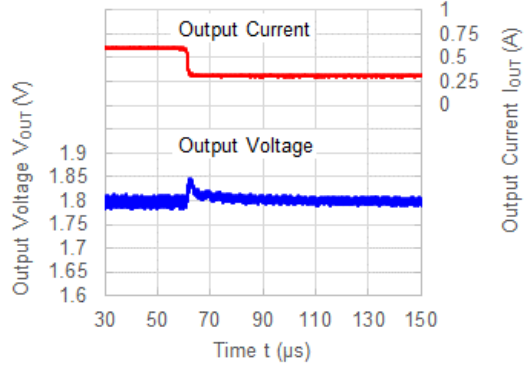

5) Mode Switching Waveform

$V_{IN} = 3.6\text{ V}$, $V_{OUT} = 1.8\text{ V}$
 $I_{OUT} = 1.0\text{ mA}$
 $V_{MODE} = \text{"L"} \rightarrow \text{"H"}$

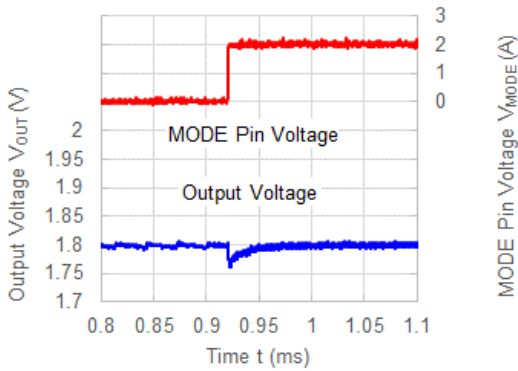

$V_{IN} = 3.6\text{ V}$, $V_{OUT} = 1.8\text{ V}$
 $I_{OUT} = 1.0\text{ mA}$
 $V_{MODE} = \text{"H"} \rightarrow \text{"L"}$

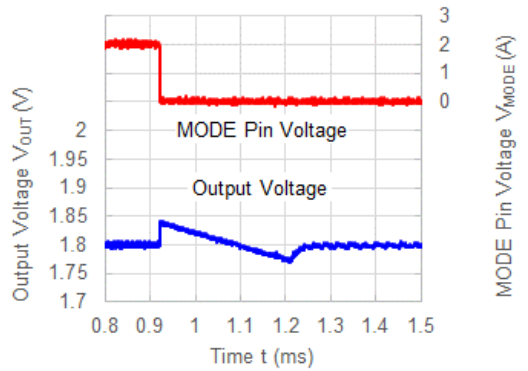

6) Output Voltage Waveform

$V_{IN} = 3.6\text{ V}$, $V_{OUT} = 1.8\text{ V}$
 $V_{MODE} = \text{"L"}$ PWM/VFM Auto Switching
 $I_{OUT} = 1.0\text{ mA}$

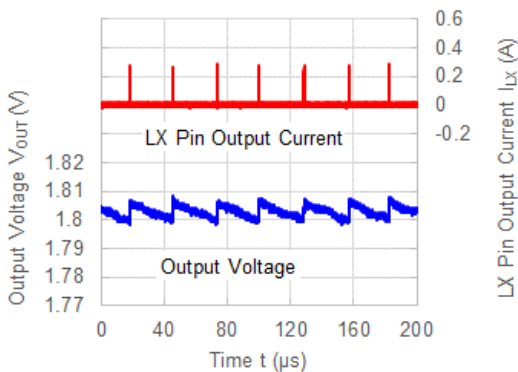

$V_{IN} = 3.6\text{ V}$, $V_{OUT} = 1.8\text{ V}$
 $V_{MODE} = \text{"H"}$ Forced PWM Mode
 $I_{OUT} = 1.0\text{ mA}$

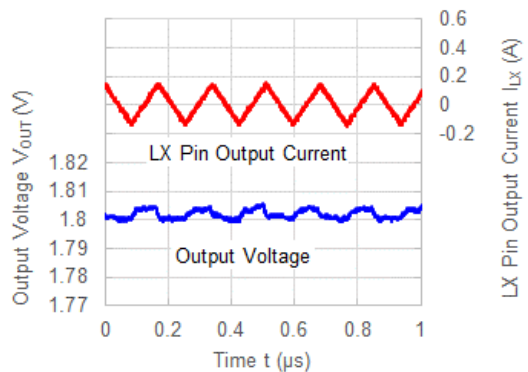

$V_{IN} = 3.6\text{ V}$, $V_{OUT} = 1.8\text{ V}$
 $V_{MODE} = \text{"L"}$ PWM/VFM Auto Switching
 $I_{OUT} = 500\text{ mA}$

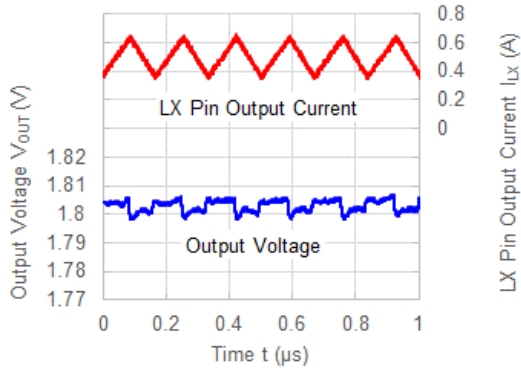

$V_{IN} = 3.6\text{ V}$, $V_{OUT} = 1.8\text{ V}$
 $V_{MODE} = \text{"H"}$ Forced PWM Mode
 $I_{OUT} = 500\text{ mA}$

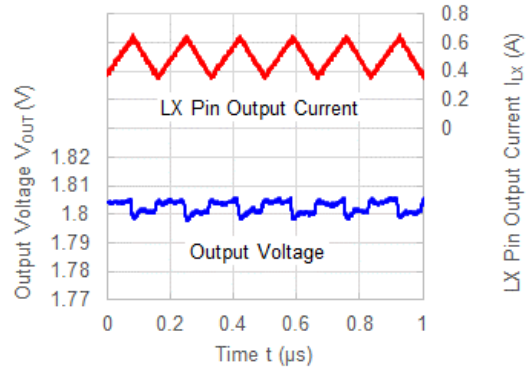

The power dissipation of the package is dependent on PCB material, layout, and environmental conditions. The following conditions are used in this measurement.

Measurement Conditions

| | |
|------------------|---|
| | JEDEC STD. 51-9 Test Land Pattern |
| Environment | Mounting on Board (Wind Velocity = 0 m/s) |
| Board Material | Glass Cloth Epoxy Plastic (Four-Layer Board) |
| Board Dimensions | 101.5 mm x 114.5 mm x 1.6 mm |
| Copper Ratio | Outer Layers (First and Fourth Layers): 60% Inner Layers (Second and Third Layers): 100% |

Measurement Result

(Ta = 25°C, Tjmax = 125°C)

| | |
|--------------------|--|
| | JEDEC STD. 51-9 Test Land Pattern |
| Power Dissipation | 910 mW |
| Thermal Resistance | $\theta_{ja} = (125 - 25^\circ\text{C}) / 0.91 \text{ W} = 109 \text{ }^\circ\text{C/W}$ |

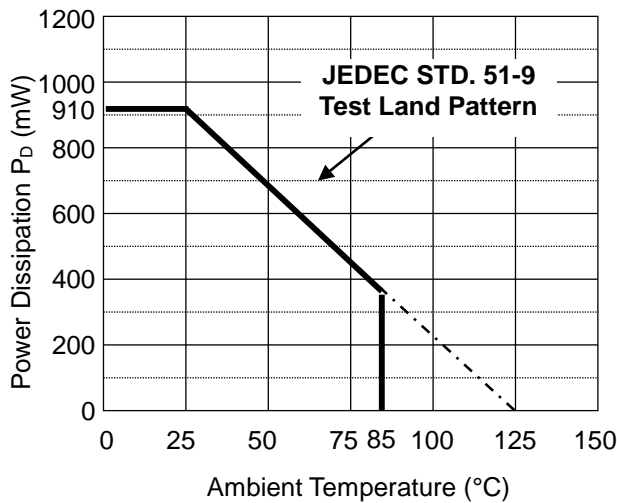

Power Dissipation vs. Ambient Temperature

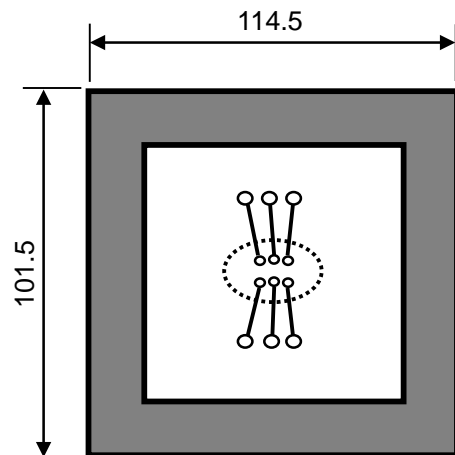

○ IC Mount Area (mm)

Measurement Board Pattern

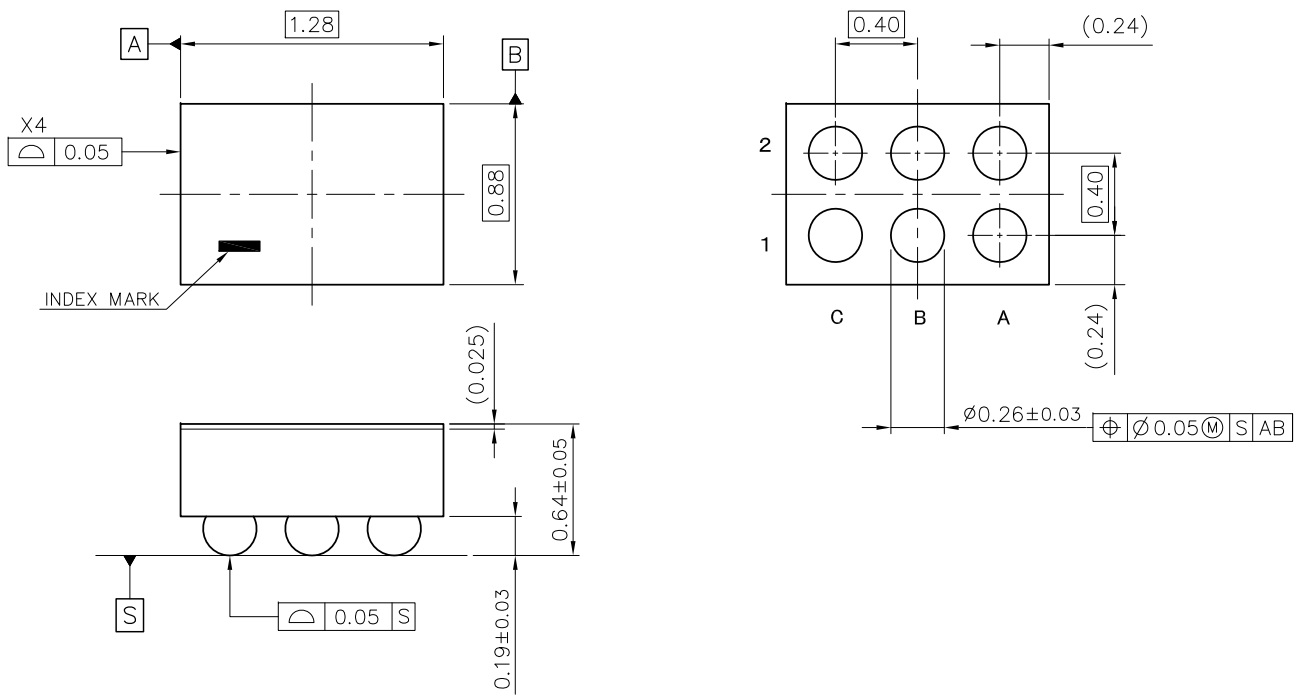

WLCSP-6-P6 Package Dimensions (Unit: mm)

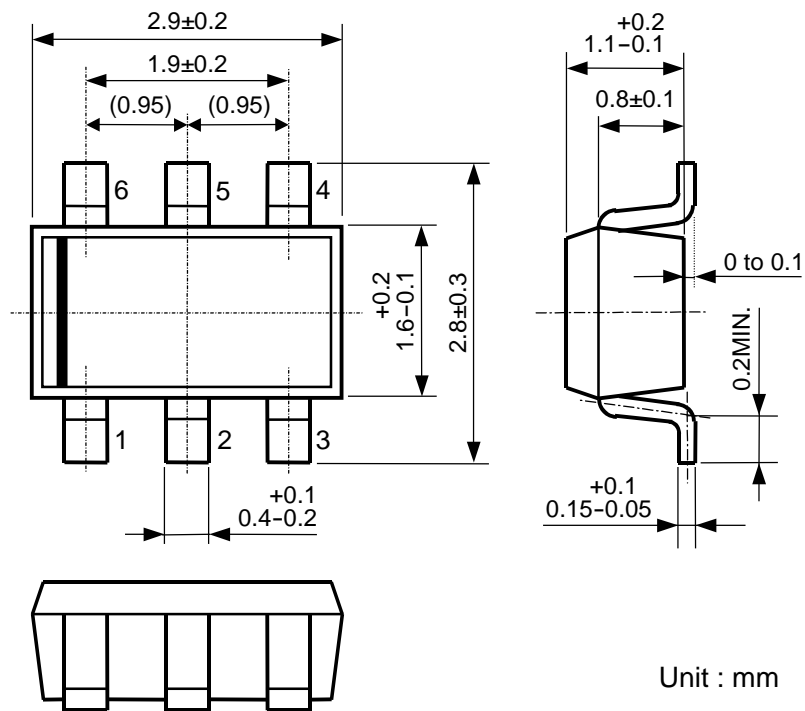

SOT-23-6 Package Dimensions (Unit: mm)



1. The products and the product specifications described in this document are subject to change or discontinuation of production without notice for reasons such as improvement. Therefore, before deciding to use the products, please refer to Ricoh sales representatives for the latest information thereon.
2. The materials in this document may not be copied or otherwise reproduced in whole or in part without prior written consent of Ricoh.
3. Please be sure to take any necessary formalities under relevant laws or regulations before exporting or otherwise taking out of your country the products or the technical information described herein.
4. The technical information described in this document shows typical characteristics of and example application circuits for the products. The release of such information is not to be construed as a warranty of or a grant of license under Ricoh's or any third party's intellectual property rights or any other rights.
5. The products listed in this document are intended and designed for use as general electronic components in standard applications (office equipment, telecommunication equipment, measuring instruments, consumer electronic products, amusement equipment etc.). Those customers intending to use a product in an application requiring extreme quality and reliability, for example, in a highly specific application where the failure or misoperation of the product could result in human injury or death (aircraft, spacevehicle, nuclear reactor control system, traffic control system, automotive and transportation equipment, combustion equipment, safety devices, life support system etc.) should first contact us.
6. We are making our continuous effort to improve the quality and reliability of our products, but semiconductor products are likely to fail with certain probability. In order to prevent any injury to persons or damages to property resulting from such failure, customers should be careful enough to incorporate safety measures in their design, such as redundancy feature, fire containment feature and fail-safe feature. We do not assume any liability or responsibility for any loss or damage arising from misuse or inappropriate use of the products.
7. Anti-radiation design is not implemented in the products described in this document.
8. Please contact Ricoh sales representatives should you have any questions or comments concerning the products or the technical information.



Ricoh is committed to reducing the environmental loading materials in electrical devices with a view to contributing to the protection of human health and the environment.

Ricoh has been providing RoHS compliant products since April 1, 2006 and Halogen-free products since April 1, 2012.

RICOH RICOH ELECTRONIC DEVICES CO., LTD.

<http://www.e-devices.ricoh.co.jp/en/>

Sales & Support Offices

RICOH ELECTRONIC DEVICES CO., LTD.

Higashi-Shinagawa Office (International Sales)
3-32-3, Higashi-Shinagawa, Shinagawa-ku, Tokyo 140-8655, Japan
Phone: +81-3-5479-2857 Fax: +81-3-5479-0502

RICOH EUROPE (NETHERLANDS) B.V.

Semiconductor Support Centre
Prof. W.H. Keesomlaan 1, 1183 DJ Amstelveen, The Netherlands
Phone: +31-20-5474-309

RICOH INTERNATIONAL B.V. - German Branch

Semiconductor Sales and Support Centre
Oberrather Strasse 6, 40472 Düsseldorf, Germany
Phone: +49-211-6546-0

RICOH ELECTRONIC DEVICES KOREA CO., LTD.

3F, Haesung Bldg, 504, Teheran-ro, Gangnam-gu, Seoul, 135-725, Korea
Phone: +82-2-2135-5700 Fax: +82-2-2051-5713

RICOH ELECTRONIC DEVICES SHANGHAI CO., LTD.

Room 403, No.2 Building, No.690 Bibo Road, Pu Dong New District, Shanghai 201203, People's Republic of China
Phone: +86-21-5027-3200 Fax: +86-21-5027-3299

RICOH ELECTRONIC DEVICES CO., LTD.

Taipei office
Room 109, 10F-1, No.51, Hengyang Rd., Taipei City, Taiwan (R.O.C.)
Phone: +886-2-2313-1621/1622 Fax: +886-2-2313-1623

Mouser Electronics

Authorized Distributor

Click to View Pricing, Inventory, Delivery & Lifecycle Information:

[Ricoch Electronics:](#)

[RP509Z002D-E2-F](#) [RP509Z202B-E2-F](#) [RP509Z121B-E2-F](#)



Компания «ЭлектроПласт» предлагает заключение долгосрочных отношений при поставках импортных электронных компонентов на взаимовыгодных условиях!

Наши преимущества:

- Оперативные поставки широкого спектра электронных компонентов отечественного и импортного производства напрямую от производителей и с крупнейших мировых складов;
- Поставка более 17-ти миллионов наименований электронных компонентов;
- Поставка сложных, дефицитных, либо снятых с производства позиций;
- Оперативные сроки поставки под заказ (от 5 рабочих дней);
- Экспресс доставка в любую точку России;
- Техническая поддержка проекта, помощь в подборе аналогов, поставка прототипов;
- Система менеджмента качества сертифицирована по Международному стандарту ISO 9001;
- Лицензия ФСБ на осуществление работ с использованием сведений, составляющих государственную тайну;
- Поставка специализированных компонентов (Xilinx, Altera, Analog Devices, Intersil, Interpoint, Microsemi, Aeroflex, Peregrine, Syfer, Eurofarad, Texas Instrument, Miteq, Cobham, E2V, MA-COM, Hittite, Mini-Circuits, General Dynamics и др.);

Помимо этого, одним из направлений компании «ЭлектроПласт» является направление «Источники питания». Мы предлагаем Вам помощь Конструкторского отдела:

- Подбор оптимального решения, техническое обоснование при выборе компонента;
- Подбор аналогов;
- Консультации по применению компонента;
- Поставка образцов и прототипов;
- Техническая поддержка проекта;
- Защита от снятия компонента с производства.



Как с нами связаться

Телефон: 8 (812) 309 58 32 (многоканальный)

Факс: 8 (812) 320-02-42

Электронная почта: org@eplast1.ru

Адрес: 198099, г. Санкт-Петербург, ул. Калинина, дом 2, корпус 4, литера А.