

Operational Amplifiers / Comparators

# Ultra Low Power CMOS Operational Amplifiers



BU7265G, BU7265SG, BU7205HFV, BU7205SHFV, BU7271G, BU7271SG,  
BU7245HFV, BU7245SHFV, BU7411G, BU7411SG, BU7421G, BU7421SG,  
BU7475HFV, BU7475SHFV

No.10049EAT19

## ●Description

Ultra Low Power CMOS Op-Amp BU7265/BU7205/BU7271/BU7245 family (Input-Output Full Swing) and BU7411 / BU7421 / BU7475 (ground sense) are monolithic IC. Supply current is very small (BU7265/BU7411 family: 0.35[μA], BU7421 family: 8.5[μA], BU7271 family: 8.6[μA]), and VDD range is +1.6[V] ~ +5.5[V] (BU7411 family: single supply), so operable with low voltage. It's suitable for applications of portable equipments and battery movements.

## ●Features

- 1) Ultra Low Power  
0.35[μA] : BU7265 family  
          : BU7411 family  
8.5[μA] : BU7421 family  
8.6[μA] : BU7271 family
- 2) High large signal voltage gain
- 3) Wide temperature range  
-40[°C] ~ +85[°C]  
(BU7265G, BU7271G, BU7411G, BU7421G)  
(BU7205HFV, BU7245HFV, BU7475HFV)  
-40[°C] ~ +105[°C]  
(BU7265SG, BU7271SG, BU7411SG, BU7421SG)  
(BU7205SHFV, BU7245SHFV, BU7475SHFV)
- 4) Low input bias current 1[pA] (Typ.)
- 5) Internal ESD protection  
Human body model (HBM) ±4000 [V] (Typ.)
- 6) Internal phase compensation
- 7) Low operating supply voltage  
+1.8[V] ~ +5.5[V] (single supply)  
(BU7265 family, BU7271 family)  
(BU7205 family, BU7245 family)  
+1.7[V] ~ +5.5[V] (single supply)  
(BU7421 family, BU7475 family)  
+1.6[V] ~ +5.5[V] (single supply)  
(BU7411 family)

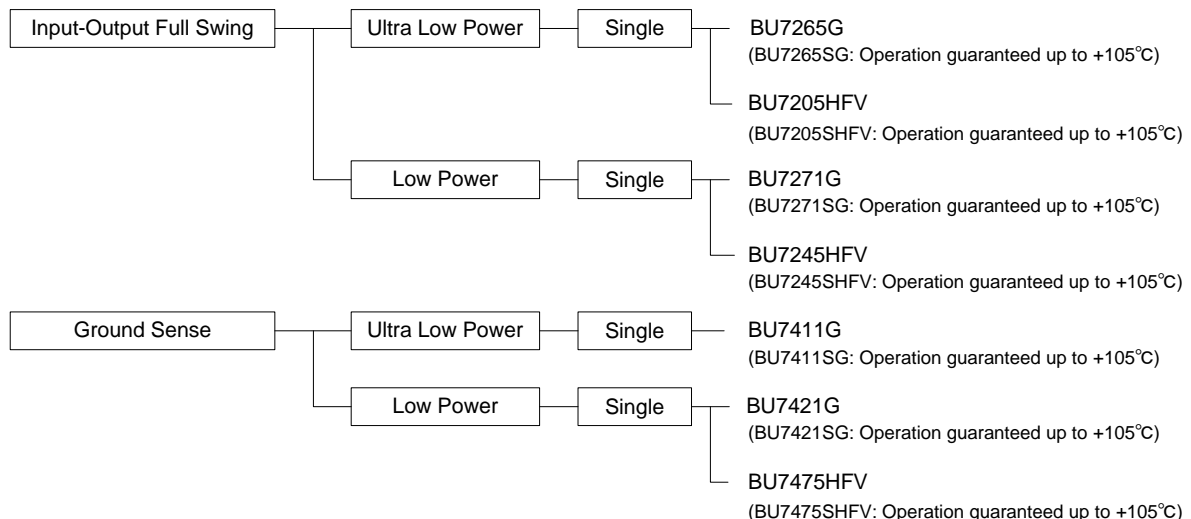

● Pin Assignments

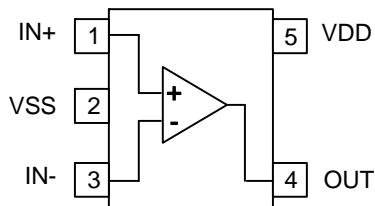

**SSOP5**      **HVSOF5**

Input type	Package		Input type	Package	
	SSOP5	HVSOF5		SSOP5	HVSOF5
Input-Output Full Swing	BU7265G BU7265SG BU7271G BU7271SG	BU7205HFV BU7205SHFV BU7245HFV BU7245SHFV	Ground Sense	BU7411G BU7411SG BU7421G BU7421SG	BU7475HFV BU7475SHFV

● Absolute Maximum Ratings (Ta=25[°C])

Parameter	Symbol	Ratings		Unit
		BU7265G, BU7411G BU7271G, BU7421G BU7205HFV, BU7245HFV BU7475HFV	BU7265SG, BU7411SG BU7271SG, BU7421SG BU7205SHFV, BU7245SHFV BU7475SHFV	
Supply Voltage	VDD-VSS	+7		V
Differential Input Voltage (*1)	Vid	VDD-VSS		V
Input Common-mode Voltage Range	Vicm	(VSS-0.3) ~ VDD+0.3		V
Operating Temperature	Topr	-40 ~ +85	-40 ~ +105	°C
Storage Temperature	Tstg	-55 ~ +125		°C
Maximum Junction Temperature	Tjmax	+125		°C

Note: Absolute maximum rating item indicates the condition which must not be exceeded. Application of voltage in excess of absolute maximum rating or use out absolute maximum rated temperature environment may cause deterioration of characteristics.

(\*1) The voltage difference between inverting input and non-inverting input is the differential input voltage. Then input terminal voltage is set to more than VSS.

●Electrical characteristics: Input-Output Full Swing

OBU7265 family (Unless otherwise specified VDD=+3[V], VSS=0[V], Ta=25[°C])

Parameter	Symbol	Temperature Range	Limits			Unit	Condition
			BU7265G, BU7265SG				
			Min.	Typ.	Max.		
Input Offset Voltage <sup>(*2)</sup>	Vio	25°C	-	1	8.5	mV	VDD=1.8 ~ 5.5[V], VOUT=VDD/2
Input Offset Current <sup>(*2)</sup>	Iio	25°C	-	1	-	pA	—
Input Bias Current <sup>(*2)</sup>	Ib	25°C	-	1	-	pA	—
Supply Current <sup>(*3)</sup>	IDD	25°C	-	0.35	0.9	μA	RL=∞, AV=0[dB], VIN=1.5[V]
		Full range	-	-	1.3		
High Level Output Voltage	VOH	25°C	VDD-0.1	-	-	V	RL=10[kΩ]
Low Level Output Voltage	VOL	25°C	-	-	VSS+0.1	V	RL=10[kΩ]
Large Signal Voltage Gain	AV	25°C	60	95	-	dB	RL=10[kΩ]
Input Common-mode Voltage Range	Vicm	25°C	0	-	3	V	VDD-VSS=3[V]
Common-mode Rejection Ratio	CMRR	25°C	45	60	-	dB	—
Power Supply Rejection Ratio	PSRR	25°C	60	80	-	dB	—
Output Source Current <sup>(*4)</sup>	IOH	25°C	1	2.4	-	mA	VDD-0.4[V]
Output Sink Current <sup>(*4)</sup>	IOL	25°C	2	4	-	mA	VSS+0.4[V]
Slew Rate	SR	25°C	-	2.4	-	V/ms	CL=25[pF]
Gain Band width	FT	25°C	-	4	-	kHz	CL=25[pF], AV=40[dB]
Phase Margin	θ	25°C	-	60	-	°	CL=25[pF], AV=40[dB]

(\*2) Absolute value

(\*3) Full range BU7265: Ta=-40[°C]~+85[°C] BU7265S: Ta=-40[°C]~+105[°C]

(\*4) Under the high temperature environment, consider the power dissipation of IC when selecting the output current.

When the terminal short circuits are continuously output, the output current is reduced to climb to the temperature inside IC.

OBU7271 family (Unless otherwise specified VDD=+3[V], VSS=0[V], Ta=25[°C])

Parameter	Symbol	Temperature Range	Limits			Unit	Condition
			BU7271G, BU7271SG				
			Min.	Typ.	Max.		
Input Offset Voltage <sup>(*5)</sup>	Vio	25°C	-	1	8	mV	VDD=1.8 ~ 5.5[V], VOUT=VDD/2
Input Offset Current <sup>(*5)</sup>	Iio	25°C	-	1	-	pA	—
Input Bias Current <sup>(*5)</sup>	Ib	25°C	-	1	-	pA	—
Supply Current <sup>(*6)</sup>	IDD	25°C	-	8.6	17	μA	RL=∞, AV=0[dB], VIN=1.5[V]
		Full range	-	-	25		
High Level Output Voltage	VOH	25°C	VDD-0.1	-	-	V	RL=10[kΩ]
Low Level Output Voltage	VOL	25°C	-	-	VSS+0.1	V	RL=10[kΩ]
Large Signal Voltage Gain	AV	25°C	70	100	-	dB	RL=10[kΩ]
Input Common-mode Voltage Range	Vicm	25°C	0	-	3	V	VDD-VSS=3[V]
Common-mode Rejection Ratio	CMRR	25°C	45	60	-	dB	—
Power Supply Rejection Ratio	PSRR	25°C	60	80	-	dB	—
Output Source Current <sup>(*7)</sup>	IOH	25°C	2	4	-	mA	VDD-0.4[V]
Output Sink Current <sup>(*7)</sup>	IOL	25°C	4	8	-	mA	VSS+0.4[V]
Slew Rate	SR	25°C	-	50	-	V/ms	CL=25[pF]
Gain Band width	FT	25°C	-	90	-	kHz	CL=25[pF], AV=40[dB]
Phase Margin	θ	25°C	-	60	-	°	CL=25[pF], AV=40[dB]

(\*5) Absolute value

(\*6) Full range BU7271: Ta=-40[°C]~+85[°C] BU7271S: Ta=-40[°C]~+105[°C]

(\*7) Under the high temperature environment, consider the power dissipation of IC when selecting the output current.

When the terminal short circuits are continuously output, the output current is reduced to climb to the temperature inside IC.

OBU7205 family, (Unless otherwise specified VDD=+3[V], VSS=0[V], Ta=25[°C])

Parameter	Symbol	Temperature Range	Limits			Unit	Condition
			BU7205HFV, BU7205SHFV				
			Min.	Typ.	Max.		
Input Offset Voltage <sup>(*8)</sup>	Vio	25°C	-	1	9.5	mV	VDD=1.8 ~ 5.5[V], VOUT=VDD/2
Input Offset Current <sup>(*8)</sup>	Iio	25°C	-	1	-	pA	—
Input Bias Current <sup>(*8)</sup>	Ib	25°C	-	1	-	pA	—
Supply Current <sup>(*9)</sup>	IDD	25°C	-	0.4	0.95	µA	RL=∞, AV=0[dB], VIN=1.5[V]
		Full range	-	-	1.2		
High Level Output Voltage	VOH	25°C	VDD-0.1	-	-	V	RL=10[kΩ]
Low Level Output Voltage	VOL	25°C	-	-	VSS+0.1	V	RL=10[kΩ]
Large Signal Voltage Gain	AV	25°C	60	95	-	dB	RL=10[kΩ]
Input Common-mode Voltage Range	Vicm	25°C	0	-	3	V	VDD-VSS=3[V]
Common-mode Rejection Ratio	CMRR	25°C	45	60	-	dB	—
Power Supply Rejection Ratio	PSRR	25°C	60	80	-	dB	—
Output Source Current <sup>(*10)</sup>	IOH	25°C	0.5	1.2	-	mA	VDD-0.4[V]
Output Sink Current <sup>(*10)</sup>	IOL	25°C	1	2	-	mA	VSS+0.4[V]
Slew Rate	SR	25°C	-	2.5	-	V/ms	CL=25[pF]
Gain Band width	FT	25°C	-	2.5	-	kHz	CL=25[pF], AV=40[dB]
Phase Margin	θ	25°C	-	60	-	°	CL=25[pF], AV=40[dB]

(\*8) Absolute value

(\*9) Full range BU7205: Ta=-40[°C]~+85[°C] BU7205S: Ta=-40[°C]~+105[°C]

(\*10) Under the high temperature environment, consider the power dissipation of IC when selecting the output current.

When the terminal short circuits are continuously output, the output current is reduced to climb to the temperature inside IC.

OBU7245 family (Unless otherwise specified VDD=+3[V], VSS=0[V], Ta=25[°C])

Parameter	Symbol	Temperature Range	Limits			Unit	Condition
			BU7245HFV, BU7245SHFV				
			Min.	Typ.	Max.		
Input Offset Voltage <sup>(*11)</sup>	Vio	25°C	-	1	8.5	mV	VDD=1.8 ~ 5.5[V], VOUT=VDD/2
Input Offset Current <sup>(*11)</sup>	Iio	25°C	-	1	-	pA	—
Input Bias Current <sup>(*11)</sup>	Ib	25°C	-	1	-	pA	—
Supply Current <sup>(*12)</sup>	IDD	25°C	-	5.0	12	µA	RL=∞, AV=0[dB], VIN=1.5[V]
		Full range	-	-	20		
High Level Output Voltage	VOH	25°C	VDD-0.1	-	-	V	RL=10[kΩ]
Low Level Output Voltage	VOL	25°C	-	-	VSS+0.1	V	RL=10[kΩ]
Large Signal Voltage Gain	AV	25°C	60	95	-	dB	RL=10[kΩ]
Input Common-mode Voltage Range	Vicm	25°C	0	-	3	V	VDD-VSS=3[V]
Common-mode Rejection Ratio	CMRR	25°C	45	60	-	dB	—
Power Supply Rejection Ratio	PSRR	25°C	60	80	-	dB	—
Output Source Current <sup>(*13)</sup>	IOH	25°C	2	4	-	mA	VDD-0.4[V]
Output Sink Current <sup>(*13)</sup>	IOL	25°C	4	8	-	mA	VSS+0.4[V]
Slew Rate	SR	25°C	-	35	-	V/ms	CL=25[pF]
Gain Band width	FT	25°C	-	70	-	kHz	CL=25[pF], AV=40[dB]
Phase Margin	θ	25°C	-	60	-	°	CL=25[pF], AV=40[dB]

(\*11) Absolute value

(\*12) Full range BU7245: Ta=-40[°C]~+85[°C] BU7245S: Ta=-40[°C]~+105[°C]

(\*13) Under the high temperature environment, consider the power dissipation of IC when selecting the output current.

When the terminal short circuits are continuously output, the output current is reduced to climb to the temperature inside IC.

●Electrical characteristics: Ground Sense

OBU7411 family, (Unless otherwise specified VDD=+3[V], VSS=0[V], Ta=25[°C])

Parameter	Symbol	Temperature Range	Limits			Unit	Condition
			BU7411G, BU7411SG				
			Min.	Typ.	Max.		
Input Offset Voltage <sup>(*14)</sup>	Vio	25°C	-	1	8	mV	VDD=1.6 ~ 5.5[V], VOUT=VDD/2
Input Offset Current <sup>(*14)</sup>	Iio	25°C	-	1	-	pA	—
Input Bias Current <sup>(*14)</sup>	Ib	25°C	-	1	-	pA	—
Supply Current <sup>(*15)</sup>	IDD	25°C	-	0.35	0.8	µA	RL=∞, AV=0[dB], VIN=1.0[V]
		Full range	-	-	1.3		
High Level Output Voltage	VOH	25°C	VDD-0.1	-	-	V	RL=10[kΩ]
Low Level Output Voltage	VOL	25°C	-	-	VSS+0.1	V	RL=10[kΩ]
Large Signal Voltage Gain	AV	25°C	60	95	-	dB	RL=10[kΩ]
Input Common-mode Voltage Range	Vicm	25°C	0	-	2	V	VSS ~ VDD-1.0[V]
Common-mode Rejection Ratio	CMRR	25°C	45	60	-	dB	—
Power Supply Rejection Ratio	PSRR	25°C	60	80	-	dB	—
Output Source Current <sup>(*16)</sup>	IOH	25°C	1	2.4	-	mA	VDD-0.4[V]
Output Sink Current <sup>(*16)</sup>	IOL	25°C	2	4	-	mA	VSS+0.4[V]
Slew Rate	SR	25°C	-	2.4	-	V/ms	CL=25[pF]
Gain Band width	FT	25°C	-	4	-	kHz	CL=25[pF], AV=40[dB]
Phase Margin	θ	25°C	-	60	-	°	CL=25[pF], AV=40[dB]

(\*14) Absolute value

(\*15) Full range BU7411: Ta=-40[°C]~+85[°C] BU7411S: Ta=-40[°C]~+105[°C]

(\*16) Under the high temperature environment, consider the power dissipation of IC when selecting the output current.

When the terminal short circuits are continuously output, the output current is reduced to climb to the temperature inside IC.

OBU7421 family (Unless otherwise specified VDD=+3[V], VSS=0[V], Ta=25[°C])

Parameter	Symbol	Temperature Range	Limits			Unit	Condition
			BU7421G, BU7421SG				
			Min.	Typ.	Max.		
Input Offset Voltage <sup>(*17)</sup>	Vio	25°C	-	1	6	mV	VDD=1.7 ~ 5.5[V], VOUT=VDD/2
Input Offset Current <sup>(*17)</sup>	Iio	25°C	-	1	-	pA	—
Input Bias Current <sup>(*17)</sup>	Ib	25°C	-	1	-	pA	—
Supply Current <sup>(*18)</sup>	IDD	25°C	-	8.5	17	µA	RL=∞, AV=0[dB], VIN=0.9[V]
		Full range	-	-	25		
High Level Output Voltage	VOH	25°C	VDD-0.1	-	-	V	RL=10[kΩ]
Low Level Output Voltage	VOL	25°C	-	-	VSS+0.1	V	RL=10[kΩ]
Large Signal Voltage Gain	AV	25°C	70	100	-	dB	RL=10[kΩ]
Input Common-mode Voltage Range	Vicm	25°C	0	-	1.8	V	VSS ~ VDD-1.2[V]
Common-mode Rejection Ratio	CMRR	25°C	45	60	-	dB	—
Power Supply Rejection Ratio	PSRR	25°C	60	80	-	dB	—
Output Source Current <sup>(*19)</sup>	IOH	25°C	2	4	-	mA	VDD-0.4[V]
Output Sink Current <sup>(*19)</sup>	IOL	25°C	4	8	-	mA	VSS+0.4[V]
Slew Rate	SR	25°C	-	50	-	V/ms	CL=25[pF]
Gain Band width	FT	25°C	-	90	-	kHz	CL=25[pF], AV=40[dB]
Phase Margin	θ	25°C	-	60	-	°	CL=25[pF], AV=40[dB]

(\*17) Absolute value

(\*18) Full range BU7421: Ta=-40[°C]~+85[°C] BU7421S: Ta=-40[°C]~+105[°C]

(\*19) Under the high temperature environment, consider the power dissipation of IC when selecting the output current.

When the terminal short circuits are continuously output, the output current is reduced to climb to the temperature inside IC.

OBU7475 family(Unless otherwise specified VDD=+3[V], VSS=0[V], Ta=25[°C])

Parameter	Symbol	Temperature Range	Limits			Unit	Condition
			BU7475HFV,BU7475SHFV				
			Min.	Typ.	Max.		
Input Offset Voltage <sup>(*20)</sup>	Vio	25°C	-	1	6.5	mV	VDD=1.7 ~ 5.5[V], VOUT=VDD/2
Input Offset Current <sup>(*20)</sup>	Iio	25°C	-	1	-	pA	-
Input Ias Current <sup>(*20)</sup>	Ib	25°C	-	1	-	pA	-
Supply Current <sup>(*21)</sup>	IDD	25°C	-	9	18	µA	RL=∞, AV=0[dB] VIN=0.9[V]
		Full range	-	-	28		
High Level Output Voltage	VOH	25°C	VDD-0.1	-	-	V	RL=10[kΩ]
Low Level Output Voltage	VOL	25°C	-	-	VSS+0.1	V	RL=10[kΩ]
Large Signal Voltage Gain	AV	25°C	60	100	-	dB	RL=10[kΩ]
Input Common-mode Voltage Range	Vicm	25°C	0	-	1.8	V	VSS~VDD-1.2[V]
Common-mode Rejection Ratio	CMRR	25°C	45	60	-	dB	-
Power Supply Rejection Ratio	PSRR	25°C	60	80	-	dB	-
Output Source Current <sup>(*22)</sup>	IOH	25°C	4	7	-	mA	VDD-0.4[V]
Output Sink Current <sup>(*22)</sup>	IOL	25°C	9	14	-	mA	VSS+0.4[V]
Slew Rate	SR	25°C	-	50	-	V/ms	CL=25[pF]
Gain Band width	FT	25°C	-	100	-	kHz	CL=25[pF], AV=40[dB]
Phase Margin	θ	25°C	-	60	-	°	CL=25[pF], AV=40[dB]

(\*20) Absolute value

(\*21) Full range BU7475: Ta=-40[°C]~+85[°C] BU7475S: Ta=-40[°C]~+105[°C]

(\*22) Under the high temperature environment, consider the power dissipation of IC when selecting the output current.

When the terminal short circuits are continuously output, the output current is reduced to climb to the temperature inside IC.

●Reference Data

OBU7265 family

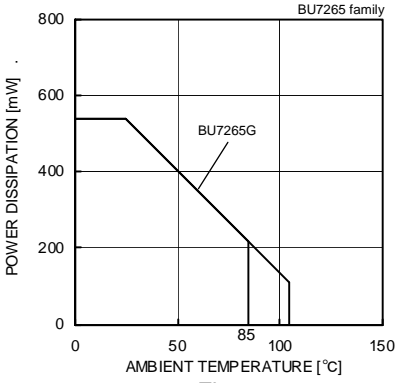

Fig.1

Derating curve

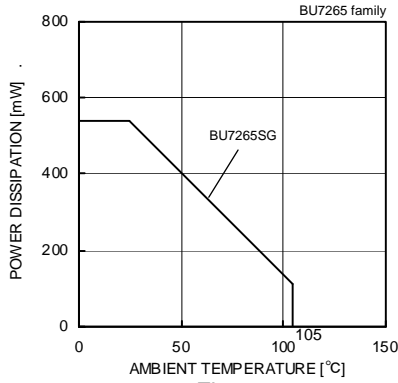

Fig.2

Derating curve

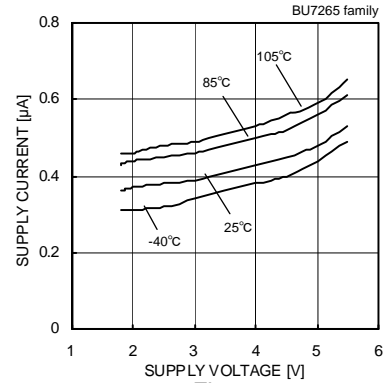

Fig.3

Supply Current - Supply Voltage

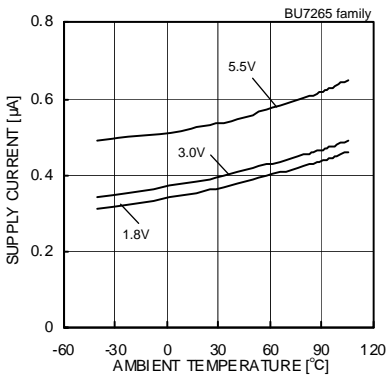

Fig.4

Supply Current - Ambient Temperature

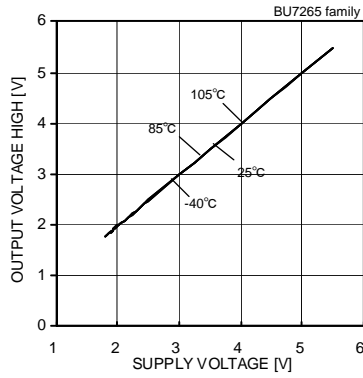

Fig.5

Output Voltage High - Supply Voltage (RL=10[kΩ])

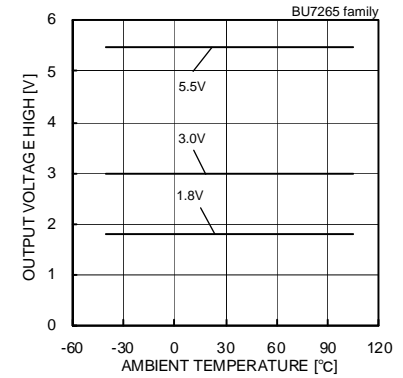

Fig.6

Output Voltage High - Ambient Temperature (RL=10[kΩ])

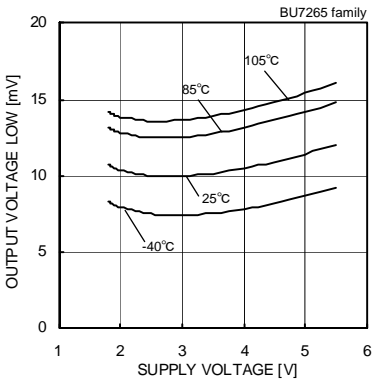

Fig.7

Output Voltage Low - Supply Voltage (RL=10[kΩ])

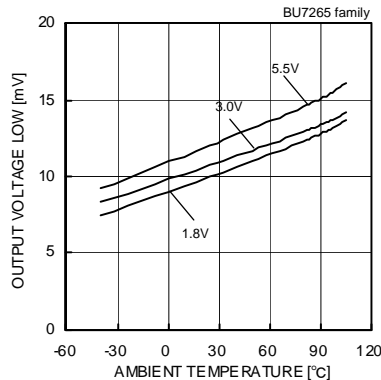

Fig.8

Output Voltage Low - Ambient Temperature (RL=10[kΩ])

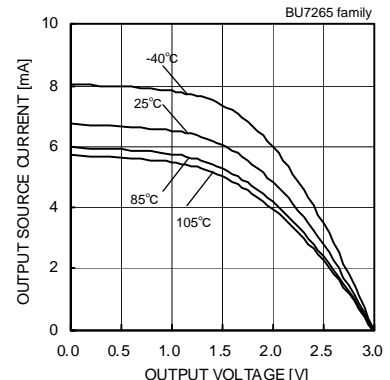

Fig.9

Output Source Current - Output Voltage (VDD=3[V])

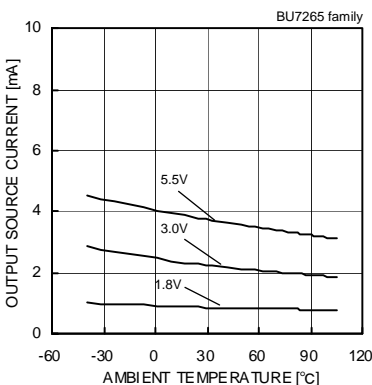

Fig.10

Output Source Current - Ambient Temperature (VOUT=VDD-0.4[V])

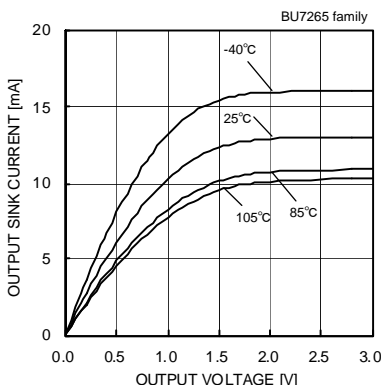

Fig.11

Output Sink Current - Output Voltage (VDD=3[V])

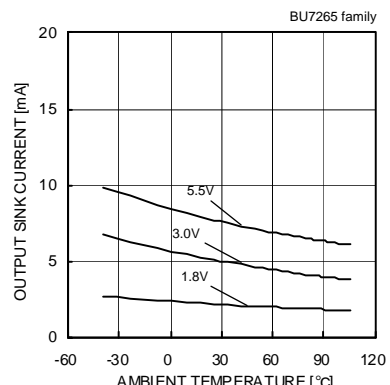
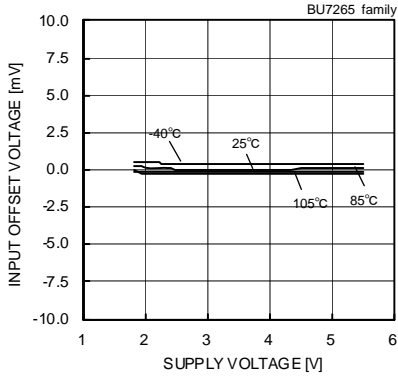

Fig.12

Output Sink Current - Ambient Temperature (VOUT=VSS+0.4[V])

(\*The above data is ability value of sample, it is not guaranteed. BU7265G: -40[°C] ~ +85[°C] BU7265SG: -40[°C] ~ +105[°C])

OBU7265 family



**Fig.13**  
Input Offset Voltage – Supply Voltage  
(Vicm=VDD, VOUT=0.1[V])

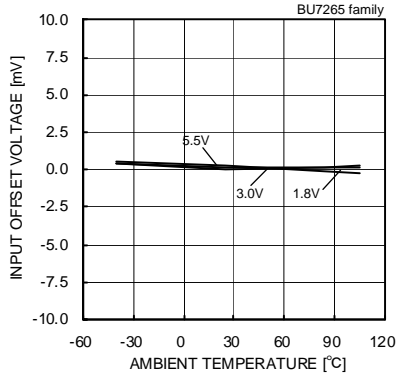

**Fig.14**  
Input Offset Voltage – Ambient Temperature  
(Vicm=VDD, VOUT=0.1[V])

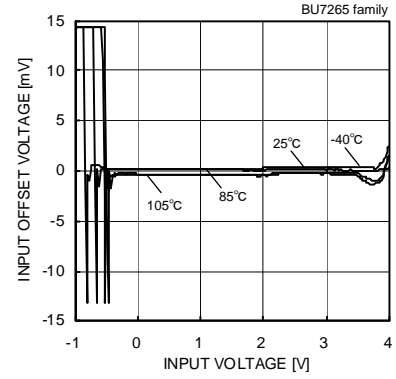

**Fig.15**  
Input Offset Voltage – Input Voltage  
(VDD=3[V])

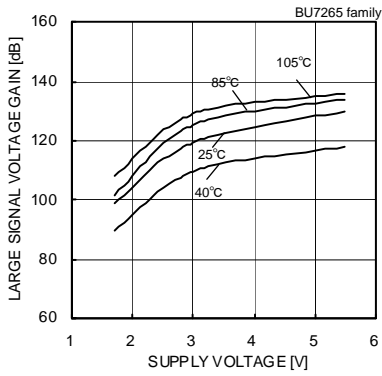

**Fig.16**  
Large Signal Voltage Gain  
– Supply Voltage

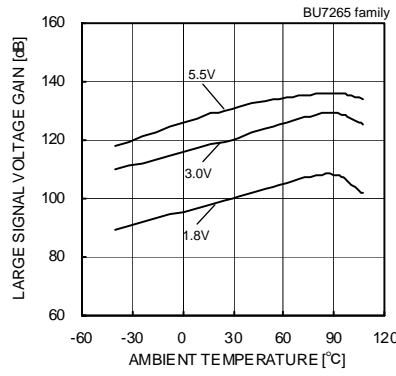

**Fig.17**  
Large Signal Voltage Gain  
– Ambient Temperature

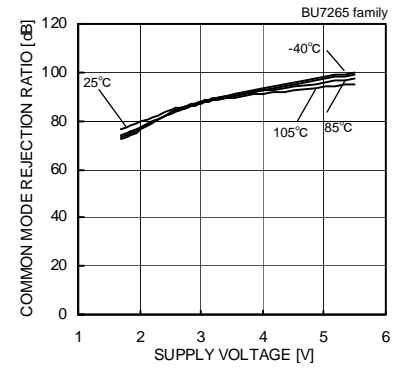

**Fig.18**  
Common Mode Rejection Ratio  
– Supply Voltage (VDD=3[V])

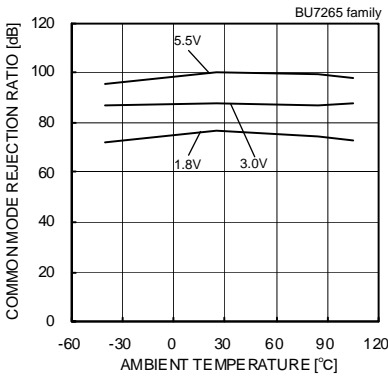

**Fig.19**  
Common Mode Rejection  
– Ambient Temperature  
(VDD=3[V])

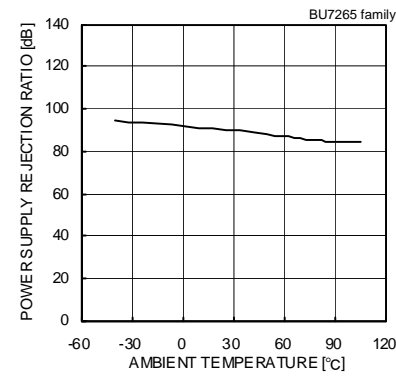

**Fig.20**  
Power Supply Rejection Ratio  
– Ambient Temperature

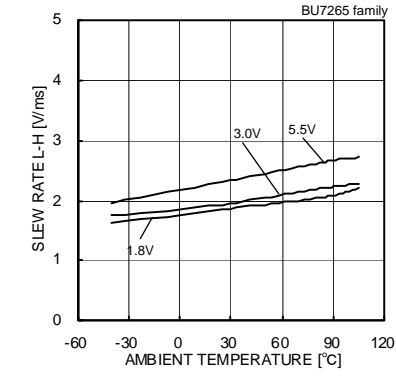

**Fig.21**  
Slew Rate L-H  
– Ambient Temperature

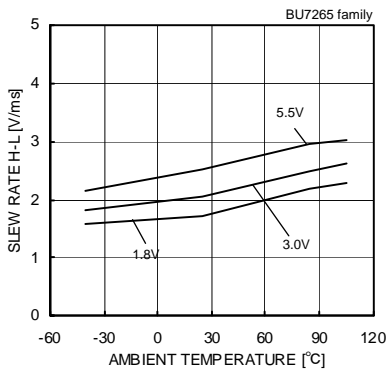

**Fig.22**  
Slew Rate H-L – Ambient Temperature

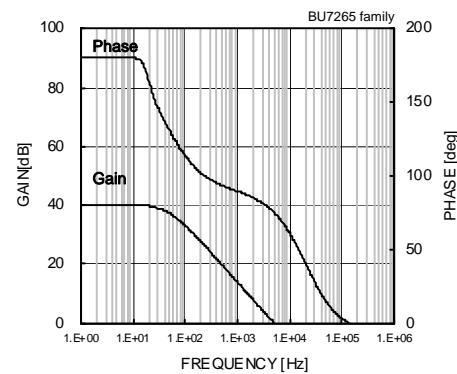

**Fig.23**  
Voltage Gain – frequency

(\*)The above data is ability value of sample, it is not guaranteed. BU7265G: -40[°C] ~ +85[°C] BU7265SG: -40[°C] ~ +105[°C]



OBU7271 family

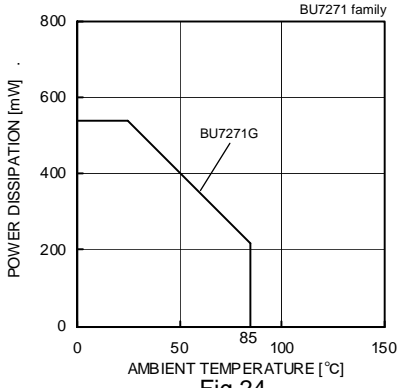

Fig.24

Derating curve

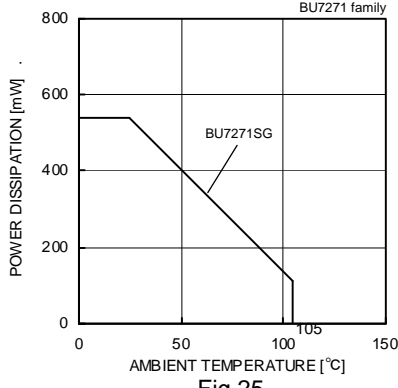

Fig.25

Derating curve

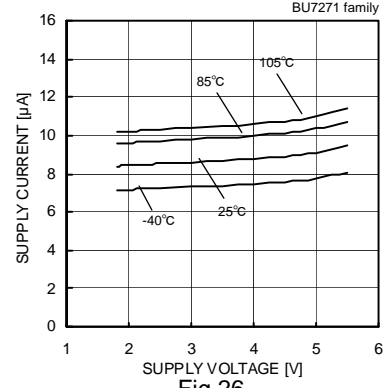

Fig.26

Supply Current – Supply Voltage

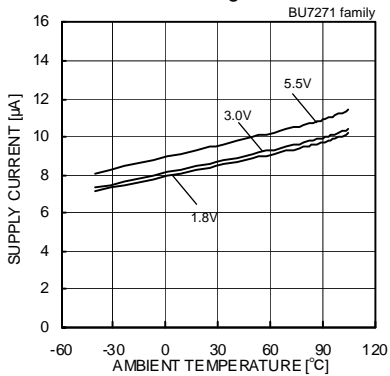

Fig.27

Supply Current – Ambient Temperature

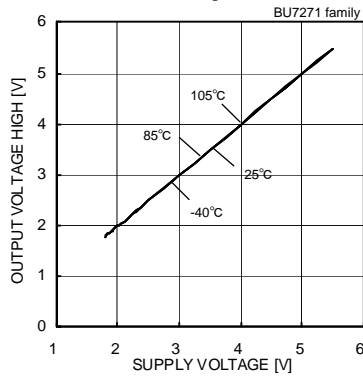

Fig.28

Output Voltage High – Supply Voltage (RL=10[kΩ])

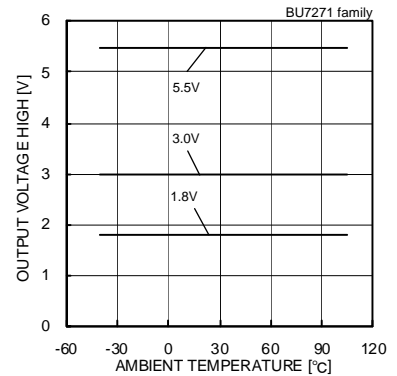

Fig.29

Output Voltage High – Ambient Temperature (RL=10[kΩ])

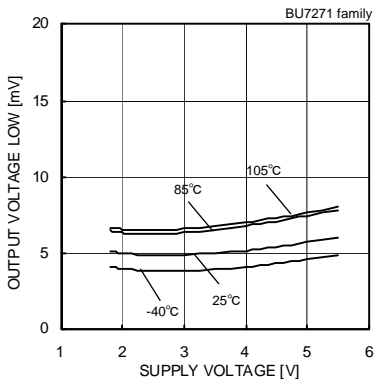

Fig.30

Output Voltage Low – Supply Voltage (RL=10[kΩ])

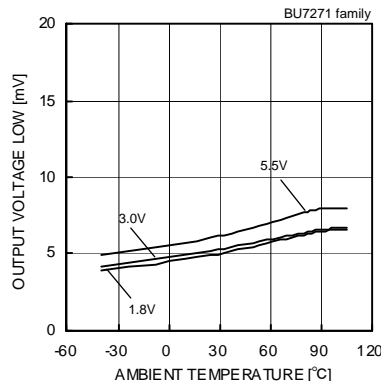

Fig.31

Output Voltage Low – Ambient Temperature (RL=10[kΩ])

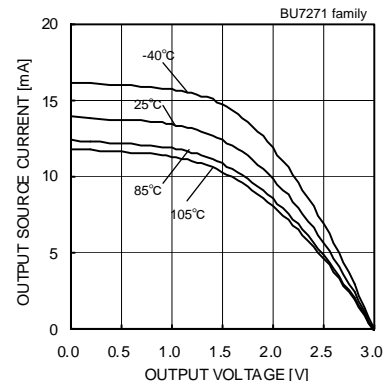

Fig.32

Output Source Current – Output Voltage (VDD=3[V])

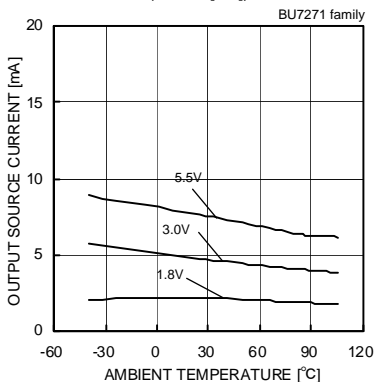

Fig.33

Output Source Current – Ambient Temperature (VOUT=VDD-0.4[V])

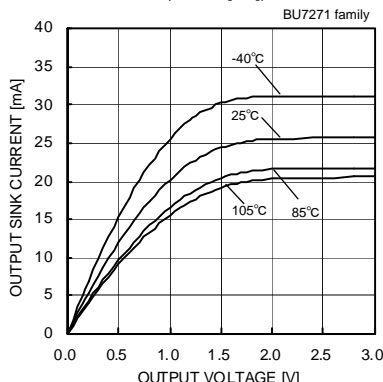

Fig.34

Output Sink Current – Output Voltage (VDD=3[V])

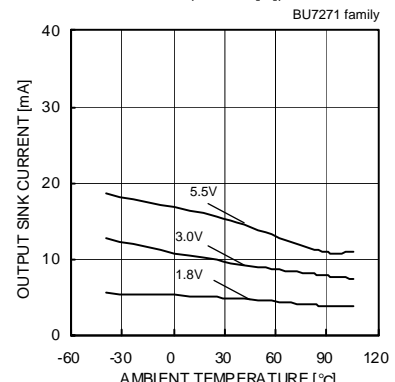

Fig.35

Output Sink Current – Ambient Temperature (VOUT=VSS+0.4[V])

(\*The above data is ability value of sample, it is not guaranteed. BU7271G: -40[°C] ~ +85[°C] BU7271SG: -40[°C] ~ +105[°C]

OBU7271 family

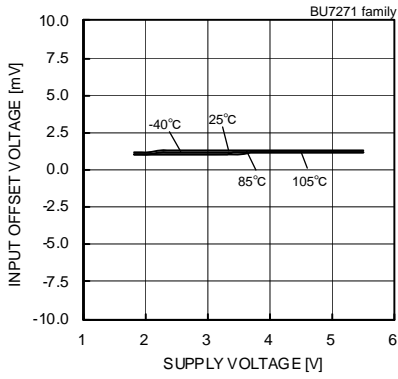

Fig.36

Input Offset Voltage – Supply Voltage  
(Vicm=VDD, VOUT=0.1[V])

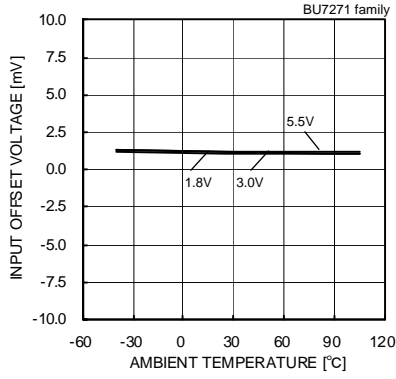

Fig.37

Input Offset Voltage – Ambient Temperature  
(Vicm=VDD, VOUT=1.5[V])

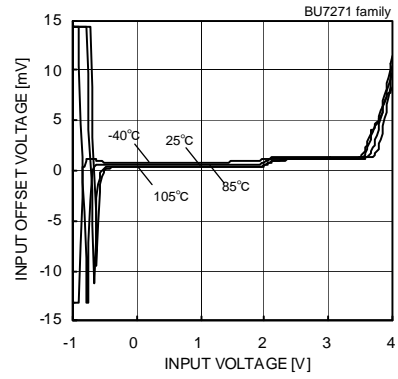

Fig.38

Input Offset Voltage – Input Voltage  
(VDD=3[V])

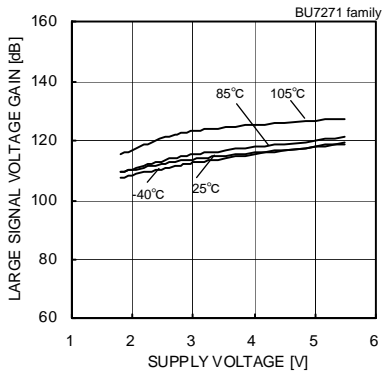

Fig.39

Large Signal Voltage Gain  
– Supply Voltage

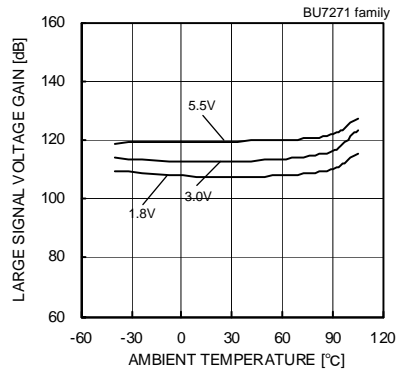

Fig.40

Large Signal Voltage Gain  
– Ambient Temperature

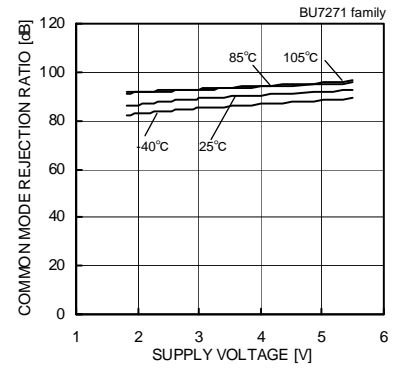

Fig.41

Common Mode Rejection Ratio  
– Supply Voltage  
(VDD=3[V])

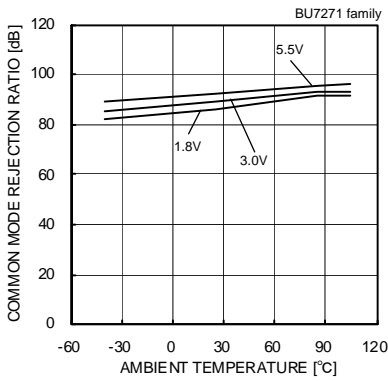

Fig.42

Common Mode Rejection Ratio  
– Ambient Temperature

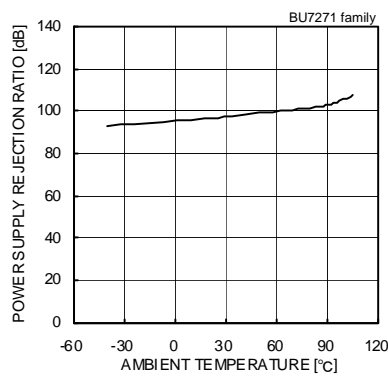

Fig.43

Power Supply Rejection Ratio  
– Ambient Temperature

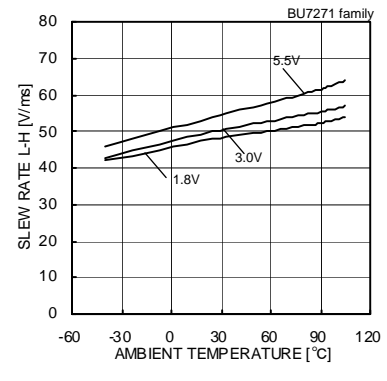

Fig.44

Slew Rate L-H – Ambient Temperature

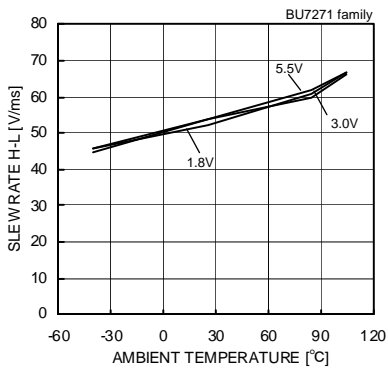

Fig.45

Slew Rate H-L – Ambient Temperature

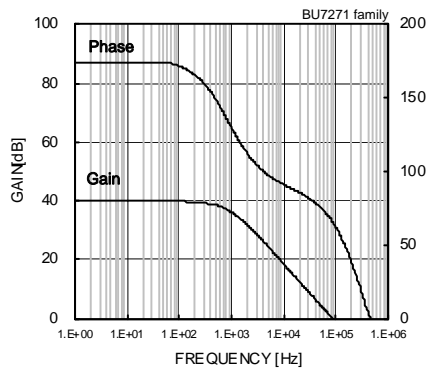

Fig.46

Voltage Gain – Frequency

(\*)The above data is ability value of sample, it is not guaranteed. BU7271G: -40[°C] ~ +85[°C] BU7271SG: -40[°C] ~ +105[°C]

OBU7205 family

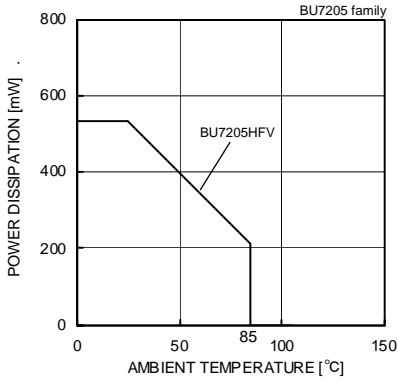

Fig.47

Derating curve

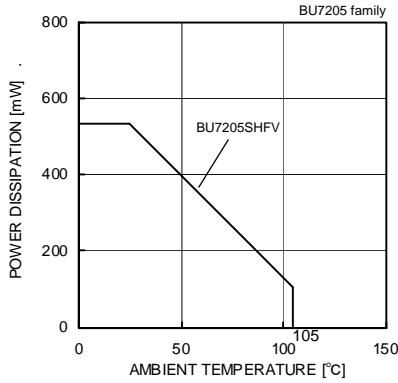

Fig.48

Derating curve

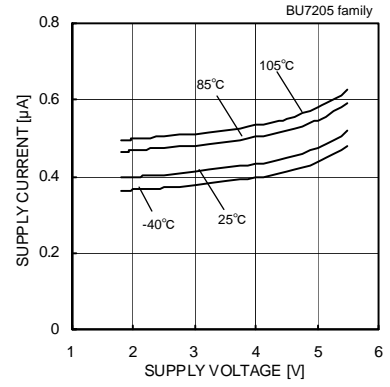

Fig.49

Supply Current - Supply Voltage

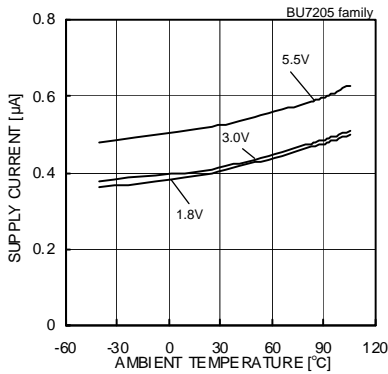

Fig.50

Supply Current - Ambient Temperature

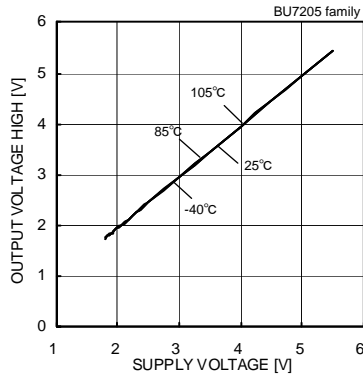

Fig.51

Output Voltage High - Supply Voltage (RL=10[kΩ])

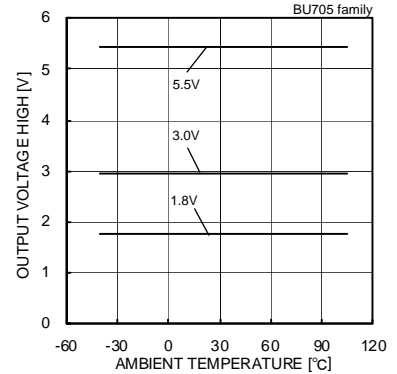

Fig.52

Output Voltage High - Ambient Temperature (RL=10[kΩ])

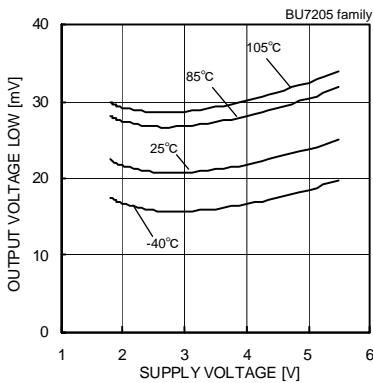

Fig.53

Output Voltage Low - Supply Voltage (RL=10[kΩ])

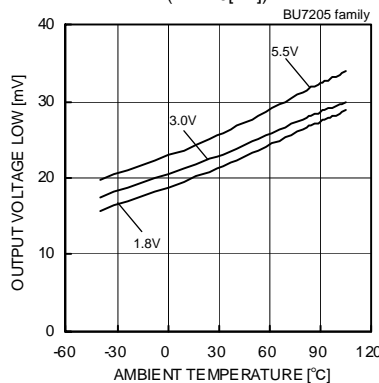

Fig.54

Output Voltage Low - Ambient Temperature (RL=10[kΩ])

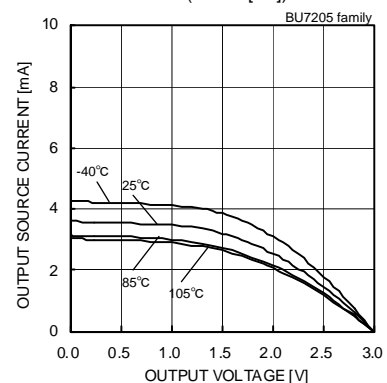

Fig.55

Output Source Current - Output Voltage (VDD=3[V])

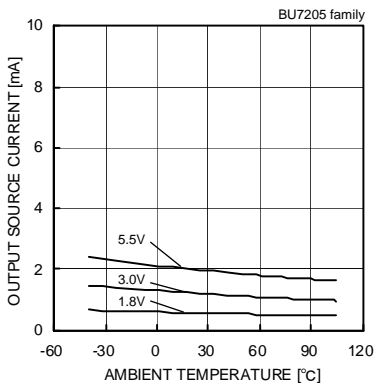

Fig.56

Output Source Current - Ambient Temperature (VOUT=VDD-0.4[V])

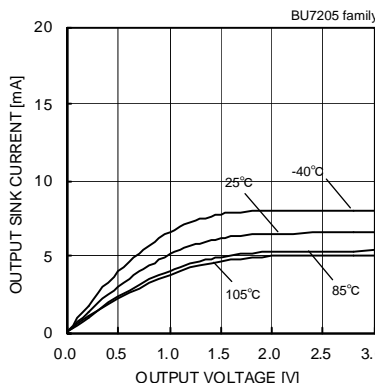

Fig.57

Output Sink Current - Output Voltage (VDD=3[V])

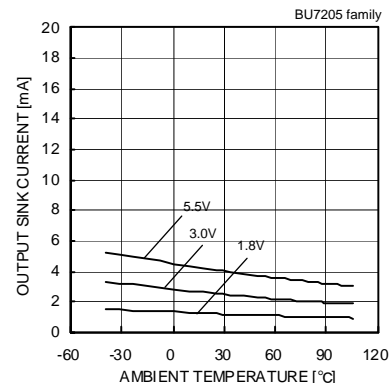

Fig.58

Output Sink Current - Ambient Temperature (VOUT=VSS+0.4[V])

(\*The above data is ability value of sample, it is not guaranteed. BU7205HFV: -40[°C] ~ +85[°C] BU7205SHFV: -40[°C] ~ +105[°C]

OBU7205 family

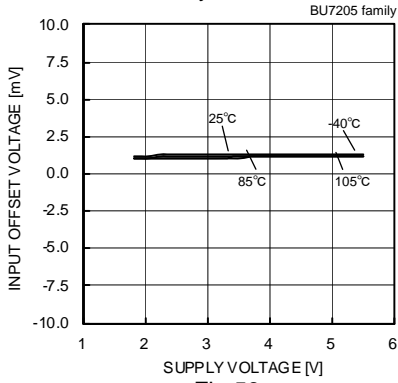

Fig.59

Input Offset Voltage – Supply Voltage  
(Vicm=VDD, VOUT=1.5[V])

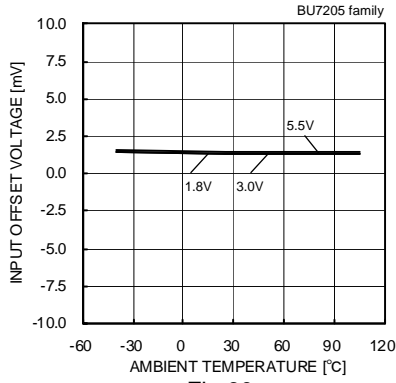

Fig.60

Input Offset Voltage – Ambient Temperature  
(Vicm=VDD, VOUT=1.5[V])

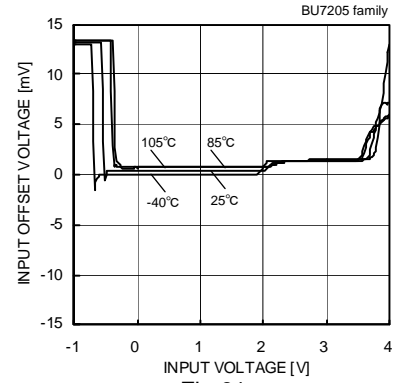

Fig.61

Input Offset Voltage – Input Voltage  
(VDD=3[V])

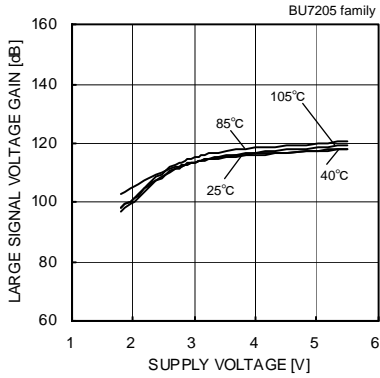

Fig.62

Large Signal Voltage Gain  
– Supply Voltage

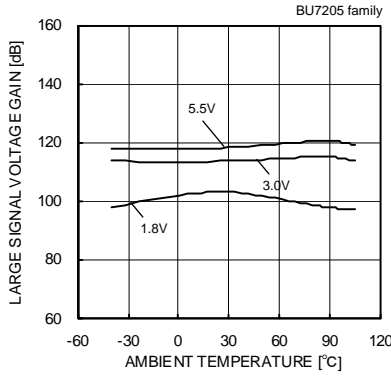

Fig.63

Large Signal Voltage Gain  
– Ambient Temperature

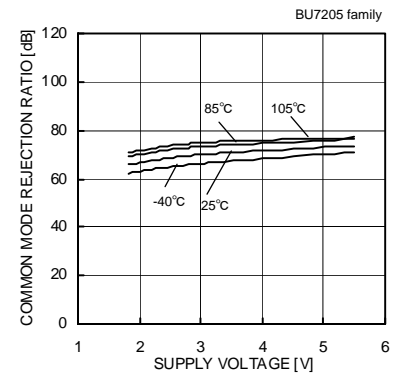

Fig.64

Common Mode Rejection Ratio  
– Supply Voltage

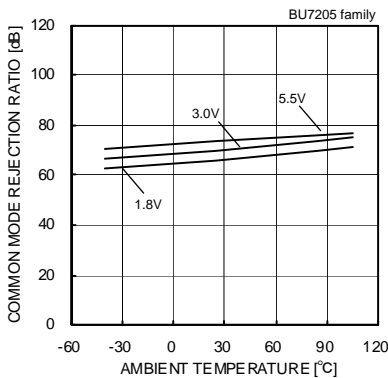

Fig.65

Common Mode Rejection Ratio  
– Ambient Temperature

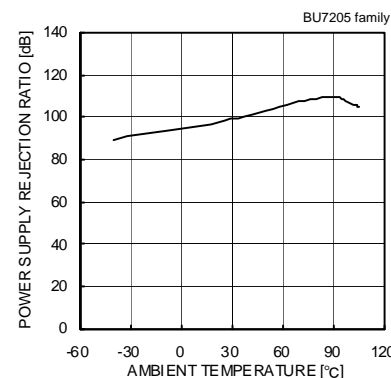

Fig.66

Power Supply Rejection Ratio  
– Ambient Temperature

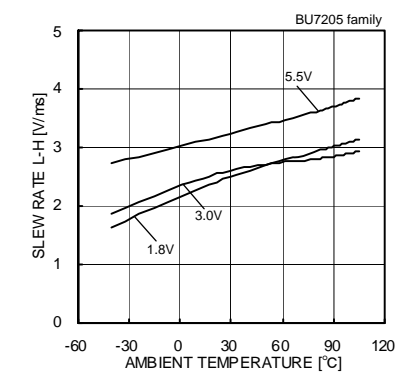

Fig.67

Slew Rate L-H – Ambient Temperature

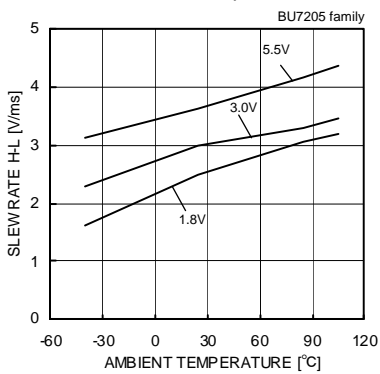

Fig.68

Slew Rate H-L – Ambient Temperature

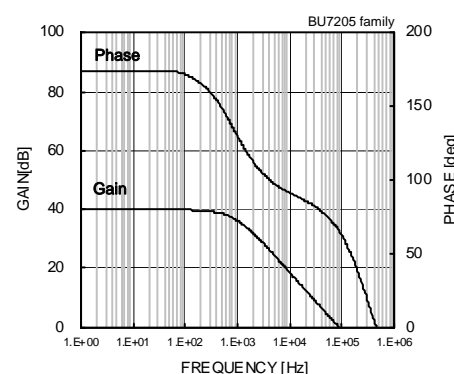

Fig.69

Voltage Gain – Frequency

(\*The above data is ability value of sample, it is not guaranteed. BU7205HFV: -40[°C] ~ +85[°C] BU7205SHFV: -40[°C] ~ +105[°C]

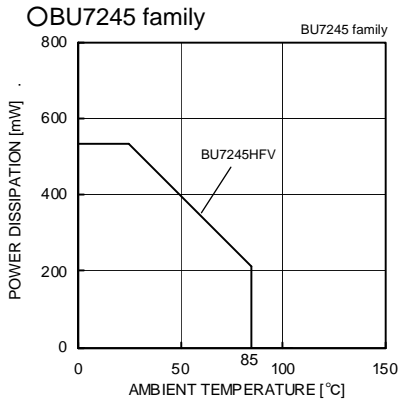

Fig. 70

Derating curve

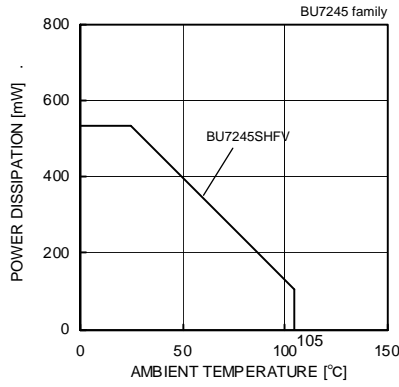

Fig. 71

Derating curve

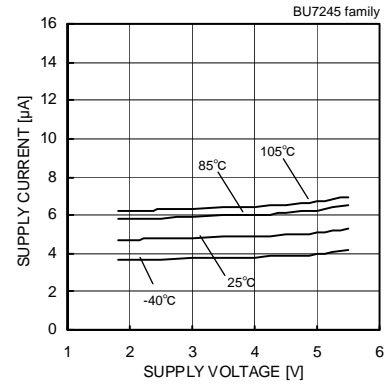

Fig. 72

Supply Current - Supply Voltage

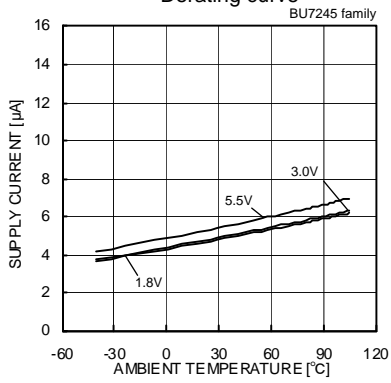

Fig. 73

Supply Current - Ambient Temperature

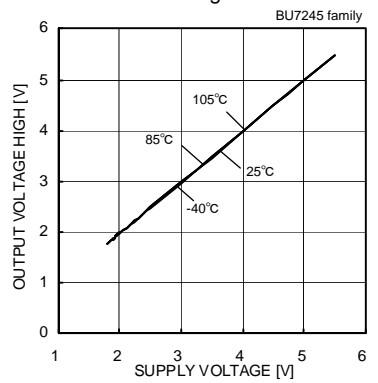

Fig. 74

Output Voltage High - Supply Voltage (RL=10[kΩ])

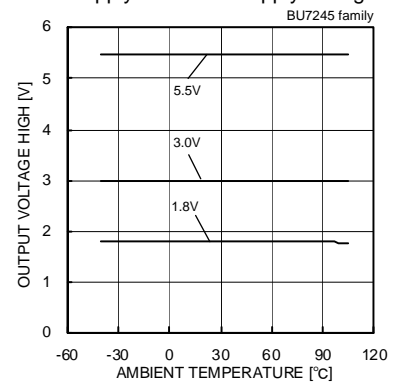

Fig. 75

Output Voltage High - Ambient Temperature (RL=10[kΩ])

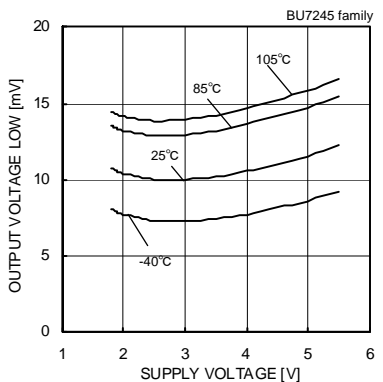

Fig. 76

Output Voltage Low - Supply Voltage (RL=10[kΩ])

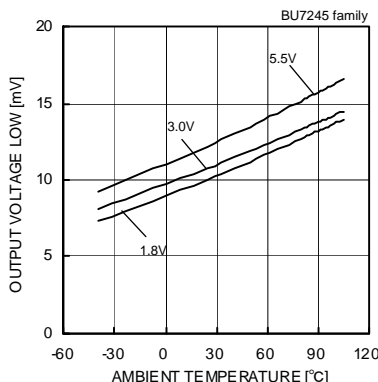

Fig. 77

Output Voltage Low - Ambient Temperature (RL=10[kΩ])

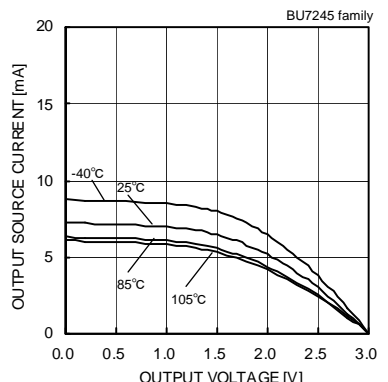

Fig. 78

Output Source Current - Output Voltage (VDD=3[V])

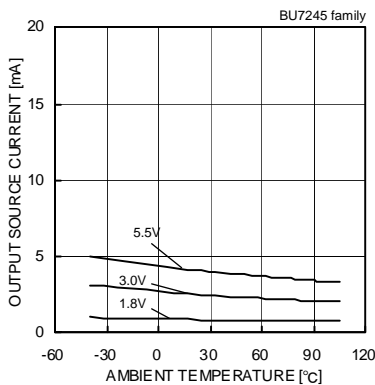

Fig. 79

Output Source Current - Ambient Temperature (VOUT=VDD-0.4[V])

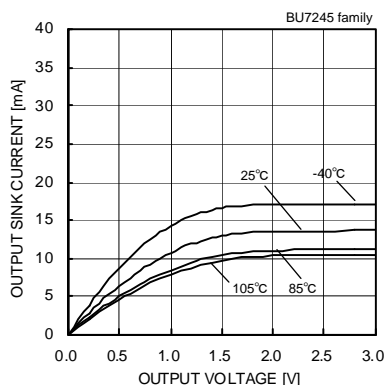

Fig. 80

Output Sink Current - Output Voltage (VDD=3[V])

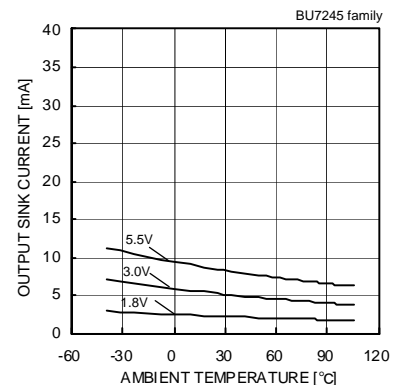
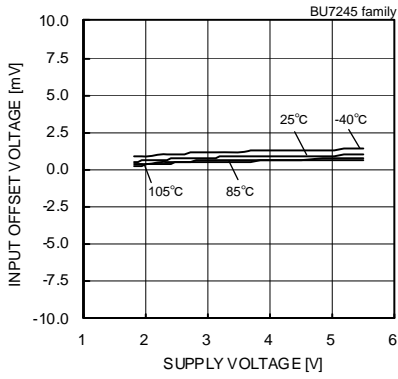

Fig. 81

Output Sink Current - Ambient Temperature (VOUT=VSS+0.4[V])

(\*The above data is ability value of sample, it is not guaranteed. BU7245HFV: -40[°C] ~ +85[°C] BU7245SHFV: -40[°C] ~ +105[°C]

OBU7245 family



**Fig.82**  
 Input Offset Voltage – Supply Voltage  
 (Vicm=VDD, VOUT=1.5[V])

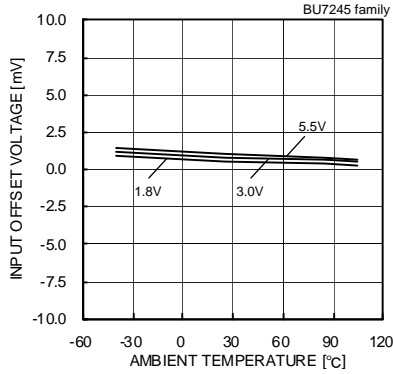

**Fig.83**  
 Input Offset Voltage – Ambient Temperature  
 (Vicm=VDD, VOUT=1.5[V])

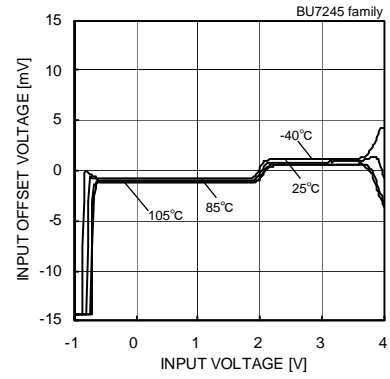

**Fig.84**  
 Input Offset Voltage – Input Voltage  
 (VDD=3[V])

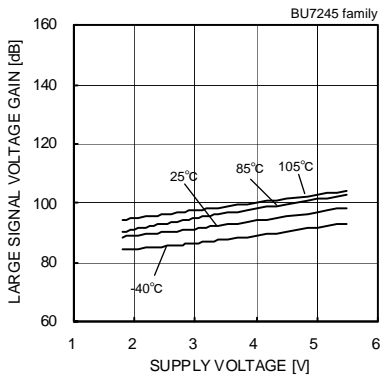

**Fig.85**  
 Large Signal Voltage Gain  
 – Supply Voltage

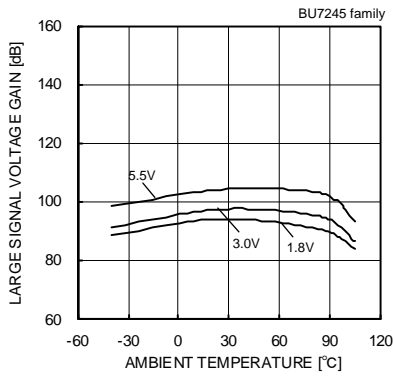

**Fig.86**  
 Large Signal Voltage Gain  
 – Ambient Temperature

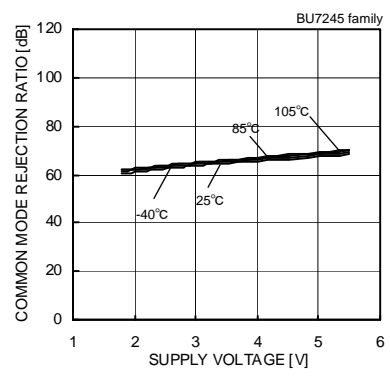

**Fig.87**  
 Common Mode Rejection Ratio  
 – Supply Voltage

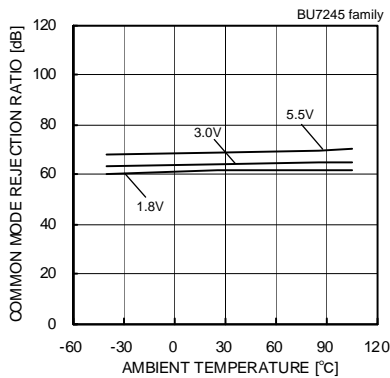

**Fig.88**  
 Common Mode Rejection Ratio  
 – Ambient Temperature

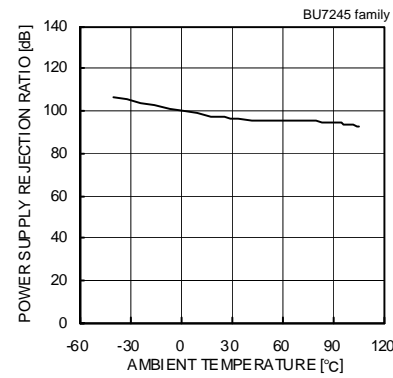

**Fig.89**  
 Power Supply Rejection Ratio  
 – Ambient Temperature

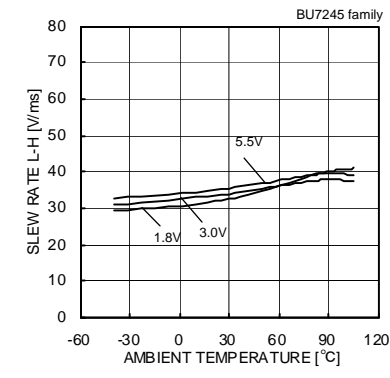

**Fig.90**  
 Slew Rate L-H – Ambient Temperature

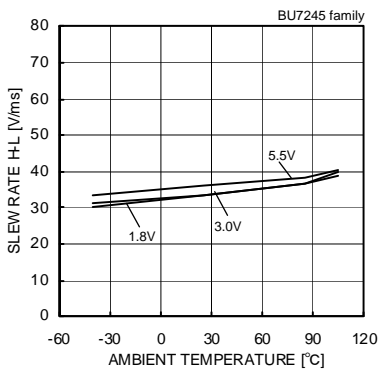

**Fig.91**  
 Slew Rate H-L – Ambient Temperature

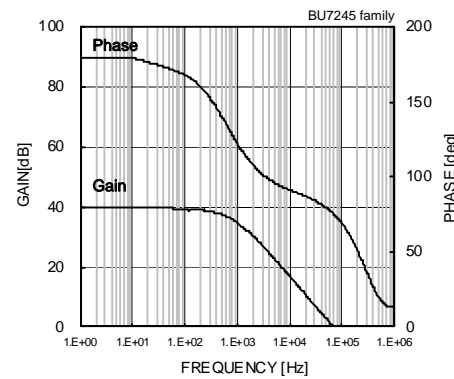

**Fig.92**  
 Gain – Frequency

(\*The above data is ability value of sample, it is not guaranteed. BU7245HFV: -40[°C] ~ +85[°C] BU7245SHFV: -40[°C] ~ +105[°C]

OBU7411 family

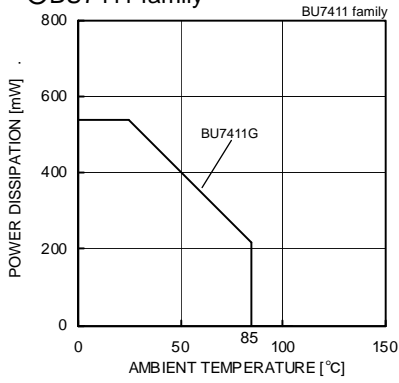

Fig.93

Derating curve

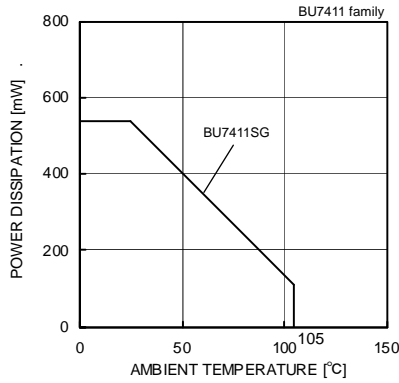

Fig.94

Derating curve

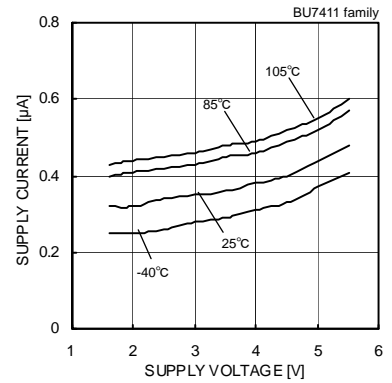

Fig.95

Supply Current - Supply Voltage

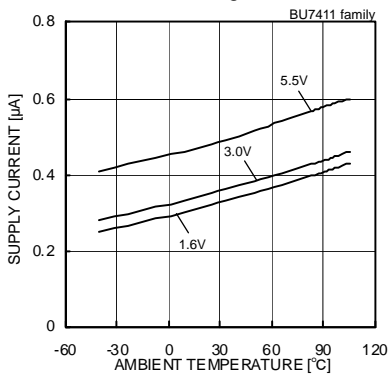

Fig.96

Supply Current - Ambient Temperature

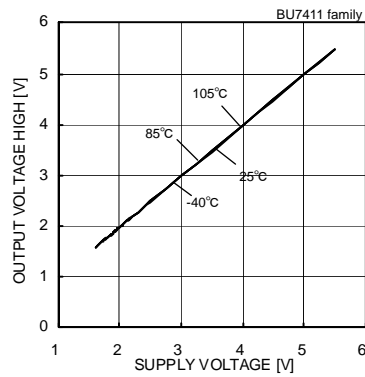

Fig.97

Output Voltage High - Supply Voltage (RL=10[kΩ])

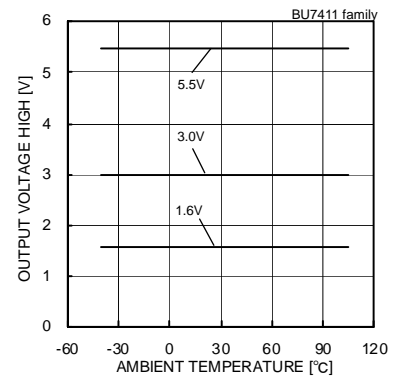

Fig.98

Output Voltage High - Ambient Temperature (RL=10[kΩ])

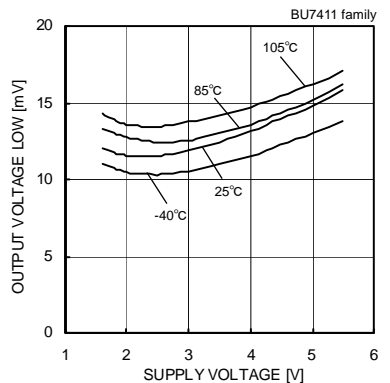

Fig.99

Output Voltage Low - Supply Voltage (RL=10[kΩ])

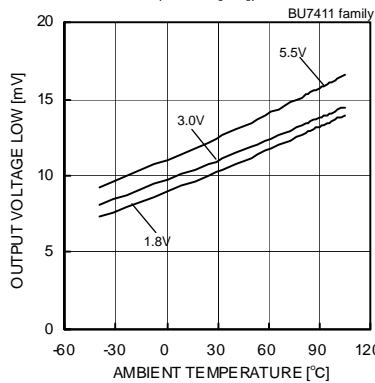

Fig.100

Output Voltage Low - Ambient Temperature (RL=10[kΩ])

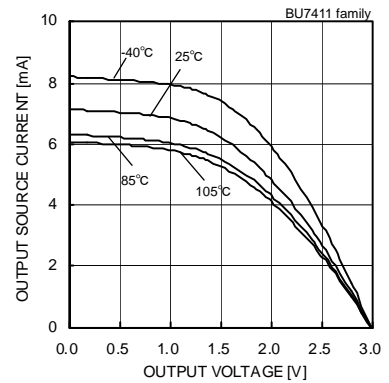

Fig.101

Output Source Current - Output Voltage (VDD=3[V])

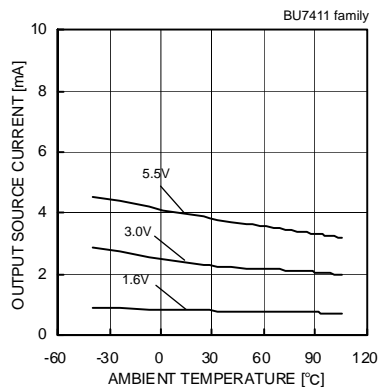

Fig.102

Output Source Current - Ambient Temperature (VOUT=VDD-0.4[V])

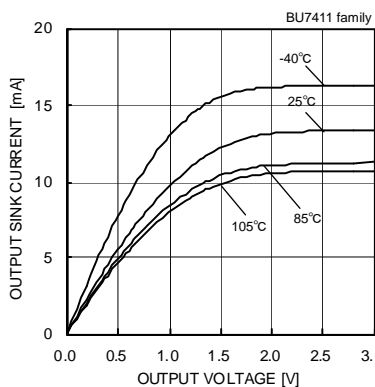

Fig.103

Output Sink Current - Output Voltage (VDD=3[V])

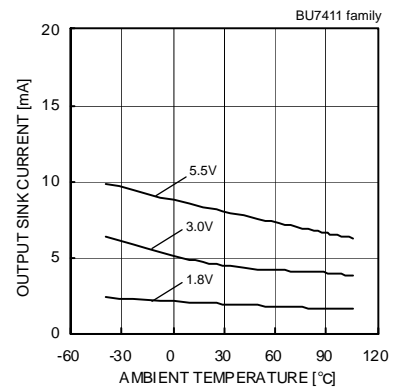
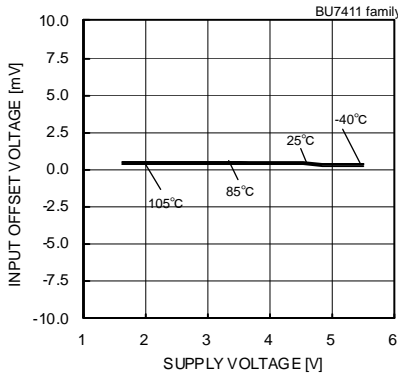

Fig.104

Output Sink Current - Ambient Temperature (VOUT=VSS+0.4[V])

(\*The above data is ability value of sample, it is not guaranteed. BU7411G: -40[°C] ~ +85[°C] BU7411SG: -40[°C] ~ +105[°C]

OBU7411 family



**Fig.105**  
 Input Offset Voltage – Supply Voltage  
 (Vicm=VDD-1.2[V], VOUT=1.5[V])

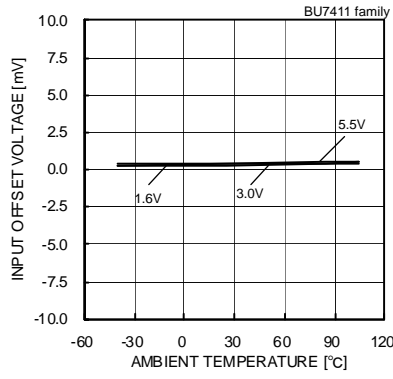

**Fig.106**  
 Input Offset Voltage – Ambient Temperature  
 (Vicm=VDD-1.2[V], VOUT=1.5[V])

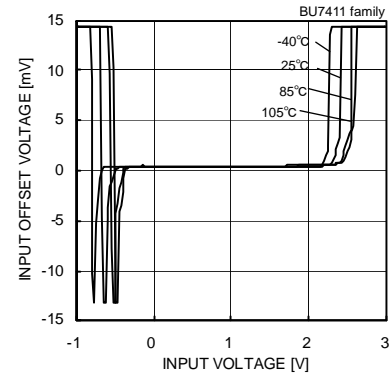

**Fig.107**  
 Input Offset Voltage – Input Voltage  
 (VDD=3[V])

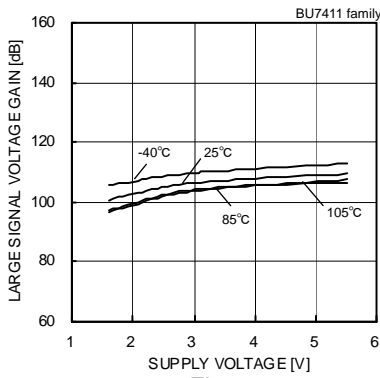

**Fig.108**  
 Large Signal Voltage Gain  
 – Supply Voltage

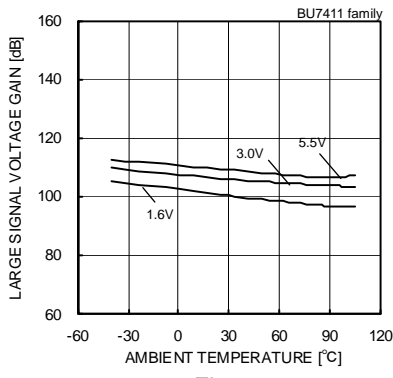

**Fig.109**  
 Large Signal Voltage Gain  
 – Ambient Temperature

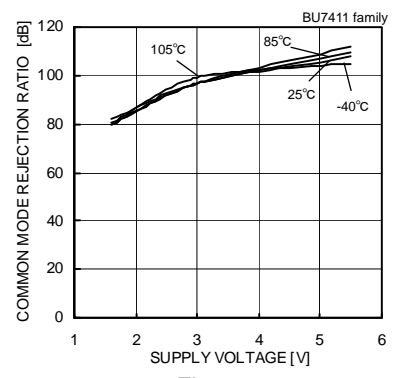

**Fig.110**  
 Common Mode Rejection Ratio  
 – Supply Voltage

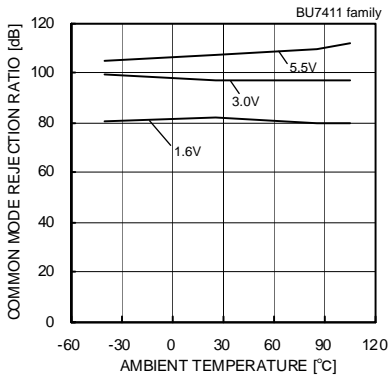

**Fig.111**  
 Common Mode Rejection Ratio  
 – Ambient Temperature

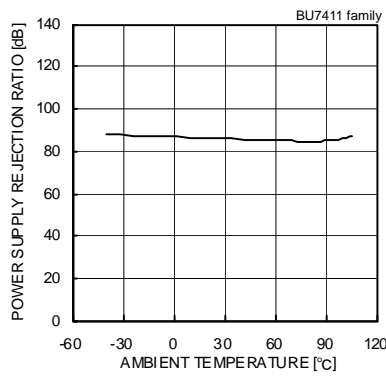

**Fig.112**  
 Power Supply Rejection Ratio  
 – Ambient Temperature

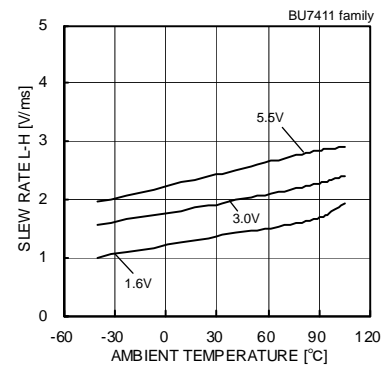

**Fig.113**  
 Slew Rate L-H – Ambient Temperature

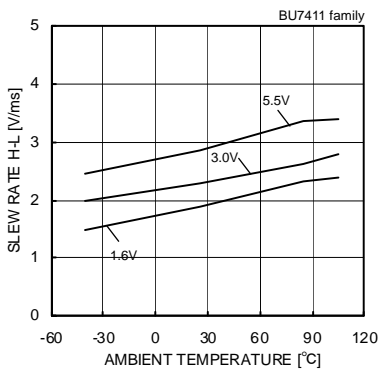

**Fig.114**  
 Slew Rate H-L – Ambient Temperature

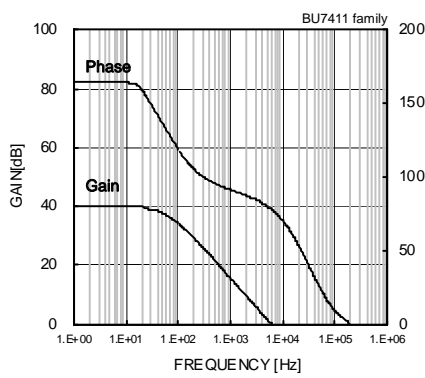

**Fig.115**  
 Voltage Gain – Frequency

(\*)The above data is ability value of sample, it is not guaranteed. BU7411G: -40[°C] ~ +85[°C] BU7411SG: -40[°C] ~ +105[°C]



OBU7421 family

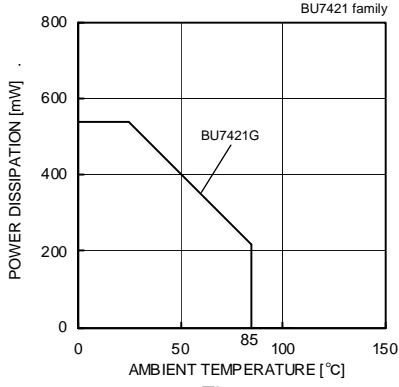

Fig.116  
Derating curve

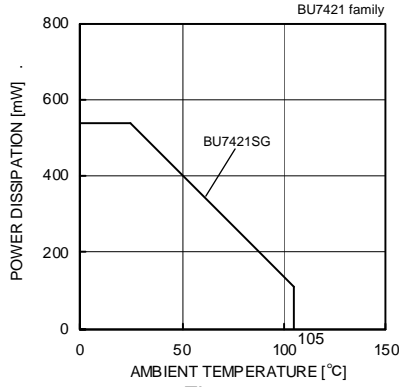

Fig.117  
Derating curve

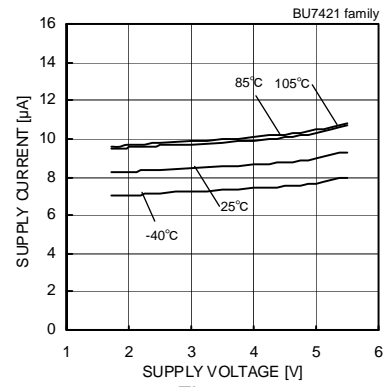

Fig.118  
Supply Current - Supply Voltage

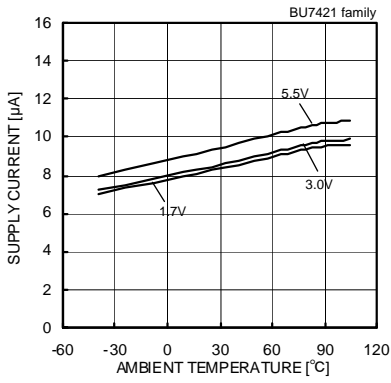

Fig.119  
Supply Current - Ambient Temperature

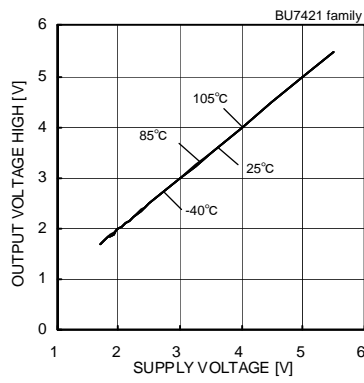

Fig.120  
Output Voltage High - Supply Voltage  
(RL=10[kΩ])

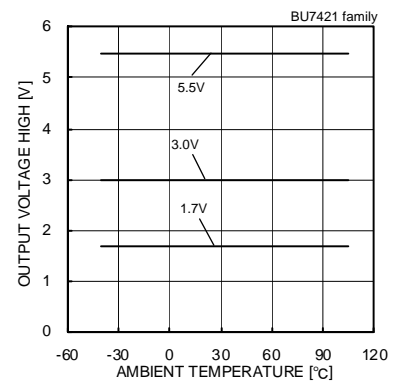

Fig.121  
Output Voltage High - Ambient Temperature  
(RL=10[kΩ])

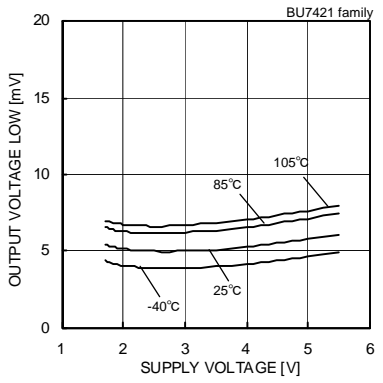

Fig.122  
Output Voltage Low - Supply Voltage  
(RL=10[kΩ])

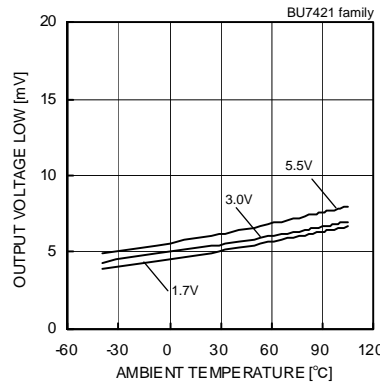

Fig.123  
Output Voltage Low - Ambient Temperature  
(RL=10[kΩ])

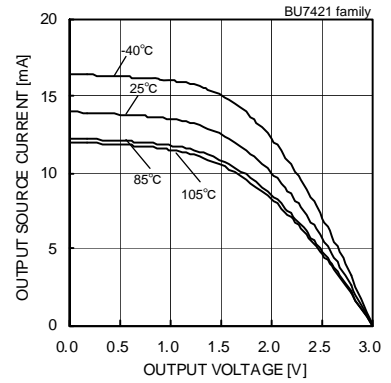

Fig.124  
Output Source Current - Output Voltage  
(VDD=3[V])

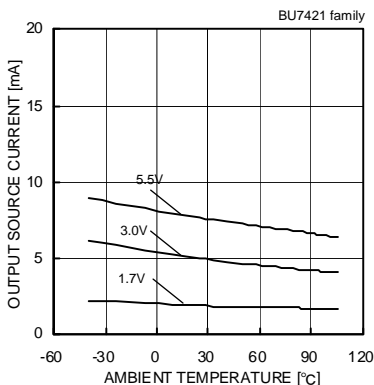

Fig.125  
Output Source Current - Ambient Temperature  
(VOUT=VDD-0.4[V])

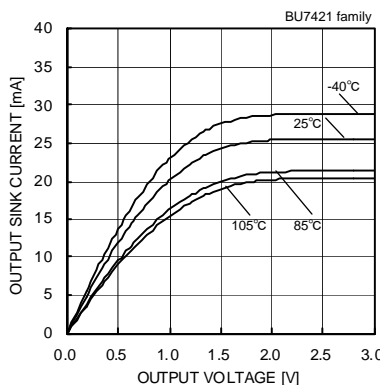

Fig.126  
Output Sink Current - Output Voltage  
(VDD=3[V])

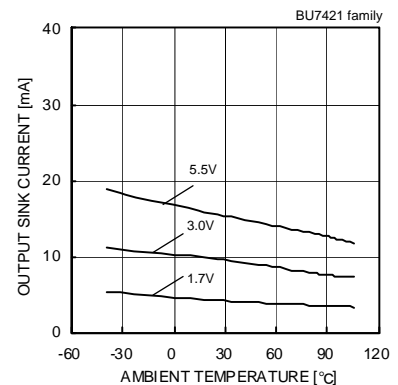
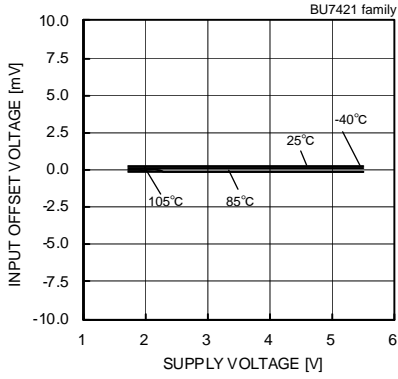

Fig.127  
Output Sink Current - Ambient Temperature  
(VOUT=VSS+0.4[V])

(\*The above data is ability value of sample, it is not guaranteed. BU7421G: -40[°C] ~ +85[°C] BU7421SG: -40[°C] ~ +105[°C])

OBU7421 family



**Fig.128**  
Input Offset Voltage – Supply Voltage  
( $V_{cm}=V_{DD}-1.2[V]$ ,  $V_{OUT}=1.5[V]$ )

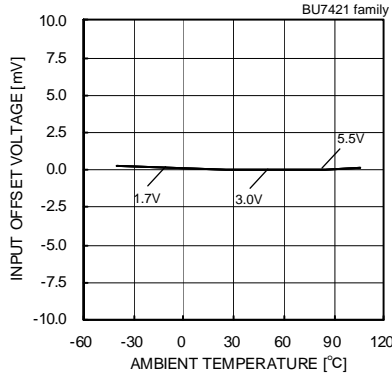

**Fig.129**  
Input Offset Voltage – Ambient Temperature  
( $V_{cm}=V_{DD}-1.2[V]$ ,  $V_{OUT}=1.5[V]$ )

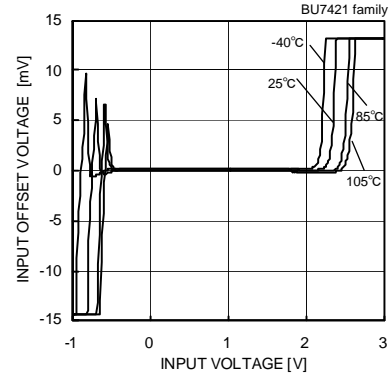

**Fig.130**  
Input Offset Voltage – Input Voltage  
( $V_{DD}=3[V]$ )

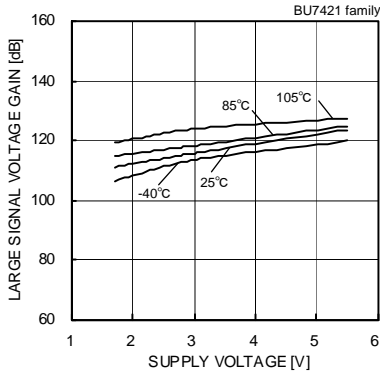

**Fig.131**  
Large Signal Voltage Gain  
– Supply Voltage

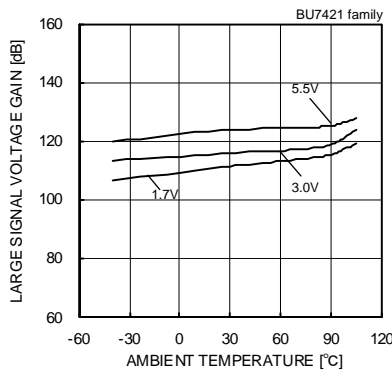

**Fig.132**  
Large Signal Voltage Gain  
– Ambient Temperature

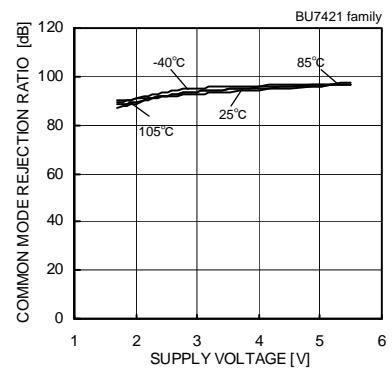

**Fig.133**  
Common Mode Rejection Ratio  
– Supply Voltage

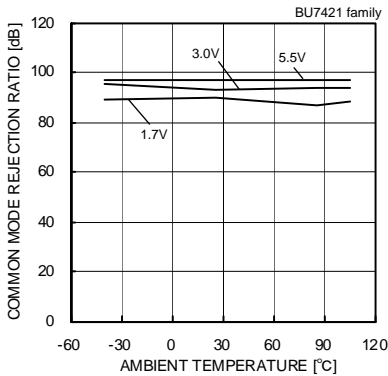

**Fig.134**  
Common Mode Rejection Ratio  
– Ambient Temperature

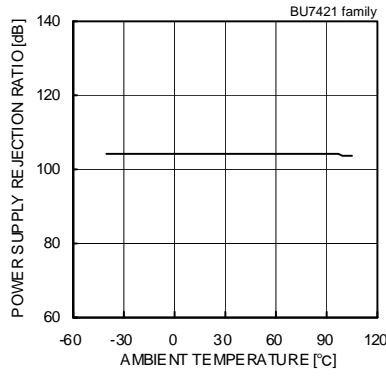

**Fig.135**  
Power Supply Rejection Ratio  
– Ambient Temperature

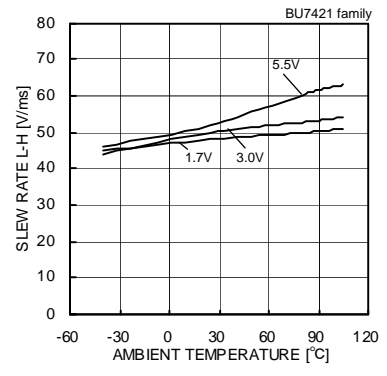

**Fig.136**  
Slew Rate L-H – Ambient Temperature

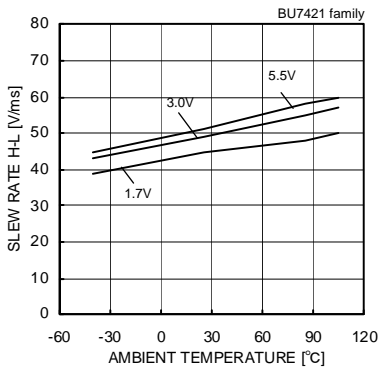

**Fig.137**  
Slew Rate H-L – Ambient Temperature

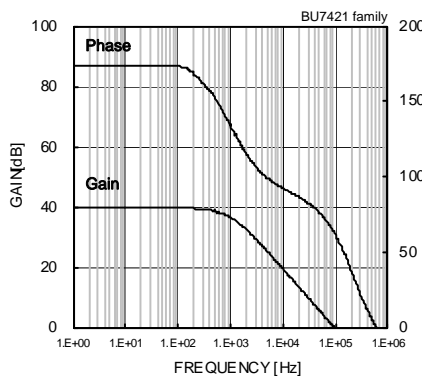

**Fig.138**  
Voltage Gain – Frequency

(\*)The above data is ability value of sample, it is not guaranteed. BU7421G: -40[°C] ~ +85[°C] BU7421SG: -40[°C] ~ +105[°C]

OBU7475 family

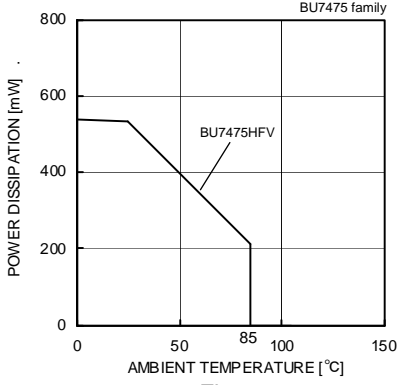

Fig.139

Derating curve

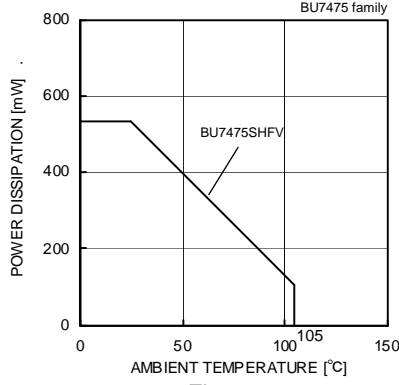

Fig.140

Derating curve

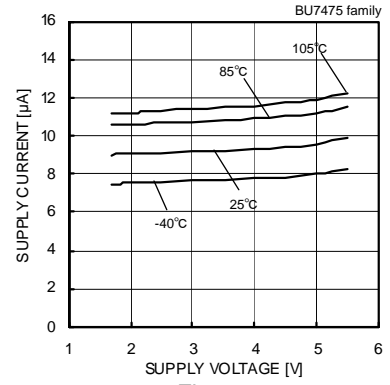

Fig.141

Supply Current - Supply Voltage

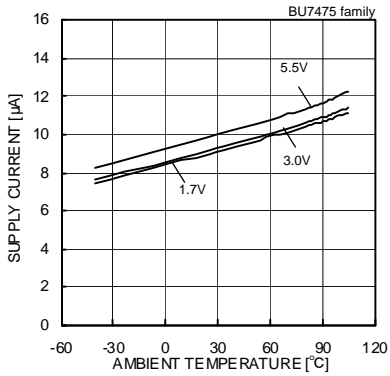

Fig.142

Supply Current - Ambient Temperature

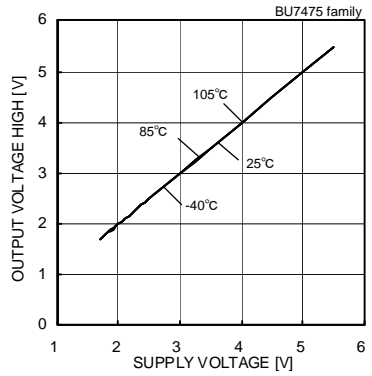

Fig.143

Output Voltage High - Supply Voltage (RL=10[kΩ])

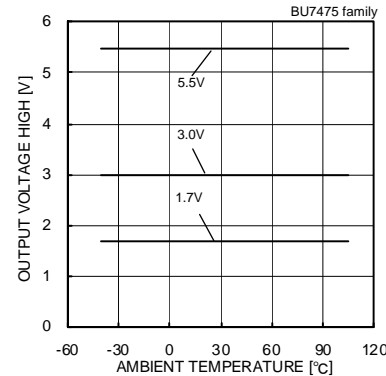

Fig.144

Output Voltage High - Ambient Temperature (RL=10[kΩ])

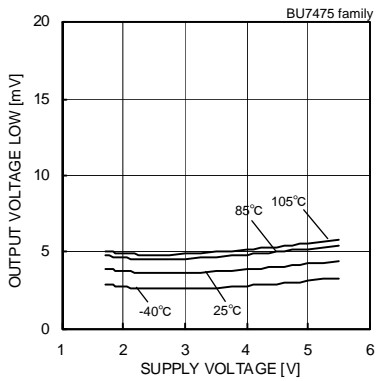

Fig.145

Output Voltage Low - Supply Voltage (RL=10[kΩ])

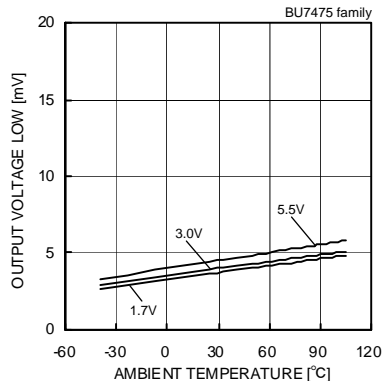

Fig.146

Output Voltage Low - Ambient Temperature (RL=10[kΩ])

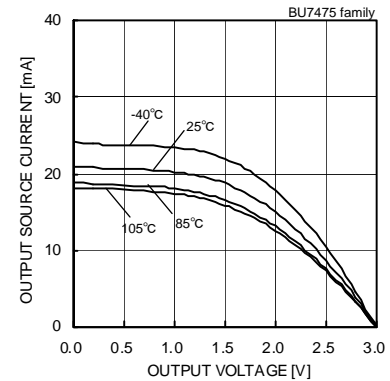

Fig.147

Output Source Current - Output Voltage (VDD=3[V])

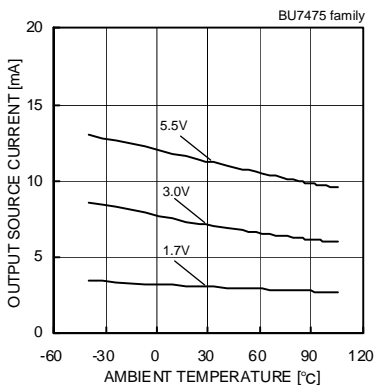

Fig.148

Output Source Current - Ambient Temperature (VOUT=VDD-0.4[V])

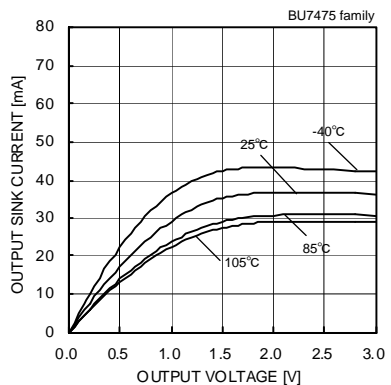

Fig.149

Output Sink Current - Output Voltage (VDD=3[V])

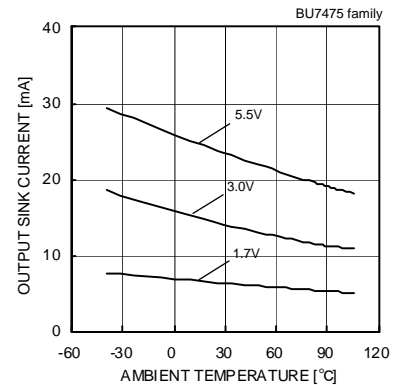
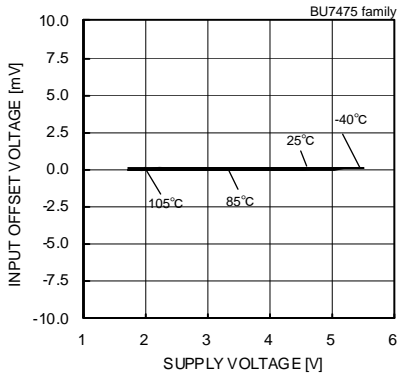

Fig.150

Output Sink Current - Ambient Temperature (VOUT=VSS+0.4[V])

(\*The above data is ability value of sample, it is not guaranteed. BU7475HFV: -40[°C] ~ +85[°C] BU7475SHFV: -40[°C] ~ +105[°C]

OBU7475 family



**Fig. 151**  
Input Offset Voltage – Supply Voltage  
(Vicm=VDD-1.2[V], VOUT=1.5[V])

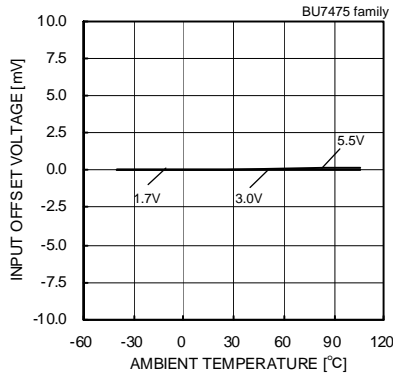

**Fig. 152**  
Input Offset Voltage – Ambient Temperature  
(Vicm=VDD-1.2[V], VOUT=1.5[V])

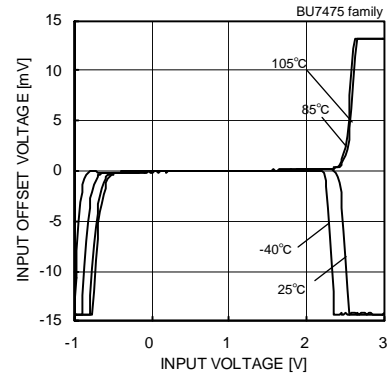

**Fig. 153**  
Input Offset Voltage – Input Voltage  
(VDD=3[V])

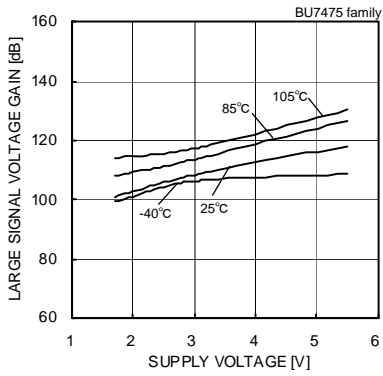

**Fig. 154**  
Large Signal Voltage Gain – Supply Voltage

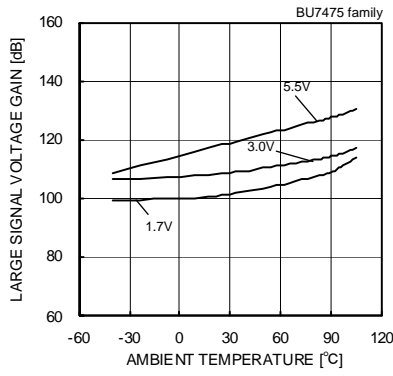

**Fig. 155**  
Large Signal Voltage Gain – Ambient Temperature

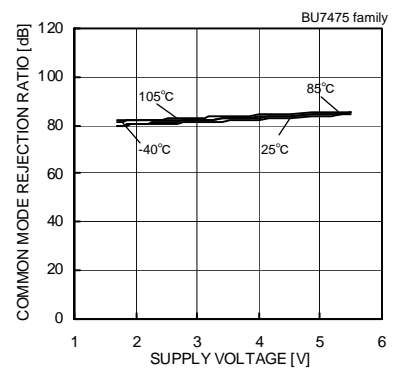

**Fig. 156**  
Common Mode Rejection Ratio – Supply Voltage

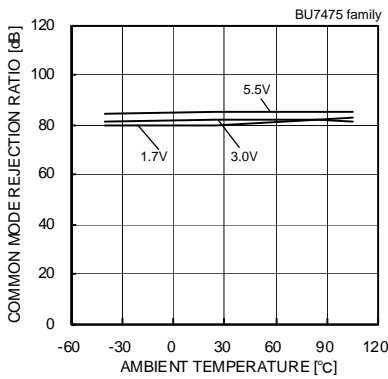

**Fig. 157**  
Common Mode Rejection Ratio – Ambient Temperature

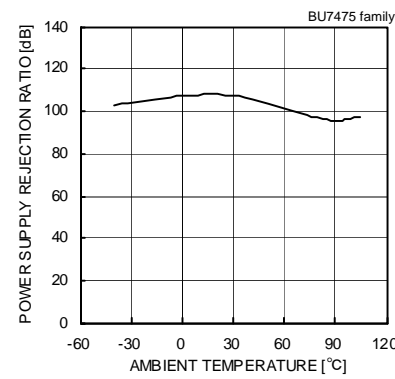

**Fig. 158**  
Power Supply Rejection Ratio – Ambient Temperature

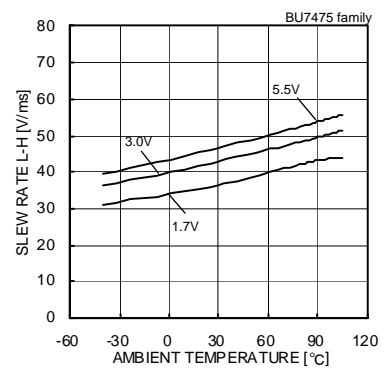

**Fig. 159**  
Slew Rate L-H – Ambient Temperature

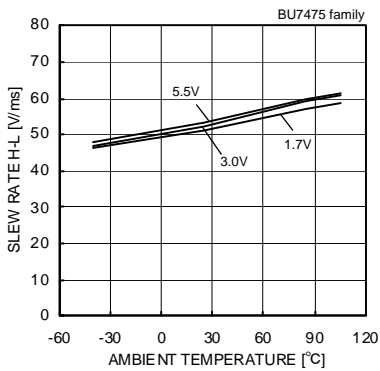

**Fig. 160**  
Slew Rate H-L – Ambient Temperature

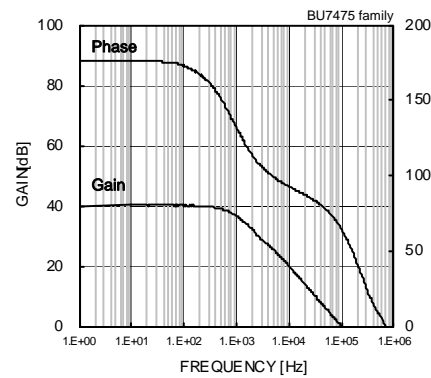

**Fig. 161**  
Voltage Gain – Frequency

(\*)The above data is ability value of sample, it is not guaranteed. BU7475HFV: -40[°C] ~ +85[°C] BU7475SHFV: -40[°C] ~ +105[°C]

● Schematic Diagram

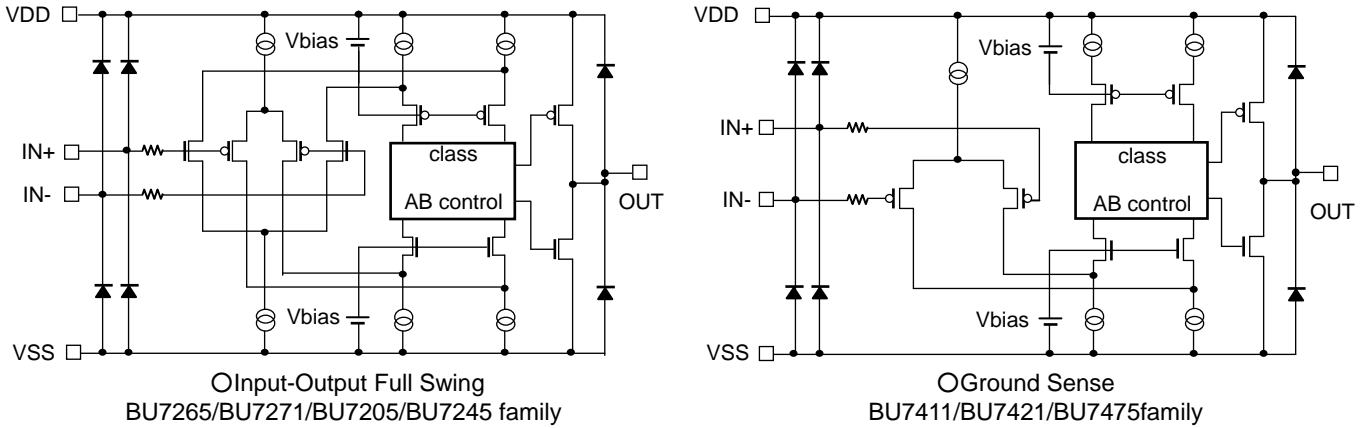

Fig.162 Schematic Diagram

● Test circuit 1 NULL method

VDD, VSS, EK, Vicm Unit:[V]

Parameter	VF	S1	S2	S3	VDD	VSS	EK	Vicm				Calculation	
								BU7265 /BU7271	BU7205 /BU7245	BU7411	BU7421 /BU7475		
Input Offset Voltage	VF1	ON	ON	OFF	3	0	-1.5	3	3	2	1.8	1	
Large Signal Voltage Gain	VF2	ON	ON	ON	3	0	-0.5	1.5	1.5	1	0.9	2	
	VF3						-2.5						
Common-mode Rejection Ratio (Input Common-mode Voltage Range)	VF4	ON	ON	OFF	3	0	-1.5	0	0	0	0	3	
	VF5						-1.5						3
Power Supply Rejection Ratio	VF6	BU7265/BU7271	ON	ON	OFF	1.8	0	-0.9	0	0	0	0	4
		BU7205/BU7245	ON	ON	OFF	1.8							
		BU7421/BU7475	ON	ON	OFF	1.7							
		BU7411	ON	ON	OFF	1.6							
	VF7	ON	ON	OFF	5.5								

— Calculation —

1. Input Offset Voltage (Vio)

$$V_{io} = \frac{|VF1|}{1+R_f/R_s} \text{ [V]}$$

2. Large Signal Voltage Gain (Av)

$$A_v = 20 \text{Log} \frac{2 \times (1+R_f/R_s)}{|VF2-VF3|} \text{ [dB]}$$

3 Common-mode Rejection Ratio (CMRR)

$$\text{CMRR} = 20 \text{Log} \frac{\Delta V_{icm} \times (1+R_f/R_s)}{|VF4-VF5|} \text{ [dB]}$$

4. Power Supply Rejection Ratio (PSRR)

$$\text{PSRR} = 20 \text{Log} \frac{\Delta V_{DD} \times (1+R_f/R_s)}{|VF6-VF7|} \text{ [dB]}$$

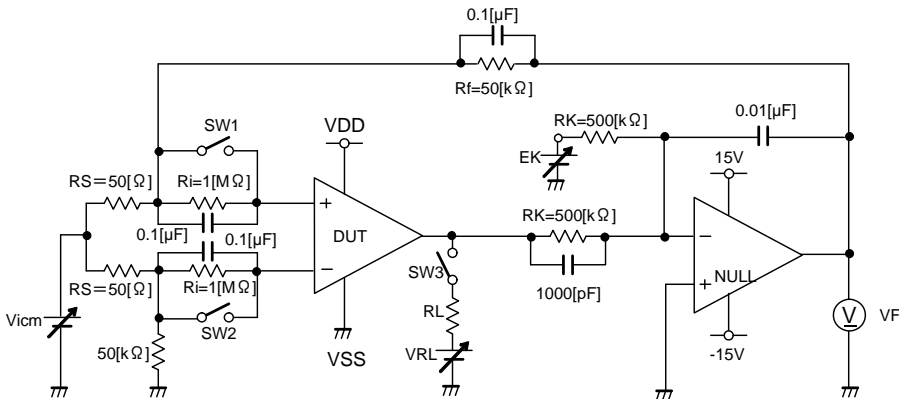

Fig.163 Test circuit 1

● Test circuit 2 switch condition

SW No.	SW 1	SW 2	SW 3	SW 4	SW 5	SW 6	SW 7	SW 8	SW 9	SW 10	SW 11	SW 12
Supply Current	OFF	OFF	ON	OFF	ON	OFF	OFF	OFF	OFF	OFF	OFF	OFF
Maximum Output Voltage (RL=10[kΩ])	OFF	ON	OFF	OFF	ON	OFF	OFF	ON	OFF	OFF	ON	OFF
Output Current	OFF	ON	OFF	OFF	ON	OFF	OFF	OFF	OFF	ON	OFF	OFF
Slew Rate	OFF	OFF	ON	OFF	OFF	OFF	ON	OFF	ON	OFF	OFF	ON
Maximum Frequency	ON	OFF	OFF	ON	ON	OFF	OFF	OFF	ON	OFF	OFF	ON

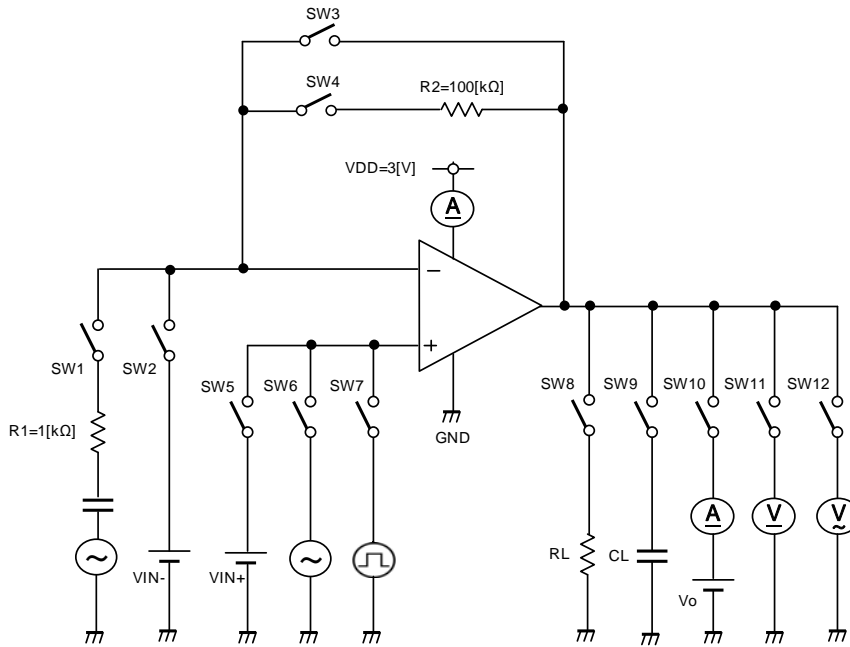

Fig.164 Test circuit 2

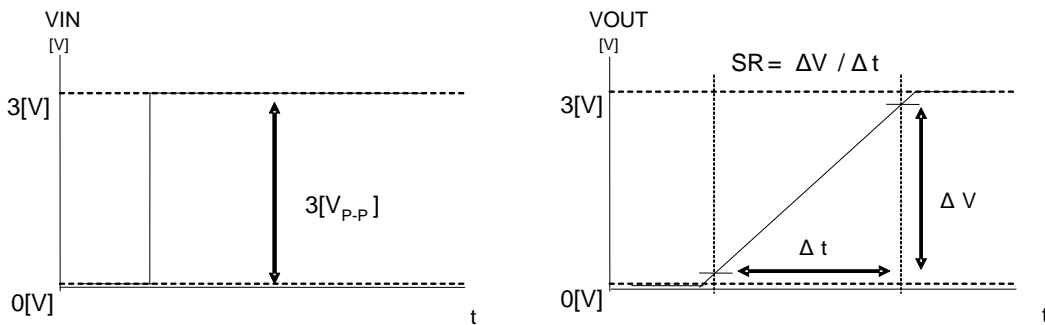

Fig.165 Slew rate input output wave  
(Input-Output Full Swing BU7261/BU7271/BU7205/BU7245 family)

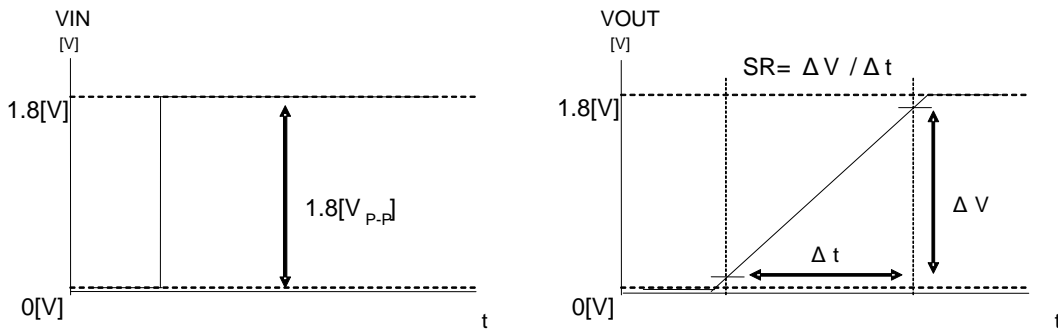

Fig.166 Slew rate input output wave  
(Ground Sense BU7411/BU7421/BU7475 family)

● Examples of circuit  
○ Voltage follower

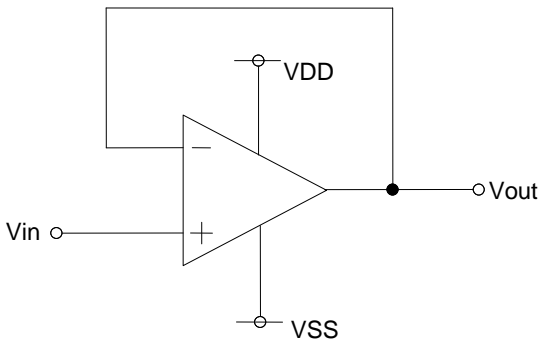

Fig.167 voltage follower circuit

Voltage gain is 0 [dB].

This circuit controls output voltage (Vout) equal input voltage (Vin), and keeps Vout with stable because of high input impedance and low output impedance.

Vout is shown next formula.

$$V_{out} = V_{in}$$

○ Inverting amplifier

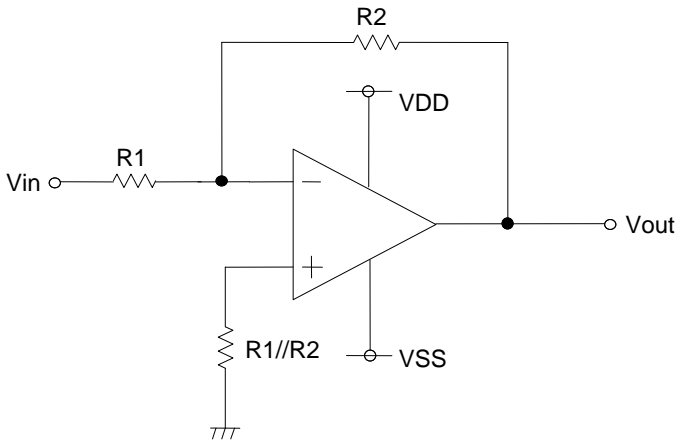

Fig.168 Inverting amplifier circuit

For inverting amplifier, Vin is amplified by voltage gain decided R1 and R2, and phase reversed voltage is outputed. Vout is shown next formula.

$$V_{out} = -(R2/R1) \cdot V_{in}$$

Input impedance is R1.

○ Non-inverting amplifier

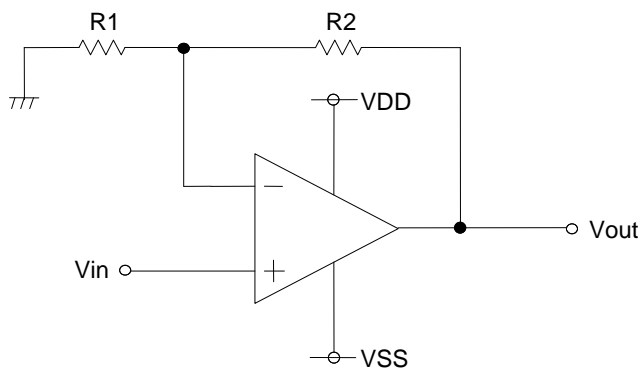

Fig.169 Non-inverting amplifier circuit

For non-inverting amplifier, Vin is amplified by voltage gain decided R1 and R2, and phase is same with Vin. Vout is shown next formula.

$$V_{out} = (1 + R2/R1) \cdot V_{in}$$

This circuit realizes high input impedance because Input impedance is operational amplifier's input Impedance.

● Examples of circuit

○ Adder circuit

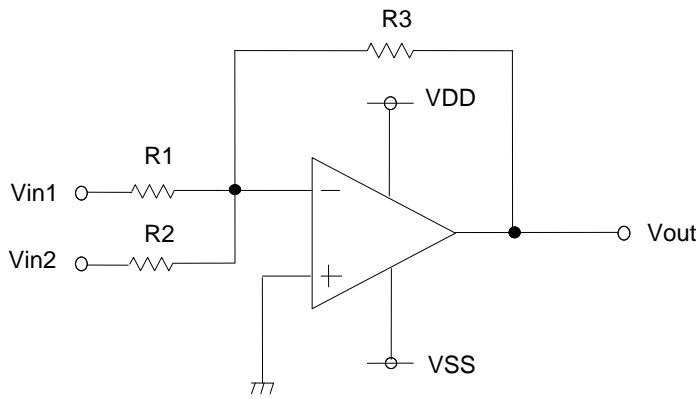

Fig.170 Adder circuit

Adder circuit output the voltage that added up Input voltage. A phase of the output voltage turns over, because non-inverting circuit is used. Vout is shown next formula.

$$V_{out} = -R3(V_{in1}/R1 + V_{in2}/R2)$$

When three input voltage is as above, it connects with input through resistance like R1 and R2.

○ Differential amplifier

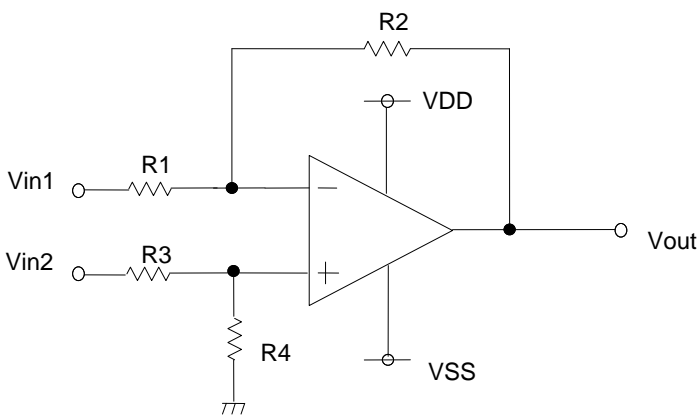

Fig.171 Differential amplifier

Differential amplifier output the voltage that amplified a difference of input voltage. In the case of R1=R3=Ra, R2=R4=Rb Vout is shown next formula.

$$V_{out} = -Rb/Ra(V_{in1} - V_{in2})$$



**● Description of electrical characteristics**

Described here are the terms of electric characteristics used in this technical note. Items and symbols used are also shown. Note that item name and symbol and their meaning may differ from those on another manufacture's document or general document.

**1. Absolute maximum ratings**

Absolute maximum rating item indicates the condition which must not be exceeded. Application of voltage in excess of absolute maximum rating or use out of absolute maximum rated temperature environment may cause deterioration of characteristics

**1.1 Power supply voltage (VDD/VSS)**

Without deterioration or destruction of characteristics of internal circuit.

**1.2 Differential input voltage (V<sub>id</sub>)**

Indicates the maximum voltage that can be applied between non-inverting terminal and inverting terminal without deterioration and destruction of characteristics of IC.

**1.3 Input common-mode voltage range (V<sub>icm</sub>)**

Indicates the maximum voltage that can be applied to non-inverting terminal and inverting terminal without deterioration or destruction of characteristics. Input common-mode voltage range of the maximum ratings not assure normal operation of IC. When normal operation of IC is desired, the input common-mode voltage of characteristics item must be followed.

**1.4 Power dissipation (P<sub>d</sub>)**

Indicates the power that can be consumed by specified mounted board at the ambient temperature 25°C (normal temperature). As for package product, P<sub>d</sub> is determined by the temperature that can be permitted by IC chip in the package (maximum junction temperature) and thermal resistance of the package.

**2. Electrical characteristics item****2.1 Input offset voltage (V<sub>io</sub>)**

Indicates the voltage difference between non-inverting terminal and inverting terminal. It can be translated into the input voltage difference required for setting the output voltage at 0 [V].

**2.2 Input offset current (I<sub>io</sub>)**

Indicates the difference of input bias current between non-inverting terminal and inverting terminal.

**2.3 Input bias current (I<sub>b</sub>)**

Indicates the current that flows into or out of the input terminal. It is defined by the average of input bias current at non-inverting terminal and input bias current at inverting terminal.

**2.4 Circuit current (I<sub>DD</sub>)**

Indicates the IC current that flows under specified conditions and no-load steady status.

**2.5 High level output voltage / Low level output voltage (V<sub>OM</sub>)**

Indicates the voltage range that can be output by the IC under specified load condition. It is typically divided into high-level output voltage and low-level output voltage. High-level output voltage indicates the upper limit of output voltage. Low-level output voltage indicates the lower limit.

**2.6 Large signal voltage gain (A<sub>v</sub>)**

Indicates the amplifying rate (gain) of output voltage against the voltage difference between non-inverting terminal and inverting terminal. It is normally the amplifying rate (gain) with reference to DC voltage.

$$A_v = (\text{Output voltage fluctuation}) / (\text{Input offset fluctuation})$$

**2.7 Input common-mode voltage range (V<sub>icm</sub>)**

Indicates the input voltage range where IC operates normally.

**2.8 Common-mode rejection ratio (CMRR)**

Indicates the ratio of fluctuation of input offset voltage when in-phase input voltage is changed. It is normally the fluctuation of DC.

$$\text{CMRR} = (\text{Change of Input common-mode voltage}) / (\text{Input offset fluctuation})$$

**2.9 Power supply rejection ratio (PSRR)**

Indicates the ratio of fluctuation of input offset voltage when supply voltage is changed. It is normally the fluctuation of DC.

$$\text{PSRR} = (\text{Change of power supply voltage}) / (\text{Input offset fluctuation})$$

**2.10 Channel separation (CS)**

Indicates the fluctuation of input offset voltage or that of output voltage with reference to the change of output voltage of driven channel.

**2.11 Slew rate (SR)**

Indicates the time fluctuation ratio of voltage output when step input signal is applied.

**2.12 Unity gain frequency (f<sub>t</sub>)**

Indicates a frequency where the voltage gain of Op-Amp is 1.

**2.13 Total harmonic distortion + Noise (THD+N)**

Indicates the fluctuation of input offset voltage or that of output voltage with reference to the change of output voltage of driven channel.

**2.14 Input referred noise voltage (V<sub>n</sub>)**

Indicates a noise voltage generated inside the operational amplifier equivalent by ideal voltage source connected in series with input terminal.

● Derating Curve

Power dissipation (total loss) indicates the power that can be consumed by IC at Ta=25°C (normal temperature). IC is heated when it consumes power, and the temperature of IC chip becomes higher than ambient temperature. The temperature that can be accepted by IC chip depends on circuit configuration, manufacturing process, and consumable power is limited. Power dissipation is determined by the temperature allowed in IC chip (maximum junction temperature) and thermal resistance of package (heat dissipation capability). The maximum junction temperature is typically equal to the maximum value in the storage temperature range. Heat generated by consumed power of IC radiates from the mold resin or lead frame of the package. The parameter which indicates this heat dissipation capability (hardness of heat release) is called thermal resistance, represented by the symbol  $\theta_{j-a}$  [°C/W]. The temperature of IC inside the package can be estimated by this thermal resistance. Fig.172 (a) shows the model of thermal resistance of the package. Thermal resistance  $\theta_{ja}$ , ambient temperature Ta, junction temperature Tj, and power dissipation Pd can be calculated by the equation below:

$$\theta_{ja} = (T_j - T_a) / P_d \quad [^{\circ}\text{C}/\text{W}] \quad \dots \dots \quad (I)$$

Derating curve in Fig.172 (b) indicates power that can be consumed by IC with reference to ambient temperature. Power that can be consumed by IC begins to attenuate at certain ambient temperature. This gradient is determined by thermal resistance  $\theta_{ja}$ . Thermal resistance  $\theta_{ja}$  depends on chip size, power consumption, package, ambient temperature, package condition, wind velocity, etc even when the same of package is used. Thermal reduction curve indicates a reference value measured at a specified condition. Fig.173(c)-(d) show a derating curve for an example of BU7265 / BU7205 / BU7271 / BU7245 / BU7411 / BU7421 / BU7475 family.

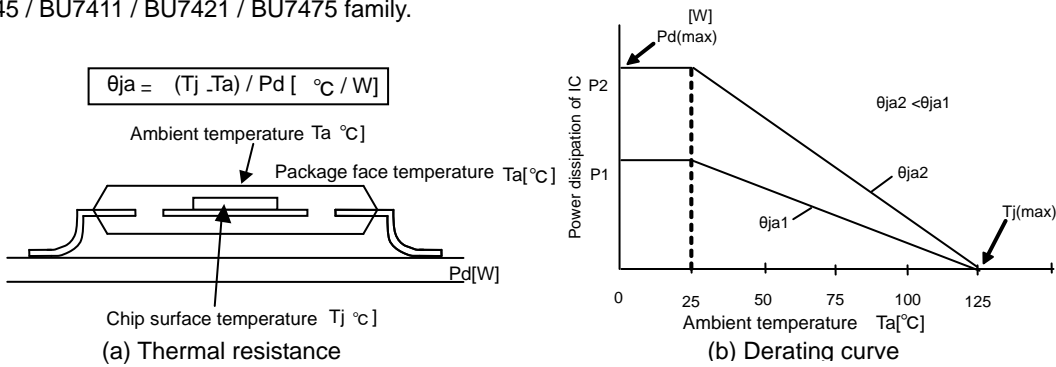
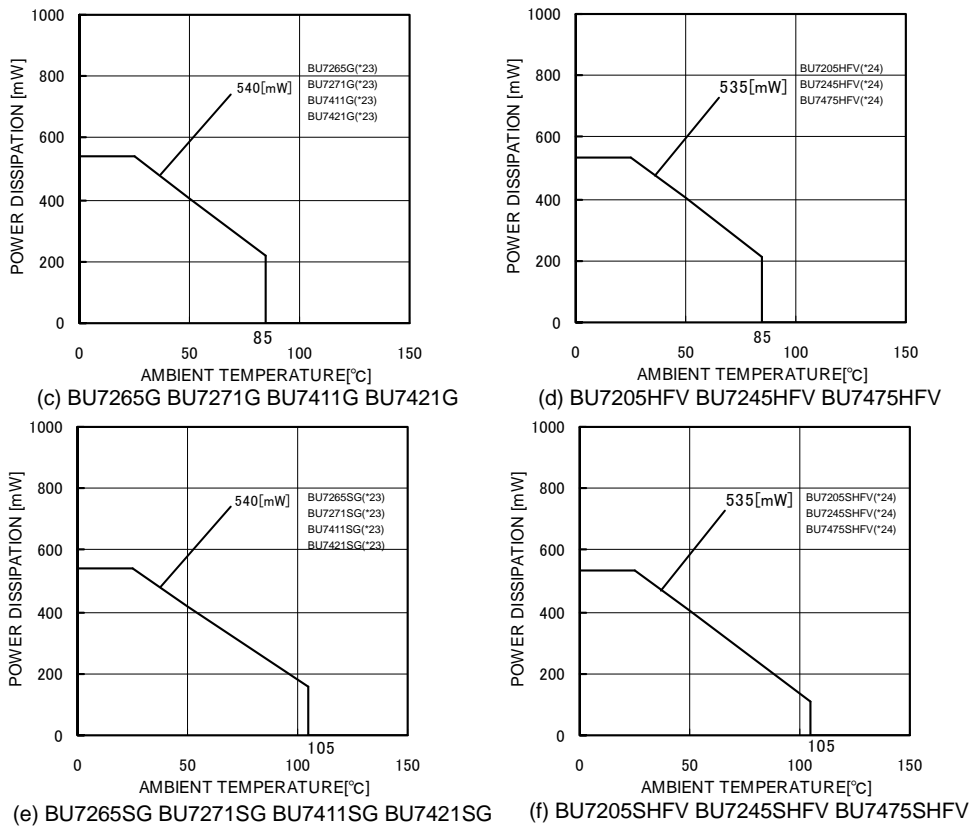

Fig.172 Thermal resistance and derating



(*23)	(*24)	Unit
5.4	5.35	[mW/°C]

When using the unit above Ta=25[°C], subtract the value above per degree[°C]. Permissible dissipation is the value when FR4 glass epoxy board 70[mm] × 70[mm] × 1.6[mm] (copper foil area below 3[%]) is mounted

Fig.173 Derating Curve

## ● Notes for Use

- 1) Absolute maximum ratings  
Absolute maximum ratings are the values which indicate the limits, within which the given voltage range can be safely charged to the terminal. However, it does not guarantee the circuit operation.
- 2) Applied voltage to the input terminal  
For normal circuit operation of voltage comparator, please input voltage for its input terminal within input common mode voltage  $VDD+0.3[V]$ . Then, regardless of power supply voltage,  $VSS-0.3[V]$  can be applied to input terminals without deterioration or destruction of its characteristics.
- 3) Operating power supply (split power supply/single power supply)  
The operational amplifier operates if a given level of voltage is applied between VDD and VSS. Therefore, the operational amplifier can be operated under single power supply or split power supply.
- 4) Power dissipation (Pd)  
If the IC is used under excessive power dissipation. An increase in the chip temperature will cause deterioration of the radical characteristics of IC. For example, reduction of current capability. Take consideration of the effective power dissipation and thermal design with a sufficient margin. Pd is reference to the provided power dissipation curve.
- 5) Short circuits between pins and incorrect mounting  
Short circuits between pins and incorrect mounting when mounting the IC on a printed circuit board, take notice of the direction and positioning of the IC. If IC is mounted erroneously, it may be damaged. Also, when a foreign object is inserted between output, between output and VDD terminal or VSS terminal which causes short circuit, the IC may be damaged.
- 6) Output short circuit  
If short circuit occurs between the output terminal and VDD terminal, excessive output current may flow and generate heat, causing destruction of the IC. Take due care.
- 7) Using under strong electromagnetic field  
Be careful when using the IC under strong electromagnetic field because it may malfunction.
- 8) Usage of IC  
When stress is applied to the IC through warp of the printed circuit board, the characteristics may fluctuate due to the piezo effect. Be careful of the warp of the printed circuit board.
- 9) Testing IC on the set board  
When testing IC on the set board, in cases where the capacitor is connected to the low impedance, make sure to discharge per fabrication because there is a possibility that IC may be damaged by stress. When removing IC from the set board, it is essential to cut supply voltage. As a countermeasure against the static electricity, observe proper grounding during fabrication process and take due care when carrying and storage it.
- 10) The IC destruction caused by capacitive load  
The transistors in circuits may be damaged when VDD terminal and VSS terminal is shorted with the charged output terminal capacitor. When IC is used as an operational amplifier or as an application circuit, where oscillation is not activated by an output capacitor, the output capacitor must be kept below  $0.1[\mu F]$  in order to prevent the damage mentioned above.
- 11) Decoupling capacitor  
Insert the decoupling capacitance between VDD and VSS, for stable operation of operational amplifier.
- 12) Latch up  
Be careful of input voltage that exceed the VDD and VSS. When CMOS device have sometimes occur latch up operation. And protect the IC from abnormal noise.
- 13) Crossover distortion  
Inverting amplifier generates crossover distortion when feedback resistance value is small. To suppress the crossover distortion, connect a resistor between the output terminal and VSS. Then increase the bias current to enable class A output stage operation.

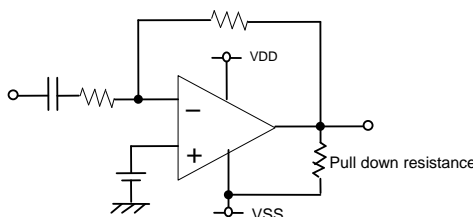
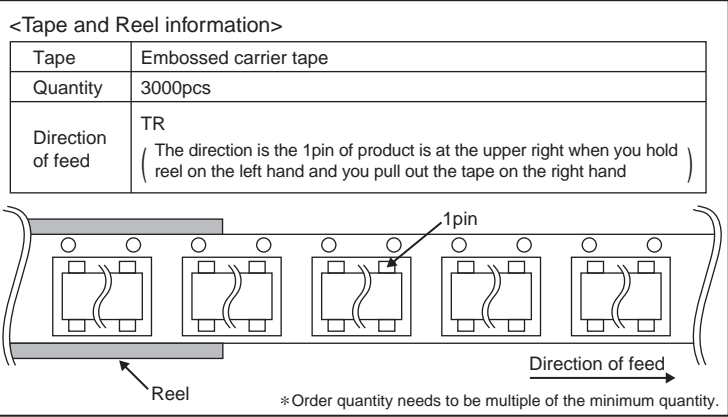
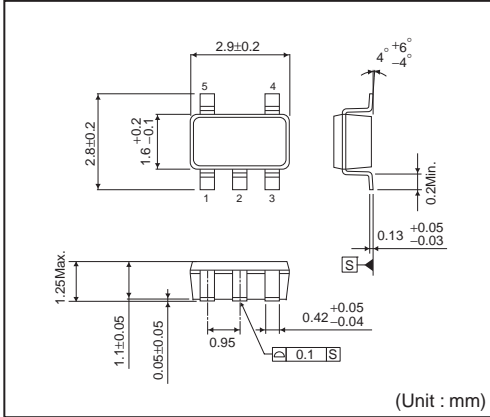

Fig.174 Pull down resistance

● Ordering Part Number

B	U		7	2	6	5	S		H	F	V	-	T	R
Part No. BU		Part No. • 7265 7265S    • 7411 7411S • 7271 7271S    • 7421 7421S • 7205 7205S    • 7475 7475S • 7245 7245S						Package G :SSOP5 HFV :HVSOF5			Packaging and forming specification TR: Embossed tape and reel			

SSOP5



HVSOF5

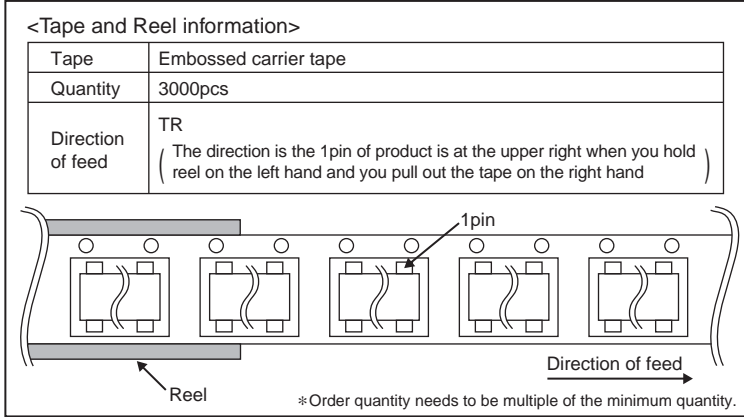
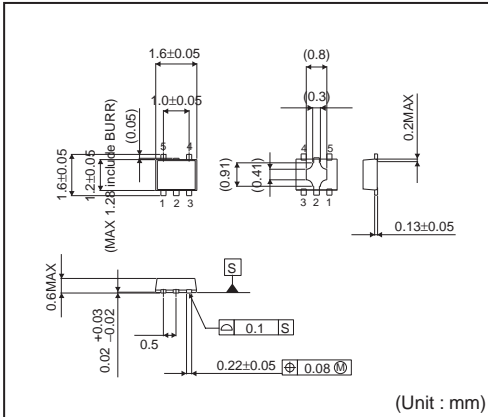

## Notes

No copying or reproduction of this document, in part or in whole, is permitted without the consent of ROHM Co.,Ltd.

The content specified herein is subject to change for improvement without notice.

The content specified herein is for the purpose of introducing ROHM's products (hereinafter "Products"). If you wish to use any such Product, please be sure to refer to the specifications, which can be obtained from ROHM upon request.

Examples of application circuits, circuit constants and any other information contained herein illustrate the standard usage and operations of the Products. The peripheral conditions must be taken into account when designing circuits for mass production.

Great care was taken in ensuring the accuracy of the information specified in this document. However, should you incur any damage arising from any inaccuracy or misprint of such information, ROHM shall bear no responsibility for such damage.

The technical information specified herein is intended only to show the typical functions of and examples of application circuits for the Products. ROHM does not grant you, explicitly or implicitly, any license to use or exercise intellectual property or other rights held by ROHM and other parties. ROHM shall bear no responsibility whatsoever for any dispute arising from the use of such technical information.

The Products specified in this document are intended to be used with general-use electronic equipment or devices (such as audio visual equipment, office-automation equipment, communication devices, electronic appliances and amusement devices).

The Products specified in this document are not designed to be radiation tolerant.

While ROHM always makes efforts to enhance the quality and reliability of its Products, a Product may fail or malfunction for a variety of reasons.

Please be sure to implement in your equipment using the Products safety measures to guard against the possibility of physical injury, fire or any other damage caused in the event of the failure of any Product, such as derating, redundancy, fire control and fail-safe designs. ROHM shall bear no responsibility whatsoever for your use of any Product outside of the prescribed scope or not in accordance with the instruction manual.

The Products are not designed or manufactured to be used with any equipment, device or system which requires an extremely high level of reliability the failure or malfunction of which may result in a direct threat to human life or create a risk of human injury (such as a medical instrument, transportation equipment, aerospace machinery, nuclear-reactor controller, fuel-controller or other safety device). ROHM shall bear no responsibility in any way for use of any of the Products for the above special purposes. If a Product is intended to be used for any such special purpose, please contact a ROHM sales representative before purchasing.

If you intend to export or ship overseas any Product or technology specified herein that may be controlled under the Foreign Exchange and the Foreign Trade Law, you will be required to obtain a license or permit under the Law.



Thank you for your accessing to ROHM product informations.  
More detail product informations and catalogs are available, please contact us.

## ROHM Customer Support System

<http://www.rohm.com/contact/>



Компания «ЭлектроПласт» предлагает заключение долгосрочных отношений при поставках импортных электронных компонентов на взаимовыгодных условиях!

Наши преимущества:

- Оперативные поставки широкого спектра электронных компонентов отечественного и импортного производства напрямую от производителей и с крупнейших мировых складов;
- Поставка более 17-ти миллионов наименований электронных компонентов;
- Поставка сложных, дефицитных, либо снятых с производства позиций;
- Оперативные сроки поставки под заказ (от 5 рабочих дней);
- Экспресс доставка в любую точку России;
- Техническая поддержка проекта, помощь в подборе аналогов, поставка прототипов;
- Система менеджмента качества сертифицирована по Международному стандарту ISO 9001;
- Лицензия ФСБ на осуществление работ с использованием сведений, составляющих государственную тайну;
- Поставка специализированных компонентов (Xilinx, Altera, Analog Devices, Intersil, Interpoint, Microsemi, Aeroflex, Peregrine, Syfer, Eurofarad, Texas Instrument, Miteq, Cobham, E2V, MA-COM, Hittite, Mini-Circuits, General Dynamics и др.);

Помимо этого, одним из направлений компании «ЭлектроПласт» является направление «Источники питания». Мы предлагаем Вам помощь Конструкторского отдела:

- Подбор оптимального решения, техническое обоснование при выборе компонента;
- Подбор аналогов;
- Консультации по применению компонента;
- Поставка образцов и прототипов;
- Техническая поддержка проекта;
- Защита от снятия компонента с производства.



#### Как с нами связаться

**Телефон:** 8 (812) 309 58 32 (многоканальный)

**Факс:** 8 (812) 320-02-42

**Электронная почта:** [org@eplast1.ru](mailto:org@eplast1.ru)

**Адрес:** 198099, г. Санкт-Петербург, ул. Калинина, дом 2, корпус 4, литера А.