

IEC Appliance Inlet C14 with Fuseholder 1- or 2-pole



Snap-in version



See below:  
[Approvals and Compliances](#)

**Description**

- Panel mount :  
 Snap-in version from front side
- 2 Functions :  
 Appliance Inlet protection class I or II , Fuseholder for fuse-links 5 x 20 mm on the rear-side 1- or 2-pole
- Meets the requirements of IEC 60335-1 for appliances in unattended use. This includes the enhanced requirements of glow wire tests acc. to IEC 60695-2-11 or -12 &-13.

**Characteristics**

- Two "locking" snappers reinforce connector against repeated or excessive pull out force during plug removal
- All single elements are already wired
- Fuseholder on the inside of the equipment prevents accidental use of incorrect fuse-links by the user
- Suitable for use in equipment according to IEC/UL 62368-1

**Other versions on request**

- Ground terminal, solder/quick-connect, 90° to connector axis

**Weblinks**

[pdf data sheet](#), [html datasheet](#), [General Product Information](#), [Approvals](#), [Distributor-Stock-Check](#), [Accessories](#), [Detailed request for product](#), [Landing Page](#)

Newly available variants corresponding to V-Lock mating cordset. The connector is equipped with a notch intended for use with the latching cordset. The cord latching system prevents against accidental removal of the cordset.

**Technical Data**

Ratings IEC	10A / 250VAC; 50Hz	Appliance inlet/-outlet	C14 / C18 acc. to IEC 60320-1, UL 498, CSA C22.2 no. 42 (for cold conditions) pin-temperature 70 °C, 10A, Protection Class I or II
Ratings UL/CSA	10A / 125VAC; 60Hz	Fuseholder	1 or 2 pole, Shocksafe category PC2 acc. to IEC 60127-6, for fuse-links 5 x 20mm
Dielectric Strength	> 2.2kVAC between L-N > 3kVAC between L/N-PE (1 min/50Hz)	Rated Power Acceptance @ Ta 23 °C	5 x 20: 3.15W (1 pole)/ 2.5W (2-pole) <u>per pole</u>
Allowable Operation Temperature	-25 °C to 70 °C	Power Acceptance @ Ta > 23°C	Admissible power acceptance at higher ambient temperature see derating curves
IP-Protection	from front side IP40 acc. to IEC 60529	Terminal	Quick connect terminals 4.8 x 0.8 mm , Ground terminal: Solder terminals or quick connect terminals tin-plated Solder terminal on request
Protection against electric shock	Suitable for appliances with protection class I or II acc. to IEC 61140	Panel Thickness S	Snap-in: 1/1.2/1.5/2/2.5/3 mm (other on request) (all steps with one variant)
Material: Housing	Thermoplastic, black, UL 94V-0		

**Approvals and Compliances**



Detailed information on product approvals, code requirements, usage instructions and detailed test conditions can be looked up in [Details about Approvals](#)

SCHURTER products are designed for use in industrial environments. They have approvals from independent testing bodies according to national and international standards. Products with specific characteristics and requirements such as required in the automotive sector according to IATF 16949, medical technology according to ISO 13485 or in the aerospace industry can be offered exclusively with customer-specific, individual agreements by SCHURTER.

## Approvals





The approval mark is used by the testing authorities to certify compliance with the safety requirements placed on electronic products.

Approval Reference Type: GSF2

Approval Logo	Certificates	Certification Body	Description
	<a href="#">VDE Approvals</a>	VDE	Certificate Number: 40024857
	<a href="#">UL Approvals</a>	UL	UL File Number: E93617, E96454
	<a href="#">CCC Approvals</a>	CCC	CCC Certificate Number: 2006010204183182



## Product standards

Product standards that are referenced

Organization	Design	Standard	Description
	Designed according to	IEC 60320-1	Appliance couplers for household and similar general purposes
	Designed according to	IEC 60127-6	Miniature fuses. Part 6. Fuse-holders for miniature fuse-links
	Designed according to	IEC 61058-1	Switches for appliances. Part 1. General requirements
	Designed according to	UL 498	Standard for Attachment Plugs and Receptacles
	Designed according to	CSA C22.2 no. 42	General Use Receptacles, Attachment Plugs, and Similar Wiring Devices







## Application standards

Application standards where the product can be used

Organization	Design	Standard	Description
	Designed for applications acc.	IEC/UL 62368-1	IEC 62368-1 includes the basic requirements for safety of audio, video, information technology and office equipment.
	Designed for applications acc.	IEC 60335-1	Safety of electrical appliances for household and similar purposes. Meets the requirements for appliances in unattended use. This includes the enhanced requirements of glow wire tests acc. to IEC 60695-2-11 or -12 & -13.

## Compliances

The product complies with following Guide Lines

Identification	Details	Initiator	Description
	<a href="#">CE declaration of conformity</a>	SCHURTER AG	The CE marking declares that the product complies with the applicable requirements laid down in the harmonisation of Community legislation on its affixing in accordance with EU Regulation 765/2008.
	RoHS	SCHURTER AG	Directive RoHS 2011/65/EU, Amendment (EU) 2015/863
	China RoHS	SCHURTER AG	The law SJ / T 11363-2006 (China RoHS) has been in force since 1 March 2007. It is similar to the EU directive RoHS.
	REACH	SCHURTER AG	On 1 June 2007, Regulation (EC) No 1907/2006 on the Registration, Evaluation, Authorization and Restriction of Chemicals 1 (abbreviated as "REACH") entered into force.
	<a href="#">Landing Page V-Lock</a>	SCHURTER AG	V-Lock system are based on a matching plug-dose combination. The connector is equipped with a notch intended for use with the latching cordset. The cord latching system prevents against accidental removal of the cordset.
	<a href="#">White Paper Glow wire test</a>	SCHURTER AG	Meets the requirements of IEC 60335-1 for appliances in unattended use. This includes the enhanced requirements of glow wire tests acc. to IEC 60695-2-11 or -12 & -13.

Dimensions [mm]

punched / drilled

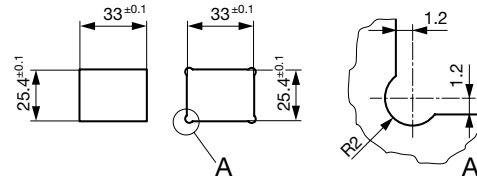
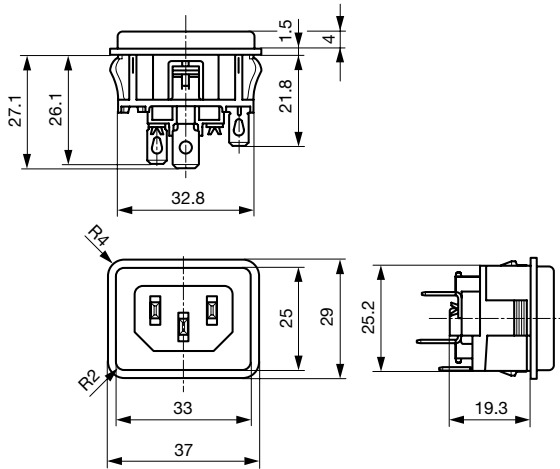

Line and neutral: Quick-connect  
 Quick connect terminal 4.8 x 0.8  
 mm

Ground terminal  
 Quick connect terminal 4.8 x 0.8  
 mm

Ground terminal: Quick-connect  
 Quick connect terminal 6.3 x 0.8  
 mm

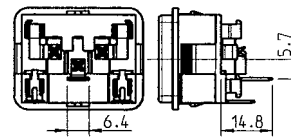
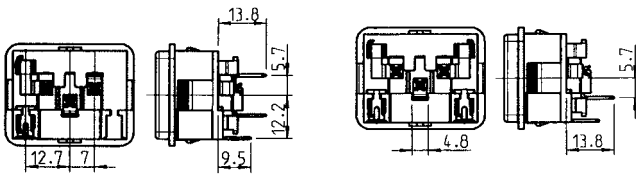

Assembly Instructions

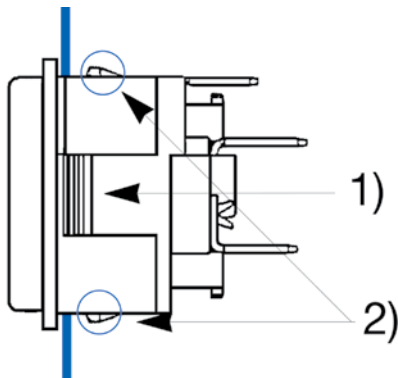

- 1) Main snappers for snap-in mounting
- 2) Additional safety snappers not in use

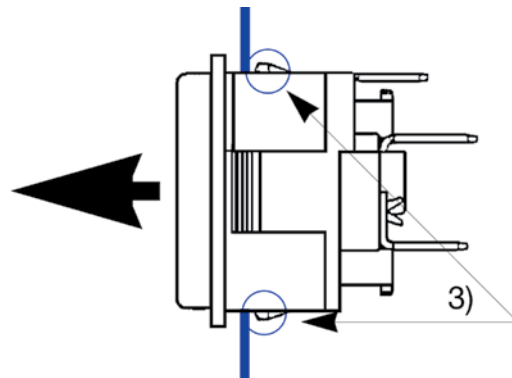

- 3) Additional safety snappers in use  
 against excessive pull out force

Derating Curves

1-pole

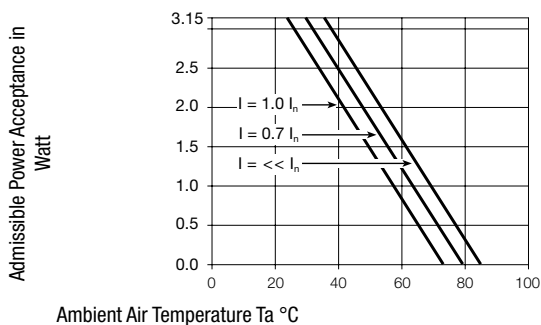

2-pole

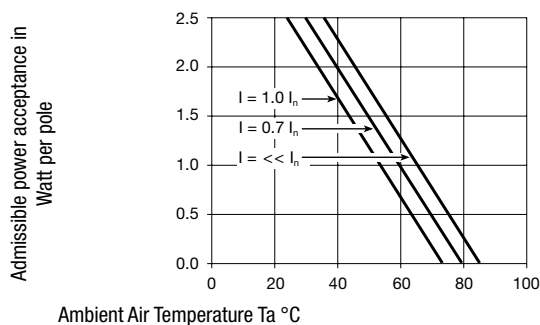

All Variants

Protection Class	Fuseholder	Terminals L / N		Ground terminal		V-Lock	Order Number
		connection type	Terminal direction	connection type	Terminal direction		
I	-	Quick connect terminals 4.8 x 0.8 mm	straight	Quick connect terminals 4.8 x 0.8 mm	straight		GSF2.0011.01
I	1-pole	Quick connect terminals 4.8 x 0.8 mm	90° to connector axis	Quick connect terminals 4.8 x 0.8 mm	90° to connector axis		GSF2.1022.01
I	1-pole	Quick connect terminals 4.8 x 0.8 mm	straight	Quick connect terminals 4.8 x 0.8 mm	straight		GSF2.1011.01
I	1-pole	Quick connect terminals 4.8 x 0.8 mm	straight	Quick connect terminals 6.3 x 0.8 mm	straight		GSF2.1013.01
I	2-pole	Quick connect terminals 4.8 x 0.8 mm	90° to connector axis	Quick connect terminals 4.8 x 0.8 mm	90° to connector axis		GSF2.2022.01
I	2-pole	Quick connect terminals 4.8 x 0.8 mm	straight	Quick connect terminals 4.8 x 0.8 mm	straight		GSF2.2011.01
I	2-pole	Quick connect terminals 4.8 x 0.8 mm	straight	Quick connect terminals 6.3 x 0.8 mm	straight		GSF2.2013.01
II	1-pole	Quick connect terminals 4.8 x 0.8 mm	straight	-	-		GSF2.1010.01
II	2-pole	Quick connect terminals 4.8 x 0.8 mm	straight	-	-		GSF2.2010.01

Most Popular.

Availability for all products can be searched real-time: <https://www.schurter.com/en/Stock-Check/Stock-Check-SCHURTER>

Packaging unit 50 Pcs

Mating Outlets/Connectors

Category / Description

[Connector Overview complete](#)



4782 Mounting: Power Cord, 3 x 1 mm <sup>2</sup> / 3 x 18 AWG, Cable, Connector: IEC C13	4782
4785 Mounting: Power Cord, 3 x 1 mm <sup>2</sup> / 3 x 18 AWG, Cable, Connector: IEC C13	4785
4012 Mounting: Power Supply Cord, 3 x 1 mm <sup>2</sup> , Screw clamps, Connector: IEC C13	4012
4300-06 Mounting: Power Cord, 3 x 1 mm <sup>2</sup> / 3 x 18 AWG, Cable, Connector: IEC C13	4300-06
4781 Mounting: Power Cord, 3 x 1 mm <sup>2</sup> / 3 x 18 AWG, Cable, Connector: IEC C15	4781

[Connector further types to GSF2](#)

...



[Interconnection Cord Overview complete](#)

Cord Sets 10 A, Interconnection, 2.0 m, IEC H05VV-F3G1.0, black	6007.0204
Cord Sets 10 A, Interconnection, 1.0 m, Connector IEC C13, H05VV-F3G1.0, black	6007.0212
Cord Sets 10 A, Interconnection, 2.0 m, Connector IEC C13, H05VV-F3G1.0, black	6007.0214

[Interconnection Cord further types to GSF2](#)



[Power Supply Cord Overview complete](#)

Cord Sets 10 A, Europlug, 2.5 m, Connector IEC C13, H05VV-F3G1.0, black	6004.0215
Cord Sets 10 A, Europlug, 2.5 m, Connector IEC C13, H05VV-F3G1.0, black	6003.0215
Cord Sets 10 A, uninsulated wires, 2.0 m, Connector IEC C13, H05VV-F3G1.0, black	6000.0224
Cord Sets 10 A, uninsulated wires, 2.0 m, Connector IEC C13, H05VV-F3G1.0, black	6000.0214
Cord Sets 10 A, United Kingdom, 2.5 m, Connector IEC C13, H05VV-F3G1.0, black	6044.0215

[Power Supply Cord further types to GSF2](#)

...



[Power Supply or Interconnection Cord Overview complete](#)

Cord Sets 10 A, United Kingdom, 2.0 m, Connector IEC H05VV-F3G1.0, black	6044.0204
--	-----------

[Power Supply or Interconnection Cord further types to GSF2](#)

**Mating Outlets/Connectors shuttered**



[Connector Overview complete](#)

4783 Mounting: Power Cord, 3 x 1 mm <sup>2</sup> / 3 x 18 AWG, Cable, Connector: IEC C13	4783
--	------

[Connector further types to GSF2](#)



[Power Cord Overview complete](#)

VAC13KS, Overview, V-Lock cord retaining, diverse Connector IEC C13, diverse, black	VAC13KS
VAC17KS, V-Lock cord retaining, diverse m, Connector IEC C17, diverse, black / grey / white	VAC17KS

[Power Cord further types to GSF2](#)



Компания «ЭлектроПласт» предлагает заключение долгосрочных отношений при поставках импортных электронных компонентов на взаимовыгодных условиях!

Наши преимущества:

- Оперативные поставки широкого спектра электронных компонентов отечественного и импортного производства напрямую от производителей и с крупнейших мировых складов;
- Поставка более 17-ти миллионов наименований электронных компонентов;
- Поставка сложных, дефицитных, либо снятых с производства позиций;
- Оперативные сроки поставки под заказ (от 5 рабочих дней);
- Экспресс доставка в любую точку России;
- Техническая поддержка проекта, помощь в подборе аналогов, поставка прототипов;
- Система менеджмента качества сертифицирована по Международному стандарту ISO 9001;
- Лицензия ФСБ на осуществление работ с использованием сведений, составляющих государственную тайну;
- Поставка специализированных компонентов (Xilinx, Altera, Analog Devices, Intersil, Interpoint, Microsemi, Aeroflex, Peregrine, Syfer, Eurofarad, Texas Instrument, Miteq, Cobham, E2V, MA-COM, Hittite, Mini-Circuits, General Dynamics и др.);

Помимо этого, одним из направлений компании «ЭлектроПласт» является направление «Источники питания». Мы предлагаем Вам помощь Конструкторского отдела:

- Подбор оптимального решения, техническое обоснование при выборе компонента;
- Подбор аналогов;
- Консультации по применению компонента;
- Поставка образцов и прототипов;
- Техническая поддержка проекта;
- Защита от снятия компонента с производства.



#### Как с нами связаться

**Телефон:** 8 (812) 309 58 32 (многоканальный)

**Факс:** 8 (812) 320-02-42

**Электронная почта:** [org@eplast1.ru](mailto:org@eplast1.ru)

**Адрес:** 198099, г. Санкт-Петербург, ул. Калинина, дом 2, корпус 4, литера А.