

Automotive-grade 400 V internally clamped IGBT E_{SCIS} 320 mJ

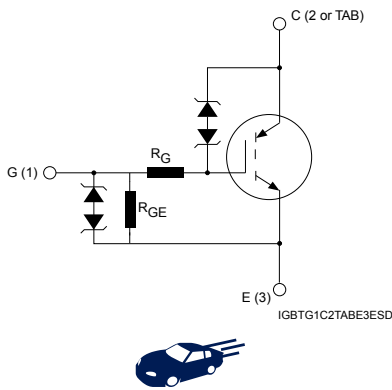
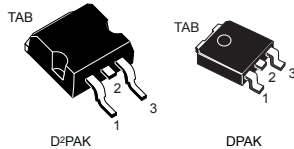

Features

- AEC-Q101 qualified
- SCIS energy of 320 mJ @ T_J = 25 °C
- Parts are 100% tested in SCIS
- ESD gate-emitter protection
- Gate-collector high voltage clamping
- Logic level gate drive
- Very low saturation voltage
- High pulsed current capability
- Gate and gate-emitter resistor

Applications

- Automotive ignition coil driver circuit

Description

This application-specific IGBT utilizes the most advanced PowerMESH™ technology optimized for coil driving in the harsh environment of automotive ignition systems. These devices show very low on-state voltage and very high SCIS energy capability over a wide operating temperature range. Moreover, ESD-protected logic level gate input and an integrated gate resistor means no external protection circuitry is required.

Product status	
	STGB25N40LZAG
	STGD25N40LZAG
Product summary	
Order code	STGB25N40LZAG
Marking	GB25N40LZ
Package	D²PAK
Packing	Tape and reel
Order code	STGD25N40LZAG
Marking	GD25N40LZ
Package	DPAK
Packing	Tape and reel

1 Electrical ratings

Table 1. Absolute maximum ratings

Symbol	Parameter	Value	Unit
V_{CES}	Collector-emitter voltage ($V_{GE} = 0\text{ V}$)	$V_{CES(\text{clamped})}$	V
V_{ECS}	Emitter-collector voltage ($V_{GE} = 0\text{ V}$)	20	V
I_C	Continuous collector current at $T_C = 25\text{ °C}$, $V_{GE} = 4\text{ V}$	25	A
	Continuous collector current at $T_C = 100\text{ °C}$, $V_{GE} = 4\text{ V}$	25	A
$I_{CP}^{(1)}$	Pulsed collector current	50	A
V_{GE}	Gate-emitter voltage	$V_{GE(\text{clamped})}$	V
P_{TOT}	Total dissipation at $T_C = 25\text{ °C}$	150	W
$E_{SCIS_{25}}^{(2)}$	Self clamping inductive switching energy	320	mJ
$E_{SCIS_{150}}^{(3)}$	Self clamping inductive switching energy @ $T_J = 150\text{ °C}$	180	mJ
ESD	Human body model, $R = 1.5\text{ k}\Omega$, $C = 100\text{ pF}$	4	kV
	Charged device model	2	kV
T_{STG}	Storage temperature range	- 55 to 175	°C
T_J	Operating junction temperature range		

1. Pulse width limited by maximum junction temperature.
2. Starting $T_J = 25\text{ °C}$, $L = 3\text{ mH}$, $R_g = 1\text{ k}\Omega$, $V_{cc} = 50\text{ V}$ during inductor charging and $V_{cc} = 0\text{ V}$ during the time in clamp. Parts are 100% electrically tested in production.
3. Starting $T_J = 150\text{ °C}$, $L = 3\text{ mH}$, $R_g = 1\text{ k}\Omega$, $V_{cc} = 50\text{ V}$ during inductor charging and $V_{cc} = 0\text{ V}$ during the time in clamp.

Table 2. Thermal data

Symbol	Parameter	Value		Unit
		D ² PAK	DPAK	
$R_{thj\text{-case}}$	Thermal resistance junction-case	1		°C/W
$R_{thj\text{-amb}}$	Thermal resistance junction-ambient	62.5	100	°C/W

2 Electrical characteristics

$T_C = 25\text{ °C}$ unless otherwise specified

Table 3. Static characteristics

Symbol	Parameter	Test conditions	Min.	Typ.	Max.	Unit
$V_{CES(\text{clamped})}$	Collector-emitter clamped voltage	$I_C = 2\text{ mA}, V_{GE} = 0\text{ V}$		400		V
		$I_C = 2\text{ mA}, V_{GE} = 0\text{ V}, T_J = -40\text{ °C to }175\text{ °C}$	375		435	V
$V_{(BR)ECS}$	Emitter-collector break-down voltage	$I_C = 75\text{ mA}, V_{GE} = 0\text{ V}$	20			V
$V_{GE(\text{clamped})}$	Gate-emitter clamped voltage	$I_G = \pm 2\text{ mA}, T_J = -40\text{ °C to }175\text{ °C}$	12		16	V
$V_{CE(\text{sat})}$	Collector-emitter saturation voltage	$V_{GE} = 4\text{ V}, I_C = 6\text{ A}$		1.1	1.25	V
		$V_{GE} = 4.5\text{ V}, I_C = 10\text{ A}, T_J = 175\text{ °C}$		1.25	1.55	V
$V_{GE(\text{th})}$	Gate-threshold voltage	$V_{GE} = V_{CE}, I_C = 1\text{ mA}$	1.3	1.7	2.1	V
		$V_{GE} = V_{CE}, I_C = 1\text{ mA}, T_J = 175\text{ °C}$		1.05		V
I_{CES}	Collector cut-off current	$V_{CE} = 15\text{ V}, V_{GE} = 0\text{ V}, T_J = 175\text{ °C}$			20	μA
		$V_{CE} = 200\text{ V}, V_{GE} = 0\text{ V}, T_J = 175\text{ °C}$			100	μA
I_{GES}	Gate-emitter leakage current	$V_{GE} = \pm 10\text{ V}, V_{CE} = 0\text{ V}$		625		μA
		$V_{GE} = \pm 10\text{ V}, V_{CE} = 0\text{ V}, T_J = -40\text{ °C to }175\text{ °C}$	450		900	μA
R_{GE}	Gate emitter resistance		11	16	22	k Ω
R_G	Gate resistance			120		Ω

Table 4. Dynamic characteristics

Symbol	Parameter	Test conditions	Min.	Typ.	Max.	Unit
C_{ies}	Input capacitance	$V_{CE} = 25\text{ V}, f = 1\text{ MHz}, V_{GE} = 0\text{ V}$	-	1011	-	μF
C_{oes}	Output capacitance		-	87	-	
C_{res}	Reverse transfer capacitance		-	14	-	
Q_g	Total gate charge	$V_{CE} = 13\text{ V}, I_C = 10\text{ A}, V_{GE} = 0\text{ to }5\text{ V}$	-	26	-	nC

Table 5. Resistive load switching characteristics

Symbol	Parameter	Test conditions	Min.	Typ.	Max.	Unit
$t_{d(\text{on})}$	Turn-on delay time	$V_{CC} = 14\text{ V}, V_{GE} = 5\text{ V}, R_L = 1\text{ }\Omega, R_G = 1\text{ k}\Omega$	-	1.1	-	μs
t_r	Current rise time	(see Figure 17. Test circuit for resistive load switching)	-	3.6	-	μs
$t_{d(\text{on})}$	Turn-on delay time	$V_{CC} = 14\text{ V}, V_{GE} = 5\text{ V}, R_L = 1\text{ }\Omega, R_G = 1\text{ k}\Omega, T_J = 150\text{ °C}$	-	1.06	-	μs
t_r	Current rise time	(see Figure 17. Test circuit for resistive load switching)	-	3.5	-	μs

Table 6. Inductive load switching characteristics

Symbol	Parameter	Test conditions	Min.	Typ.	Max.	Unit
$t_{d(off)}$	Turn-off delay time	$V_{CC} = 300\text{ V}$, $L = 1\text{ mH}$, $I_C = 10\text{ A}$, $V_{GE} = 5\text{ V}$, $R_G = 1\text{ k}\Omega$	-	4.6	-	μs
t_f	Current fall time	(see Figure 16. Test circuit for inductive load switching)	-	8.4	-	μs
dV/dt	Turn-off voltage slope	(see Figure 16. Test circuit for inductive load switching)	-	165	-	V/ μs
$t_{d(off)}$	Turn-off delay time	$V_{CC} = 300\text{ V}$, $L = 1\text{ mH}$, $I_C = 10\text{ A}$, $V_{GE} = 5\text{ V}$, $R_G = 1\text{ k}\Omega$, $T_J = 150\text{ }^\circ\text{C}$	-	4.7	-	μs
t_f	Current fall time	(see Figure 16. Test circuit for inductive load switching)	-	9.8	-	μs
dV/dt	Turn-off voltage slope	(see Figure 16. Test circuit for inductive load switching)	-	122	-	V/ μs

2.1 Electrical characteristics (curves)

Figure 1. $V_{CE(sat)}$ vs. junction temperature ($I_C = 6\text{ A}$)

Figure 2. $V_{CE(sat)}$ vs. junction temperature ($I_C = 10\text{ A}$)

Figure 3. Self clamped inductive switching current

Figure 4. Output characteristics ($T_J = 25\text{ }^\circ\text{C}$)

Figure 5. Output characteristics ($T_J = -40\text{ }^\circ\text{C}$)

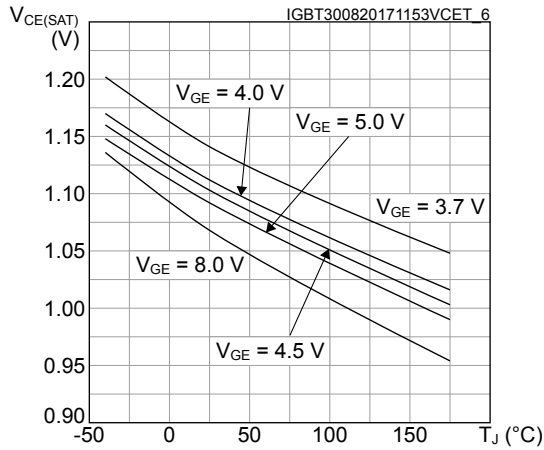
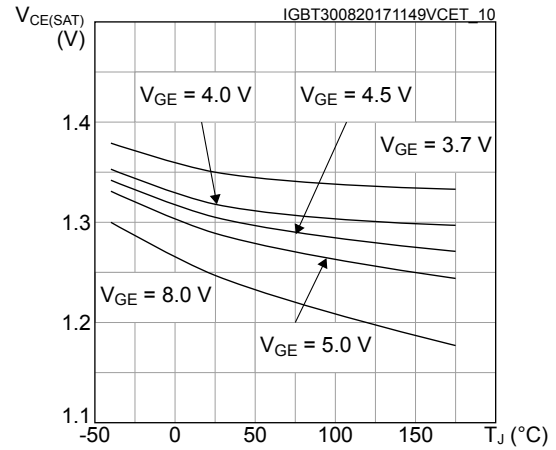
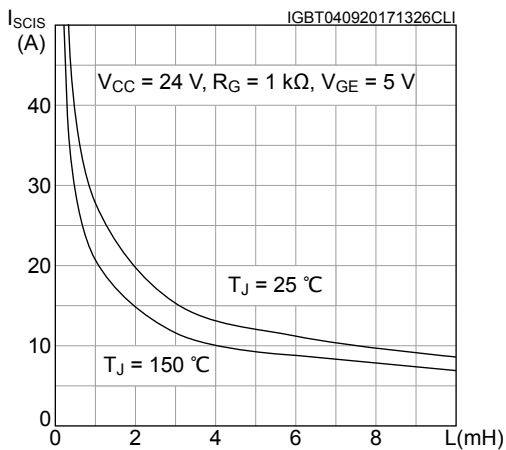
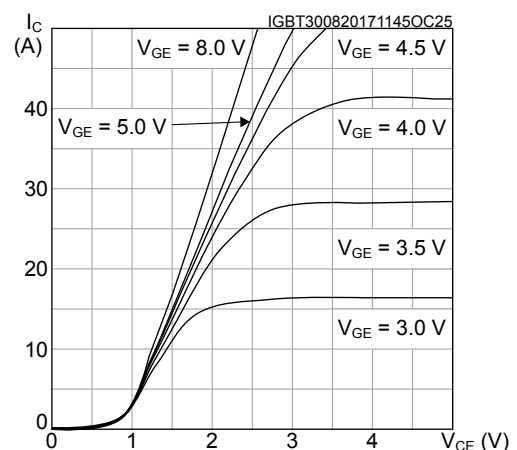
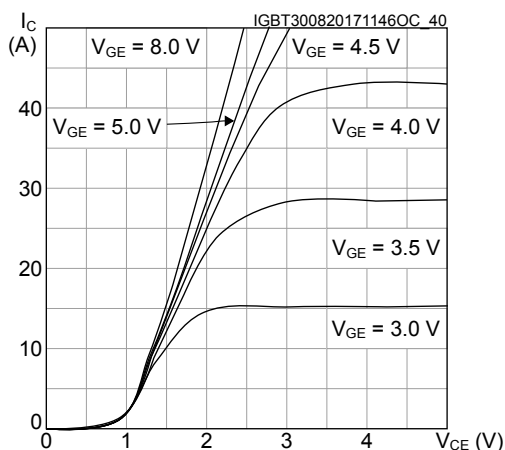
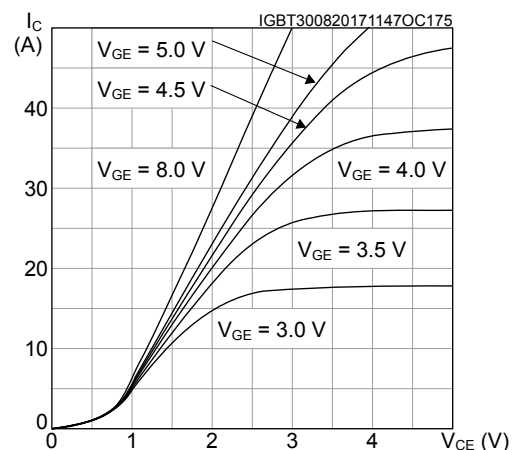
Figure 6. Output characteristics ($T_J = 175\text{ }^\circ\text{C}$)

Figure 7. Transfer characteristics

Figure 8. Collector current vs. case temperature

Figure 9. Leakage current vs. temperature

Figure 10. Normalized $V_{CES(\text{clamped})}$ vs. temperature

Figure 11. Normalized $V_{GE(\text{th})}$ vs. temperature

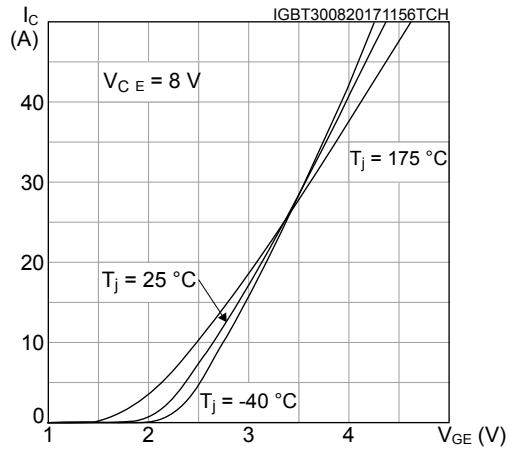
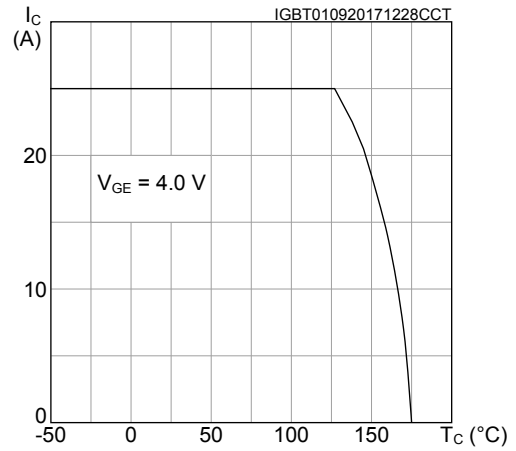
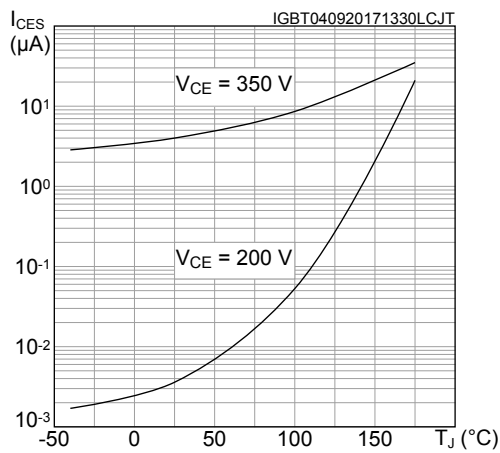
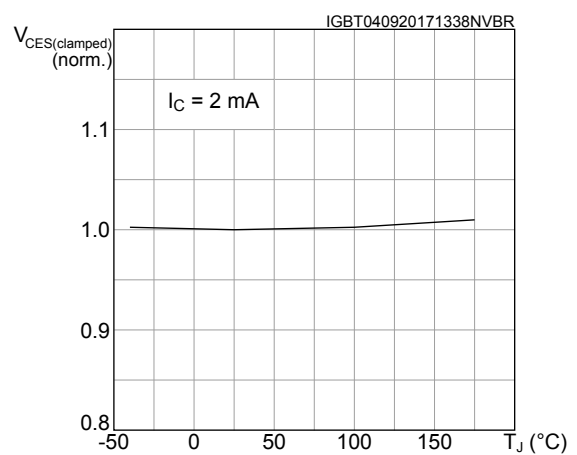
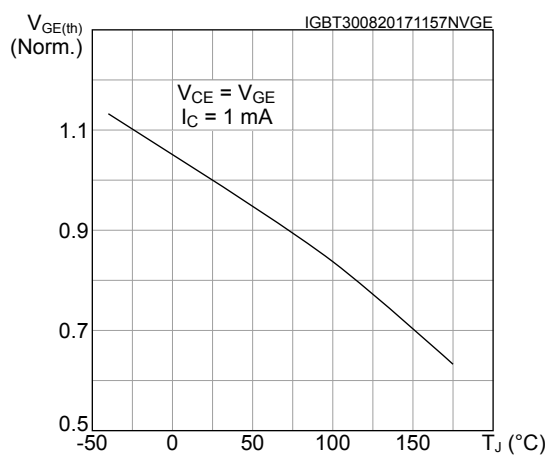
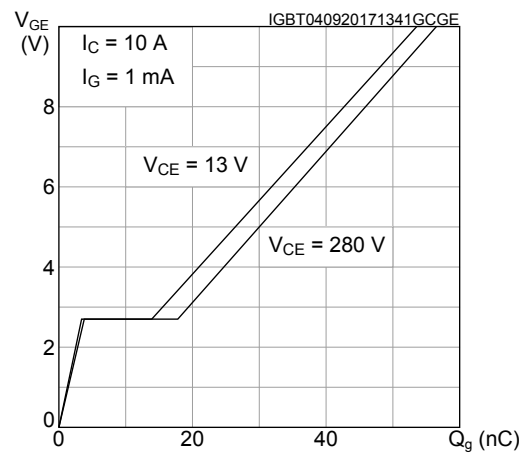
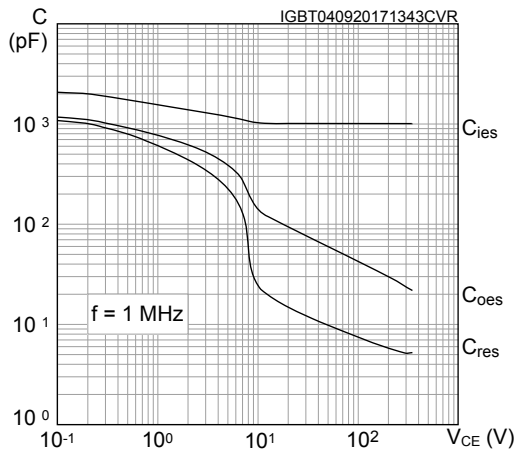
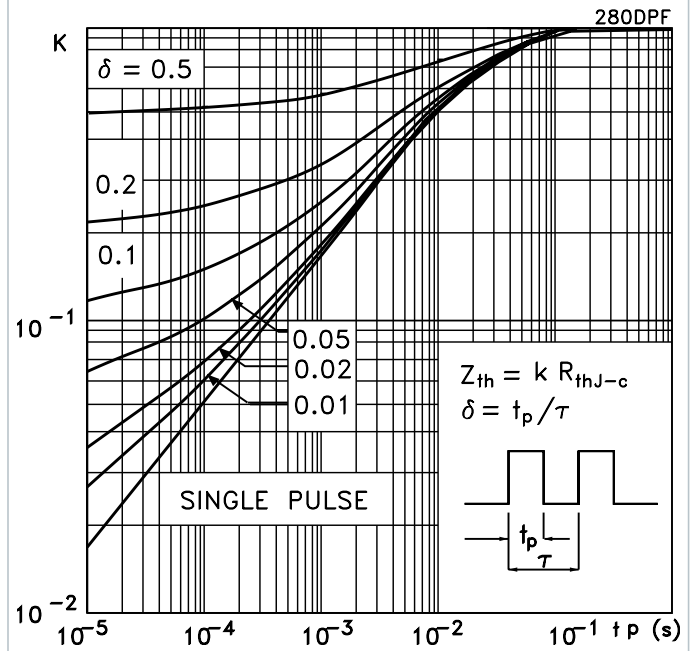
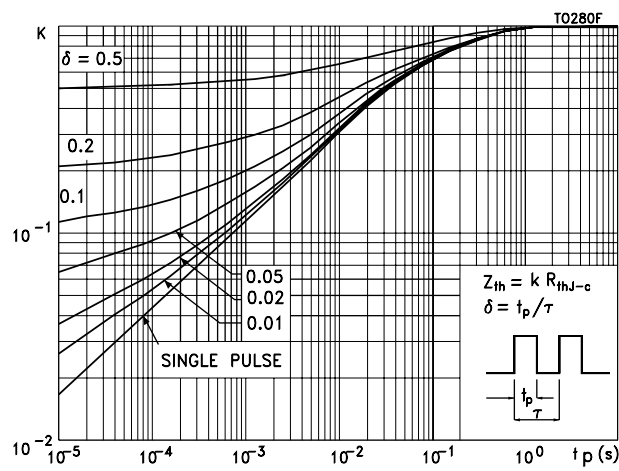
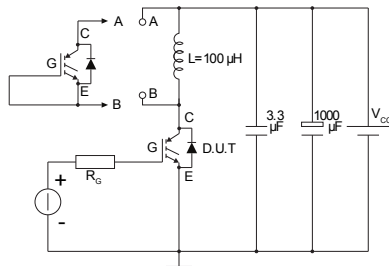
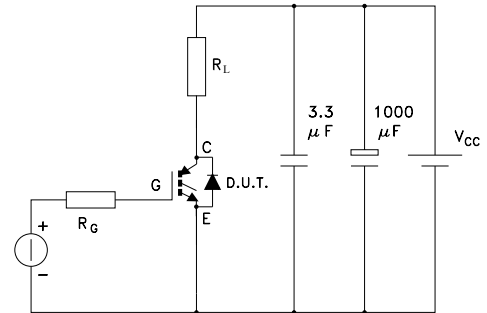
Figure 12. Gate charge vs. gate-emitter voltage

Figure 13. Capacitance variations

Figure 14. Thermal impedance for DPAK

Figure 15. Thermal impedance for D²PAK

3 Test circuits

Figure 16. Test circuit for inductive load switching

AM01504v1

Figure 17. Test circuit for resistive load switching

AM01504v2

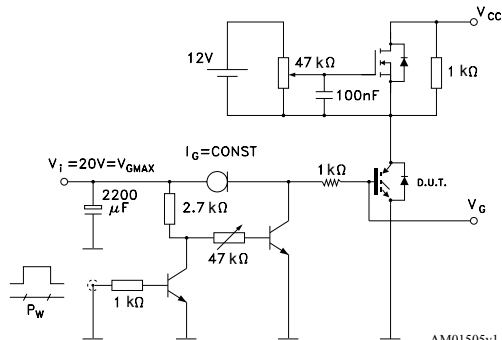
Figure 18. Gate charge test circuit

AM01505v1

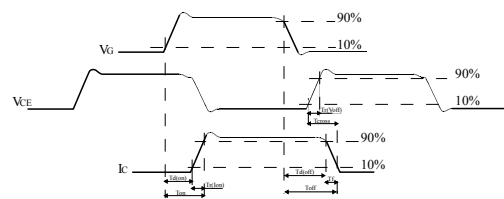
Figure 19. Switching waveform

AM01506v1

4 Package information

In order to meet environmental requirements, ST offers these devices in different grades of ECOPACK® packages, depending on their level of environmental compliance. ECOPACK® specifications, grade definitions and product status are available at: www.st.com. ECOPACK® is an ST trademark.

4.1 D²PAK (TO-263) type A package information

Figure 20. D²PAK (TO-263) type A package outline

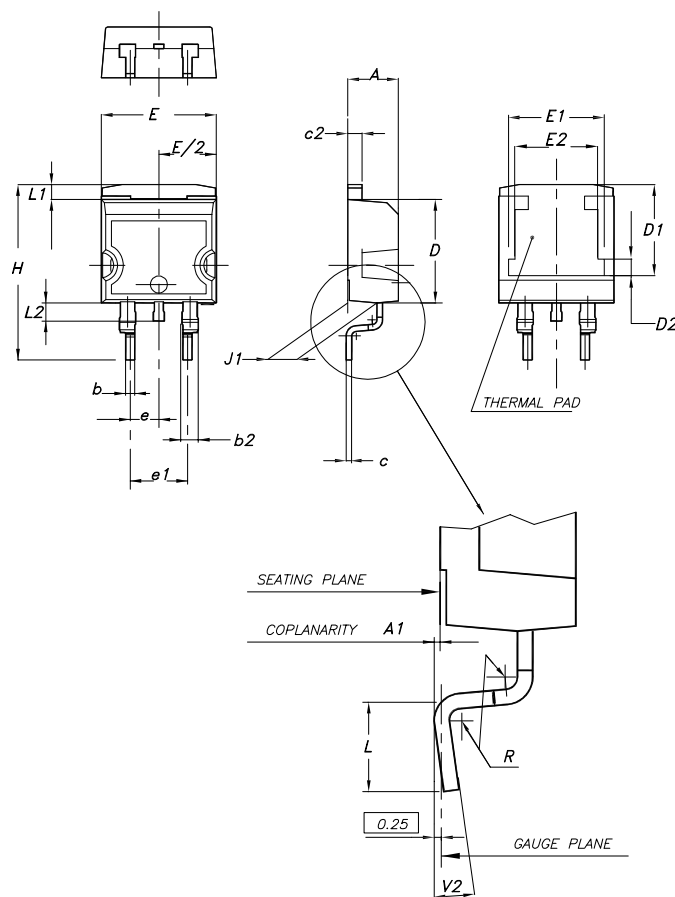

0079457_24

Table 7. D²PAK (TO-263) type A package mechanical data

Dim.	mm		
	Min.	Typ.	Max.
A	4.40		4.60
A1	0.03		0.23
b	0.70		0.93
b2	1.14		1.70
c	0.45		0.60

Dim.	mm		
	Min.	Typ.	Max.
c2	1.23		1.36
D	8.95		9.35
D1	7.50	7.75	8.00
D2	1.10	1.30	1.50
E	10.00		10.40
E1	8.50	8.70	8.90
E2	6.85	7.05	7.25
e		2.54	
e1	4.88		5.28
H	15.00		15.85
J1	2.49		2.69
L	2.29		2.79
L1	1.27		1.40
L2	1.30		1.75
R		0.40	
V2	0°		8°

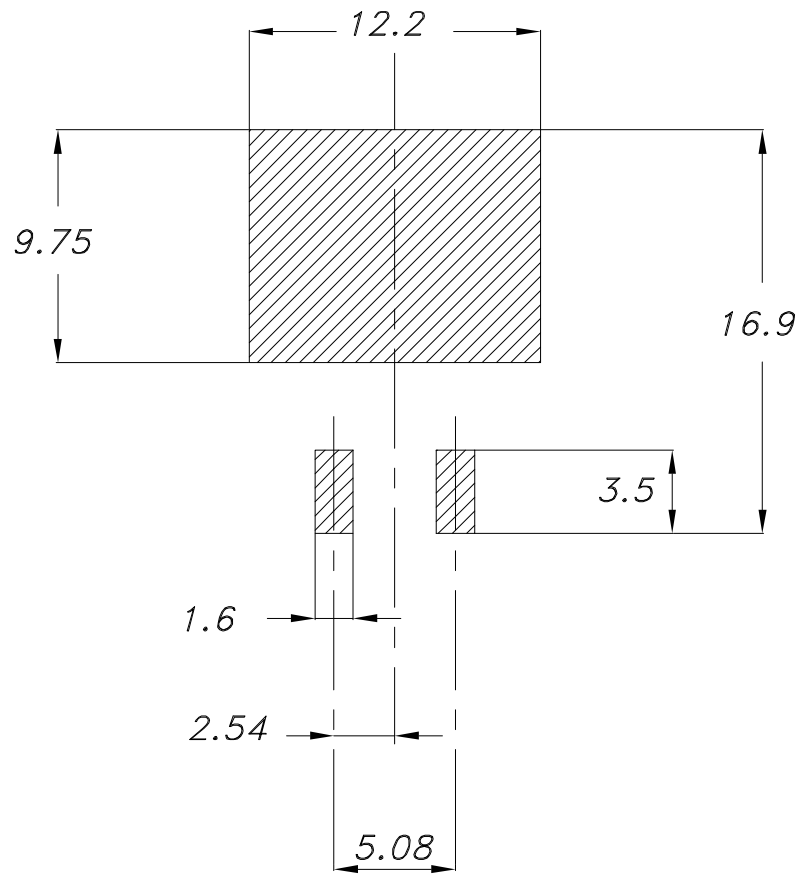
Figure 21. D²PAK (TO-263) recommended footprint (dimensions are in mm)

Footprint

4.2 DPAK (TO-252) type A2 package information
Figure 22. DPAK (TO-252) type A2 package outline

0068772_type-A2_rev24

Table 8. DPAK (TO-252) type A2 mechanical data

Dim.	mm		
	Min.	Typ.	Max.
A	2.20		2.40
A1	0.90		1.10
A2	0.03		0.23
b	0.64		0.90
b4	5.20		5.40
c	0.45		0.60
c2	0.48		0.60
D	6.00		6.20
D1	4.95	5.10	5.25
E	6.40		6.60
E1	5.10	5.20	5.30
e	2.16	2.28	2.40
e1	4.40		4.60
H	9.35		10.10
L	1.00		1.50
L1	2.60	2.80	3.00
L2	0.65	0.80	0.95
L4	0.60		1.00
R		0.20	
V2	0°		8°

Figure 23. DPAK (TO-252) recommended footprint (dimensions are in mm)

FP_0068772_24

4.3 D²PAK and DPAK packing information

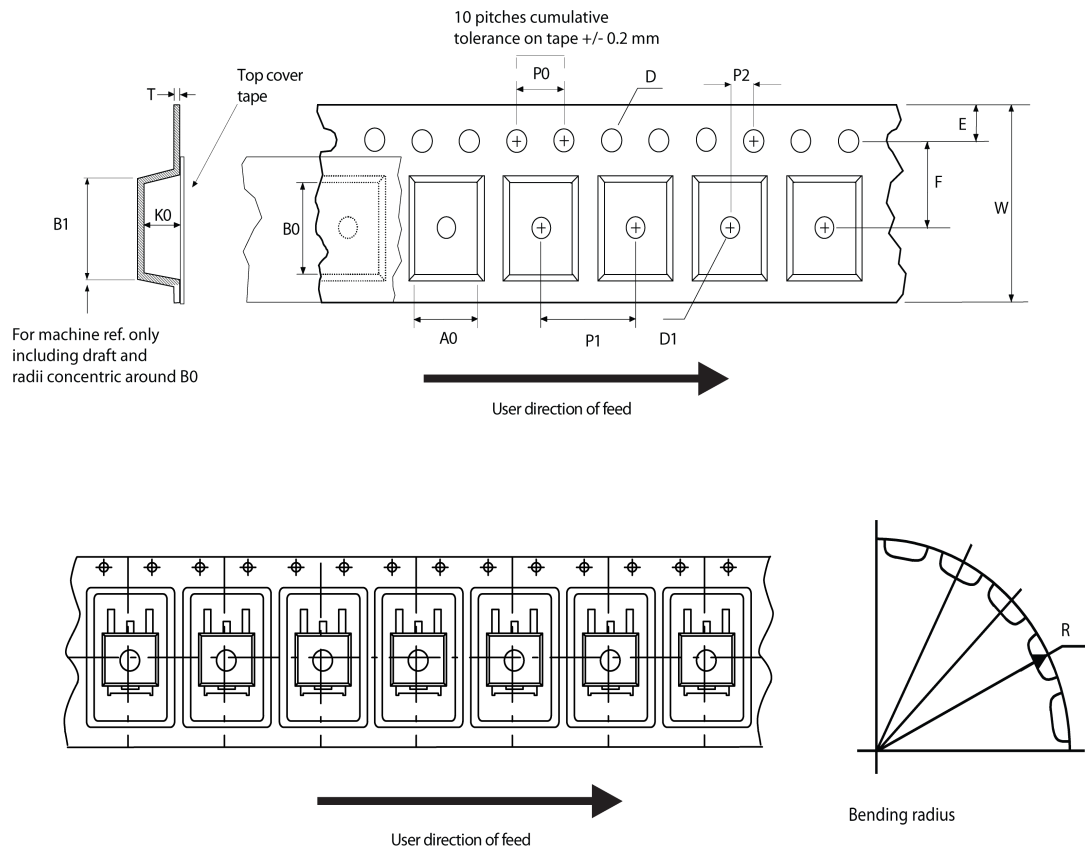
Figure 24. Tape outline

AM08852v1

Figure 25. Reel outline

AM06038v1

Table 9. D²PAK tape and reel mechanical data

Tape			Reel			
Dim.	mm		Dim.	mm		
	Min.	Max.		Min.	Max.	
A0	10.5	10.7	A		330	
B0	15.7	15.9	B	1.5		
D	1.5	1.6	C	12.8	13.2	
D1	1.59	1.61	D	20.2		
E	1.65	1.85	G	24.4	26.4	
F	11.4	11.6	N	100		
K0	4.8	5.0	T		30.4	
P0	3.9	4.1	Base quantity Bulk quantity			
P1	11.9	12.1				1000
P2	1.9	2.1				1000
R	50					
T	0.25	0.35				
W	23.7	24.3				

Table 10. DPAK tape and reel mechanical data

Tape			Reel		
Dim.	mm		Dim.	mm	
	Min.	Max.		Min.	Max.
A0	6.8	7	A		330
B0	10.4	10.6	B	1.5	
B1		12.1	C	12.8	13.2
D	1.5	1.6	D	20.2	
D1	1.5		G	16.4	18.4
E	1.65	1.85	N	50	
F	7.4	7.6	T		22.4
K0	2.55	2.75			
P0	3.9	4.1	Base qty.		2500
P1	7.9	8.1	Bulk qty.		2500
P2	1.9	2.1			
R	40				
T	0.25	0.35			
W	15.7	16.3			

Revision history

Table 11. Document revision history

Date	Revision	Changes
05-Sep-2017	1	First release.
11-Sep-2017	2	Modified Section 4.1: "D ² PAK (TO-263) type A package information". Minor text changes.
13-Feb-2018	3	Removed maturity status indication from cover page. Updated Table 1. Absolute maximum ratings , Table 2. Thermal data , Table 5. Resistive load switching characteristics and Table 6. Inductive load switching characteristics . Minor text changes.

Contents

1	Electrical ratings	2
2	Electrical characteristics	3
2.1	Electrical characteristics (curves)	5
3	Test circuits	8
4	Package information	9
4.1	D²PAK (TO-263) type A package information	9
4.2	DPAK (TO-252) type A2 package information	11
4.3	D²PAK and DPAK packing information	14
	Revision history	18
	Contents	19
	Disclaimer	20

IMPORTANT NOTICE – PLEASE READ CAREFULLY

STMicroelectronics NV and its subsidiaries (“ST”) reserve the right to make changes, corrections, enhancements, modifications, and improvements to ST products and/or to this document at any time without notice. Purchasers should obtain the latest relevant information on ST products before placing orders. ST products are sold pursuant to ST’s terms and conditions of sale in place at the time of order acknowledgement.

Purchasers are solely responsible for the choice, selection, and use of ST products and ST assumes no liability for application assistance or the design of Purchasers’ products.

No license, express or implied, to any intellectual property right is granted by ST herein.

Resale of ST products with provisions different from the information set forth herein shall void any warranty granted by ST for such product.

ST and the ST logo are trademarks of ST. All other product or service names are the property of their respective owners.

Information in this document supersedes and replaces information previously supplied in any prior versions of this document.

© 2018 STMicroelectronics – All rights reserved



Компания «ЭлектроПласт» предлагает заключение долгосрочных отношений при поставках импортных электронных компонентов на взаимовыгодных условиях!

Наши преимущества:

- Оперативные поставки широкого спектра электронных компонентов отечественного и импортного производства напрямую от производителей и с крупнейших мировых складов;
- Поставка более 17-ти миллионов наименований электронных компонентов;
- Поставка сложных, дефицитных, либо снятых с производства позиций;
- Оперативные сроки поставки под заказ (от 5 рабочих дней);
- Экспресс доставка в любую точку России;
- Техническая поддержка проекта, помощь в подборе аналогов, поставка прототипов;
- Система менеджмента качества сертифицирована по Международному стандарту ISO 9001;
- Лицензия ФСБ на осуществление работ с использованием сведений, составляющих государственную тайну;
- Поставка специализированных компонентов (Xilinx, Altera, Analog Devices, Intersil, Interpoint, Microsemi, Aeroflex, Peregrine, Syfer, Eurofarad, Texas Instrument, Miteq, Cobham, E2V, MA-COM, Hittite, Mini-Circuits, General Dynamics и др.);

Помимо этого, одним из направлений компании «ЭлектроПласт» является направление «Источники питания». Мы предлагаем Вам помощь Конструкторского отдела:

- Подбор оптимального решения, техническое обоснование при выборе компонента;
- Подбор аналогов;
- Консультации по применению компонента;
- Поставка образцов и прототипов;
- Техническая поддержка проекта;
- Защита от снятия компонента с производства.



Как с нами связаться

Телефон: 8 (812) 309 58 32 (многоканальный)

Факс: 8 (812) 320-02-42

Электронная почта: org@eplast1.ru

Адрес: 198099, г. Санкт-Петербург, ул. Калинина, дом 2, корпус 4, литера А.