

# General Specifications

Toggles

Rockers

Pushbuttons

Illuminated PB

Programmable

Keylocks

Rotaries

Slides

Tactiles

Tilt

Touch

Indicators

Accessories

Supplement

## Electrical Capacity (Resistive Load)

**Logic Level:** 0.4VA maximum @ 28V AC/DC maximum  
(Applicable Range 0.1mA ~ 0.1A @ 20mV ~ 28V)  
See Supplement section to find explanation of operating range

## Other Ratings

**Contact Resistance:** 80 milliohms maximum  
**Insulation Resistance:** 100 megohms minimum @ 500V DC  
**Dielectric Strength:** 500V AC minimum for 1 minute minimum  
**Mechanical Life:** 30,000 cycles minimum  
**Electrical Life:** 10,000 cycles minimum  
**Nominal Operating Torque:** .026Nm (.234 lb•in) for momentary action models  
.020Nm (.182 lb•in) for maintained action models  
**Contact Timing:** Break-before-make  
**Angle of Throw:** 90° for 2-position & 45° for 3-position

## Materials & Finishes

**Boot:** Polyvinyl chloride  
**Key:** Brass alloy with bright nickel plating;  
brass alloy with bright nickel plating & ABS resin handle  
**Tumbler Barrel:** Polyacetal  
**Bushing:** Zinc alloy with nickel plating  
**Bracket:** Steel with tin plating  
**Base:** Glass fiber reinforced polyamide  
**Movable Contactor:** Beryllium copper with gold plating  
**Stationary Contacts:** Copper with gold plating  
**Terminals:** Brass with tin plating

## Environmental Data

**Operating Temperature Range:** -25°C through +70°C (-13°F through +158°F)  
**Humidity:** 90 ~ 95% humidity for 240 hours @ 40°C (104°F)  
**Vibration:** 10 ~ 55Hz with peak-to-peak amplitude of 1.5mm traversing the frequency range & returning in 1 minute; 3 right angled directions for 2 hours  
**Shock:** 50G (490m/s<sup>2</sup>) acceleration (tested in 6 right angled directions, with 5 shocks in each direction)

## PCB Processing

**Soldering:** Wave Soldering recommended: See Profile B in Supplement section.  
Manual Soldering: See Profile B in Supplement section.  
**Cleaning:** Automated cleaning. Boot must be on switch during processing.  
See Cleaning specifications in Supplement section.

## Standards & Certifications

These SK Series devices have not been tested for UL recognition or CSA certification. These switches are designed for use in a low-voltage, low-current, logic-level circuit. When used as intended in a logic-level circuit, the results do not produce hazardous energy.

# Distinctive Characteristics

Sealed body construction plus disposable boot protect contacts and allow automated processing.

Molded-in terminals seal out flux, solvents, and other contaminants.

Short body size for space-saving, behind panel dimensions.

Detent mechanism, with its spring-operated steel ball, gives crisp, positive action for accurate switch setting.

Bifurcated, self-wiping contact mechanism provides unequalled logic-level reliability and smoother, positive detent actuation.

Crimped bracket legs ensure secure PCB mounting and prevent dislodging during automated wave soldering.

.100" x .100" (2.54mm x 2.54mm) terminal spacing conforms to standard PC board grid spacing.

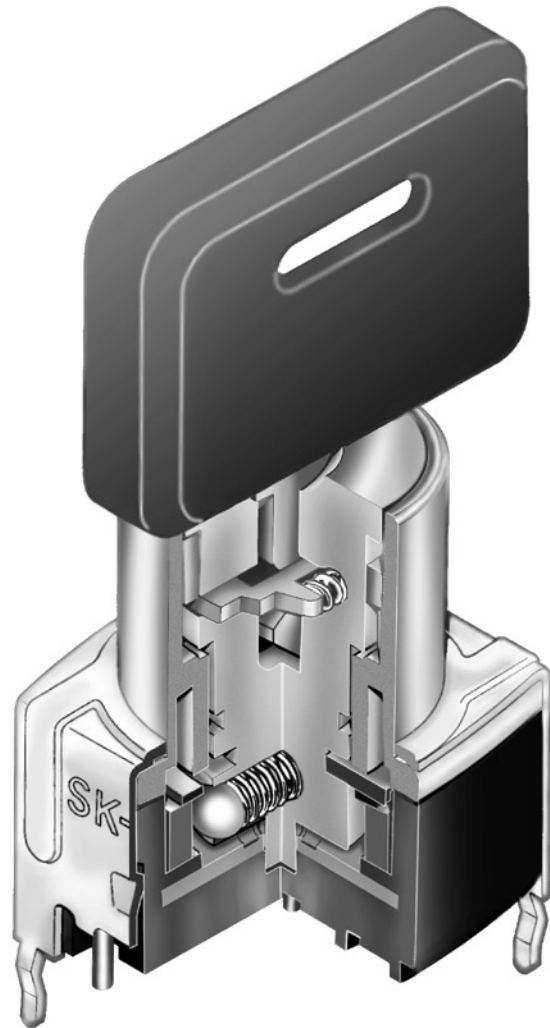

Actual Size

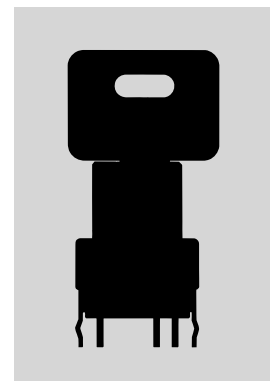

Toggles

Rockers

Pushbuttons

Illuminated PB

Programmable

**F** Keylocks

Rotaries

Slides

Tactiles

Tilt

Touch

Indicators

Accessories

Supplement

### TYPICAL SWITCH ORDERING EXAMPLE



### DESCRIPTION FOR TYPICAL ORDERING EXAMPLE

#### SK24EG30



## POLES, CIRCUITS & KEY-REMOVABLE POSITIONS

Pole & Throw	Model	Key Positions			Connected Terminals (Terminal numbers are not on switch)			Schematic	⊙ = Key Removable ● = Not Removable ✓ = Maximum Arc
		Pos 1	Pos 2	Pos 3	Pos 1	Pos 2	Pos 3		
SPDT	SK12A	ON	NONE	ON	C1-1	—	C1-2		
SPDT SPDT	SK12B SK15B	ON ON	NONE NONE	ON (ON)	C1-1	—	C1-2		
DPDT	SK22A	ON	NONE	ON	C1-1 C2-4	—	C1-2 C2-5		
DPDT DPDT	SK22B SK25B	ON ON	NONE NONE	ON (ON)	C1-1 C2-4	—	C1-2 C2-5		
SP3T	SK14D	ON	ON	ON	C1-1	C1-2	C1-3		
SP3T	SK14E	ON	ON	ON	C1-1	C1-2	C1-3		
DP3T	SK24D	ON	ON	ON	C1-1 C2-4	C1-2 C2-5	C1-3 C2-6		
DP3T	SK24E	ON	ON	ON	C1-1 C2-4	C1-2 C2-5	C1-3 C2-6		

## KEY REMOVABLE

**A** Positions 1 & 3  
90° Angular Throw

**B** Position 1  
90° Angular Throw

**D** Positions 1, 2 & 3  
45° Angular Throw

**E** Position 2  
45° Angular Throw

## CONTACT MATERIAL & RATING

**G** Gold over Copper

Logic Level

0.4VA maximum @ 28V AC/DC maximum

## TERMINALS

**13** Straight PC Terminals with Bracket

**30** Right Angle PC Terminals

Double Throw Model

Three Throw Model

Double Throw Model

Three Throw Model

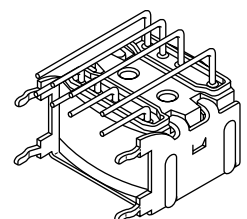
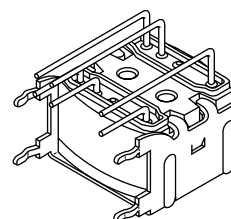
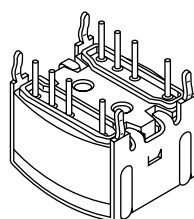
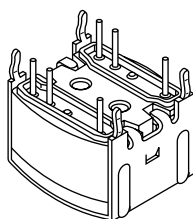

Toggle

Rockers

Pushbuttons

Programmable Illuminated PB

Keylocks

Rotaries

Slides

Tactiles

Tilt

Touch

Indicators

Accessories

Supplement

## KEYS

### AT4080 Standard Antistatic Plastic Handle

Brass Alloy with Bright Nickel Plating & ABS Resin Handle

2 keys supplied with each switch

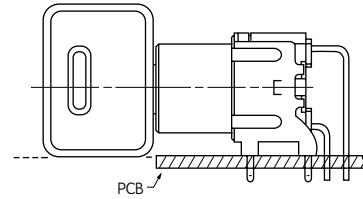
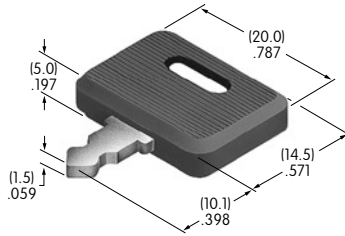

Suitable for all Straight PCB mount and for Right Angle PCB mount where clearance for key is obtainable.

### AT4079 for Right Angle Mid-board Mounting (Optional) All Metal

Brass Alloy with Bright Nickel Plating

Contact factory if metal keys needed

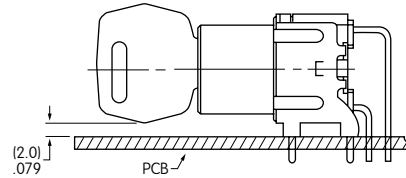
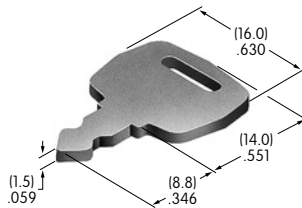

## TYPICAL SWITCH DIMENSIONS

### Straight PC with Bracket • Double Throw

### Single & Double Pole

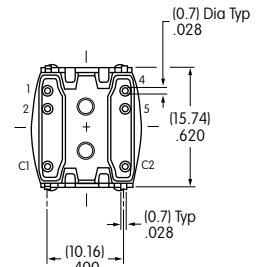
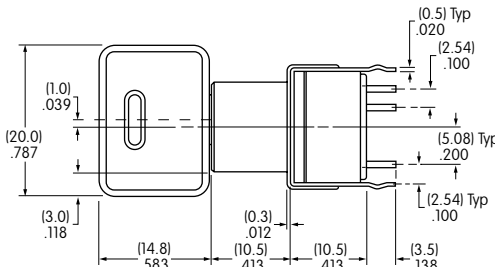
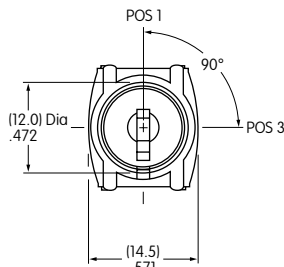

**SK12AG13**

Single Pole models have only terminals 1, 2 & C1

### Straight PC with Bracket • Three Throw

### Single & Double Pole

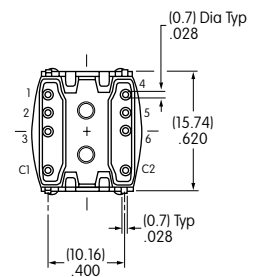
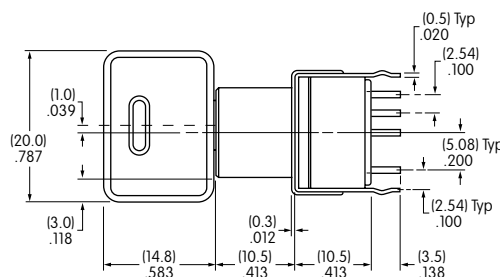
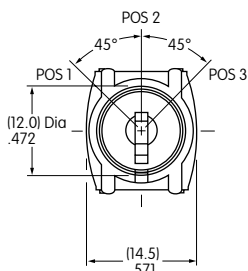

**SK24DG13**

Single Pole models have only terminals 1, 2, 3 & C1

## TYPICAL SWITCH DIMENSIONS

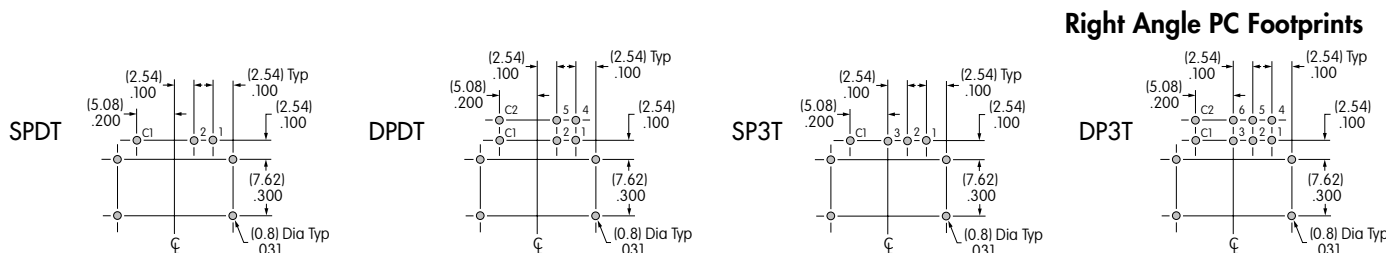
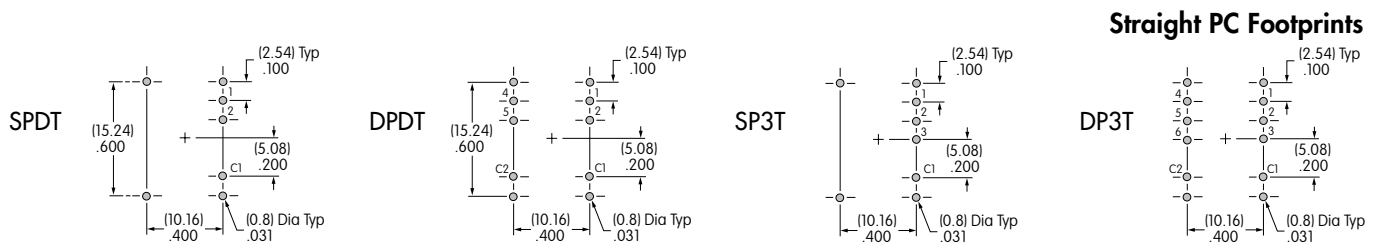
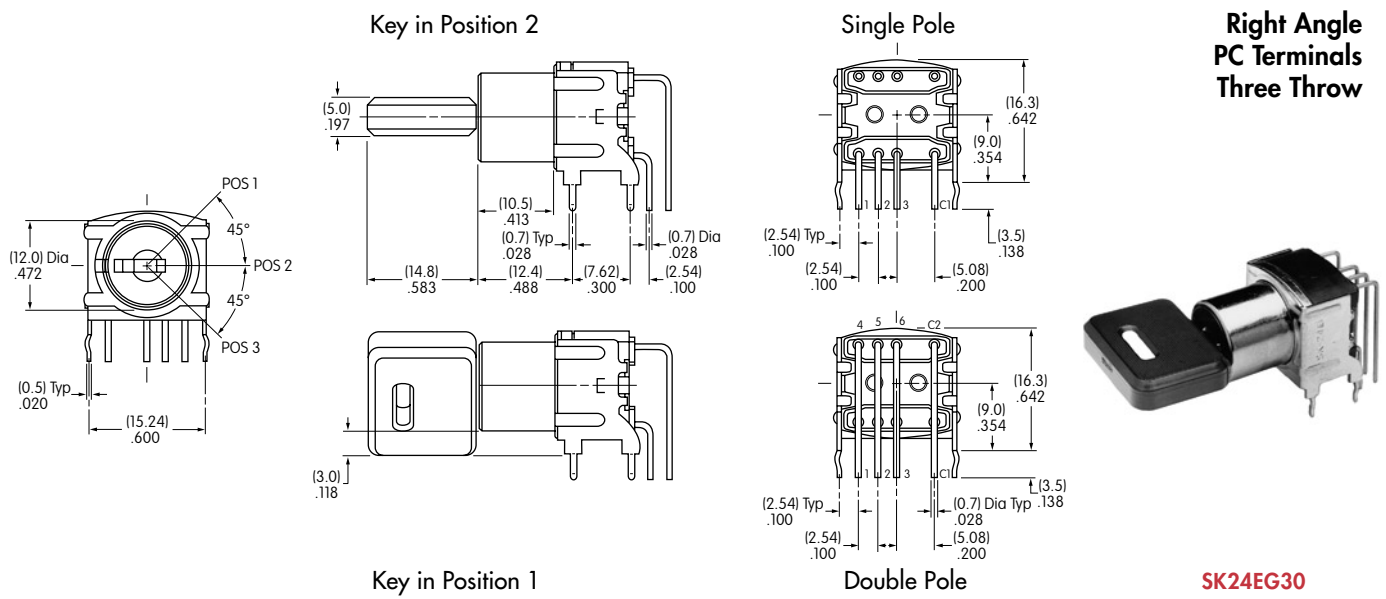
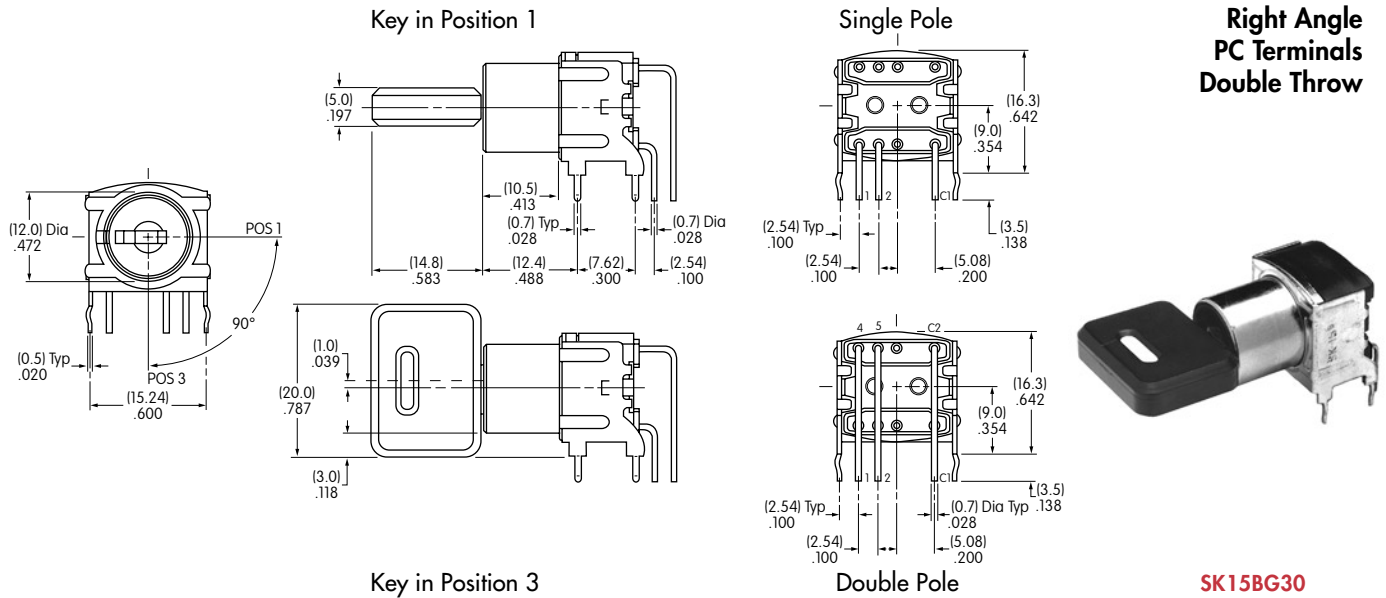



Компания «ЭлектроПласт» предлагает заключение долгосрочных отношений при поставках импортных электронных компонентов на взаимовыгодных условиях!

Наши преимущества:

- Оперативные поставки широкого спектра электронных компонентов отечественного и импортного производства напрямую от производителей и с крупнейших мировых складов;
- Поставка более 17-ти миллионов наименований электронных компонентов;
- Поставка сложных, дефицитных, либо снятых с производства позиций;
- Оперативные сроки поставки под заказ (от 5 рабочих дней);
- Экспресс доставка в любую точку России;
- Техническая поддержка проекта, помощь в подборе аналогов, поставка прототипов;
- Система менеджмента качества сертифицирована по Международному стандарту ISO 9001;
- Лицензия ФСБ на осуществление работ с использованием сведений, составляющих государственную тайну;
- Поставка специализированных компонентов (Xilinx, Altera, Analog Devices, Intersil, Interpoint, Microsemi, Aeroflex, Peregrine, Syfer, Eurofarad, Texas Instrument, Miteq, Cobham, E2V, MA-COM, Hittite, Mini-Circuits, General Dynamics и др.);

Помимо этого, одним из направлений компании «ЭлектроПласт» является направление «Источники питания». Мы предлагаем Вам помощь Конструкторского отдела:

- Подбор оптимального решения, техническое обоснование при выборе компонента;
- Подбор аналогов;
- Консультации по применению компонента;
- Поставка образцов и прототипов;
- Техническая поддержка проекта;
- Защита от снятия компонента с производства.



#### Как с нами связаться

**Телефон:** 8 (812) 309 58 32 (многоканальный)

**Факс:** 8 (812) 320-02-42

**Электронная почта:** [org@eplast1.ru](mailto:org@eplast1.ru)

**Адрес:** 198099, г. Санкт-Петербург, ул. Калинина, дом 2, корпус 4, литера А.